International Standard

ISO 14644

Cleanrooms

and associated controlled environments

Praphon Angtrakool
Food and Drug Administration



International Standard : ISO 14644

ISO 14644 consists of the following parts, under the general title Cleanrooms and associated controlled environments :

- ◆ Part 1 : Classification of air cleanliness
- ◆ Part 2 : Specifications for testing and monitoring to prove continued compliance with ISO 14644-1
- ◆ Part 3 : Test methods
- ◆ Part 4 : Design, construction and start-up
- ◆ Part 5 : Operation
- ◆ Part 6 : Vocabulary
- ◆ Part 7 : Separative devices (clean air hoods, gloveboxes, isolators and mini-environments)
- ◆ Part 8 : Classification of airborne molecular contamination

Why ISO 14644 ⁽¹⁾

PIC/S Guide to GMP (PE 009-5 1 August 2006)

Grade	At rest ^(b)		In operation ^(b)	
	Maximum permitted number of particles/m ³ Equal to or above ^(a)			
	0.5 μm ^(d)	5 μm	0.5 μm ^(d)	5 μm
A	3500	1 ^(e)	3500	1 ^(e)
B ^(c)	3500	1 ^(e)	350 000	2000
C ^(c)	350 000	2000	3 500 000	20 000
D ^(c)	3 500 000	20 000	Not defined ^(f)	Not defined ^(f)

Why ISO 14644 (2)

WHO Technical Report Series, No. 902, 2002 Annex 6

Grade	At rest		In operation	
	Maximum number of particles permitted/m ³		Maximum number of particles permitted/m ³	
	0.5 – 5.0 μm	> 5.0 μm	0.5 – 5.0 μm	> 5.0 μm
A	3500	0	3500	0
B	3500	0	350 000	2000
C	350 000	2000	3 500 000	20 000
D	3 500 000	20 000	Not defined	Not defined

Why ISO 14644 (3)

- ✦ PIC/S Guide to GMP (PE 009-5 1 August 2006)
 - ✦ (d) The guidance given for the maximum permitted number of particles in the “at rest” and “in operation” conditions correspond approximately to the cleanliness classes in the EN/ISO 14644-1 at a particle size of 0.5 µm.
- ✦ WHO Technical Report Series, No. 902, 2002
 - ✦ Detailed information on methods for determining the microbiological and particulate cleanliness of air, surfaces, etc. is not given here. Reference should be made to other guidelines published in compendia such as the European, Japanese or United States pharmacopoeias, or in documents issued by the European Committee for Standardization and the International Organization for Standardization (ISO).

Why ISO 14644 (4)

Table 1 - Air Classifications^a

Clean Area Classification (0.5 μm particles/ft ³)	ISO Designation ^b	> 0.5 μm particles/m ³	Microbiological Active Air Action Levels ^c (cfu/m ³)	Microbiological Settling Plates Action Levels ^{c,d} (diam. 90mm; cfu/4 hours)
100	5	3,520	1 ^e	1 ^e
1000	6	35,200	7	3
10,000	7	352,000	10	5
100,000	8	3,520,000	100	50

a All classifications based on data measured in the vicinity of exposed materials/articles during periods of activity.

b ISO 14644-1 designations provide uniform particle concentration values for cleanrooms in multiple industries.

An ISO 5 particle concentration is equal to Class 100 and approximately equals EU Grade A.

c Values represent recommended levels of environmental quality. You may find it appropriate to establish alternate microbiological action levels due to the nature of the operation or method of analysis.

d The additional use of settling plates is optional.

e Samples from Class 100 (ISO 5) environments should normally yield no microbiological contaminants.

From : Guidance for Industry Sterile Drug Products Produced by Aseptic Processing - Current Good Manufacturing Practice (US)

Sampling volume

PIC/S Guide to GMP (PE 009-5 1 August 2006)

Notes (a) : Particle measurement based on the use of a discrete airborne particle counter to measure the concentration of particles at designated sizes equal to or greater than the threshold stated. A continuous measurement system should be used for monitoring the concentration of particles in the grade A zone, and is recommended for the surrounding grade B areas. For routine testing the total sample volume should not be less than 1 m³ for grade A and B areas and preferably also in grade C areas.

ISO 14644 - 1

◆ Cleanroom

“A **room** in which the concentration of airborne particles is controlled, and which is constructed and used in a manner to minimize the introduction, generation, and retention of particles inside the room and in which other relevant **parameters**, e.g. **temperature, humidity, and pressure**, are controlled as necessary”

◆ Clean zone

“**dedicated space** in which the concentration of airborne particles is controlled, and which is constructed and used in a manner to minimize the introduction, generation, and retention of particles inside the zone, and in which other relevant **parameters**, e.g. **temperature, humidity, and pressure**, are controlled as necessary”

Note : This zone may be open or enclosed and may or may not be located within a cleanroom.

2.4 Occupancy states

- ◆ **as built** : condition where the installation is complete with all services connected and functioning but with no production equipment, materials, or personnel present
- ◆ **at rest** : condition where the installation is complete with equipment installed and operation in a manner agree upon by the customer and supplier, but with no personnel present
- ◆ **operational** : condition where the installation is functioning in the specified manner, with the specified number of personnel and working in the manner agreed upon

3.2 Classification number

$$C_n = 10^N \times \left[\frac{0.1}{D} \right]^{2.08} \quad (\text{Equation 1})$$

C_n represents the maximum permitted concentration (in particle/m³ of air) of airborne particles that are equal to or larger than the considered particle size; C_n is rounded to the nearest whole number

N is the ISO classification number, which shall not exceed the value of 9. Intermediate ISO classification numbers may be specified, with 0.1 the smallest permitted increment of N

D is the considered particle size in μm

0.1 is a constant with a dimension of μm

ISO airborne particulate cleanliness classes for cleanroom and clean zones

Classification numbers (N)	Maximum concentration limits (particles/m ³ of air) for particles equal to and larger than the considered sizes shown below					
	0.1 μm	0.2 μm	0.3 μm	0.5 μm	1 μm	5.0 μm
ISO Class 1	10	2				
ISO Class 2	100	24	10	4		
ISO Class 3	1000	237	102	35	8	
ISO Class 4	10 000	2370	1020	352	83	
ISO Class 5	100 000	23 700	10 200	3520	832	29
ISO Class 6	1 000 000	237 000	102 000	35 200	8320	293
ISO Class 7				352 000	83 200	2930
ISO Class 8				3 520 000	832 000	29 300
ISO Class 9				35 200 000	8 320 000	293 000

Recommended limits for microbiological monitoring of clean areas during operation⁽¹⁾

PIC/S Guide to GMP (PE 009-5 1 August 2006)

Grade	Recommended limits for microbial contamination ^(a)			
	Air sample cfu/m ³	Settle plates (diam. 90 mm) cfu/4 hours ^(b)	Contact plates (diam. 55 mm) cfu/plate	Glove print 5 fingers cfu/glove
A	< 1	< 1	< 1	< 1
B	10	5	5	5
C	100	50	25	-
D	200	100	50	-

Notes : (a) These are average values.

(b) Individual settle plates may be exposed for less than 4 hours.

Table 1 Limits for microbiological contamination ^a

WHO Technical Report Series, No. 902, 2002

Grade	Recommended limits for microbial contamination ^(a)			
	Air sample cfu/m ³	Settle plates (diam. 90 mm) cfu/4 hours ^(b)	Contact plates (diam. 55 mm) cfu/plate	Glove print 5 fingers cfu/glove
A	< 3	< 3	< 3	< 3
B	10	5	5	5
C	100	50	25	-
D	200	100	50	-

^a These are average values

^b The airborne particulate classification for the four grades is given in Table 2

^c Individual settles plates may be exposed for less than 4 hours

Table 1 Schedule of testing to demonstrate particle count compliance

Test Parameter	Cleanroom Class	Max. time interval	Test Procedure
Particle Count Test (Verification of Cleanliness)	≤ ISO 5	6 Months	ISO 14644-1 Annex B
	> ISO 5	12 Months	ISO 14644-1 Annex B

Note : This test will be performed in the operational state, but may also be performed in the at-rest state in accordance with the designated ISO classification.

3.3 Designation ⁽¹⁾

The designation of airborne particle cleanliness for cleanrooms and clean zones shall include :

- a) the **classification number**, expressed as “ISO Class N”
- b) the occupancy **state** to which the classification applies;
- c) the **considered particle size (s)**, and the related concentration (s), as determined by the classification equation (1) where each considered threshold particle size is in the range from 0.1 μm through 5 μm .

3.3 Designation ⁽²⁾

Example designation

- ❖ ISO class 4; operation state; considered sizes; 0.2 μm (2,370 particles/m³), 1 μm (83 particles/m³)
- ❖ The considered particle size(s) for which the concentration (s) will be measured shall be agreed upon by the customer and the supplier.
- ❖ If measurements are to be made at more than one considered particle size, each larger particle diameter (e.g., D₂) shall be at least 1.5 times the next smaller particle diameter (e.g., D₁)

e.g. : $D_2 \geq 1.5 D_1$

4.3 Airborne particle concentration limits

- ◆ Upon completion of testing in accordance with 4.2, **average particle concentrations and the 95 % upper confidence limit** (when applicable) shall be calculated using equations shown in **annex C**.
- ◆ **Average** particle concentration (s), calculated in accordance with equation (C.1), shall not exceed the concentration limit (s) determined by use of **equation (1)** in 3.2, as specified [3.3 c)] for the considered size (s)
- ◆ In addition, for situations in which **the number of sampling locations** involved is **at least two but not more than nine**, the calculation of **95 % upper confidence limits in accordance** with C.3 shall not exceed the concentration limits established above.

Algorithm for computation of average particle concentration at a location

$$\bar{X} = \frac{X_{i,1} + X_{i,2} + \dots + X_{i,n}}{n} \quad (\text{C.1})$$

\bar{X} is the average particle concentration at location I, representing any location.

$X_{i,1}$ to $X_{i,n}$ are the particle concentrations of the individual samples.

n is the number of samples taken at location i.

C.3.4 95% upper confidence limit (UCL) for overall mean

$$95 \% \text{ UCL} = \bar{\bar{X}} + t_{0.95} \left[\frac{s}{\sqrt{m}} \right] \quad (\text{C.4})$$

$t_{0.95}$ represents the 95th percentile (quantile) of the t distribution, with $m-1$ degrees of freedom

No. of individual averages (m)	2	3	4	5	6	7-9
t	6.3	2.9	2.4	2.1	2.0	1.9

Overall mean of the averages

$$\bar{\bar{X}} = \frac{\bar{X}_{i,1} + \bar{X}_{i,2} + \dots + \bar{X}_{i,m}}{m} \quad (\text{C.2})$$

$\bar{\bar{X}}$ is the overall mean of the location averages.

$\bar{X}_{i,1}$ to $\bar{X}_{i,m}$ are individual location averages, determined by using equation (C.1)

m is the number of individual location averages.

All individual location averages are equally weighted, regardless of the number of samples taken at any given location.

C.3.3 Standard deviation of the location averages (s)

Using equation (C.3), determine the standard deviation of the local averages.

$$s = \sqrt{\frac{(\bar{X}_{i,1} - \bar{X})^2 + (\bar{X}_{i,2} - \bar{X})^2 + \dots + (\bar{X}_{i,m} - \bar{X})^2}{(m-1)}} \quad (\text{C.3})$$

s is the standard deviation of the location averages.

$\bar{X}_{i,1}$ to $\bar{X}_{i,m}$ are individual location averages, determined by using equation (C.1)

\bar{X} is the overall mean of the location averages.

Establishment of sampling locations

- ◆ Derive the minimum number of sampling point locations from equation

$$N_L = \sqrt{A} \quad (B.1)$$

N_L is the minimum number of sampling locations (rounded up to a whole number)

A is the area of the cleanroom or clean zone in square meters.

- ◆ In the case of unidirectional horizontal airflow, the area A may be considered as the cross section of the moving air perpendicular to the direction of the airflow
- ◆ When only single location is sampled, or when more than nine are sampled, computing the 95 % upper confidence limit is not applicable.

B.4.2 Establishment of single sampling volume per location (1)

- ◆ At each sampling location, sample a sufficient volume of air that a **minimum of 20 particles** would be detected if the particle concentration for the **largest considered particle size** were at the class limit for the designated ISO class
- ◆ The single volume V_s per location is determined by using equation (B.2)

$$V_s = \frac{20}{C_{n,m}} \times 1,000 \quad (\text{B.2})$$

V_s is the minimum single sample volume per location, expressed in liters (except see B.4.2.2)

$C_{n,m}$ is the class limit (number of particles per cubic meter) for the largest considered particle size specified for the relevant class.

20 is the defined number of samples that could be counted if the particle concentration were at the class limit.

B.4.2 Establishment of single sampling volume per location (2)

Note : When V_s is very large, the time required for sampling can be substantial. By using the sequential sampling procedure (see annex F), both the require sample volume and time required to obtain samples may be reduced

B.4.2.2

- ◆ The volume sampled at each location shall be at least 2 liters, with the minimum sampling time at each location of 1 minute.

B.5.2 Requirement for computing the 95 % UCL

B.5.2.1

- ◆ When the number of locations sampled is more than one and less than ten, compute the overall mean of averages, standard deviation, and 95 % upper confidence limit from the average particle concentrations for all locations (B.5.1) following the procedure described in C.3

B.5.2.2

- ◆ When only a single location is sampled, or when more than nine are sampled, computing the 95 % upper confidence limit is not applicable.

B.6 Interpretation of results ⁽¹⁾

B.6.1 Classification requirements

- ◆ The cleanroom or clean zone is deemed to have met the specified air cleanliness classification if the averages of the particle concentrations measured at each of the locations and, when applicable, the 95% upper confidence limit calculated according to B.5.2, do not exceed the concentration limits determined in accordance with equation (1) of 3.2.
- ◆ If the results of testing fail to meet the specified air cleanliness classification, testing may be performed at additional, evenly distributed sampling locations, The results of recalculation, including data from the added locations, shall be definitive

B.6 Interpretation of results ⁽²⁾

B.6.2 Treatment of outliers

- ◆ The result of the 95% UCL calculation may fail to meet the specified ISO class designation. If the noncompliance is caused by a single, nonrandom “outlier” value resulting from an erroneous measurement (due to procedural error or equipment malfunction) or from an unusually low particle concentration (due to exceptionally clean air), the outlier may be excluded from the calculation, provided that:

B.6 Interpretation of results ⁽³⁾

B.6.2 Treatment of outliers (cont.)

- ✦ the calculation is repeated, including all remaining sampling locations;
- ✦ at least three measurement values remain in the calculation;
- ✦ no more than one measurement value is excluded from the calculation;
- ✦ the suspected cause of the erroneous measurement or low particle concentration is documented and accepted by both the customer and supplier.

NOTE Widely divergent values for particle concentrations among the locations sampled may be reasonable and even intentional, depending on the nature of the application of the clean installation under test.

D.1 Example 1 ⁽¹⁾

D.1.1 The cleanroom under consideration has an area (A) of 80 m.² Conformance with the specified airborne particulate cleanliness classification is to be determined the operational state.

The specified air cleanliness of the cleanroom is ISO Class 5.

D.1.2 Two considered particle sized are specified: 0.3 µm (D1) and 0.5 µm (D2)

a) Both particle sizes are within the size limitations for ISO Class 5 [see 3.3 c) and Table 1]: $0.1 \mu\text{m} \leq 0.3 \mu\text{m}$, $0.5 \mu\text{m} \leq 5 \mu\text{m}$

b) Application of the particle size ratio requirement, $D2 \geq 1.5 \times D1$ [see 3.3c)], shows complication : $0.5 \mu\text{m} \geq (1.5 \times 0.3 \mu\text{m} = 0.45 \mu\text{m})$.

D.1 Example 1 ⁽²⁾

D.1.3 The maximum permitted airborne particle concentration are calculated in accordance with equation (1) (see 3.2).

For particles $\geq 0.3 \mu\text{m}$ (D1) :

$$C_n = \left(\frac{0.1}{0.3} \right)^{2.08} \times 10^5 = 10176 \quad (\text{D.1})$$

rounded to 10 200 particles/m³

For particles $\geq 0.5 \mu\text{m}$ (D2) :

$$C_n = \left(\frac{0.1}{0.5} \right)^{2.08} \times 10^5 = 3517 \quad (\text{D.2})$$

rounded to 3 520 particles/m³

D.1 Example 1 ⁽³⁾

D.1.4 The number of sampling point locations are derived in accordance with equation (B.1) (see B.4.1.1):

$$NL = \sqrt{A} = \sqrt{80} = 8.94$$

(round to 9) (D.3)

Therefore the minimum number of sampling locations is **nine** and, as the number of sampling locations is less than ten, the calculation of **the 95% UCL** according to annex C is applicable.

D.1 Example 1 ⁽⁴⁾

D.1.5 The single sample volume, V_s , is calculated in litres in accordance with equation (B.2) (see B.4.2.1):

$$\begin{aligned} V_s &= \frac{20}{C_{n,m}} \times 1000 \\ &= \frac{20}{3517} \times 1000 && \text{(D.4)} \\ &= 5.69 \text{ litres} \end{aligned}$$

The result is greater than 2 litres, and the sample volume selected was 28 litres over a period of 1 min (a flow rate commonly available in discrete-particle-counting light-scattering-instruments).

- a) $V_s > 2$ litres (see B.4.2.2)
- b) $C_{n,m} > 20$ particles/ m^3 (see B.4.2.1)
- c) Sampling time ≥ 1 min (see B.4.2.2)

D.1 Example 1 ⁽⁵⁾

D.1.6 At each sampling location, only one single sample volume (28 litres) is taken(B.4.2.1). The counts obtained in from the measurements are recorded (B.5.1.1) below.

sampling location	number of particles ($\geq 0.3 \mu\text{m}$)	Number of particles ($\geq 0.5 \mu\text{m}$)
1	245	21
2	185	24
3	59	0
4	106	7
5	164	22
6	196	25
7	226	23
8	224	37
9	195	19

D.1 Example 1 ⁽⁶⁾

D.1.7 From the raw data (D.1.6), the number of particles per cubic metre, x_1 , is calculated:

sampling location	$x_1 \geq 0.3 \mu\text{m}$	$x_1 \geq 0.5 \mu\text{m}$
1	8750	750
2	6607	857
3	2107	0
4	3786	250
5	5857	786
6	7000	893
7	8071	821
8	8000	1321
9	6964	679

D.1 Example 1 ⁽⁷⁾

- ❖ Each calculated concentration value for 0.3 μm and 0.5 μm is less than the limits established in D.1.3.
- ❖ This satisfies the first part of classification (B.6.1) and therefore calculation of the 95% UCL according to annex C can proceed.

D.1.8 Computation of average concentration in accordance with equation (C.1) (see C.2) is not applicable, as the sample volumes taken were single volumes which represent an average particle concentration at each location. The overall means of the averages are calculated in accordance with equation (C.2) (see C.3.2).

D.1 Example 1 ⁽⁸⁾

For particles $\geq 0.3 \mu\text{m}$:

$$\bar{X} = \frac{1}{9} \left(\begin{array}{l} 8750 + 6607 + 2107 + 3786 + 5857 \\ + 7000 + 8071 + 8000 + 6964 \end{array} \right) \quad (\text{D.5})$$

$$= \frac{1}{9} \times 57142$$

$$= 6349.1 \quad \text{rounded to} \quad 6349 \quad \text{particles/m}^3$$

For particles $\geq 0.5 \mu\text{m}$:

$$\bar{X} = \frac{1}{9} \left(\begin{array}{l} 750 + 857 + 0 + 250 + 786 \\ + 893 + 821 + 1321 + 679 \end{array} \right) \quad (\text{D.6})$$

$$= \frac{1}{9} \times 6357$$

$$= 706.3 \quad \text{rounded to} \quad 706 \quad \text{particles/m}^3$$

D.1 Example 1 ⁽⁹⁾

D.1.9 The standard deviations of the location averages are calculated in accordance with equation (C.3) (see C.3.3).

For particles $\geq 0,3 \mu\text{m}$:

$$s^2 = \frac{1}{8} \left(\begin{array}{l} (8750-6349)^2 + (6607-6349)^2 + (2107-6349)^2 + \\ (3786-6349)^2 + (5857-6349)^2 + (7000-6349)^2 + \\ (8071-6349)^2 + (8000-6349)^2 + (6964-6349)^2 \end{array} \right) \quad (\text{D.7})$$

$$= \frac{1}{8} \times 37130073$$

$$= 4641259.1 \quad \text{rounded to } 4\,641\,259$$

$$s = \sqrt{4\,641\,259} \quad (\text{D.8})$$

$$= 2154.4 \quad \text{rounded to } 2154 \text{ particles/m}^3$$

D.1 Example 1 (10)

For particles $\geq 0,5 \mu\text{m}$:

$$s^2 = \frac{1}{8} \left[\begin{aligned} &(750-706)^2 + (857-706)^2 + (0-706)^2 + (250-706)^2 \\ &+ (786-706)^2 + (893-706)^2 + (821-706)^2 + \\ &(1321-706)^2 + (679-706)^2 \end{aligned} \right] \quad (\text{D.9})$$

$$= \frac{1}{8} \times 1164\,657$$

$$= 145582.1 \quad \text{rounded to} \quad 145582$$

$$s = \sqrt{145\,582} \quad (\text{D.10})$$

$$= 381.6 \quad \text{rounded to} \quad 382 \text{ particles/m}^3$$

D.1 Example 1 (11)

D.1.10 The 95% upper confidence limits (UCL) are calculated in accordance with equation (C.4) (see C.3.4). As the number of individual average is $m = 9$, the t distribution taken from Table C.1 is $t = 1.9$.

$$\begin{aligned} 95\% \text{ UCL } (\geq 0.3 \mu\text{m}) &= 6349 + 1.9 \left(\frac{2154}{\sqrt{9}} \right) \\ &= 7713.2 \text{ rounded to } 7713 \text{ particles/m}^3 \quad (\text{D.11}) \end{aligned}$$

$$\begin{aligned} 95\% \text{ UCL } (\geq 0.5 \mu\text{m}) &= 706 + 1.9 \left(\frac{382}{\sqrt{9}} \right) \\ &= 947.9 \text{ rounded to } 948 \text{ particles/m}^3 \quad (\text{D.12}) \end{aligned}$$

D.1 Example 1 ⁽¹²⁾

D.1.11 The interpretation of results is carried out according to B.6.1. In D.1.7, it was shown that particle concentration of each single sample volume is less than the specified class limits. In D.1.10, it was shown that the calculated values of the 95% UCL are also less than the class limits established in D.1.3.

Therefore the airborne particulate cleanliness of the cleanroom meets the required classification.

D.1 Example 2⁽¹⁾

D.2.1 This example is constructed to show the influence of the 95% UCL calculations on the results.

A cleanroom is specified for a particulate cleanliness of ISO Class 3 in operation. The number of sampling locations has been determined to be five. As the number of sampling locations is more than one less than ten, the calculation of the 95% UCL according to annex C is applicable.

Only one particle size ($D \geq 0.1 \mu\text{m}$) is considered.

D.2.2 The particle concentration limit for ISO Class 3 at $\geq 0.1 \mu\text{m}$ is taken from Table 1:

$$C_n (\geq 0.1 \mu\text{m}) = 1000 \text{ particles/m}^3$$

D.1 Example 2⁽²⁾

D.2.3 At each sampling location, only one single sample volume is taken (B.5.1.1). The number of particles per cubic metre, x_1 , is calculated for each location and recorded below:

Sampling location	$x_1 \geq 0.1 \mu\text{m}$
1	926
2	958
3	937
4	963
5	214

Each value of the concentration for $D = 0.1 \mu\text{m}$ is less than the limit established in D.2.2. This result satisfies the first part of classification (B.6.1) and therefore calculation of the 95% UCL according to annex C can proceed.

D.1 Example 2⁽³⁾

D.2.4 The overall mean of the averages is calculated in accordance with equation (C.2) (see C.3.2):

$$\begin{aligned}\bar{x} &= \frac{1}{5} (926 + 958 + 937 + 963 + 214) \\ &= \frac{1}{5} \times 3998 \\ &= 799.6 \text{ rounded to } 800 \text{ particles/m}^3\end{aligned}\tag{D.13}$$

D.2.5 The standard deviation of the location averages is calculated in accordance with equation (C.3) (see C.3.3)

$$\begin{aligned}s^2 &= \frac{1}{4} \left[(926-800)^2 + (958-800)^2 + (937-800)^2 \right. \\ &\quad \left. + (963-800)^2 + (214-800)^2 \right] \\ &= \frac{1}{4} \times 429574 \\ &= 107393.5 \text{ rounded to } 107394\end{aligned}\tag{D.14}$$

$$s = \sqrt{107394} = 327.7 \text{ rounded to } 328 \text{ particles/m}^3\tag{D.15}$$

D.1 Example 2₍₄₎

D.2.6 The 95% UCL is calculated in accordance with equation (C.4) (see C.3.4):

As the number of individual averages is $m = 5$, the t distribution taken from Table C.1 is $t = 2.1$.

$$\begin{aligned} 95 \% \text{ UCL} &= 800 + 2.1 \left(\frac{328}{\sqrt{5}} \right) && \text{(D.16)} \\ &= 1108 \text{ particles/m}^3 \end{aligned}$$

D.2.7 The particle concentrations of all of the single sample volumes are less than the specified classification limit (D.2.2)

D.1 Example 2⁽⁵⁾

Calculation of the 95% upper confidence limit shows, however, that the airborne particulate cleanliness of the cleanroom does not meet the specified classification.

This constructed example demonstrate the effect of a single outlying low particle concentration (i.e. location 5) on the result of the 95% UCL test

Because nonconformance of the air cleanliness classification results from application of the 95% UCL, and is caused by a single, low particle concentration, the procedure described in B.6.2 may be followed to determine whether the nonconformance can be waived

Sampling time (1)

Classification numbers (N)	Sampling time in minutes at sampling flow rate 28.3 L/min					
	0.1 μm	0.2 μm	0.3 μm	0.5 μm	1 μm	5.0 μm
ISO Class 1	71	354				
ISO Class 2	8	30	71	177		
ISO Class 3	1	3	7	21	89	
ISO Class 4	1	1	1	2	9	
ISO Class 5	1	1	1	1	1	25
ISO Class 6	1	1	1	1	1	3
ISO Class 7				1	1	1
ISO Class 8				1	1	1
ISO Class 9				1	1	

Sampling time ⁽²⁾

PIC/S Guide to GMP (PE 009-5 1 August 2006)

- ✦ For routine testing the total sample volume should not be less than 1 m³ for grade A and B areas and preferably also in grade C areas.

- ✦ Portable Particle Counters (flow rate 28.3 L/min)

Sampling time = 35 minutes

- ✦ Handheld Particle Counters (flow rate 2.8 L/min)

Sampling time = 357 minutes

Table 2 Schedule of additional tests for all classes ⁽¹⁾

Test Parameter	Cleanroom Class	Max. Time Interval	Test Procedure
Airflow Velocity	All Classes	12 Months	ISO 14644-3 Annex B4
Airflow Volume ⁽²⁾	All Classes	12 Months	ISO 14644-3 Annex B4
Air Pressure Difference ⁽³⁾	All Classes	12 Months	ISO 14644-3 Annex B5

- (1) This test will normally be performed in the operational state, but may also be performed in the at-rest state in accordance with the designated ISO classification.
- (2) Airflow volume may be determined by either airflow velocity or airflow volume measurement techniques.
- (3) This test will not apply to clean zones which are not totally enclosed.

Table A.1 Schedule of optional test

Test Parameter	Cleanroom Class	Max. Time Interval	Test Procedure
Installed filter leakage	All Classes	24 Months	ISO 14644-3 Annex B6
Airflow Visualization	All Classes	24 Months	ISO 14644-3 Annex B7
Recovery	All Classes	24 Months	ISO 14644-3 Annex B13
Containment leakage	All Classes	24 Months	ISO 14644-3 Annex B4

In addition to the normative tests specified in Table 1 and 2, optional test, such as those listed in Table A.1 may be included within the testing schedule

Guidance on the influence of risk assessment on cleanroom tests and monitoring

The risk assessment pertaining to a particular cleanroom application will affect the following :

- a) The monitoring plan.
- b) The interpretation of monitoring data.
- c) The actions to be taken as a result of the monitoring data obtained.
- d) The selection of parameters to be measured from Table 2.
- e) The selection of parameters to be measured from Table 1.

4.4 Test report

Test report shall include the following :

- ◆ The name and address of **the testing organization**, and **date** on which the test was performed;
- ◆ The number and year of **publication** of this part of ISO 14644. i.e. ISO 14644 -1 : date of current issue;
- ◆ A clear identification of physical **location** of cleanroom or clean zone tested (include reference to adjacent areas if necessary), and specific designations for coordinates of all sampling locations;
- ◆ The **specific designation criteria** for the cleanroom or clean zone, include the ISO classification, the relevant occupancy state (s), and the considered particle size (s)
- ◆ Details of the test method used, with any special conditions relating to the test or departures from the test method, and identification of the test instrument and its current calibration certificate;
- ◆ The **test results**, including particle concentration data for all sampling location coordinates.

ISO 14644-4

Part 4 : Design, construction and start-up

- ✦ Annex A : Control and segregation concepts (informative)
- ✦ Annex B : Classification examples (informative)
- ✦ Annex C : Approval of an installation (informative)
- ✦ Annex D : Layout of an installation (informative)
- ✦ Annex E : Construction and materials (informative)
- ✦ Annex F : Environmental control of cleanroom (informative)
- ✦ Annex G : Control of air cleanliness (informative)
- ✦ Annex H : Additional specification of requirements to be agreed upon between purchaser/user and designer/supplier (informative)

Control and segregation concepts ⁽¹⁾

A.1 Contamination control zones

- ❖ For economic, technical and operational reasons, clean zones are **often enclosed or surrounded** by further zones of lower cleanliness classification.
- ❖ This can allow the zones with the highest cleanliness demands to be reduced to the minimum size.
- ❖ **Movement of material and personnel** between adjacent clean zones gives rise to the risk of contamination transfer, therefore special attention should be paid to the detailed layout and management of material and personnel flow.

Shell-like contamination control concept

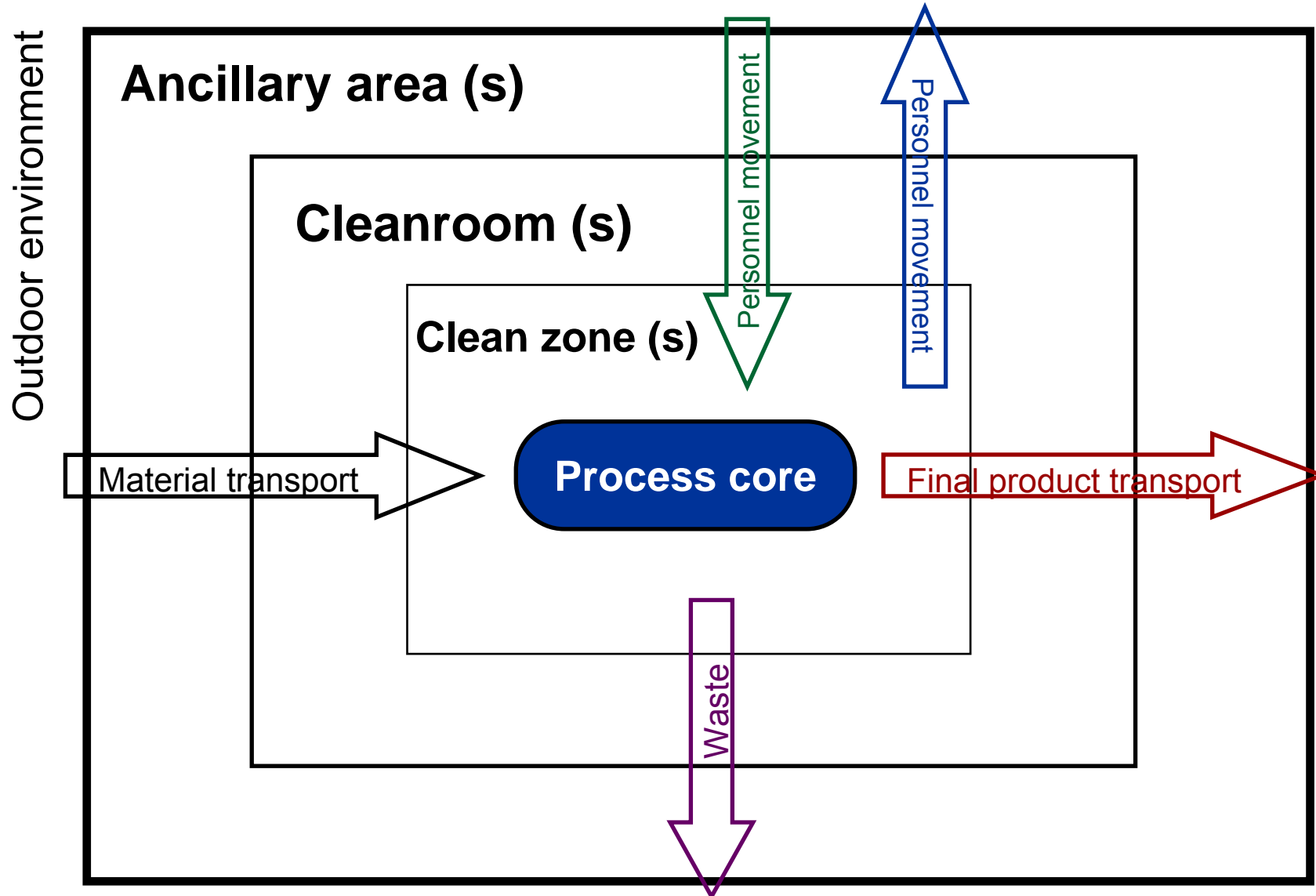

Control and segregation concepts ⁽³⁾

A.2 Airflow patterns

❖ Unidirectional airflow

- ✦ may be either vertical or horizontal
- ✦ ISO Class 5 and cleaner in operation

❖ Non-unidirectional airflow

- ✦ typical for cleanrooms of **ISO Class 6** and less clean in operation.

❖ Mixed-airflow cleanrooms combine both unidirectional and non-unidirectional airflow in the same room.

Note : Some special design are available that provide protection to specific working zones by other managed airflow techniques.

Control and segregation concepts (4)

A.3 Disturbance of unidirectional airflow

- ❖ In unidirectional airflow cleanrooms, **the design of physical obstacles** such as the process equipment, and the operating procedures, personnel movements and product handling, should consider basic aerodynamic requirements to prevent serious turbulence in the vicinity of the contamination-sensitive activity.
- ❖ Appropriate measures should be taken to avoid flow disturbances and cross-contamination between different work stations.

Influence of personnel and objects on unidirectional airflow (1)

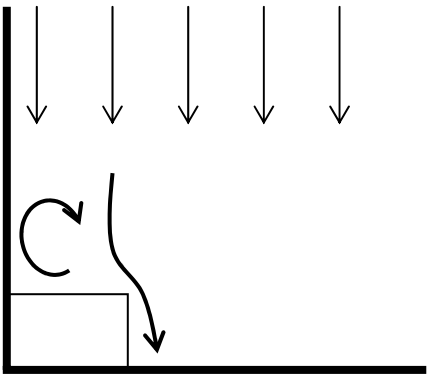
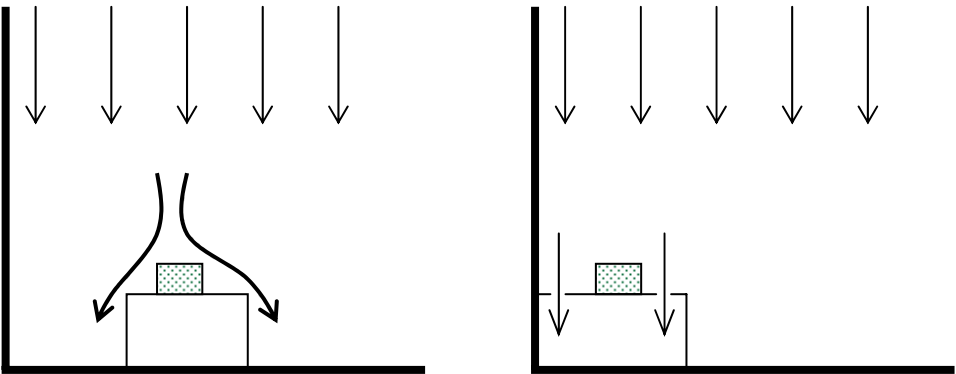
Flow obstacles causing a flow disturbance	Adjustments to equipment and behavior to improve airflow
	<p data-bbox="1019 790 1780 837">a) Improvement by arrangement</p> 

Influence of personnel and objects on unidirectional airflow (2)

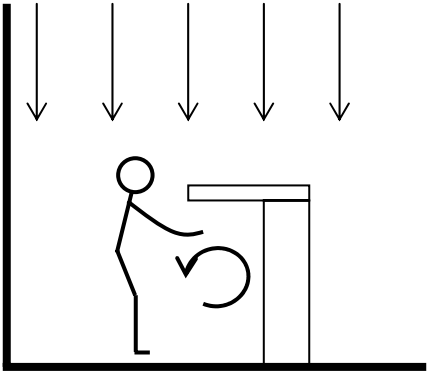
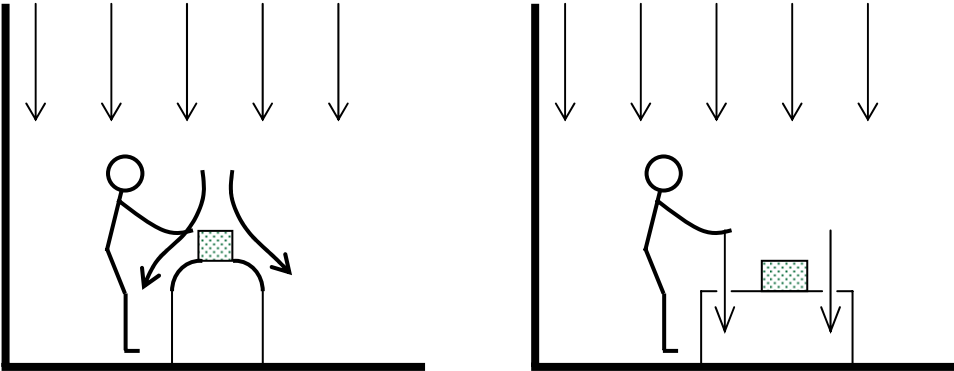
Flow obstacles causing a flow disturbance	Adjustments to equipment and behavior to improve airflow
	<p data-bbox="1048 788 1731 842">b) Improvement by structure</p> 

Influence of personnel and objects on unidirectional airflow (3)

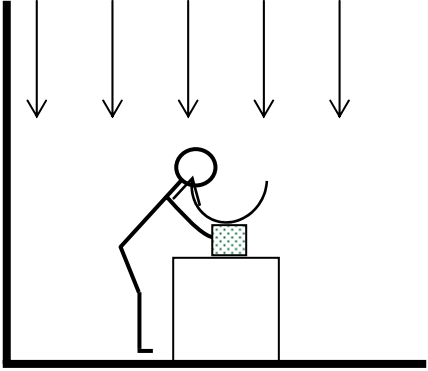
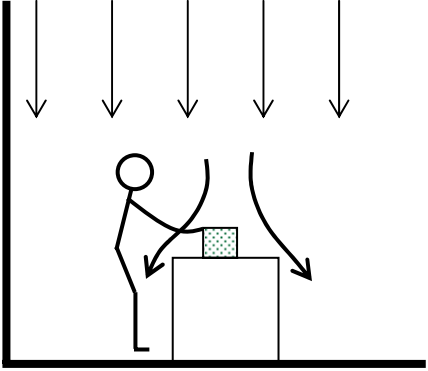
Flow obstacles causing a flow disturbance	Adjustments to equipment and behavior to improve airflow
 <p>The diagram shows a stick figure leaning over a table with a small box on it. Five vertical arrows point downwards from the top, representing the unidirectional airflow. The person's head and arms are positioned in the path of the airflow, causing a disturbance.</p>	<p data-bbox="913 775 1854 826">c) Improvement by personnel behaviour</p>  <p>The diagram shows a stick figure standing upright next to a table with a small box on it. Five vertical arrows point downwards from the top, representing the unidirectional airflow. The person is standing to the side of the table, allowing the airflow to pass unobstructed.</p>

Influence of personnel and objects on unidirectional airflow (4)

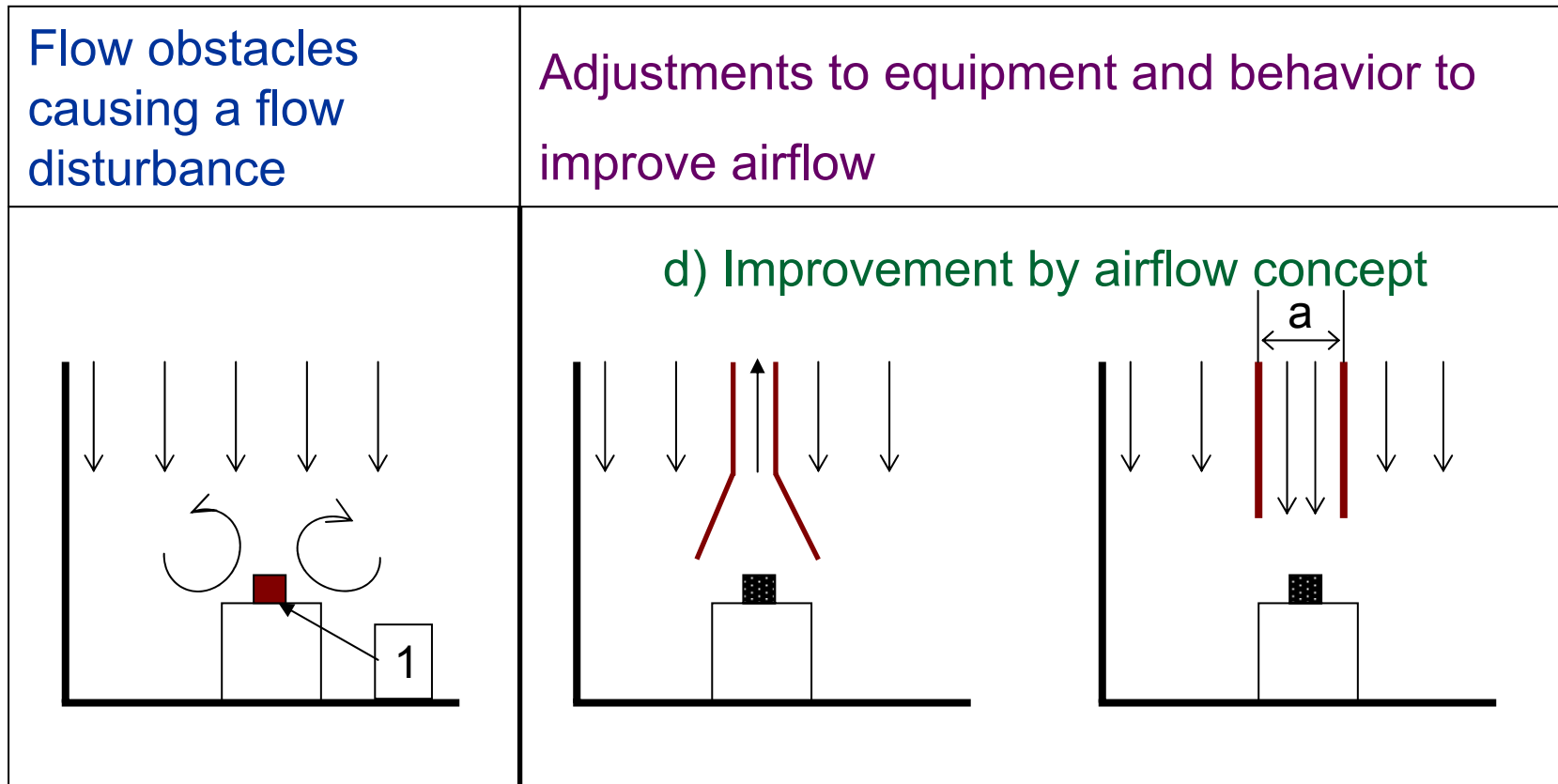

1 = Heat source

a = Local increase in air velocity

Control and segregation concepts ⁽⁹⁾

A.4 Contamination control concepts

- ❖ The transfer of contaminants into a zone protecting a process and/or personnel **can be prevented** by using
 - ✦ **aerodynamic measures**, i.e. by arrangement and flow direction
 - ✦ **physical barriers**, i.e. by both active and passive isolation, if any contact between product and operator/environment is to be prevented.
- ❖ If necessary, process exhaust should be treated to prevent contamination of outdoor environment.

Contamination control concepts using aerodynamic measures ⁽¹⁾

A) Product protection

Vertical flow

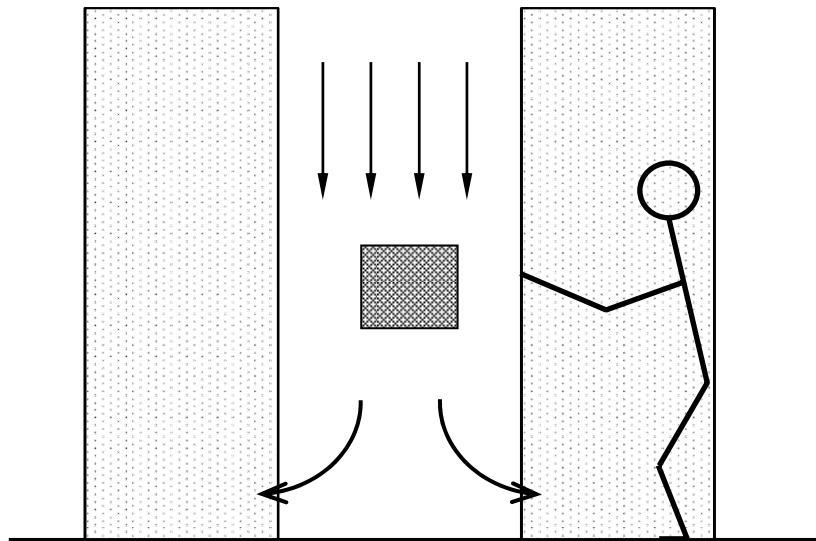

Horizontal flow

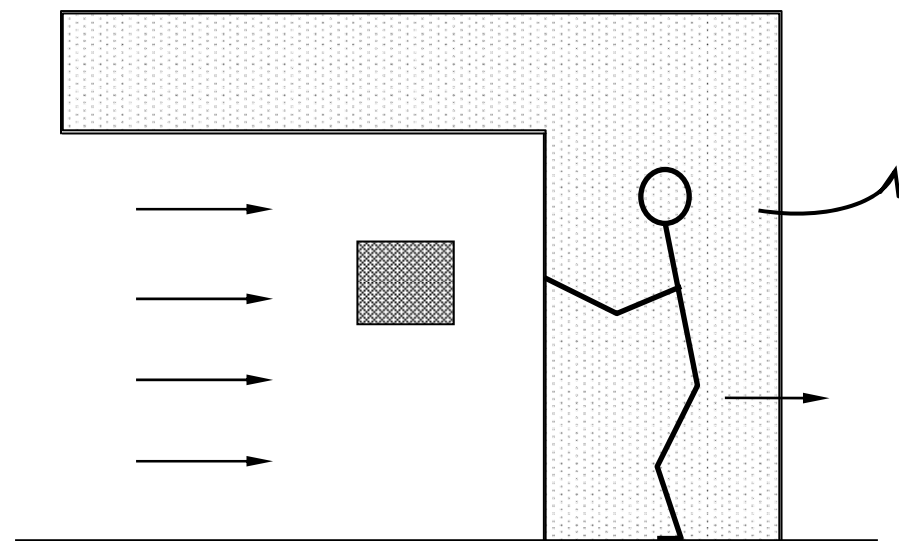

Contamination control concepts using aerodynamic measures ⁽²⁾

B) Personnel/Environmental protection

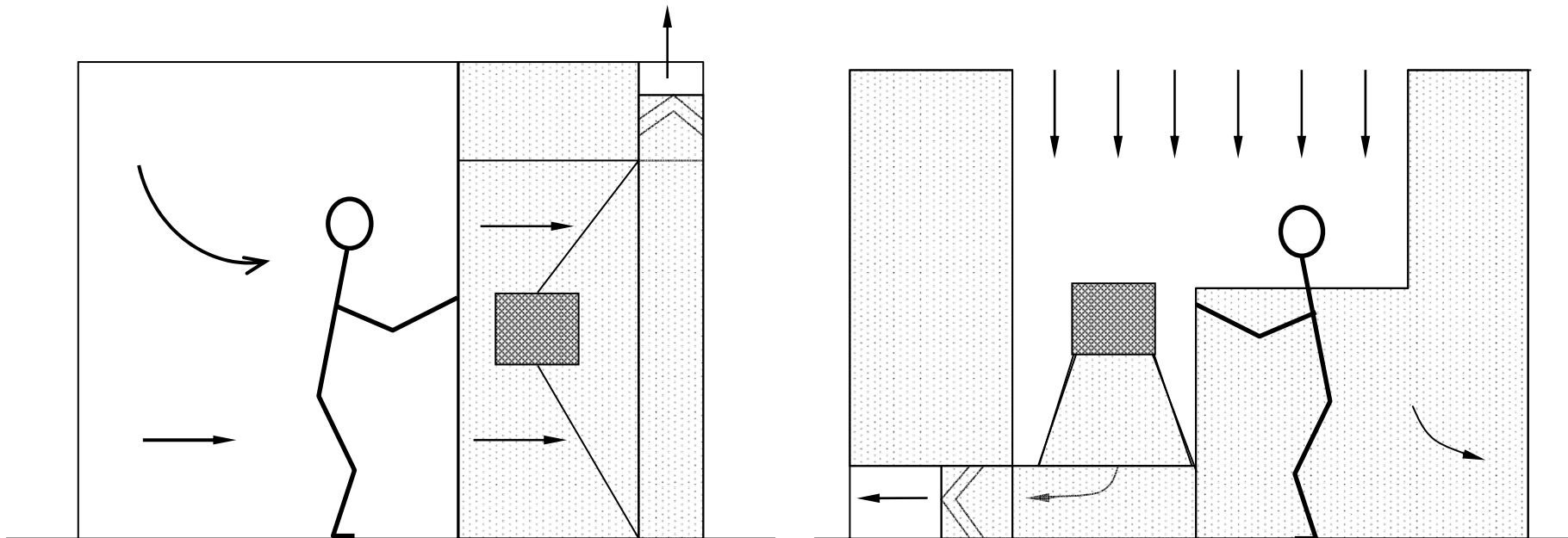

Contamination control concepts using aerodynamic measures ⁽³⁾

C) Personnel/Product/Environmental protection

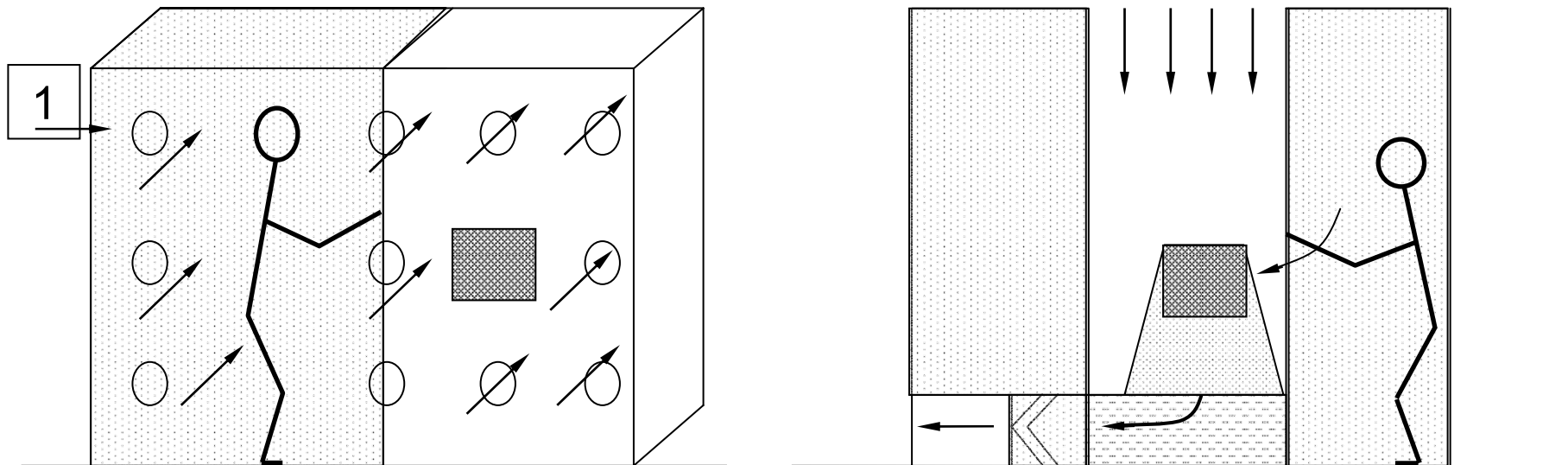

1 = Flow direction perpendicular to graphic plane

Contamination control concepts using physical segregation for product and personnel protection

Passive system

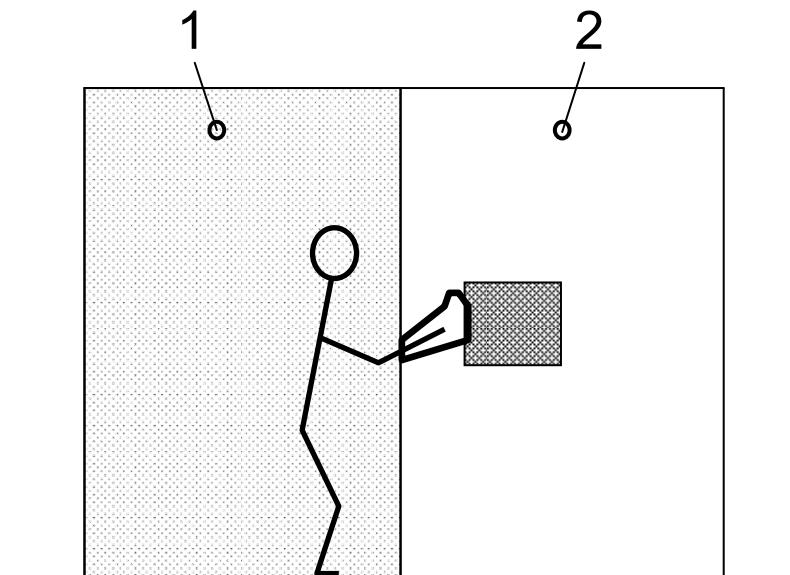

1 = Personnel safety zone

Airflow/Active system

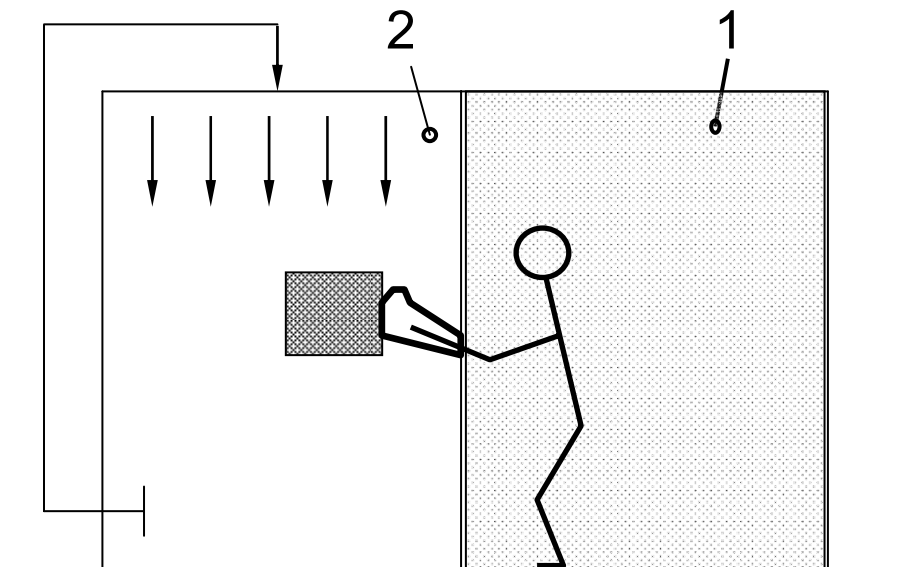

2 = Product protection zone

Control and segregation concepts ⁽¹⁴⁾

A.5 Concepts to achieve segregation of cleanrooms and clean zones

A.5.1 General

- ❖ In order to protect cleanrooms from contamination from adjacent less clean spaces, the cleanroom should be
 - ✦ maintained at a higher static pressure than the adjacent spaces,
 - ✦ or alternatively a controlling air velocity should be established across the leakage paths between the spaces flowing from the cleaner to the less clean spaces.
- ❖ Three basic concepts has been prepared to facilitate the selection of a suitable cleanroom or clean zone segregation concept.

Control and segregation concepts ⁽¹⁵⁾

A.5.2 Displacement concept (low pressure differential, high airflow)

- ❖ A low pressure differential can effectively separate clean and less clean adjacent zones, i.e. by means of low turbulent “displacement” airflow, e.g. **larger than 0.2 m/s**.
- ❖ Displacement airflow velocity should be typically above 0.2 m/s, from the cleaner zones towards the less clean zones.
- ❖ The necessary airflow velocity should be selected considering important conditions such as **physical obstacles**, heat sources, exhausts and contamination sources.

Displacement concept

(low pressure differential, high airflow)

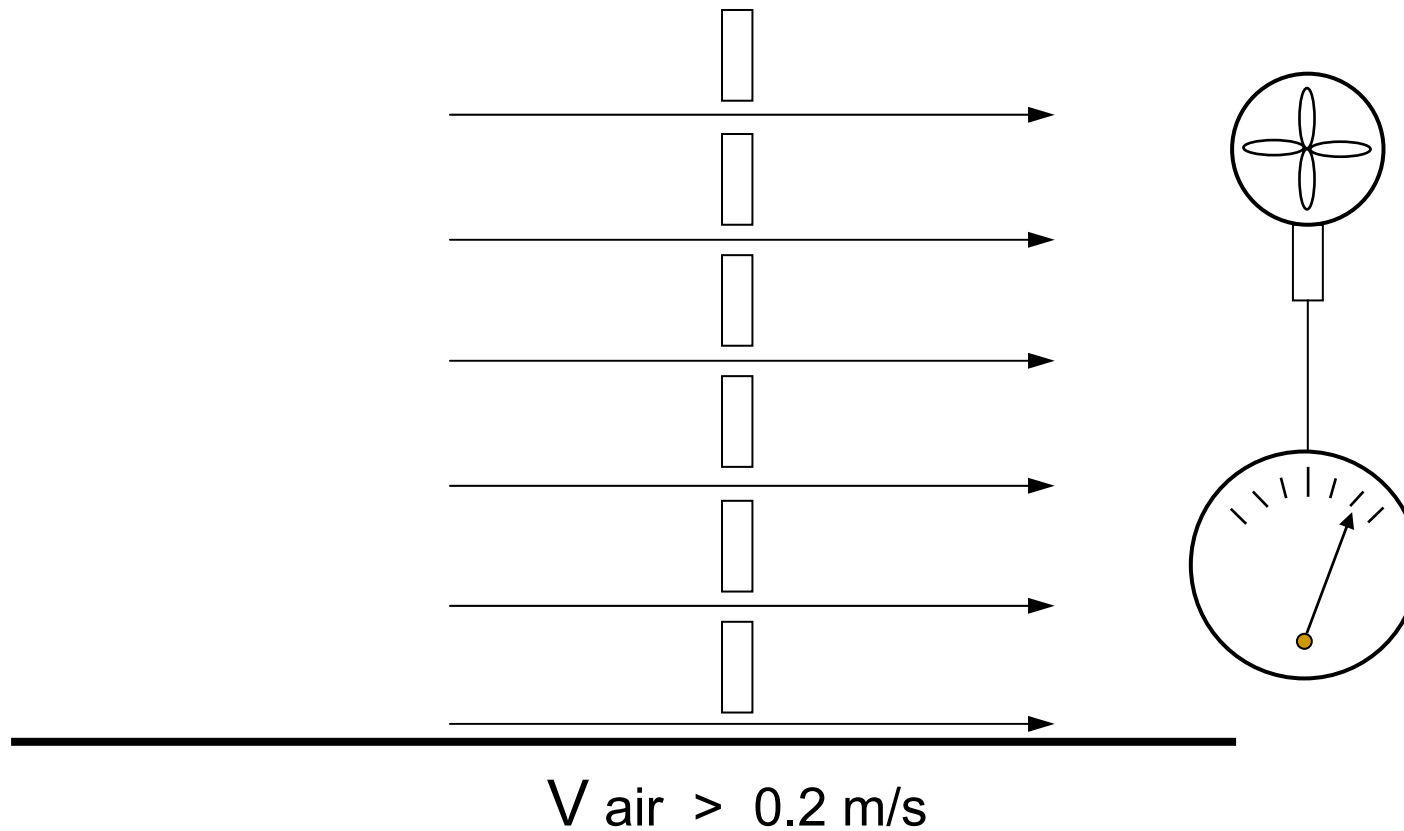

Control and segregation concepts (17)

A.5.3 Pressure differential concept (high pressure differential, low airflow)

- ❖ A pressure differential exists across the barrier between the **cleaner zone towards the less clean zone**. A high pressure differential between adjacent zone can be easily controlled but care is recommended to **avoid unacceptable turbulence**.
- ❖ The pressure differential **should be of sufficient magnitude and stable** prevent reversal of airflow direction from that intended.
- ❖ The pressure differential concept should be considered, whether **used alone or in combination** with other contamination control techniques and concepts.

Control and segregation concepts ⁽¹⁸⁾

A.5.3 Pressure differential concept (cont.)

- ❖ The pressure differential **between adjacent cleanrooms or clean zones of different cleanliness level** should lie typically in the range of **5 Pa to 20 Pa**, to allow doors to be opened and to avoid unintended cross-flows due to turbulence.
- ❖ The **static pressure** between cleanrooms of different class, and cleanrooms and unclassified areas can be **established and maintained using various airflow balancing techniques**. These include **both active/automated and passive/manual systems** that are configured to adjust the relative quantities of air that are delivered and removed from each space by **the ducted air system, air transfer system and losses**.

High pressure differential concept

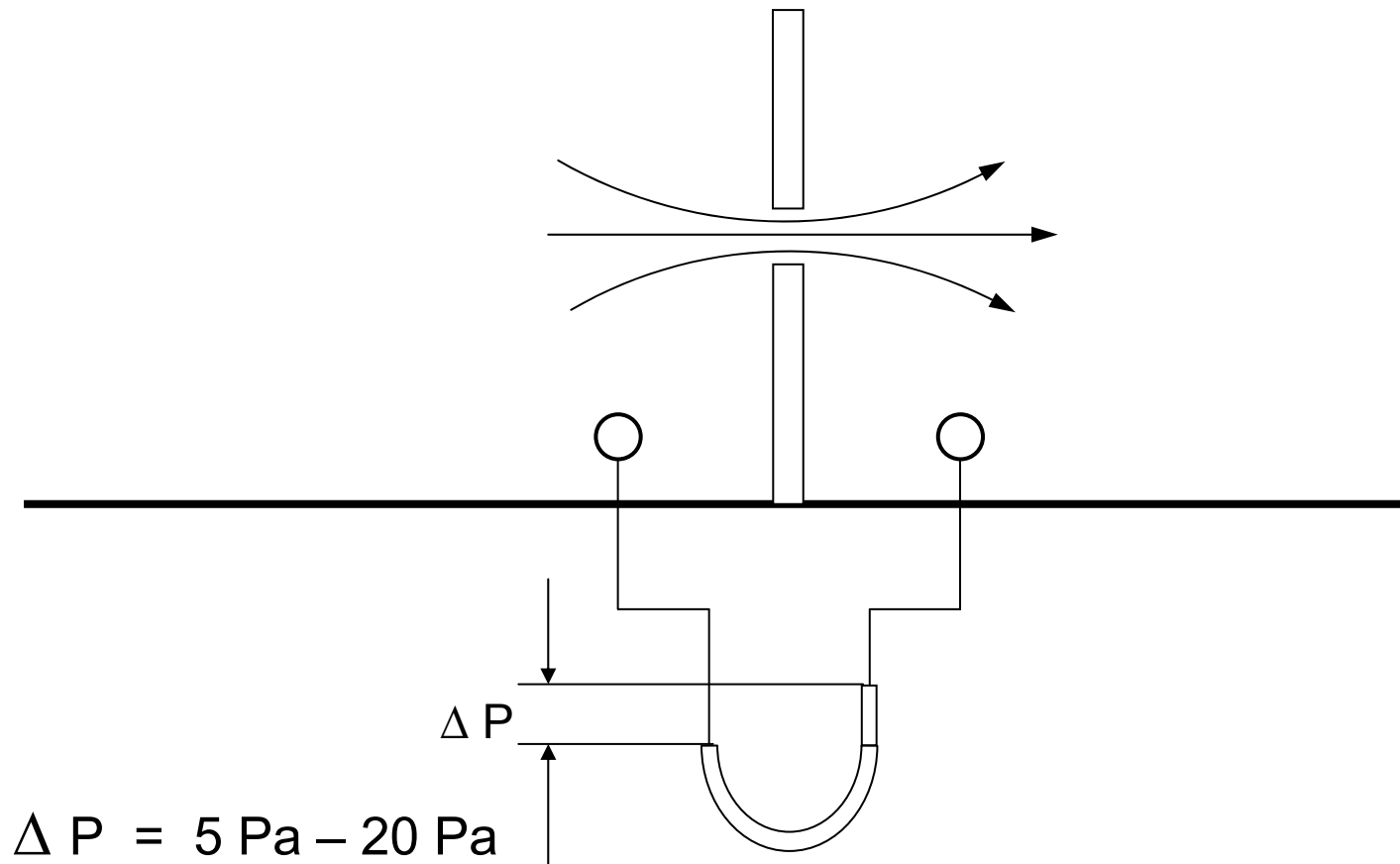

Control and segregation concepts (20)

A.5.3 Pressure differential concept (cont.)

- ❖ In situation when pressure differentials at the lower end of this range are accepted, special precautions should be taken to ensure accurate measurement of separating flow or pressure and to prove the stability of the installation.

Note : Flow visualization, either experimentally or by computation, can be used to demonstrate both the effectiveness of the displacement flow concept and pressure differential concept.

Control and segregation concepts ⁽²¹⁾

A.5.4 Physical barrier concept

- ❖ This concept involves the use of an impervious barrier to prevent contamination transfer to a clean zone from a less clean zone.

Note : All three concepts can be applied in the healthcare products, semiconductor, food and other industries.

Healthcare products

- ◆ **At the process core**, the sterile product is filled through an aseptic assembly of components in a clean zone, controlled for particulate and microbiological contamination.
- ◆ To access the process core, both the personnel and the process materials traverse **several shells of increasing cleanliness** (decreasing particulate concentrations).
- ◆ Personnel moving between various zones of different levels of cleanliness **may change garments between zone**, in accordance with the requirements of the zone that they are entering.
- ◆ Materials that enter each zone should be treated in a method appropriate to the level to be entered **to remove particulate and/or microbiological contamination**.

Cleanroom examples for aseptic processing of healthcare products

Air cleanliness class (ISO Class) in operation ^a	Airflow Type ^b	Average Airflow Velocity ^c m/s	Examples of Applications
5 (at $\geq 0.5 \mu\text{m}$)	U	> 0.2	processing ^d
7 (at $\geq 0.5\mu\text{m}$)	N or M	na	Other processing zones directly supporting aseptic processing
8 (at $\geq 0.5 \mu\text{m}$)	N or M	na	Support zones of aseptic processing including controlled preparation zone

NOTE 1 Application-specific classification requirements should take into account other relevant regulations.

NOTE 2 na = not applicable

a Occupancy states associated with the ISO Class should be defined and agreed in advance of establishing optimum design conditions.

b When airflow type is listed it represents the airflow characteristics for cleanrooms of that class : U = unidirectional; N = non-unidirectional; M= mixed (combination of U and N).

c Average airflow velocity is the way that unidirectional airflow in cleanrooms is usually specified. The requirement on unidirectional airflow velocity will depend on specific application such as temperature, and configuration of the controlled space and the items to be protected. Displacement airflow velocity should be typically above 0.2 m/s.

d Where operator protection is required to ensure safe handling of hazardous material, the use of segregation concepts (see examples in annex A) or appropriate safety cabinets and devices should be considered.

Layout of an installation ⁽¹⁾

- ◆ The size of a clean room should be kept to the minimum practicable, allowing for any future requirements. In general, if a large amount of space is required, it should be divided into **several zones or rooms, with or without physical barriers**.
- ◆ It is recognised that **the presence of people**, and activity, within the cleanroom can generate both contamination and disturbance of airflow.
- ◆ Within the cleanroom, critical work stations or areas of risk **should be sited away from entries and exits**, major traffic pathways and other features which may cause disruption of the airflow pattern and higher levels of contamination.

Layout of an installation ⁽²⁾

- ◆ Normally (non-emergency) access to or from the cleanroom should be **through airlocks** for both personnel and material.
- ◆ In order to **maintain pressure differential and integrity** of the controlled space during entry and exit, **airlocks or transfer hatches** (pass-thrus) will normally be required.
- ◆ Barrier benches or other clean demarcation systems, together with **appropriate decontamination devices and procedures**, should be employed **within an airlock system** for the passage of material.

Changing room ⁽¹⁾

- ◆ Changing rooms are special airlocks for the entry and exit of personnel to and from a cleanroom.
- ◆ They should include sufficient space for their function, and, depending on the cleanroom quality, facilities for donning and removing specialized garments, and may include **washing, disinfection facilities**, etc.. Special control devices such as **air showers and shoe cleaners** may be provided at the point (s) of **entry and exit** the cleanroom.

Changing room ⁽²⁾

- ◆ Separation of personnel entering from those leaving the cleanroom via the gowning room should be ensured. This can be achieved by **separation in time**, or by providing physically separate entry and exit routes.
- ◆ Where **hazardous materials** are processed, a **separate degowning and decontamination route** should be considered.

Changing room control and configuration ⁽¹⁾

To provide the requirement protection, consideration should be given to **three functional zones** of the changing room

- ◆ At the changing **room entry** : access from ancillary areas (either directly or via an airlock) appropriate for removal, storage, disposal and/or redonning of garments not permitted within the cleanroom;
- ◆ The **transition zone** : area where garments or personal equipment dedicated to the cleanroom are stored, donned or removed, as appropriate;
- ◆ **The inspection/access zone** : area where inspection of the completed gowning process is accomplished and which provides access to the cleanroom either directly or via an airlock

Changing room control and configuration ⁽²⁾

- ◆ The three functional zone may be separated by physical barrier (e.g. **stepover bench or airlock**) as appropriate to the operation and use of the changing room.
- ◆ The three zone should be established such that **the zone closest to the cleanroom provides a high degree of assurance**, and that there will be minimal adverse impact caused by access or gowning procedures implemented in the adjacent zone.

Facilities in changing rooms ⁽¹⁾

The following requirements should be defined :

- ◆ **Numbers** of people passing through the gowning procedure, both in absolute, and at any on time;
- ◆ The **gowning procedure** (i.e. what garments are to be taken off and put on, whether there are reusable or single-use , the required protocol to ensure garment cleanliness and to avoid cross-contamination.
- ◆ The **frequency** of garment replacement.

Facilities in changing rooms (2)

Consideration should be given to the following provisions in the changing room :

- ◆ Storage and disposal of garment;
- ◆ Storage before use, provision and disposal of consumable items and accessories (e.g. gloves, masks, protective glasses, overshoes);
- ◆ Storage of personal items;
- ◆ **Hand washing and drying** or other decontamination processes;
- ◆ Prominent display or posting of gowning sequence, with clear instructions;
- ◆ **Full length mirrors** to check effective fit.

Reference

1. Cleanrooms and associated controlled environments Part 1 : Classification of air cleanliness, ISO 14644-1 : 1999
2. Cleanrooms and associated controlled environments Part 2 : Specifications for testing and monitoring to prove continued compliance with ISO 14644-1, ISO 14644-2 : 2000
3. Cleanrooms and associated controlled environments Part 3 : Test methods, ISO 14644-3 : 2005
4. Cleanrooms and associated controlled environments Part 4 : design, construction and start-up, ISO 14644-4 : 2001
5. Guide to Good Manufacturing Practice for Medical Products. Pharmaceutical Inspection Convention/ Pharmaceutical Inspection Co-operation Scheme, PE 009-2, 1 July 2004.
6. Good manufacturing practices for sterile pharmaceutical products. In : WHO Expert Committee on Specification for Pharmaceutical Preparations. Thirty-sixth report. Geneva, World Health Organization, 2002, Annex 6 (WHO Technical Report Series, No. 902).
7. Sterile Drug Products Produced by Aseptic Processing - Current Good Manufacturing Practice, Guidance for Industry, U.S. Department of Health and Human Services, September 2004.