

See discussions, stats, and author profiles for this publication at: <https://www.researchgate.net/publication/318672647>

introduction to hydraulic systems

Chapter · July 2017

CITATIONS

2

READS

137,521

1 author:



Osama Mohammed Elmardi Suleiman Khayal
Nile Valley University

2,051 PUBLICATIONS 2,930 CITATIONS

SEE PROFILE

Some of the authors of this publication are also working on these related projects:



Stability of Structures [View project](#)



mechanics of materials [View project](#)

Module 5: Hydraulic Systems

Lecture 1

Introduction

1. Introduction

The controlled movement of parts or a controlled application of force is a common requirement in the industries. These operations are performed mainly by using electrical machines or diesel, petrol and steam engines as a prime mover. These prime movers can provide various movements to the objects by using some mechanical attachments like screw jack, lever, rack and pinions etc. However, these are not the only prime movers. The enclosed fluids (liquids and gases) can also be used as prime movers to provide controlled motion and force to the objects or substances. The specially designed enclosed fluid systems can provide both linear as well as rotary motion. The high magnitude controlled force can also be applied by using these systems. This kind of enclosed fluid based systems using pressurized incompressible liquids as transmission media are called as hydraulic systems. The hydraulic system works on the principle of Pascal's law which says that the pressure in an enclosed fluid is uniform in all the directions. The Pascal's law is illustrated in figure 5.1.1. The force given by fluid is given by the multiplication of pressure and area of cross section. As the pressure is same in all the direction, the smaller piston feels a smaller force and a large piston feels a large force. Therefore, a large force can be generated with smaller force input by using hydraulic systems.

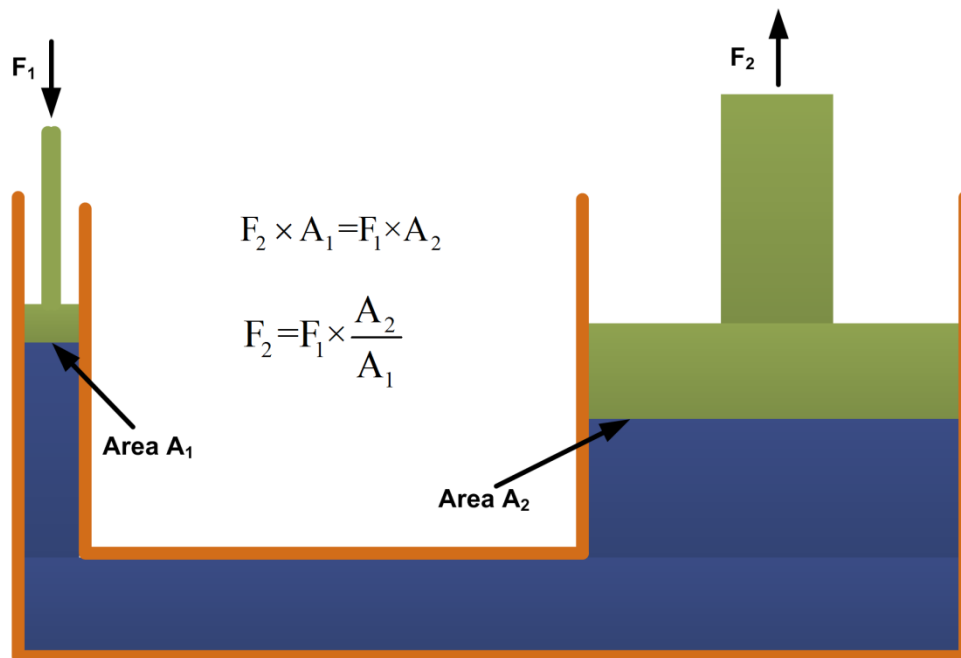


Figure 5.1.1 Principle of hydraulic system

The hydraulic systems consists a number of parts for its proper functioning. These include storage tank, filter, hydraulic pump, pressure regulator, control valve, hydraulic cylinder, piston and leak proof fluid flow pipelines. The schematic of a simple hydraulic system is shown in figure 5.1.2. It consists of:

- a movable piston connected to the output shaft in an enclosed cylinder
- storage tank
- filter
- electric pump
- pressure regulator
- control valve
- leak proof closed loop piping.

The output shaft transfers the motion or force however all other parts help to control the system. The storage/fluid tank is a reservoir for the liquid used as a transmission media. The liquid used is generally high density incompressible oil. It is filtered to remove dust or any other unwanted particles and then pumped by the hydraulic pump. The capacity of pump depends on the hydraulic system design. These pumps generally deliver constant volume in each revolution of the pump shaft. Therefore, the fluid pressure can increase indefinitely at the dead end of the piston until the system fails. The pressure regulator is used to avoid such circumstances which redirect the excess fluid back to the storage tank. The movement of piston is controlled by changing liquid flow from port A and port B. The cylinder movement is controlled by using control valve which directs the fluid flow. The fluid pressure line is connected to the port B to raise the piston and it is connected to port A to lower down the piston. The valve can also stop the fluid flow in any of the port. The leak proof piping is also important due to safety, environmental hazards and economical aspects. Some accessories such as flow control system, travel limit control, electric motor starter and overload protection may also be used in the hydraulic systems which are not shown in figure 5.1.2.

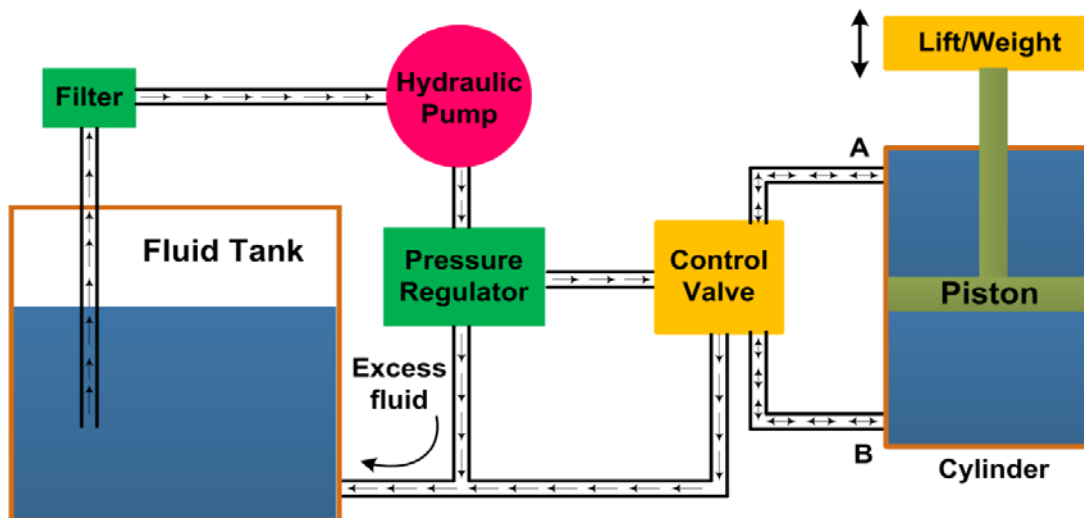


Figure 5.1.2 Schematic of hydraulic system

2. Applications of hydraulic systems

The hydraulic systems are mainly used for precise control of larger forces. The main applications of hydraulic system can be classified in five categories:

- 2.1 Industrial:** Plastic processing machineries, steel making and primary metal extraction applications, automated production lines, machine tool industries, paper industries, loaders, crushes, textile machineries, R & D equipment and robotic systems etc.
- 2.2 Mobile hydraulics:** Tractors, irrigation system, earthmoving equipment, material handling equipment, commercial vehicles, tunnel boring equipment, rail equipment, building and construction machineries and drilling rigs etc.
- 2.3 Automobiles:** It is used in the systems like breaks, shock absorbers, steering system, wind shield, lift and cleaning etc.
- 2.4 Marine applications:** It mostly covers ocean going vessels, fishing boats and navel equipment.
- 2.5 Aerospace equipment:** There are equipment and systems used for rudder control, landing gear, breaks, flight control and transmission etc. which are used in airplanes, rockets and spaceships.

3. Hydraulic Pump

The combined pumping and driving motor unit is known as hydraulic pump. The hydraulic pump takes hydraulic fluid (mostly some oil) from the storage tank and delivers it to the rest of the hydraulic circuit. In general, the speed of pump is constant and the pump delivers an equal volume of oil in each revolution. The amount and direction of fluid flow is controlled by some external mechanisms. In some cases, the hydraulic pump itself is operated by a servo controlled motor but it makes the system complex. The hydraulic pumps are characterized by its flow rate capacity, power consumption, drive speed, pressure delivered at the outlet and efficiency of the pump. The pumps are not 100% efficient. The efficiency of a pump can be specified by two ways. One is the volumetric efficiency which is the ratio of actual volume of fluid delivered to the maximum theoretical volume possible. Second is power efficiency which is the ratio of output hydraulic power to the input mechanical/electrical power. The typical efficiency of pumps varies from 90-98%.

The hydraulic pumps can be of two types:

- centrifugal pump
- reciprocating pump

Centrifugal pump uses rotational kinetic energy to deliver the fluid. The rotational energy typically comes from an engine or electric motor. The fluid enters the pump impeller along or near to the rotating axis, accelerates in the propeller and flung out to the periphery by centrifugal force as shown in figure 5.1.3. In centrifugal pump the delivery is not constant and varies according to the outlet pressure. These pumps are not suitable for high pressure applications and are generally used for low-pressure and high-volume flow applications. The maximum pressure capacity is limited to 20-30 bars and the specific speed ranges from 500 to 10000. Most of the centrifugal pumps are not self-priming and the pump casing needs to be filled with liquid before the pump is started.

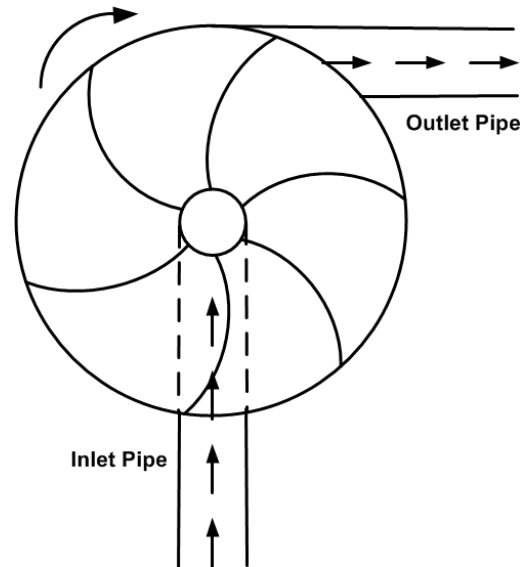


Figure 5.1.3 Centrifugal pump

The reciprocating pump is a positive plunger pump. It is also known as positive displacement pump or piston pump. It is often used where relatively small quantity is to be handled and the delivery pressure is quite large. The construction of these pumps is similar to the four stroke engine as shown in figure 5.1.4. The crank is driven by some external rotating motor. The piston of pump reciprocates due to crank rotation. The piston moves down in one half of crank rotation, the inlet valve opens and fluid enters into the cylinder. In second half crank rotation the piston moves up, the outlet valve opens and the fluid moves out from the outlet. At a time, only one valve is opened and another is closed so there is no fluid leakage. Depending on the area of cylinder the pump delivers constant volume of fluid in each cycle independent to the pressure at the output port.

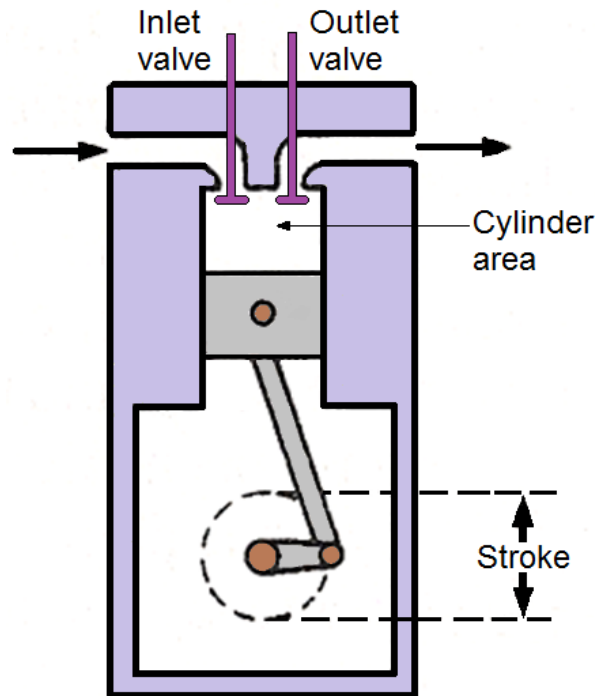


Figure 5.1.4 Reciprocating or positive displacement pump

4. Pump Lift

In general, the pump is placed over the fluid storage tank as shown in figure 5.1.5. The pump creates a negative pressure at the inlet which causes fluid to be pushed up in the inlet pipe by atmospheric pressure. It results in the fluid lift in the pump suction. The maximum pump lift can be determined by atmospheric pressure and is given by pressure head as given below:

$$\text{Pressure Head, } P = \rho gh \quad (5.1.1)$$

Theoretically, a pump lift of 8 m is possible but it is always lesser due to undesirable effects such as cavitation. The cavitation is the formation of vapor cavities in a liquid. The cavities can be small liquid-free zones ("bubbles" or "voids") formed due to partial vaporization of fluid (liquid). These are usually generated when a liquid is subjected to rapid changes of pressure and the pressure is relatively low. At higher pressure, the voids implode and can generate an intense shockwave. Therefore, the cavitation should always be avoided. The cavitation can be reduced by maintaining lower flow velocity at the inlet and therefore the inlet pipes have larger diameter than the outlet pipes in a pump. The pump lift should be as small as possible to decrease the cavitation and to increase the efficiency of the pump.

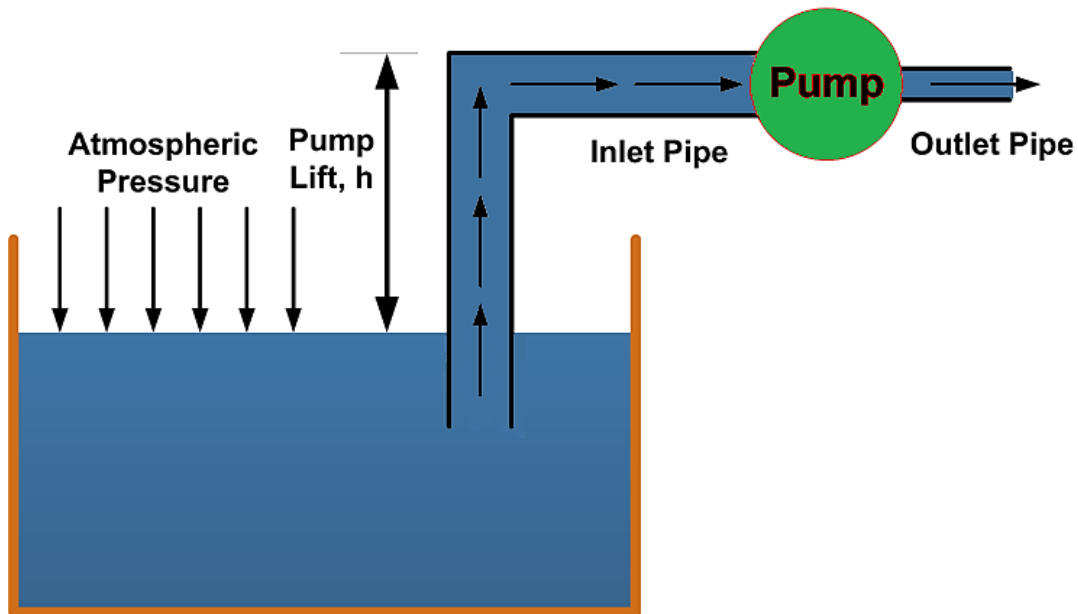


Figure 5.1.5 Pump lift

5. Pressure Regulation

The pressure regulation is the process of reduction of high source pressure to a lower working pressure suitable for the application. It is an attempt to maintain the outlet pressure within acceptable limits. The pressure regulation is performed by using pressure regulator. The primary function of a pressure regulator is to match the fluid flow with demand. At the same time, the regulator must maintain the outlet pressure within certain acceptable limits.

The schematic of pressure regulator and various valves placement is shown in figure 5.1.6. When the valve V_1 is closed and V_2 is opened then the load moves down and fluid returns to the tank but the pump is dead ended and it leads to a continuous increase in pressure at pump delivery. Finally, it may lead to permanent failure of the pump. Therefore some method is needed to keep the delivery pressure P_1 within the safe level. It can be achieved by placing pressure regulating valve V_3 as shown in figure 5.1.6. This valve is closed in normal conditions and when the pressure exceeds a certain limit, it opens and fluid from pump outlet returns to the tank via pressure regulating valve V_3 . As the pressure falls in a limiting range, the valve V_3 closes again.

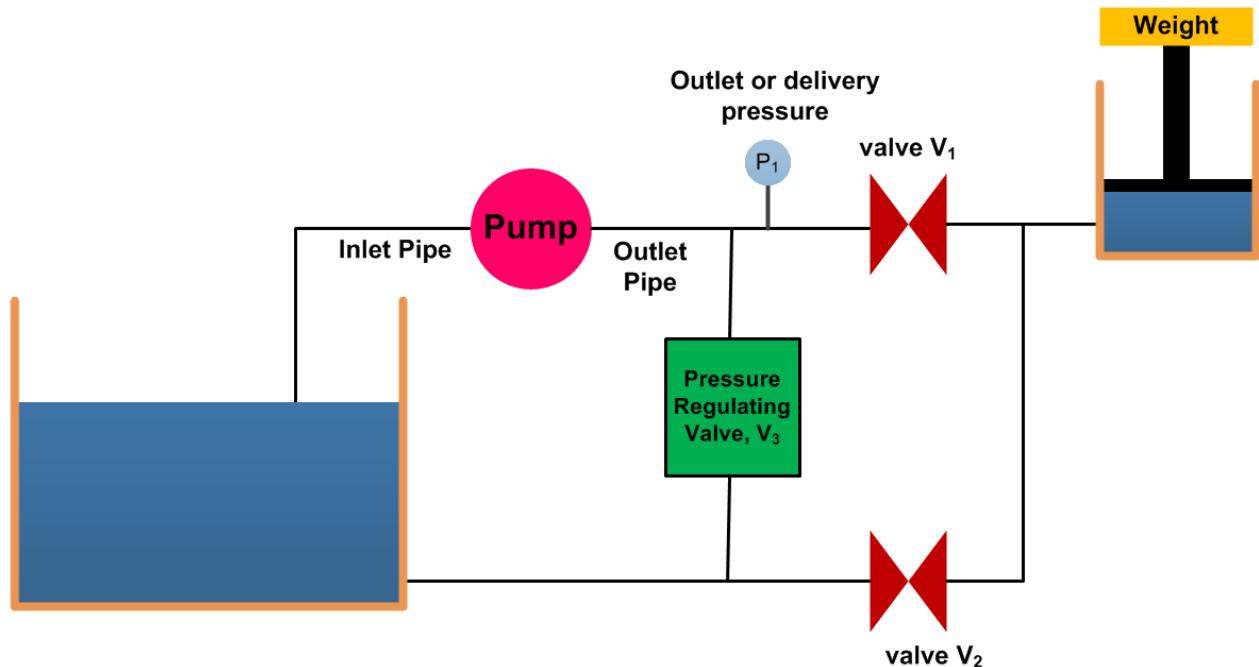


Figure 5.1.6 Schematic of pressure regulation

When valve V_1 is closed, the whole fluid is dumped back to the tank through the pressure regulating valve. This leads to the substantial loss of power because the fluid is circulating from tank to pump and then pump to tank without performing any useful work. This may lead to increase in fluid temperature because the energy input into fluid leads to the increase in fluid temperature. This may need to the installation of heat exchanger in to the storage tank to extract the excess heat. Interestingly, the motor power

consumption is more in such condition because the outlet pressure is higher than the working pressure.

6. Advantages and Disadvantages of Hydraulic system

6.1 Advantages

- The hydraulic system uses incompressible fluid which results in higher efficiency.
- It delivers consistent power output which is difficult in pneumatic or mechanical drive systems.
- Hydraulic systems employ high density incompressible fluid. Possibility of leakage is less in hydraulic system as compared to that in pneumatic system. The maintenance cost is less.
- These systems perform well in hot environment conditions.

6.2 Disadvantages

- The material of storage tank, piping, cylinder and piston can be corroded with the hydraulic fluid. Therefore one must be careful while selecting materials and hydraulic fluid.
- The structural weight and size of the system is more which makes it unsuitable for the smaller instruments.
- The small impurities in the hydraulic fluid can permanently damage the complete system, therefore one should be careful and suitable filter must be installed.
- The leakage of hydraulic fluid is also a critical issue and suitable prevention method and seals must be adopted.
- The hydraulic fluids, if not disposed properly, can be harmful to the environment.

Module 5: Hydraulic Systems

Lecture 2

Hydraulic Pumps

1. Classification of Hydraulic Pumps

These are mainly classified into two categories:

- A. Non-positive displacement pumps
- B. Positive displacement pumps.

A. Non-Positive Displacement Pumps

These pumps are also known as hydro-dynamic pumps. In these pumps the fluid is pressurized by the rotation of the propeller and the fluid pressure is proportional to the rotor speed. These pumps can not withstanding high pressures and generally used for low-pressure and high-volume flow applications. The fluid pressure and flow generated due to inertia effect of the fluid. The fluid motion is generated due to rotating propeller. These pumps provide a smooth and continuous flow but the flow output decreases with increase in system resistance (load). The flow output decreases because some of the fluid slip back at higher resistance. The fluid flow is completely stopped at very large system resistance and thus the volumetric efficiency will become zero. Therefore, the flow rate not only depends on the rotational speed but also on the resistance provided by the system. The important advantages of non-positive displacement pumps are lower initial cost, less operating maintenance because of less moving parts, simplicity of operation, higher reliability and suitability with wide range of fluid etc. These pumps are primarily used for transporting fluids and find little use in the hydraulic or fluid power industries. Centrifugal pump is the common example of non-positive displacement pumps. Details have already discussed in the previous lecture.

B. Positive displacement pump

These pumps deliver a constant volume of fluid in a cycle. The discharge quantity per revolution is fixed in these pumps and they produce fluid flow proportional to their displacement and rotor speed. These pumps are used in most of the industrial fluid power applications. The output fluid flow is constant and is independent of the system pressure (load). The important advantage associated with these pumps is that the high-pressure and low-pressure areas (means input and output region) are separated and hence the fluid cannot leak back due to higher pressure at the outlets. These features make the positive displacement pump most suited and universally accepted for hydraulic systems. The important advantages of positive displacement pumps over non-positive displacement pumps include capability to generate high pressures, high volumetric efficiency, high

power to weight ratio, change in efficiency throughout the pressure range is small and wider operating range pressure and speed. The fluid flow rate of these pumps ranges from 0.1 and 15,000 gpm, the pressure head ranges between 10 and 100,000 psi and specific speed is less than 500.

It is important to note that the positive displacement pumps do not produce pressure but they only produce fluid flow. The resistance to output fluid flow generates the pressure. It means that if the discharge port (output) of a positive displacement pump is opened to the atmosphere, then fluid flow will not generate any output pressure above atmospheric pressure. But, if the discharge port is partially blocked, then the pressure will rise due to the increase in fluid flow resistance. If the discharge port of the pump is completely blocked, then an infinite resistance will be generated. This will result in the breakage of the weakest component in the circuit. Therefore, the safety valves are provided in the hydraulic circuits along with positive displacement pumps. Important positive displacement pumps are gears pumps, vane pumps and piston pumps. The details of these pumps are discussed in the following sections.

2. Gear Pumps

Gear pump is a robust and simple positive displacement pump. It has two meshed gears revolving about their respective axes. These gears are the only moving parts in the pump. They are compact, relatively inexpensive and have few moving parts. The rigid design of the gears and houses allow for very high pressures and the ability to pump highly viscous fluids. They are suitable for a wide range of fluids and offer self-priming performance. Sometimes gear pumps are designed to function as either a motor or a pump. These pump includes helical and herringbone gear sets (instead of spur gears), lobe shaped rotors similar to Roots blowers (commonly used as superchargers), and mechanical designs that allow the stacking of pumps. Based upon the design, the gear pumps are classified as:

- External gear pumps
- Lobe pumps
- Internal gear pumps
- Gerotor pumps

Generally gear pumps are used to pump:

- Petrochemicals: Pure or filled bitumen, pitch, diesel oil, crude oil, lube oil etc.
- Chemicals: Sodium silicate, acids, plastics, mixed chemicals, isocyanates etc.
- Paint and ink
- Resins and adhesives
- Pulp and paper: acid, soap, lye, black liquor, kaolin, lime, latex, sludge etc.
- Food: Chocolate, cacao butter, fillers, sugar, vegetable fats and oils, molasses, animal food etc.

2.1 External gear pump

The external gear pump consists of externally meshed two gears housed in a pump case as shown in figure 5.2.1. One of the gears is coupled with a prime mover and is called as driving gear and another is called as driven gear. The rotating gear carries the fluid from the tank to the outlet pipe. The suction side is towards the portion where the gear teeth come out of the mesh. When the gears rotate, volume of the chamber expands leading to pressure drop below atmospheric value. Therefore the vacuum is created and the fluid is pushed into the void due to atmospheric pressure. The fluid is trapped between housing and rotating teeth of the gears. The discharge side of pump is towards the portion where the gear teeth run into the mesh and the volume decreases between meshing teeth. The pump has a positive internal seal against leakage; therefore, the fluid is forced into the outlet port. The gear pumps are often equipped with the side wear plate to avoid the leakage. The clearance between gear teeth and housing and between side plate and gear face is very important and plays an important role in preventing leakage. In general, the gap distance is less than 10 micrometers. The amount of fluid discharge is determined by the number of gear teeth, the volume of fluid between each pair of teeth and the speed of rotation. The important drawback of external gear pump is the unbalanced side load on its bearings. It is caused due to high pressure at the outlet and low pressure at the inlet which results in slower speeds and lower pressure ratings in addition to reducing the bearing life. Gear pumps are most commonly used for the hydraulic fluid power applications and are widely used in chemical installations to pump fluid with a certain viscosity.

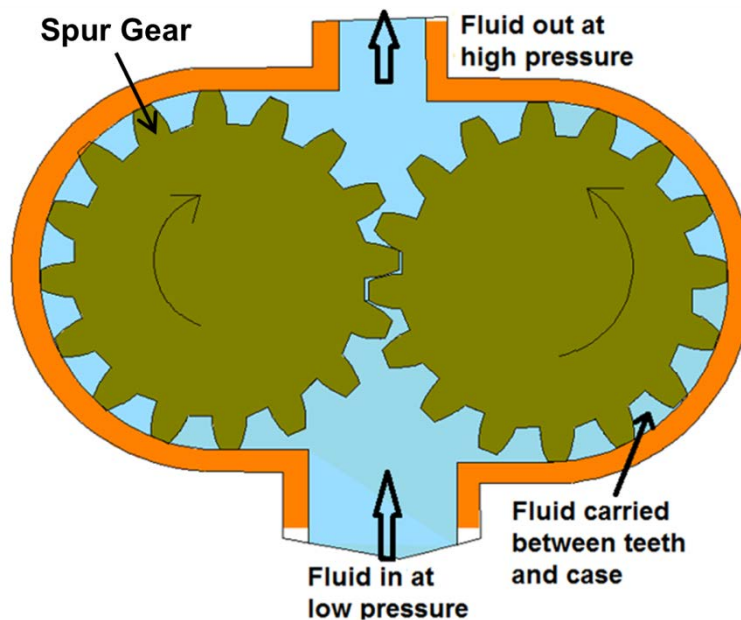


Figure 5.2.1 Gear pump

2.2 Lobe Pump

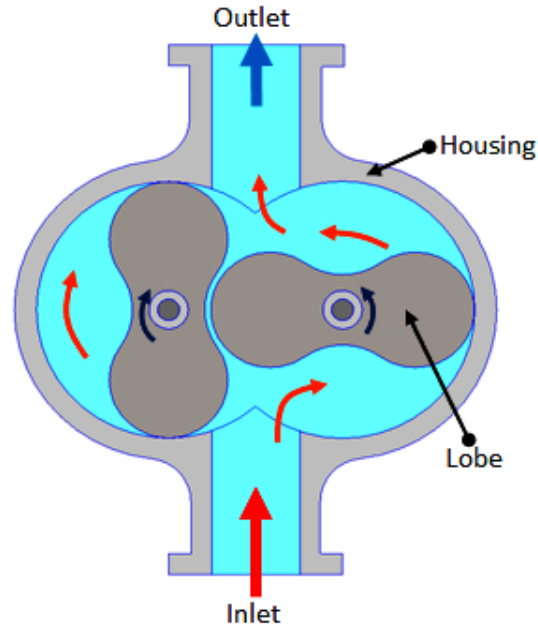


Figure 5.2.3 Lobe pump

Lobe pumps work on the similar principle of working as that of external gear pumps. However in Lobe pumps, the lobes do not make any contact like external gear pump (see Figure 5.2.3). Lobe contact is prevented by external timing gears located in the gearbox. Similar to the external gear pump, the lobes rotate to create expanding volume at the inlet. Now, the fluid flows into the cavity and is trapped by the lobes. Fluid travels around the interior of casing in the pockets between the lobes and the casing. Finally, the meshing of the lobes forces liquid to pass through the outlet port. The bearings are placed out of the pumped liquid. Therefore the pressure is limited by the bearing location and shaft deflection.

Because of superb sanitary qualities, high efficiency, reliability, corrosion resistance and good clean-in-place and steam-in-place (CIP/SIP) characteristics, Lobe pumps are widely used in industries such as pulp and paper, chemical, food, beverage, pharmaceutical and biotechnology etc. These pumps can handle solids (e.g., cherries and olives), slurries, pastes, and a variety of liquids. A gentle pumping action minimizes product degradation. They also offer continuous and intermittent reversible flows. Flow is relatively independent of changes in process pressure and therefore, the output is constant and continuous.

Lobe pumps are frequently used in food applications because they handle solids without damaging the product. Large sized particles can be pumped much effectively than in other positive displacement types. As the lobes do not make any direct contact therefore, the clearance is not as close as in other Positive displacement pumps. This specific design of pump makes it suitable to handle low viscosity fluids with diminished performance.

Loading characteristics are not as good as other designs, and suction ability is low. High-viscosity liquids require reduced speeds to achieve satisfactory performance. The reduction in speed can be 25% or more in case of high viscosity fluid.

2.3 Internal Gear Pump

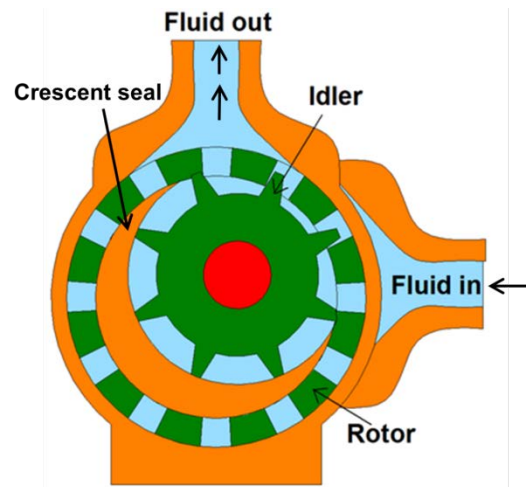


Figure 5.2.4 Internal gear pump

Internal gear pumps are exceptionally versatile. They are often used for low or medium viscosity fluids such as solvents and fuel oil and wide range of temperature. This is non-pulsing, self-priming and can run dry for short periods. It is a variation of the basic gear pump.

It comprises of an internal gear, a regular spur gear, a crescent-shaped seal and an external housing. The schematic of internal gear pump is shown in figure 5.2.4. Liquid enters the suction port between the rotor (large exterior gear) and idler (small interior gear) teeth. Liquid travels through the pump between the teeth and crescent. Crescent divides the liquid and acts as a seal between the suction and discharge ports. When the teeth mesh on the side opposite to the crescent seal, the fluid is forced out through the discharge port of the pump. This clearance between gears can be adjusted to accommodate high temperature, to handle high viscosity fluids and to accommodate the wear. These pumps are bi-rotational so that they can be used to load and unload the vessels. As these pumps have only two moving parts and one stuffing box, therefore they are reliable, simple to operate and easy to maintain. However, these pumps are not suitable for high speed and high pressure applications. Only one bearing is used in the pump therefore overhung load on shaft bearing reduces the life of the bearing.

Applications

Some common internal gear pump applications are:

- All varieties of fuel oil and lube oil
- Resins and Polymers
- Alcohols and solvents
- Asphalt, Bitumen, and Tar
- Polyurethane foam (Isocyanate and polyol)
- Food products such as corn syrup, chocolate, and peanut butter
- Paint, inks, and pigments
- Soaps and surfactants
- Glycol

2.4 Gerotor Pump

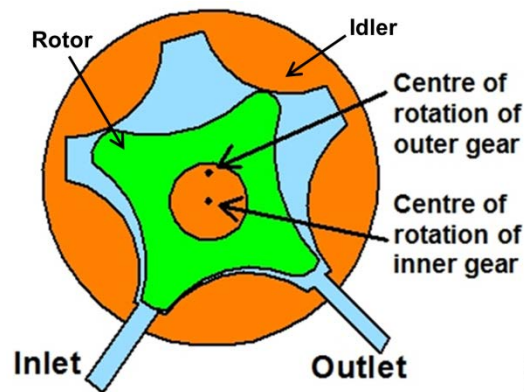


Figure 5.2.5 Gerotor pump

Gerotor is a positive displacement pump. The name Gerotor is derived from "Generated Rotor". At the most basic level, a Gerotor is essentially one that is moved via fluid power. Originally this fluid was water, today the wider use is in hydraulic devices. The schematic of Gerotor pump is shown in figure 5.2.5. Gerotor pump is an internal gear pump without the crescent. It consists of two rotors viz. inner and outer rotor. The inner rotor has N teeth, and the outer rotor has $N+1$ teeth. The inner rotor is located off-center and both rotors rotate. The geometry of the two rotors partitions the volume between them into N different dynamically-changing volumes. During the rotation, volume of each partition changes continuously. Therefore, any given volume first increases, and then decreases. An increase in volume creates vacuum. This vacuum creates suction, and thus, this part of the cycle sucks the fluid. As the volume decreases, compression occurs. During this compression period, fluids can be pumped, or compressed (if they are gaseous fluids).

The close tolerance between the gears acts as a seal between the suction and discharge ports. Rotor and idler teeth mesh completely to form a seal equidistant from the discharge and suction ports. This seal forces the liquid out of the discharge port. The flow output is uniform and constant at the outlets.

The important advantages of the pumps are high speed operation, constant discharge in all pressure conditions, bidirectional operation, less sound in running condition and less maintenance due to only two moving parts and one stuffing box etc. However, the pump is having some limitations such as medium pressure operating range, clearance is fixed, solids can't be pumped and overhung load on the shaft bearing etc.

Applications

Gerotors are widely used in industries and are produced in variety of shapes and sizes by a number of different methods. These pumps are primarily suitable for low pressure applications such as lubrication systems or hot oil filtration systems, but can also be found in low to moderate pressure hydraulic applications. However common applications are as follows:

- Light fuel oils
- Lube oil
- Cooking oils
- Hydraulic fluid

Module 5: Hydraulic Systems

Lecture 3

Hydraulic Pumps -2

1. Vane Pumps

In the previous lecture we have studied the gear pumps. These pumps have a disadvantage of small leakage due to gap between gear teeth and the pump housing. This limitation is overcome in vane pumps. The leakage is reduced by using spring or hydraulically loaded vanes placed in the slots of driven rotor. Capacity and pressure ratings of a vane pump are generally lower than the gear pumps, but reduced leakage gives an improved volumetric efficiency of around 95%.

Vane pumps are available in a number of vane configurations including sliding vane, flexible vane, swinging vane, rolling vane, and external vane etc. Each type of vane pump has its own advantages. For example, external vane pumps can handle large solids. Flexible vane pumps can handle only the small solids but create good vacuum. Sliding vane pumps can run dry for short periods of time and can handle small amounts of vapor. The vane pumps are known for their dry priming, ease of maintenance, and good suction characteristics. The operating range of these pumps varies from $-32\text{ }^{\circ}\text{C}$ to $260\text{ }^{\circ}\text{C}$.

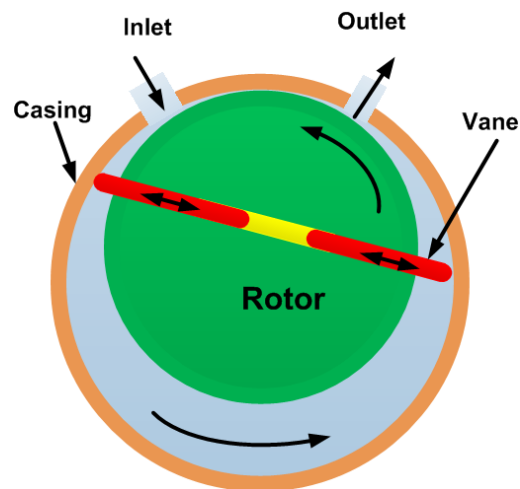


Figure 5.3.1 Schematic of working principle of vane pump

The schematic of vane pump working principle is shown in figure 5.3.1. Vane pumps generate a pumping action by tracking of vanes along the casing wall. The vane pumps generally consist of a rotor, vanes, ring and a port plate with inlet and outlet ports. The rotor in a vane pump is connected to the prime mover through a shaft. The vanes are

located on the slotted rotor. The rotor is eccentrically placed inside a cam ring as shown in the figure. The rotor is sealed into the cam by two side plates. When the prime mover rotates the rotor, the vanes are thrown outward due to centrifugal force. The vanes track along the ring. It provides a tight hydraulic seal to the fluid which is more at the higher rotation speed due to higher centrifugal force. This produces a suction cavity in the ring as the rotor rotates. It creates vacuum at the inlet and therefore, the fluid is pushed into the pump through the inlet. The fluid is carried around to the outlet by the vanes whose retraction causes the fluid to be expelled. The capacity of the pump depends upon the eccentricity, expansion of vanes, width of vanes and speed of the rotor. It can be noted that the fluid flow will not occur when the eccentricity is zero. These pumps can handle thin liquids (low viscosity) at relatively higher pressure. These pumps can be run dry for a small duration without any failure. These pumps develop good vacuum due to negligible leakage. However, these pumps are not suitable for high speed applications and for the high viscosity fluids or fluids carrying some abrasive particles. The maintenance cost is also higher due to many moving parts. These pumps have various applications for the pumping of following fluids:

- Aerosol and Propellants
- Aviation Service - Fuel Transfer, Deicing
- Auto Industry - Fuels, Lubes, Refrigeration Coolants
- Bulk Transfer of LPG and NH₃
- LPG Cylinder Filling
- Alcohols
- Refrigeration - Freons, Ammonia
- Solvents
- Aqueous solutions

1.1 Unbalanced Vane pump

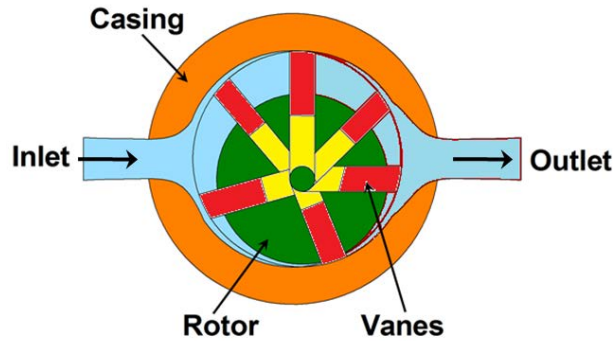


Figure 5.3.2 Unbalanced vane pump

In practice, the vane pumps have more than one vane as shown in figure 5.3.2. The rotor is offset within the housing, and the vanes are constrained by a cam ring as they cross inlet and outlet ports. Although the vane tips are held against the housing, still a small amount of leakage exists between rotor faces and body sides. Also, the vanes compensate to a large degree for wear at the vane tips or in the housing itself. The pressure difference between outlet and inlet ports creates a large amount of load on the vanes and a significant amount of side load on the rotor shaft which can lead to bearing failure. This type of pump is called as unbalanced vane pump.

1.2 Balanced vane pump

Figure 5.3.3 shows the schematic of a balanced vane pump. This pump has an elliptical cam ring with two inlet and two outlet ports. Pressure loading still occurs in the vanes but the two identical pump halves create equal but opposite forces on the rotor. It leads to the zero net force on the shaft and bearings. Thus, lives of pump and bearing increase significantly. Also the sounds and vibrations decrease in the running mode of the pump.

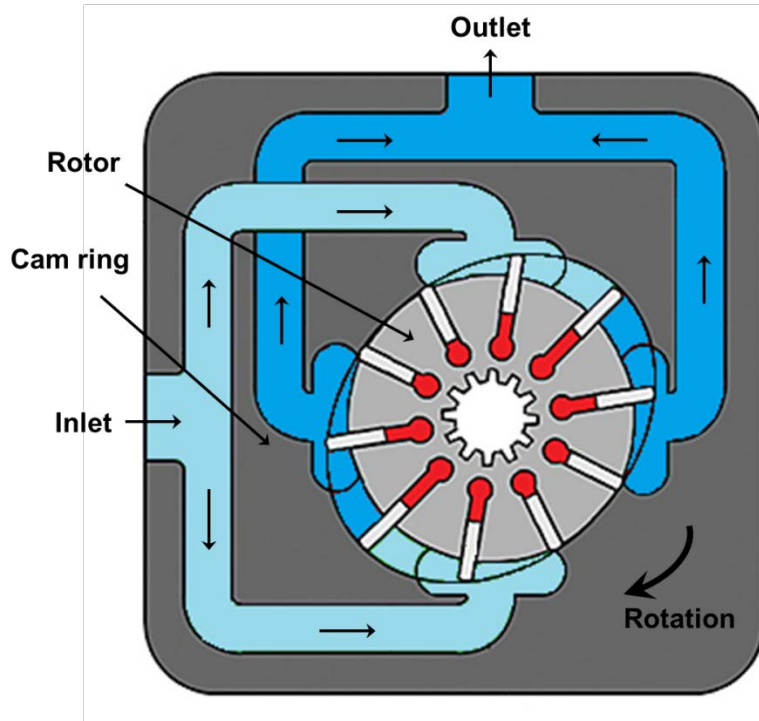


Figure 5.3.3 Balanced Vane Pump

1.3 Adjustable vane pump

The proper design of pump is important and a challenging task. In ideal condition, the capacity of a pump should be exactly same to load requirements. A pump with larger capacity wastes energy as the excess fluid will pass through the pressure relief valve. It also leads to a rise in fluid temperature due to energy conversion to the heat instead of useful work and therefore it needs some external cooling arrangement. Therefore, the higher capacity pump increases the power consumption and makes the system bulky and costly. Pumps are generally available with certain standard capacities and the user has to choose the next available capacity of the pump. Also, the flow rate from the pump in most hydraulic applications needs to be varying as per the requirements. Therefore, some vane pumps are also available with adjustable capacity as shown in figure 5.3.4. This can be achieved by adjusting a positional relationship between rotor and the inner casing by the help of an external controlling screw. These pumps basically consist of a rotor, vanes, cam ring, port plate, thrust bearing for guiding the cam ring and a discharge control screw by which the position of the cam ring relative to the rotor can be varied. In general, the adjustable vane pumps are unbalanced pump type.

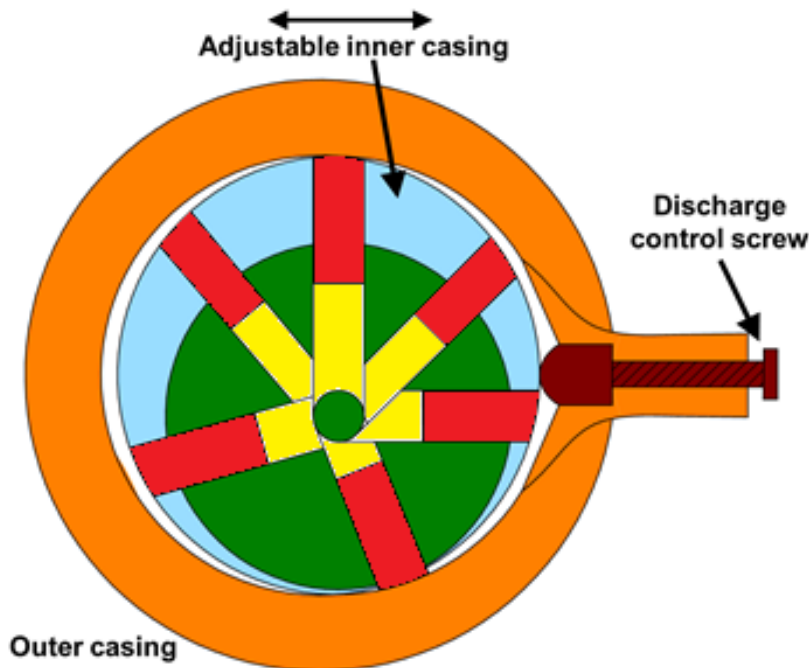


Figure 5.3.4 Adjustable vane pump

The amount of fluid that is displaced by a vane pump running at a constant speed is determined by the maximum extension of the vanes and the vanes width. However, for a pump running in operation, the width of vanes cannot be changed but the distance by which the vanes are extended can be varied. This is possible by making a provision for changing the position of the cam ring (adjustable inner casing) relative to the rotor as shown in figure 5.3.4. The eccentricity of rotor with respect to the cam ring is adjusted by

the movement of the screw. The delivery volume increases with increase in the eccentricity. This kind of arrangement can be used to achieve a variable volume from the pump and is known as variable displacement vane pump.

In general, the adjusted vane pumps are pressure compensated. It means that the discharge is controlled by pre-adjusted value and when the discharge pressure reaches a certain (adjusted) value; the pumping action ceases. This mechanism is accomplished by using a compensating spring to offset the cam ring. Initially, the eccentricity is maximum because the discharge pressure is zero and spring force keeps the cam ring at the extreme right position. As the discharge pressure increases, it acts on the inner contour of the cam ring. It pushes the cam ring towards the left against the spring force and hence the eccentricity reduces and hence the discharge through the pump reduces. When the discharge pressure becomes high enough to overcome the entire spring force; the compensator spring will compress until the zero eccentricity is achieved. In this condition, the pumping action ceases and the fluid flow (except small leakages) does not occur. Therefore, the system pressure can be adjusted by setting the compensator spring. These pumps ensure their own protection against excessive system pressure and do not rely on the safety control devices of the hydraulic system. These pumps are used as energy savings devices and have been used in many applications, including automotive transmissions.

2. Piston pumps

Piston pumps are meant for the high-pressure applications. These pumps have high-efficiency and simple design and needs lower maintenance. These pumps convert the rotary motion of the input shaft to the reciprocating motion of the piston. These pumps work similar to the four stroke engines. They work on the principle that a reciprocating piston draws fluid inside the cylinder when the piston retracts in a cylinder bore and discharge the fluid when it extends. Generally, these pumps have fixed inclined plate or variable degree of angle plate known as swash plate (shown in Figure 5.3.5 and Figure 5.3.6). When the piston barrel assembly rotates, the swash plate in contact with the piston slippers slides along its surface. The stroke length (axial displacement) depends on the inclination angle of the swash plate. When the swash plate is vertical, the reciprocating motion does not occur and hence pumping of the fluid does not take place. As the swash plate angle increases, the piston reciprocates inside the cylinder barrel. The stroke length increases with increase in the swash plate angle and therefore volume of pumping fluid increases. During one half of the rotation cycle, the pistons move out of the cylinder barrel and the volume of the barrel increases. During another half of the rotation, the pistons move into the cylinder barrel and the barrel volume decreases. This phenomenon is responsible for drawing the fluid in and pumping it out. These pumps are positive displacement pump and can be used for both liquids and gases. Piston pumps are basically of two types:

- i. Axial piston pumps
- ii. Radial piston pumps

2.1 Axial Piston Pump

Axial piston pumps are positive displacement pumps which convert rotary motion of the input shaft into an axial reciprocating motion of the pistons. These pumps have a number of pistons (usually an odd number) in a circular array within a housing which is commonly referred to as a cylinder block, rotor or barrel. These pumps are used in jet aircraft. They are also used in small earthmoving plants such as skid loader machines. Another use is to drive the screws of torpedoes. In general, these systems have a maximum operating temperature of about 120 °C. Therefore, the leakage between cylinder housing and body block is used for cooling and lubrication of the rotating parts. This cylinder block rotates by an integral shaft aligned with the pistons. These pumps have sub-types as:

- a. Bent axis piston pumps
- b. Swash plate axial piston pump

2.1.1 Bent-Axis Piston Pumps

Figure 5.3.5 shows the schematic of bent axis piston pump. In these pumps, the reciprocating action of the pistons is obtained by bending the axis of the cylinder block. The cylinder block rotates at an angle which is inclined to the drive shaft. The cylinder block is turned by the drive shaft through a universal link. The cylinder block is set at an offset angle with the drive shaft. The cylinder block contains a number of pistons along its periphery. These piston rods are connected with the drive shaft flange by ball-and-socket joints. These pistons are forced in and out of their bores as the distance between the drive shaft flange and the cylinder block changes. A universal link connects the block to the drive shaft, to provide alignment and a positive drive.

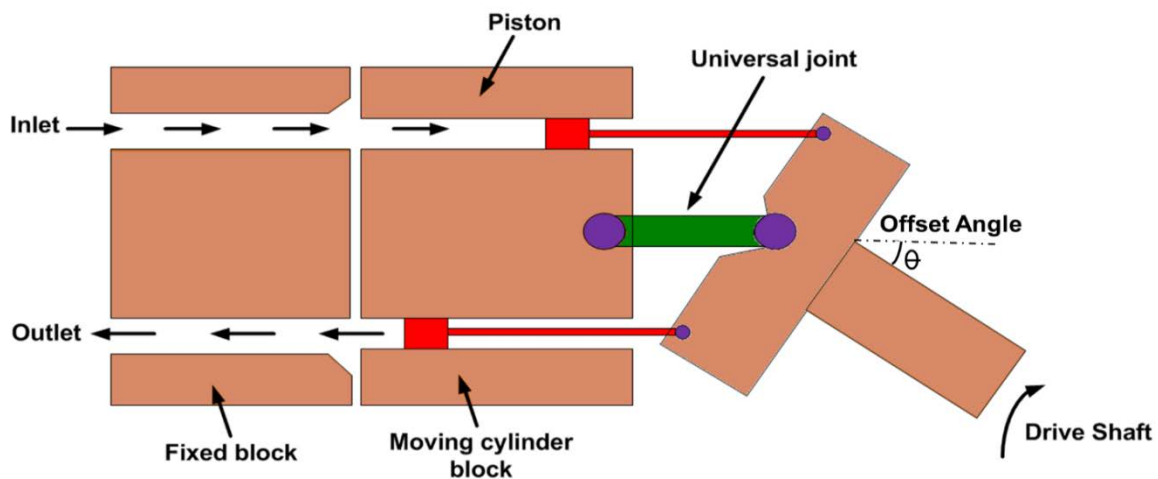


Figure 5.3.5 Bent axis piston pump

The volumetric displacement (discharge) of the pump is controlled by changing the offset angle. It makes the system simple and inexpensive. The discharge does not occur when the cylinder block is parallel to the drive shaft. The offset angle can vary from 0° to 40° . The fixed displacement units are usually provided with 23° or 30° offset angles while the variable displacement units are provided with a yoke and an external control mechanism to change the offset angle. Some designs have arrangement of moving the yoke over the center position to reverse the fluid flow direction. The flow rate of the pump varies with the offset angle θ . There is no flow when the cylinder block centerline is parallel to the drive shaft centerline (offset angle is 0°). The total fluid flow per stroke can be given as:

$$V_d = nAD \tan \theta \quad (5.3.1)$$

The flow rate of the pump can be given as:

$$V_d = nADN \tan \theta \quad (5.3.2)$$

$$\text{here, } \tan \theta = \frac{S}{D} \quad (5.3.3)$$

where S is the piston stroke, D is piston diameter, n is the number of pistons, N is the speed of pump and A is the area of piston.

2.1.2 Swash Plate Axial Piston Pump

A swash plate is a device that translates the rotary motion of a shaft into the reciprocating motion. It consists of a disk attached to a shaft as shown in Figure 5.3.6. If the disk is aligned perpendicular to the shaft; the disk will turn along with the rotating shaft without any reciprocating effect. Similarly, the edge of the inclined shaft will appear to oscillate along the shaft's length. This apparent linear motion increases with increase in the angle between disk and the shaft (offset angle). The apparent linear motion can be converted into an actual reciprocating motion by means of a follower that does not turn with the swash plate.

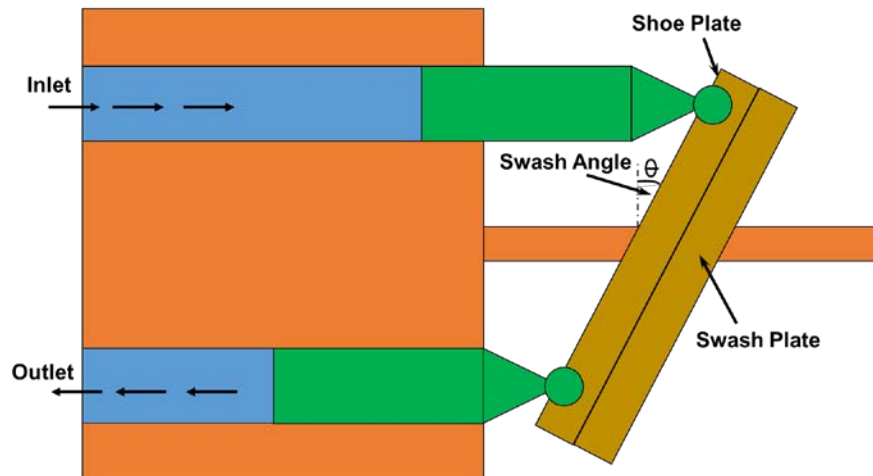


Figure 5.3.6 Swash plate piston pump

In swash plate axial piston pump a series of pistons are aligned coaxially with a shaft through a swash plate to pump a fluid. The schematic of swash plate piston pump is shown in Figure 5.3.6. The axial reciprocating motion of pistons is obtained by a swash plate that is either fixed or has variable degree of angle. As the piston barrel assembly rotates, the piston rotates around the shaft with the piston shoes in contact with the swash plate. The piston shoes follow the angled surface of the swash plate and the rotational motion of the shaft is converted into the reciprocating motion of the pistons. When the swash plate is perpendicular to the shaft; the reciprocating motion to the piston does not occur. As the swash plate angle increases, the piston follows the angle of the swash plate surface and hence it moves in and out of the barrel. The piston moves out of the cylinder barrel during one half of the cycle of rotation thereby generating an increasing volume, while during other half of the rotating cycle, the pistons move into the cylinder barrel generating a decreasing volume. This reciprocating motion of the piston results in the drawing in and pumping out of the fluid. Pump capacity can be controlled by varying the swash plate angle with the help of a separate hydraulic cylinder. The pump capacity (discharge) increases with increase in the swash plate angle and vice-versa. The cylinder block and the drive shaft in this pump are located on the same centerline. The pistons are connected through shoes and a shoe plate that bears against the swash plate. These pumps can be designed to have a variable displacement capability. It can be done by mounting

the swash plate in a movable yoke. The swash plate angle can be changed by pivoting the yoke on pintles.

2.2 Radial Piston Pump

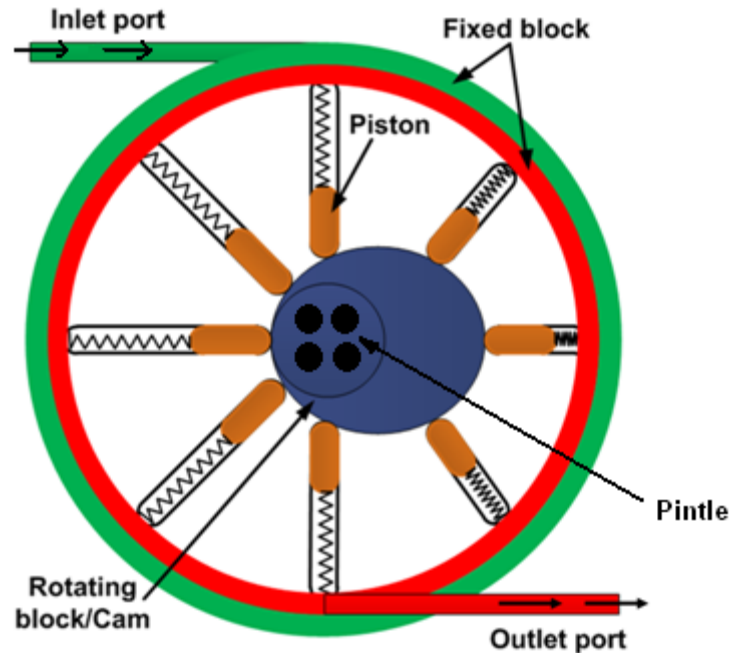


Figure 5.3.7 Radial piston pump

The typical construction of radial piston pump is shown in Figure 5.3.7. The piston pump has pistons aligned radially in a cylindrical block. It consists of a pintle, a cylinder barrel with pistons and a rotor containing a reaction ring. The pintle directs the fluid in and out of the cylinder. Pistons are placed in radial bores around the rotor. The piston shoes ride on an eccentric ring which causes them to reciprocate as they rotate. The eccentricity determines the stroke of the pumping piston. Each piston is connected to inlet port when it starts extending while it is connected to the outlet port when start retracting. This connection to the inlet and outlet port is performed by the timed porting arrangement in the pintle. For initiating a pumping action, the reaction ring is moved eccentrically with respect to the pintle or shaft axis. As the cylinder barrel rotates, the pistons on one side travel outward. This draws the fluid in as the cylinder passes the suction port of the pintle. It is continued till the maximum eccentricity is reached. When the piston passes the maximum eccentricity, pintle is forced inwards by the reaction ring. This forces the fluid to flow out of the cylinder and enter in the discharge (outlet) port of the pintle.

The radial piston pump works on high pressure (up to 1000 bar). It is possible to use the pump with various hydraulic fluids like mineral oil, biodegradable oil, HFA (oil in water), HFC (water-glycol), HFD (synthetic ester) or cutting emulsion. This is because the parts are hydrostatically balanced. It makes the pump suitable for the many applications such as machine tools (displace of cutting emulsion, supply for hydraulic equipment like cylinders), high pressure units (overload protection of presses), test rigs,

automotive sector (automatic transmission, hydraulic suspension control in upper-class cars), plastic (powder injection molding) and wind energy etc.

3. Combination Pump

There are two basic requirements for load lifting or load applying by a hydraulic ram. First, there is a need of large volume of fluid at a low pressure when the cylinder extends or retracts. The low pressure is required to overcome the frictional resistance. The second requirement is that a high pressure is needed, when the load is gripped.

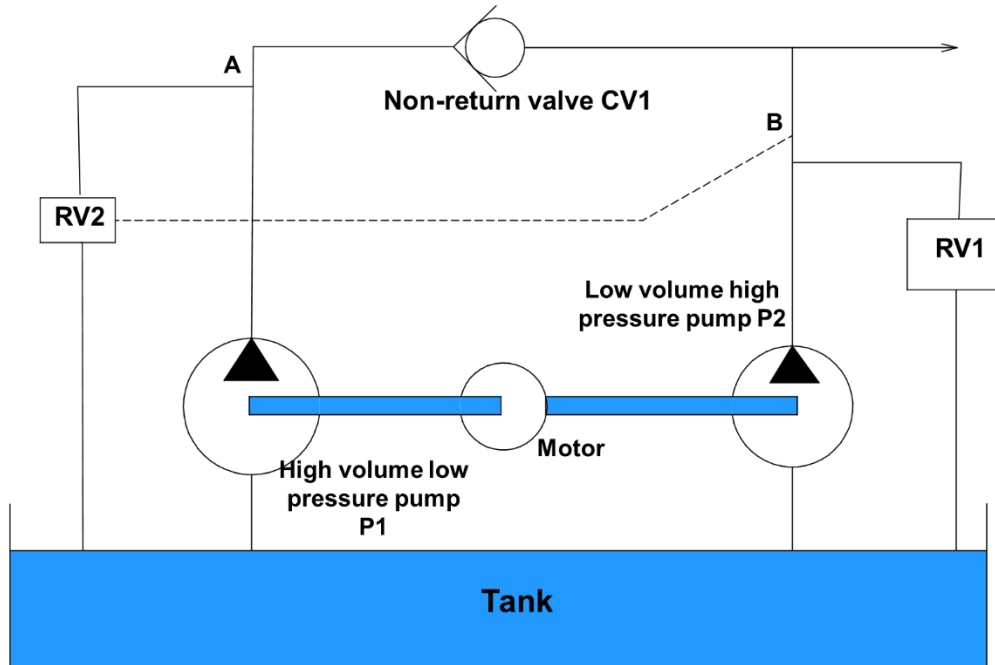


Figure 5.3.8 Combination pump

This type of requirements can be fulfilled by an arrangement as shown in figure 5.3.8. In this system two separate pumps are driven by a common electrical motor. Pump P1 is a high pressure low volume pump and pump P2 is a high volume low pressure pump. The hydraulic system is associated with relief valves RV1 and RV2 and a one-way check valve CV1. This kind of arrangement allows the fluid flow from left to right, but blocks in the reverse direction.

The pressure relief valve RV1 is a normal high pressure valve. The pressure relief valve RV2 is not operated by the pressure at point A, however, it is remotely operated by the pressure at point B. This can be achieved with the balanced piston valve. In low pressure mode both relief valves are closed and both pumps P1 and P2 deliver fluid to the load but the majority comes from the pump P2 as its capacity is higher.

When the load is in the holding mode, the pressure at B rises and relief valve RV2 opens. It results in all the fluid from pump P2 to return straight to the tank directly and the pressure at A to fall to a low value. The check valve CV1 stops the fluid from pump P1

pass it back to the tank via relief valve RV2, consequently pressure at B rises to the level set by relief valve RV1.

This kind of arrangement saves energy as the large volume of fluid from pump P2 is returned to the tank at a very low pressure, and only a small volume of fluid from pump P1 is returned at a high pressure.

In general the applications of Hydraulic Pumps can be summarized as,

- Hydraulic pumps are used to transfer power via hydraulic liquid. These pumps have a number of applications in automobiles, material handling systems, automatic transmissions, controllers, compressors and household items.
- The hand operated hydraulic pump is used in a hydraulic jack where many strokes of the pump apply hydraulic pressure to lift the ram.
- A backhoe uses an engine driven hydraulic pump to drive the articulating parts of the mechanical hoe.
- The hydraulic pumps are commonly used in the automotive vehicles especially in power steering systems.
- The lift system of tractor is operated by the hydraulic pumps. These are used in automatic transmissions and material handling systems in industries.
- Many precise controllers are developed by using hydraulic pumps. The commonly used compressor is operated by reciprocating pumps.
- The hydraulic pumps are also used in routine household systems like power lift and air-conditions. Therefore, it can be said that the hydraulic pumps have significant applications in industries as well as ones routine life.

Module 5: Hydraulic Systems

Lecture 4

Control Valves -1

In a hydraulic system, the hydraulic energy available from a pump is converted into motion and force by means of an actuator. The control of these mechanical outputs (motion and force) is one of the most important functions in a hydraulic system. The proper selection of control selection ensures the desired output and safe function of the system. In order to control the hydraulic outputs, different types of control valves are required. It is important to know various types of control valves and their functions. This not only helps to design a proper hydraulic system but also helps to discover the innovative ways to improve the existing systems. In this lecture and next few lectures, various types of valves will be discussed.

There are basically three types of valves employed in hydraulic systems:

1. Directional control valves
2. Flow control valves
3. Pressure control valves

1. Direction control valve

Directional control valves are used to control the distribution of energy in a fluid power system. They provide the direction to the fluid and allow the flow in a particular direction. These valves are used to control the start, stop and change in direction of the fluid flow. These valves regulate the flow direction in the hydraulic circuit. These control valves contain ports that are external openings for the fluid to enter and leave. The number of ports is usually identified by the term 'way'. For example, a valve with four ports is named as four-way valve. The fluid flow rate is responsible for the speed of actuator (motion of the output) and should controlled in a hydraulic system. This operation can be performed by using flow control valves. The pressure may increase gradually when the system is under operation. The pressure control valves protect the system by maintaining the system pressure within the desired range. Also, the output force is directly proportional to the pressure and hence, the pressure control valves ensure the desired force output at the actuator.

Directional control valves can be classified in the following manner:

1. Type of construction:
 - Poppet valves
 - Spool valves

2. Number of ports:
 - Two- way valves
 - Three – way valves
 - Four- way valves.
3. Number of switching position:
 - Two – position
 - Three - position
4. Actuating mechanism:
 - Manual actuation
 - Mechanical actuation
 - Solenoid actuation
 - Hydraulic actuation
 - Pneumatic actuation
 - Indirect actuation

1.1 Type of construction

1.1.1 Check Valves

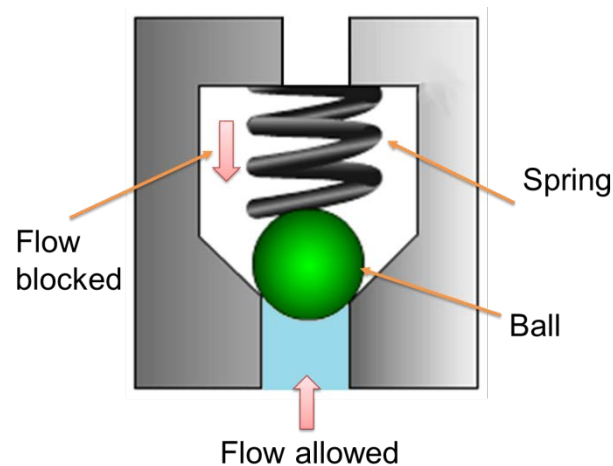


Figure 5.4.1 Inline check valve

These are unidirectional valves and permit the free flow in one direction only. These valves have two ports: one for the entry of fluid and the other for the discharge. They consist of a housing bore in which a ball or poppet is held by a small spring force. The valve having a ball as a closing member is known as a ball check valve. Various types of check valves are available for a range of applications. These valves are generally small sized, simple in construction and inexpensive. Generally, check valves are automatically operated. Human intervention or any external control system is not

required. These valves can wear out or can generate the cracks after prolonged usage and therefore they are mostly made of plastics for easy repair and replacements.

An important concept in check valves is the cracking pressure. The check valve is designed for a specific cracking pressure which is the minimum upstream pressure at which the valve operates. The simplest check valve is an inline check valve as shown in Figure 5.4.1. The ball is held against the valve seat by a spring force. It can be observed from the figure that the fluid flow is not possible from the spring side but the fluid from opposite side can pass by lifting the ball against. However, there is some pressure drop across the valve due to restriction by the spring force. Therefore these valves are not suitable for the application of high flow rate. When the operating pressure increases the valve becomes more tightly seated in this design.

The advantages of the poppet valves include no leakage, long life and suitability with high pressure applications. These valves are commonly used in liquid or gel mini-pump dispenser spigots, spray devices, some rubber bulbs for pumping air, manual air pumps, and refillable dispensing syringes. Sometimes, the right angle check valve as shown in Figure 5.4.2 is used for the high flow rate applications. The pressure drop is comparatively less in right angle check valve.

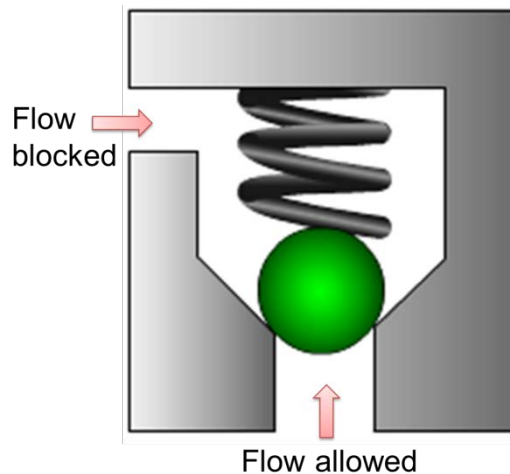


Figure 5.4.2 Right angle check valve

When the closing member is not a ball but a poppet energized by a spring is known as poppet valve. The typical poppet valve is shown in Figure 5.4.3. Some valves are meant for an application where free flow is required in one direction and restricted flow required in another direction. These types of valves are called as restriction check valve (see Figure 5.4.3). These valves are used when a direction sensitive flow rate is required. For example, the different actuator speeds are required in both the directions. The flow adjustment screw can be used to set the discharge (flow rate) in the restricted direction.

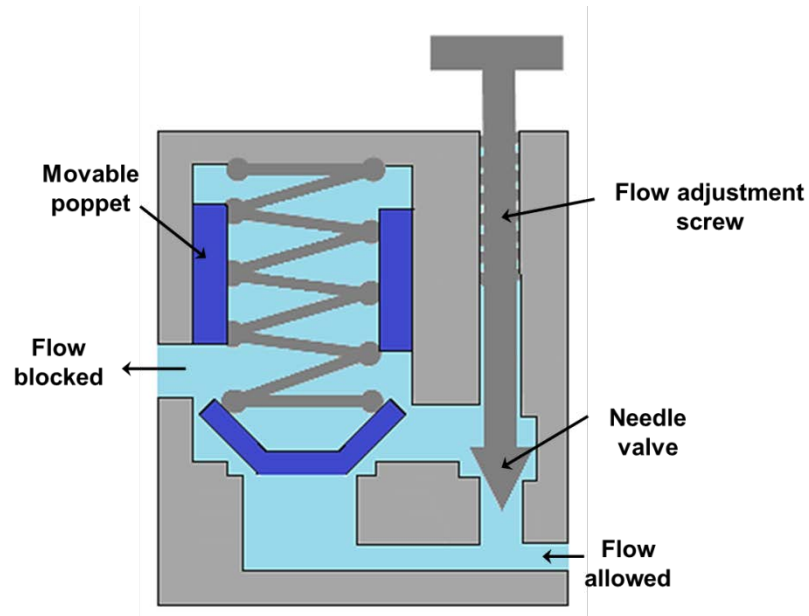


Figure 5.4.3 Restriction check valve

Another important type of check valve known as pilot operated check valve which is shown in figure 5.4.4. The function of the pilot operated check valve is similar to a normal check valve unless it gets an extra pressure signal through a pilot line. Pilot allows free flow in one direction and prevents the flow in another direction until the pilot pressure is applied. But when pilot pressure acts, the poppet opens and the flow is blocked from both the sides. These valves are used to stop the fluid suddenly.

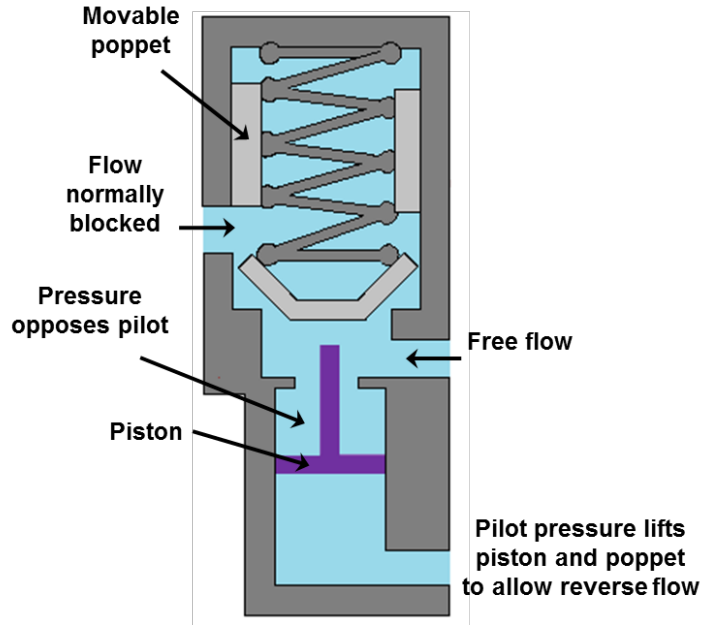


Figure 5.4.4 Pilot operated check valve

1.1.2 Spool valve

The spool valves derive their name from their appearance. It consists of a shaft sliding in a bore which has large groove around the circumference. This type of construction makes it look like a spool. The spool is sealed along the clearance between moving spool and housing (valve body). The quality of seal or the amount of leakage depends on the amount of clearance, viscosity of fluid and the level of the pressure. The grooves guide the fluid flow by interconnecting or blocking the holes (ports). The spool valves are categorized according to the number of operating positions and the way hydraulic lines interconnections. One of the simplest two way spool valve is shown in Figure 5.4.5. The standard terms are referred as Port 'P' is pressure port, Port 'T' is tank port and Port 'A' and Port 'B' are the actuator (or working) ports. The actuators can move in forward or backward direction depending on the connectivity of the pressure and tank port with the actuators port.

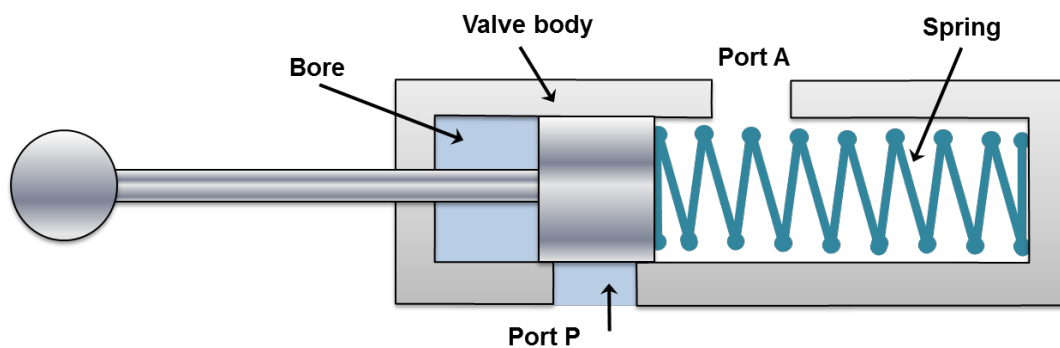


Figure 5.4.5 Valve closed

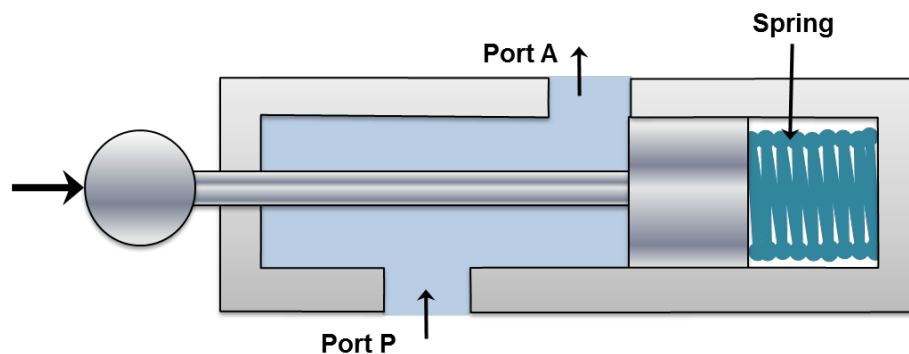


Figure 5.4.6 Valve opened by actuation

1.2 Number of ports

1.2.1 Two way valves

Two way valves have only two ports as shown in Figure 5.4.5 and Figure 5.4.6. These valves are also known as on-off valves because they allow the fluid flow only in direction. Normally, the valve is closed. These valves are available as normally open and normally closed function. These are the simplest type of spool valves. When actuating force is not applied to the right, the port P is not connected with port A as shown in figure 5.4.5. Therefore, the actuation does not take place. Similarly, Figure 5.4.6 shows the two-way spool valve in the open condition. Here, the pressure port P is connected with the actuator port A.

1.2.2 Three way valves

When a valve has one pressure port, one tank port and one actuating port as shown in Figures 5.4.7 and 5.4.8, it is known as three way valve. In this valve, the pressure port pressurizes one port and exhausts another one. As shown in figures, only one actuator port is opened at a time. In some cases a neutral position is also available when both the ports are blocked. Generally, these valves are used to operate single acting cylinders.

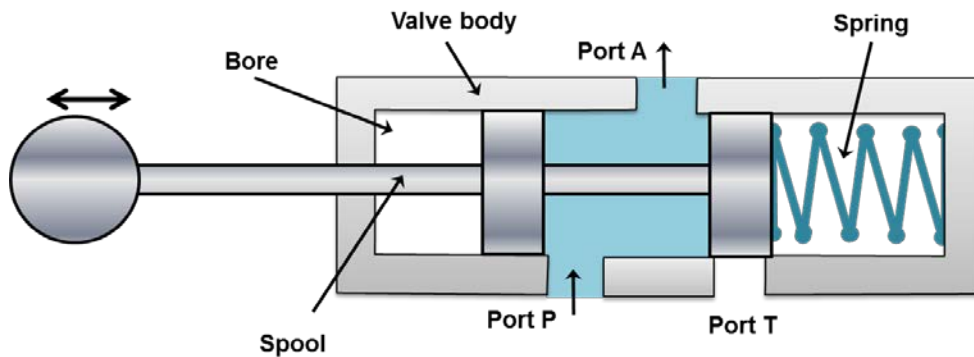


Figure 5.4.7 Three way valve: P to A connected and T is blocked

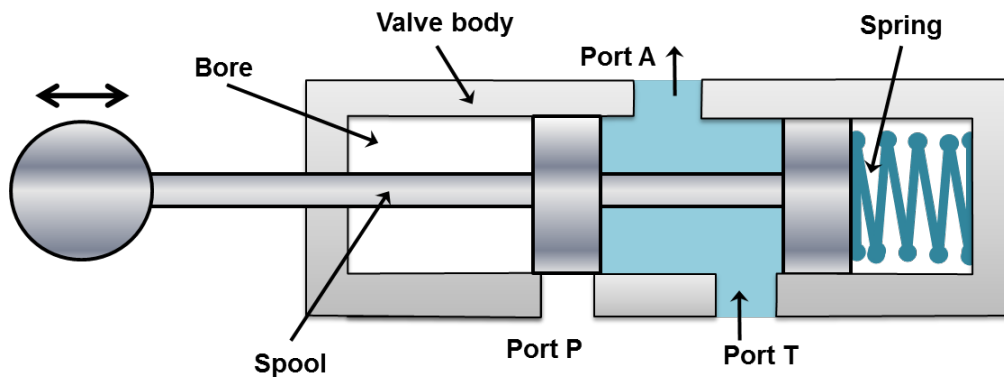


Figure 5.4.8 Three way valve in closed position

1.2.3 Four way valves

Figure 5.4.9 shows a four-way valve. It is generally used to operate the cylinders and fluid motors in both the directions. The four ways are: pump port P, tank port T, and two working ports A and B connected to the actuator. The primary function of a four way valve is to pressurize and exhaust two working ports A and B alternatively.

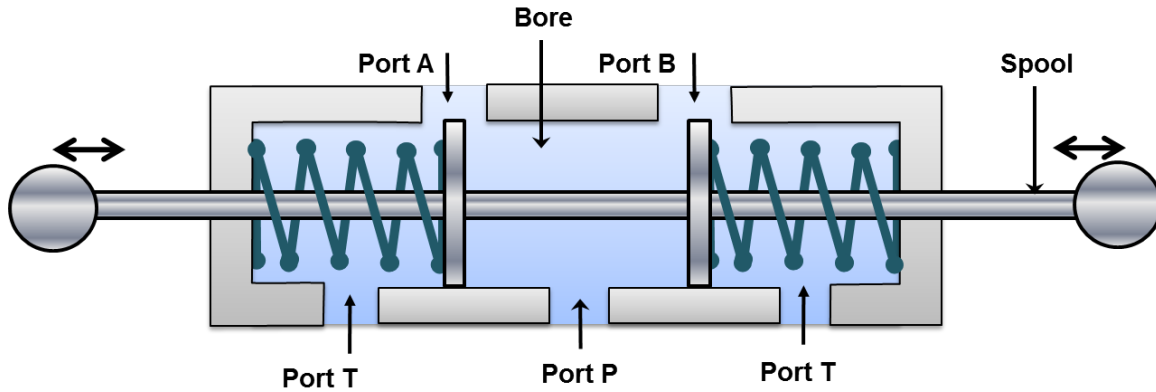


Figure 5.4.9 Three position four way valve in open center mode

Module 5: Hydraulic Systems

Lecture 5

Control valves -2

1. Classification of control valve according to number/ways of switching position

1.1 Three position four way (3/4) valves

Three position four way (3/4) valves are used in double-acting cylinders to perform advance, hold and return operation to the piston. Figures 5.5.1 and 5.5.2 show three position four way valves. These types of valves have three switching positions. They have a variety of possible flow path configurations but have identical flow path configuration. When the centered path is actuated, port A and B are connected with both the ports P and T respectively. In this case, valve is not active because all the ports are open to each other. The fluid flows to the tank at atmospheric pressure. In this position work cannot be done by any part of the system. This configuration helps to prevent heat buildup.

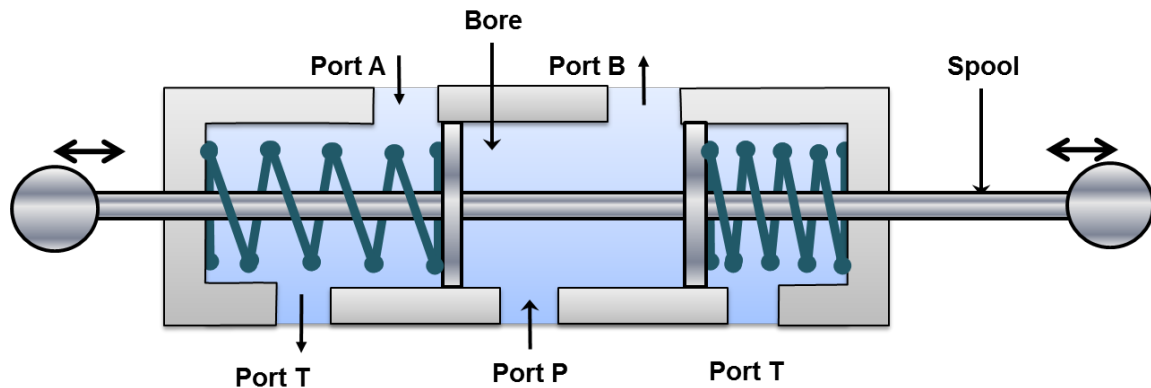


Figure 5.5.1 Three position four way valve: P to B and A to T

When left end (port B) is actuated, the port P is connected with ports B and T is connected with port A as shown in Figure 5.5.1. Similarly, when the right end is actuated the port P is connected to A and working port B is connected to port T as shown in Figure 5.5.2. The three position valves are used when the actuator is needed to stop or hold at some intermediate position. It can also be used when the multiple circuits or functions are accomplished from one hydraulic power source.

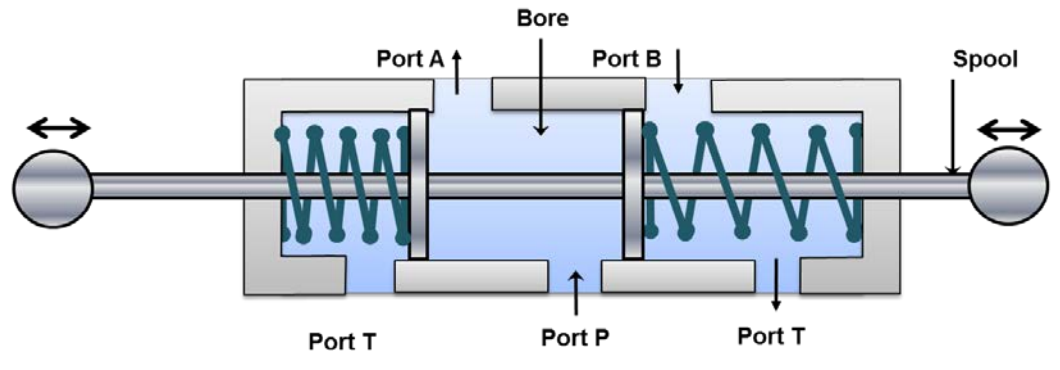


Figure 5.5.2 Three position four way valve: P to A and B to T

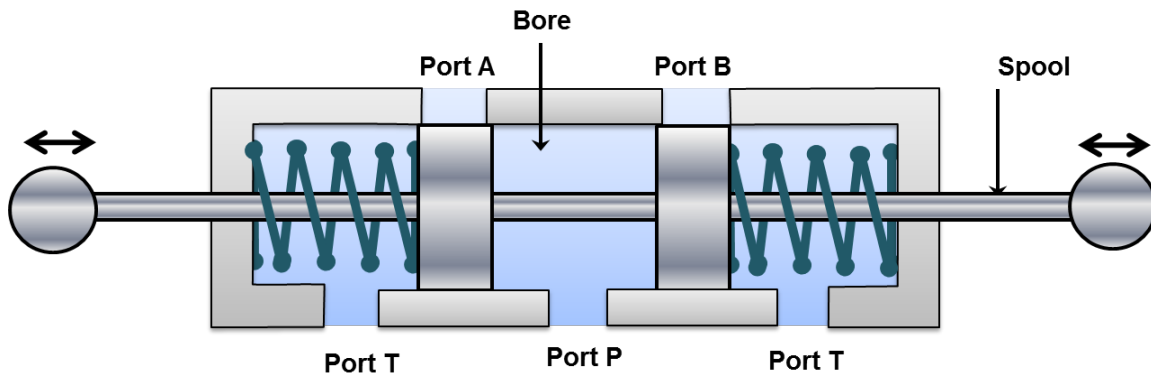


Figure 5.5.3 Three position four way valve: closed center

Figure 5.5.3 shows a three position four way valve in the closed center position. The working of the valve is similar to open center DCV. In closed center DCV all user ports (port A and port B) are closed. Therefore, these ports are hydraulically locked and the actuator cannot be moved by the external load. The pumped fluid flows through the relief valve. The pump works under the high pressure condition which not only wastes the pump power but also causes wear of the pump parts. The fluid temperature also rises due to heat generation by the pump energy transformation. The increase in fluid temperature may lead to the oxidation and viscosity drop of the fluid. The oxidation and viscosity drop reduces the pump life and leakage in the system.

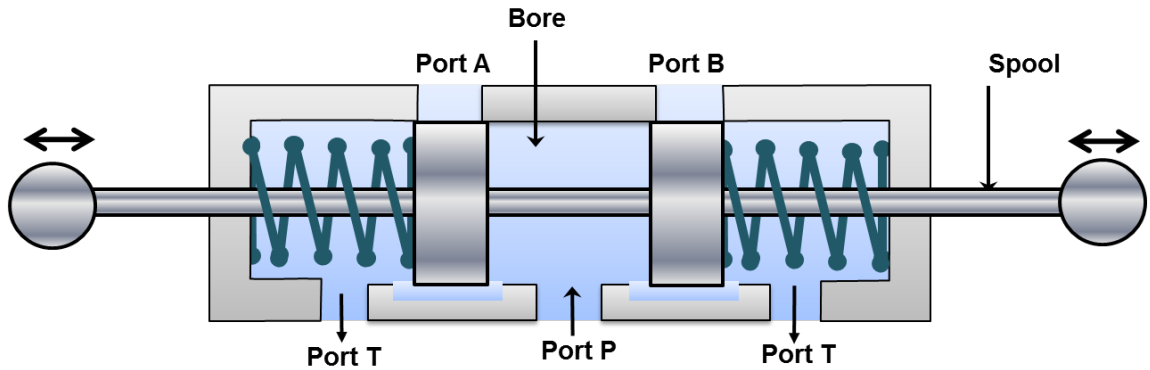


Figure 5.5.4 Tandem centered valve

Figure 5.5.4 shows a tandem center three position four way direction control valve. In this configuration, the working ports A and B are blocked and the pump port P is connected to the tank port T. Tandem center results in the locked actuator. However, pump to tank flow takes place at the atmospheric temperature. This kind of configuration can be used when the load is needed to hold. Disadvantages of high pressure pumping in case of closed center (shown in Figure 5.5.3) can be removed by using this configuration.

The regenerative center is another important type of common center configuration used in hydraulic circuits. Regenerative means the flow is generated from the system itself. Regenerative center is used when the actuator movement in one direction requires two different speeds. For example, the half-length of the stroke requires fast movement during no-load condition and remaining half-length requires slow motion during load conditions. The regenerative center saves the pump power.

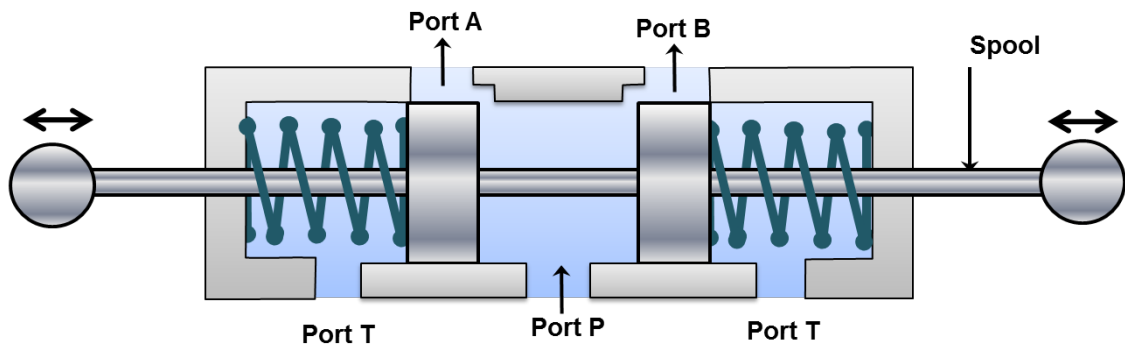


Figure 5.5.5 Regenerative Center

Figure 5.5.5 shows the regenerative configuration for the three position four way (3/4) DCV in its mid position. This configuration increases the piston speed. In the mid position pump P is connected to A and B, and tank port T is blocked.

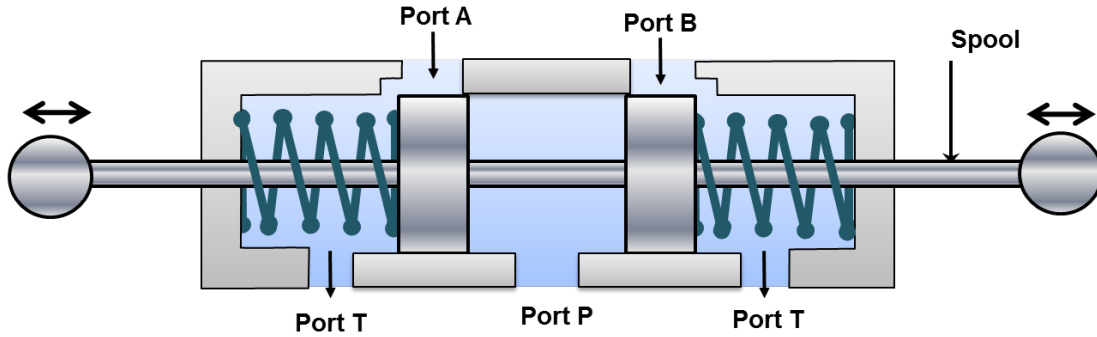


Figure 5.5.6 Floating Center

Figure 5.5.6 shows the floating center 3/4 DCV in its mid position. In this configuration, the pump port is blocked and both the working ports A and B are connected to the tank port T. Therefore, the working ports A and B can be moved freely which is reason they are called as floating center. The pumped fluid passes through the relief valve. Therefore, pump works in the high pressure condition. This configuration is used only in some special cases.

1.2 Two position four way (2/4) valves

The two position four way valves have only two switching positions and do not have any mid position. Therefore, they are also known as impulse valves. The typical connections of 2/4 valves is shown in Figures 5.5.7 and 5.5.8. These valves can be used to operate double acting cylinders. These are also used to reciprocate or hold an actuator. The operation is faster because the distance between ports of these valves is smaller. Hence, these valves are used on machines where fast reciprocation cycles are needed such as punching and stamping etc.

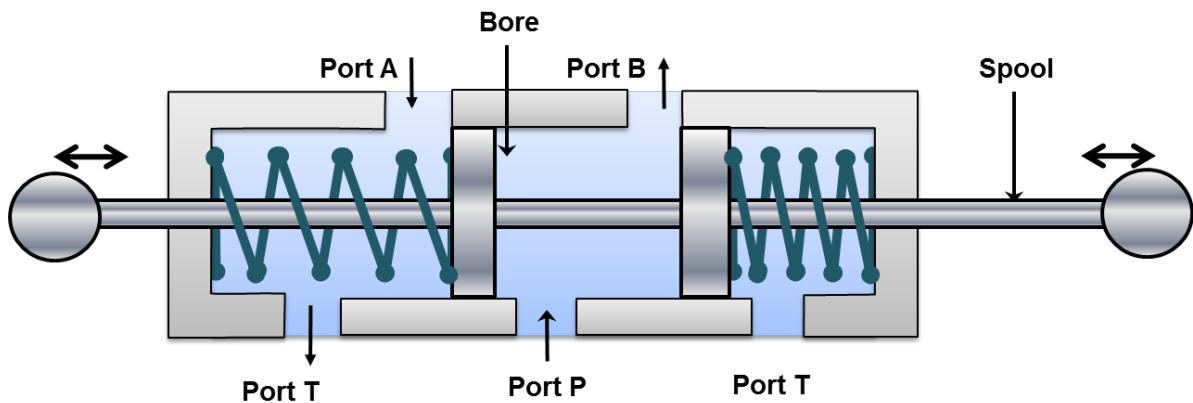


Figure 5.5.7 Two position four way DCV: P to B and A to T

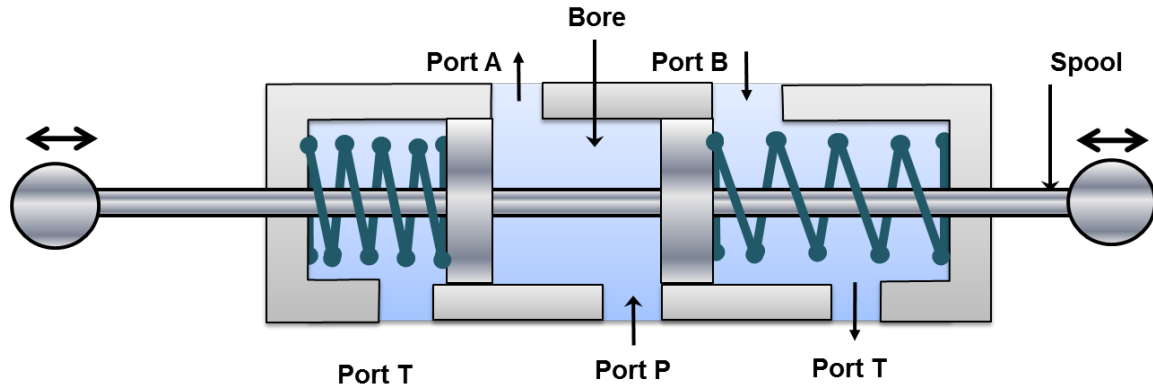


Figure 5.5.8 Two position four way DCV: P to A and B to T

2. Classification based on actuation mechanism

2.1 Manual actuation

In this type, the spool is operated manually. Manual actuators are hand lever, push button and pedals etc.

2.2 Mechanical actuation

The DCV spool can be operated by using mechanical elements such as roller and cam, roller and plunger and rack and pinion etc. In these arrangements, the spool end is of roller or a pinion gear type. The plunger or cam or rack gear is attached to the actuator. Thus, the mechanical elements gain some motion relative to the actuator (cylinder piston) which can be used for the actuation.

2.3 Solenoid actuation

The solenoid actuation is also known as electrical actuation. The schematic of solenoid actuation is shown in Figure 5.5.9. The energized solenoid coil creates a magnetic force which pulls the armature into the coil. This movement of armature controls the spool position. The main advantage of solenoid actuation is its less switching time.

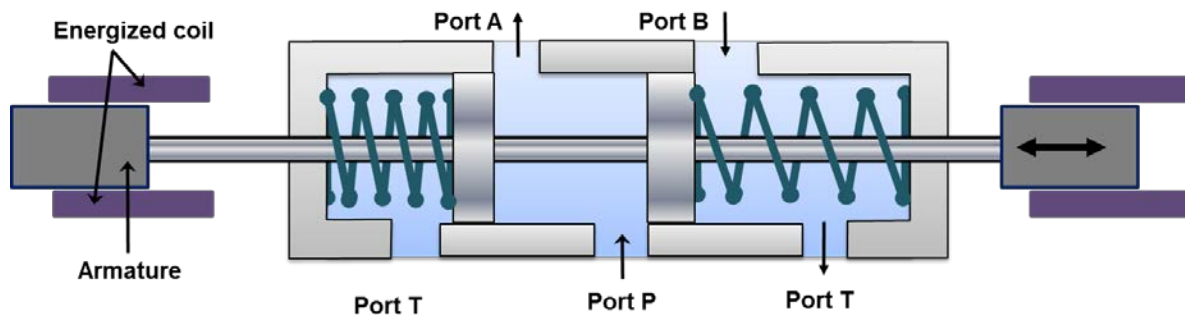


Figure 5.5.9 Working of solenoid to shift spool of valve

2.4 Hydraulic actuation

This type actuation is usually known as pilot-actuated valve and a schematic is shown in Figure 5.5.10. In this type of actuation, the hydraulic pressure is directly applied on the spool. The pilot port is located on one end of the valve. Fluid entering from pilot port operates against the piston and forces the spool to move forward. The needle valve is used to control the speed of the actuation.

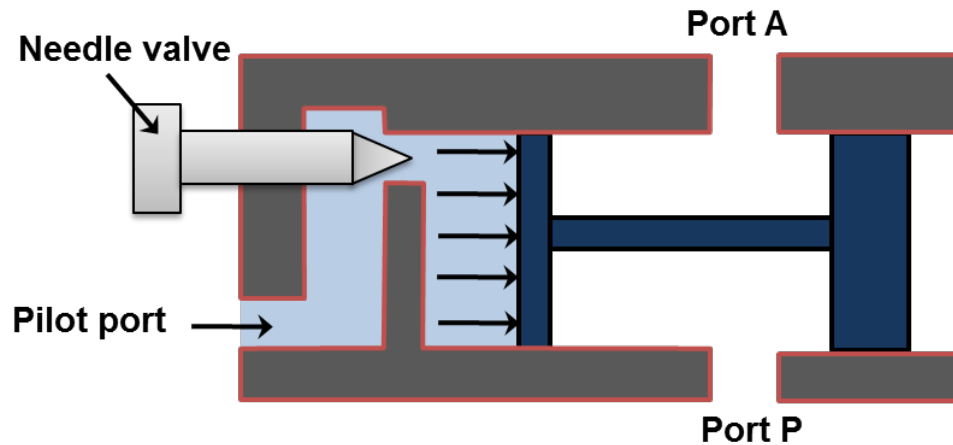


Figure 5.5.10 Pilot actuated DCV

2.5 Pneumatic actuation

DCV can also be operated by applying compressed air against a piston at either end of the valve spool. The construction of the system is similar to the hydraulic actuation as shown in Figure 5.5.10. The only difference would be the actuation medium. The actuation medium is the compressed air in pneumatic actuation system.

2.6 Indirect actuation of directional control valve

The direction control valve can be operated by manual, mechanical, solenoidal (electrical), hydraulic (pilot) and pneumatic actuations. The mode of actuation does not have any influence on the basic operation of the hydraulic circuits. Mostly, the direct actuation is restricted to use with smaller valves only because usually lot of force is not available. The availability of limited force is the greatest disadvantage of the direct actuation systems. In practice, the force required to shift the spool is quite higher. Therefore, the larger valves are often indirectly actuated in sequence. First, the smaller valve is actuated directly and the flow from the smaller valve is directed to either side of the larger valve. The control fluid can be supplied by the same circuit or by a separate circuit. The pilot valve pressure is usually supplied internally. These two valves are often incorporated as a single unit. These valves are also called as Electro-hydraulic operated DCV.

3. Flow Control Valves

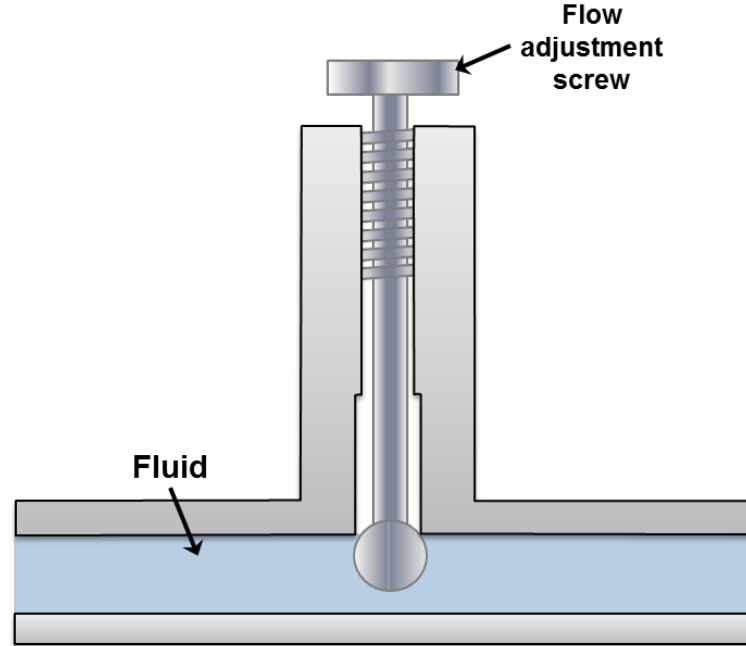


Figure 5.5.11 Flow Control Valve

In practice, the speed of actuator is very important in terms of the desired output and needs to be controlled. The speed of actuator can be controlled by regulating the fluid flow. A flow control valve can regulate the flow or pressure of the fluid. The fluid flow is controlled by varying area of the valve opening through which fluid passes. The fluid flow can be decreased by reducing the area of the valve opening and it can be increased by increasing the area of the valve opening. A very common example to the fluid flow control valve is the household tap. Figure 5.5.11 shows the schematic diagram of a flow control valve. The pressure adjustment screw varies the fluid flow area in the pipe to control the discharge rate.

The pressure drop across the valve may keep on fluctuating. In general, the hydraulic systems have a pressure compensating pump. The inlet pressure remains almost constant but the outlet pressure keeps on fluctuating depending on the external load. It creates fluctuating pressure drop. Thus, the ordinary flow control valve will not be able to maintain a constant fluid flow. A pressure compensated flow control valve maintains the constant flow throughout the movement of a spool, which shifts its position depending on the pressure. Flow control valves can also be affected by temperature changes. It is because the viscosity of the fluid changes with temperature. Therefore, the advanced flow control valves often have the temperature compensation. The temperature compensation is achieved by the thermal expansion of a rod, which compensates for the increased coefficient of discharge due to decreasing viscosity with temperature.

4. Types of Flow Control Valves

The flow control valves work on applying a variable restriction in the flow path. Based on the construction; there are mainly four types viz. plug valve, butterfly valve, ball valve and balanced valve.

4.1 Plug or glove valve

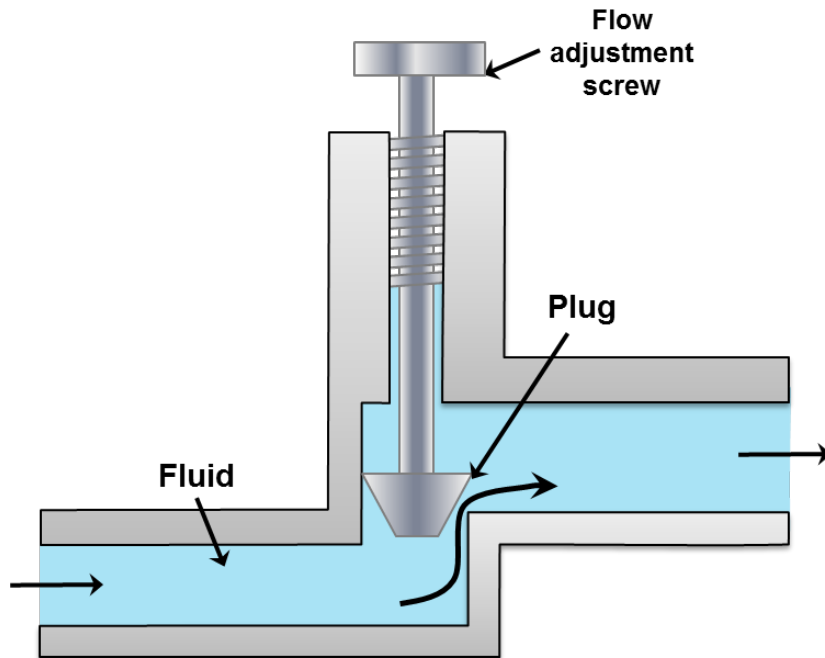


Figure 5.5.12 Plug or glove valve

The plug valve is quite commonly used valve. It is also termed as glove valve. Schematic of plug or glove valve is shown in Figure 5.5.12. This valve has a plug which can be adjusted in vertical direction by setting flow adjustment screw. The adjustment of plug alters the orifice size between plug and valve seat. Thus the adjustment of plug controls the fluid flow in the pipeline. The characteristics of these valves can be accurately predetermined by machining the taper of the plug. The typical example of plug valve is stopcock that is used in laboratory glassware. The valve body is made of glass or teflon. The plug can be made of plastic or glass. Special glass stopcocks are made for vacuum applications. Stopcock grease is used in high vacuum applications to make the stopcock air-tight.

4.2 Butterfly valve

A butterfly valve is shown in Figure 5.5.13. It consists of a disc which can rotate inside the pipe. The angle of disc determines the restriction. Butterfly valve can be made to any size and is widely used to control the flow of gas. These valves have many types which have for different pressure ranges and applications. The resilient butterfly valve uses the flexibility of rubber and has the lowest pressure rating. The high performance butterfly valves have a slight offset in the way the disc is positioned. It increases its sealing ability and decreases the wear. For high-pressure systems, the triple offset butterfly valve is suitable which makes use of a metal seat and is therefore able to withstand high pressure. It has higher risk of leakage on the shut-off position and suffer from the dynamic torque effect. Butterfly valves are favored because of their lower cost and lighter weight. The disc is always present in the flow therefore a pressure drop is induced regardless of the valve position.

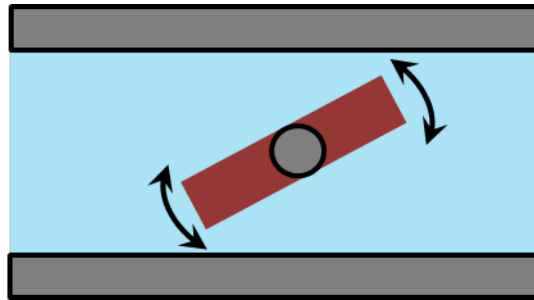


Figure 5.5.13 Butterfly valve

4.3 Ball Valve

The ball valve is shown in Figure 5.5.14. This type of flow control valve uses a ball rotated inside a machined seat. The ball has a through hole as shown in Figure 5.5.14. It has very less leakage in its shut-off condition. These valves are durable and usually work perfectly for many years. They are excellent choice for shutoff applications. They do not offer fine control which may be necessary in throttling applications. These valves are widely used in industries because of their versatility, high supporting pressures (up to 1000 bar) and temperatures (up to 250°C). They are easy to repair and operate.

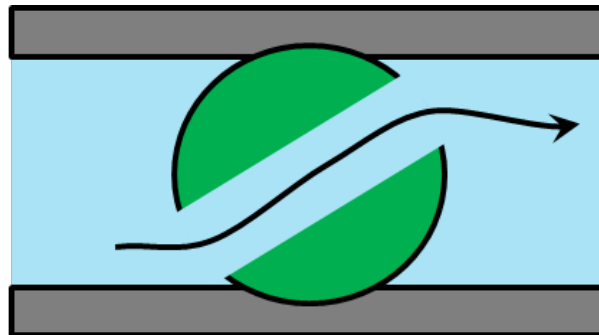


Figure 5.5.14 Ball valve

4.4 Balanced valve

Schematic of a balanced valve is shown in figure 5.5.15. It comprises of two plugs and two seats. The opposite flow gives little dynamic reaction onto the actuator shaft. It results in the negligible dynamic torque effect. However, the leakage is more in these kind of valves because the manufacturing tolerance can cause one plug to seat before the other. The pressure-balanced valves are used in the houses. They provide water at nearly constant temperature to a shower or bathtub despite of pressure fluctuations in either the hot or cold supply lines.

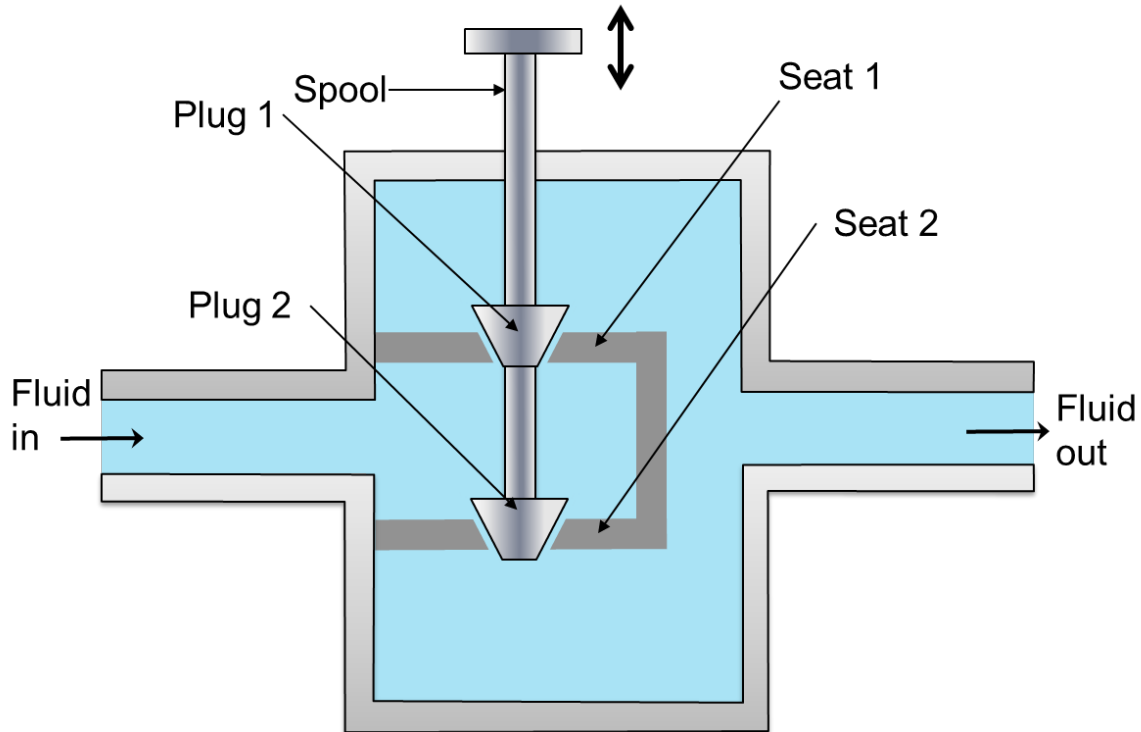


Figure 5.5.15 Balanced valve

Module 5: Hydraulic systems

Lecture 6

Pressure relief valves

The pressure relief valves are used to protect the hydraulic components from excessive pressure. This is one of the most important components of a hydraulic system and is essentially required for safe operation of the system. Its primary function is to limit the system pressure within a specified range. It is normally a closed type and it opens when the pressure exceeds a specified maximum value by diverting pump flow back to the tank. The simplest type valve contains a poppet held in a seat against the spring force as shown in Figure 5.6.1. The fluid enters from the opposite side of the poppet. When the system pressure exceeds the preset value, the poppet lifts and the fluid is escaped through the orifice to the storage tank directly. It reduces the system pressure and as the pressure reduces to the set limit again the valve closes. This valve does not provide a flat cut-off pressure limit with flow rate because the spring must be deflected more when the flow rate is higher. Various types of pressure control valves are discussed in the following sections:

1. Direct type of relief valve

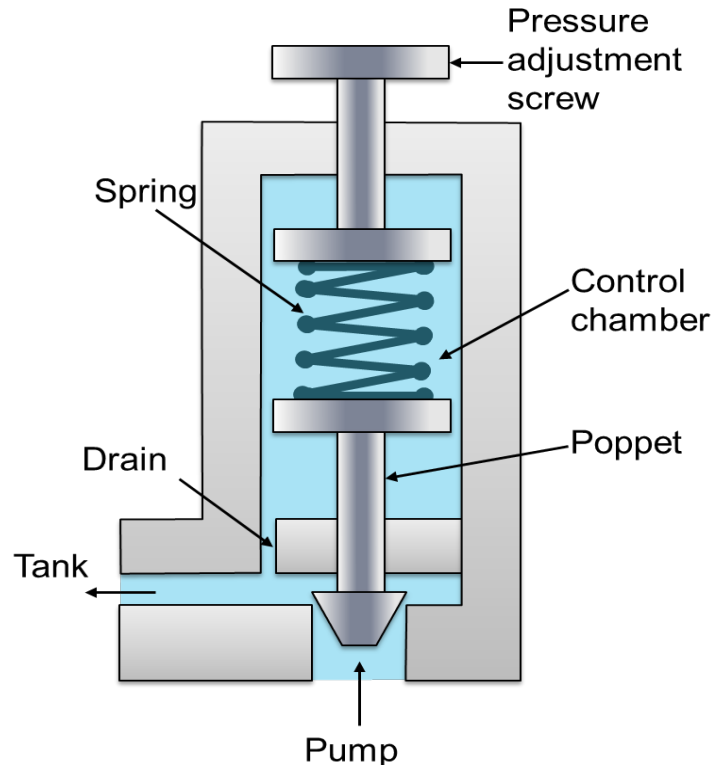


Figure 5.6.1 Pressure Relief Valve

Schematic of direct pressure relief valve is shown in figure 5.6.1. This type of valves has two ports; one of which is connected to the pump and another is connected to the tank. It consists of a spring chamber where poppet is placed with a spring force. Generally, the spring is adjustable to set the maximum pressure limit of the system. The poppet is held in position by combined effect of spring force and dead weight of spool. As the pressure exceeds this combined force, the poppet raises and excess fluid bypassed to the reservoir (tank). The poppet again reseats as the pressure drops below the pre-set value. A drain is also provided in the control chamber. It sends the fluid collected due to small leakage to the tank and thereby prevents the failure of the valve.

2. Unloading Valve

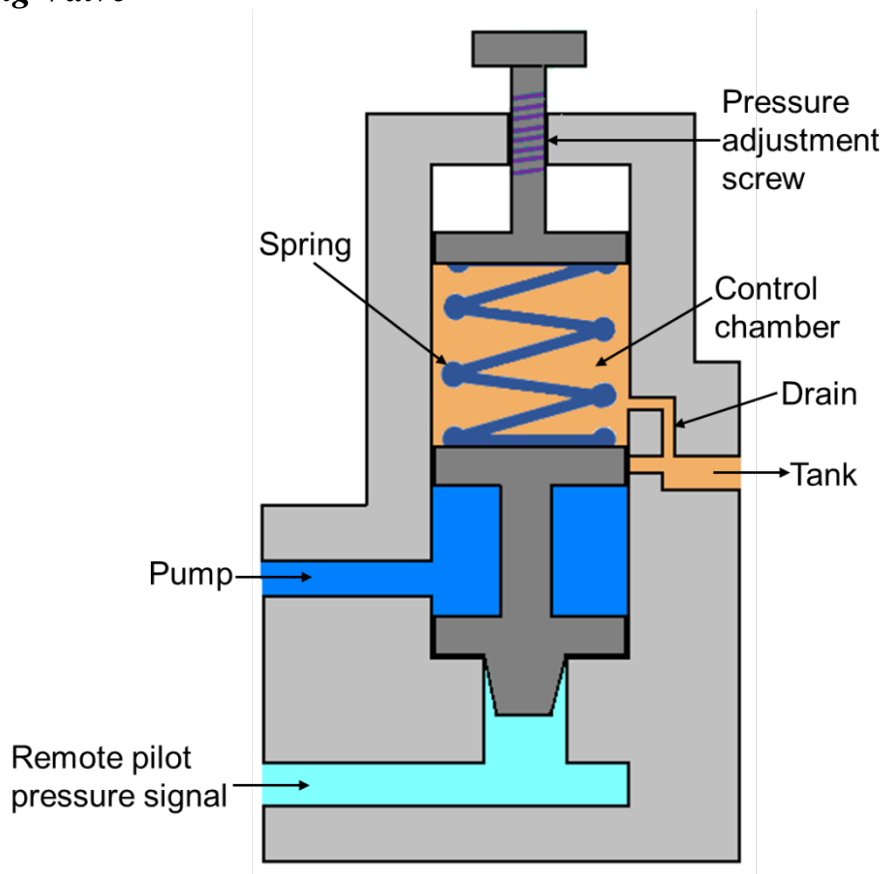


Figure 5.6.2 Unloading Valve

The construction of unloading valve is shown in Figure 5.6.2. This valve consists of a control chamber with an adjustable spring which pushes the spool down. The valve has two ports: one is connected to the tank and another is connected to the pump. The valve is operated by movement of the spool. Normally, the valve is closed and the tank port is also closed. These valves are used to permit a pump to operate at the minimum load. It works on the same principle as direct control valve that the pump delivery is diverted to the tank when sufficient pilot pressure is applied to move the spool. The pilot pressure maintains a static pressure to hold the valve opened. The pilot pressure holds the valve until the pump delivery is needed in the system. As the pressure is needed in the

hydraulic circuit; the pilot pressure is relaxed and the spool moves down due to the self-weight and the spring force. Now, the flow is diverted to the hydraulic circuit. The drain is provided to remove the leaked oil collected in the control chamber to prevent the valve failure. The unloading valve reduces the heat buildup due to fluid discharge at a preset pressure value.

3. Sequence valve

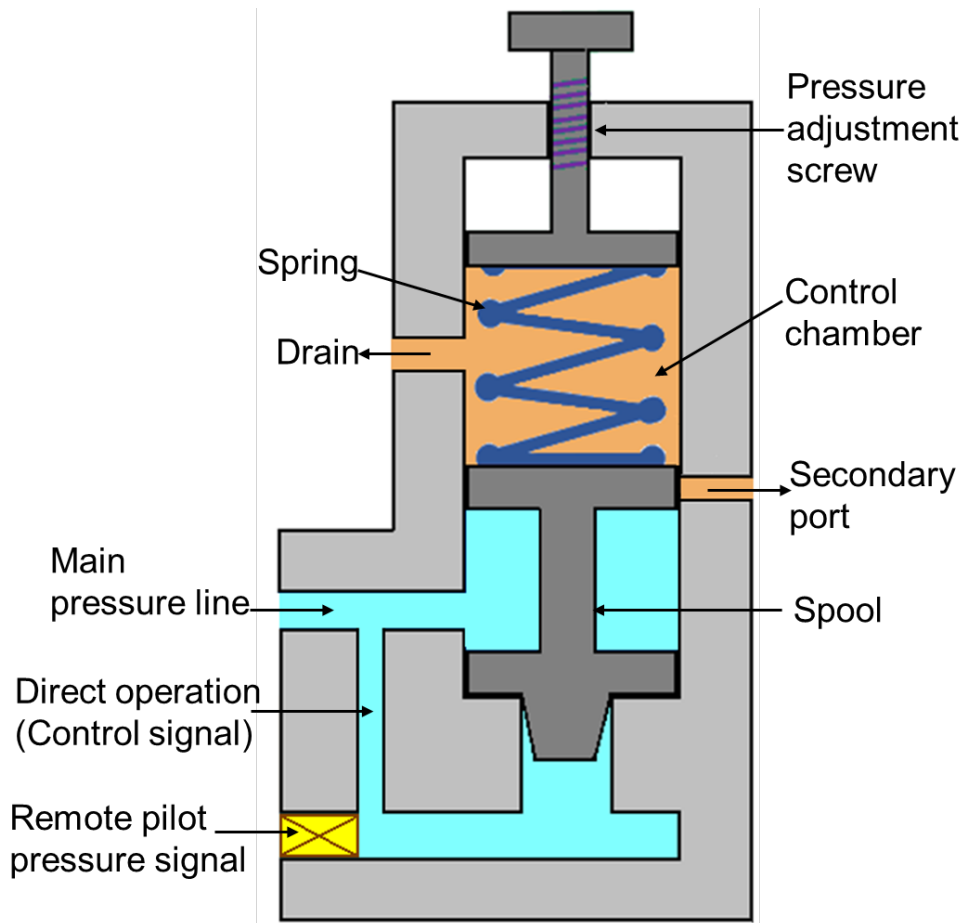


Figure 5.6.3 Sequence valve

The primary function of this type of valve is to divert flow in a predetermined sequence. It is used to operate the cycle of a machine automatically. A sequence valve may be of direct-pilot or remote-pilot operated type.

Schematic of the sequence valve is shown in Figure 5.6.3. Its construction is similar to the direct relief valve. It consists of the two ports; one main port connecting the main pressure line and another port (secondary port) is connected to the secondary circuit. The secondary port is usually closed by the spool. The pressure on the spool works against the spring force. When the pressure exceeds the preset value of the spring; the spool lifts and the fluid flows from the primary port to the secondary port. For remote

operation; the passage used for the direct operation is closed and a separate pressure source for the spool operation is provided in the remote operation mode.

4. Counterbalance Valve

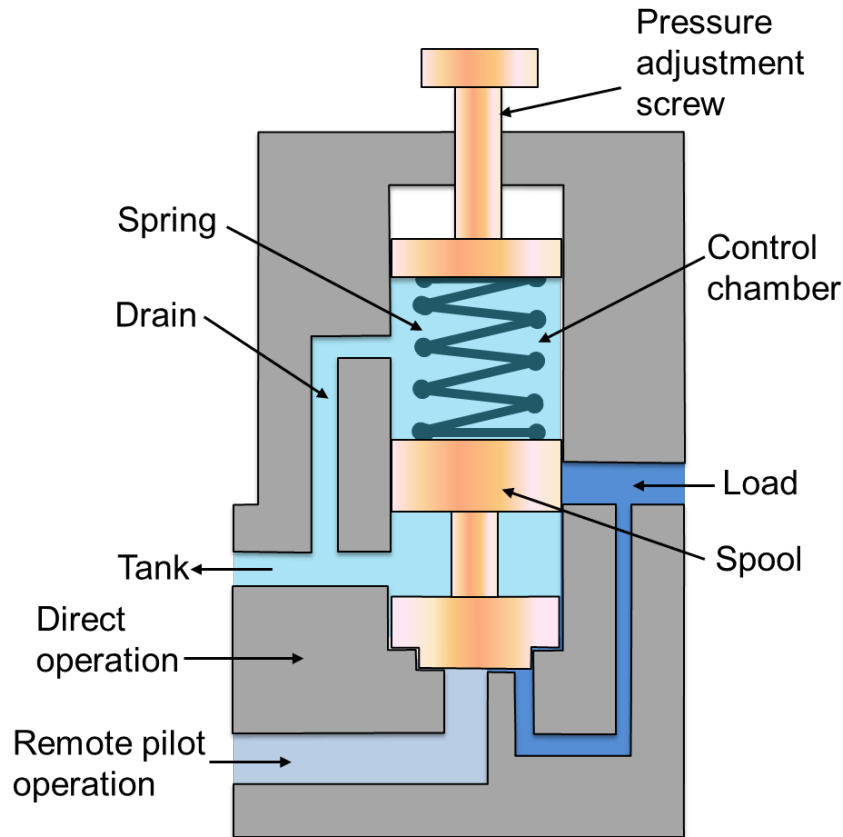


Figure 5.6.4 Counter Balance Valve

The schematic of counterbalance valve is shown in Figure 5.6.4. It is used to maintain the back pressure and to prevent a load from failing. The counterbalance valves can be used as breaking valves for decelerating heavy loads. These valves are used in vertical presses, lift trucks, loaders and other machine tools where position or hold suspended loads are important. Counterbalance valves work on the principle that the fluid is trapped under pressure until pilot pressure overcomes the pre-set value of spring force. Fluid is then allowed to escape, letting the load to descend under control. This valve is normally closed until it is acted upon by a remote pilot pressure source. Therefore, a lower spring force is sufficient. It leads to the valve operation at the lower pilot pressure and hence the power consumption reduces, pump life increases and the fluid temperature decreases.

5. Pressure Reducing Valve

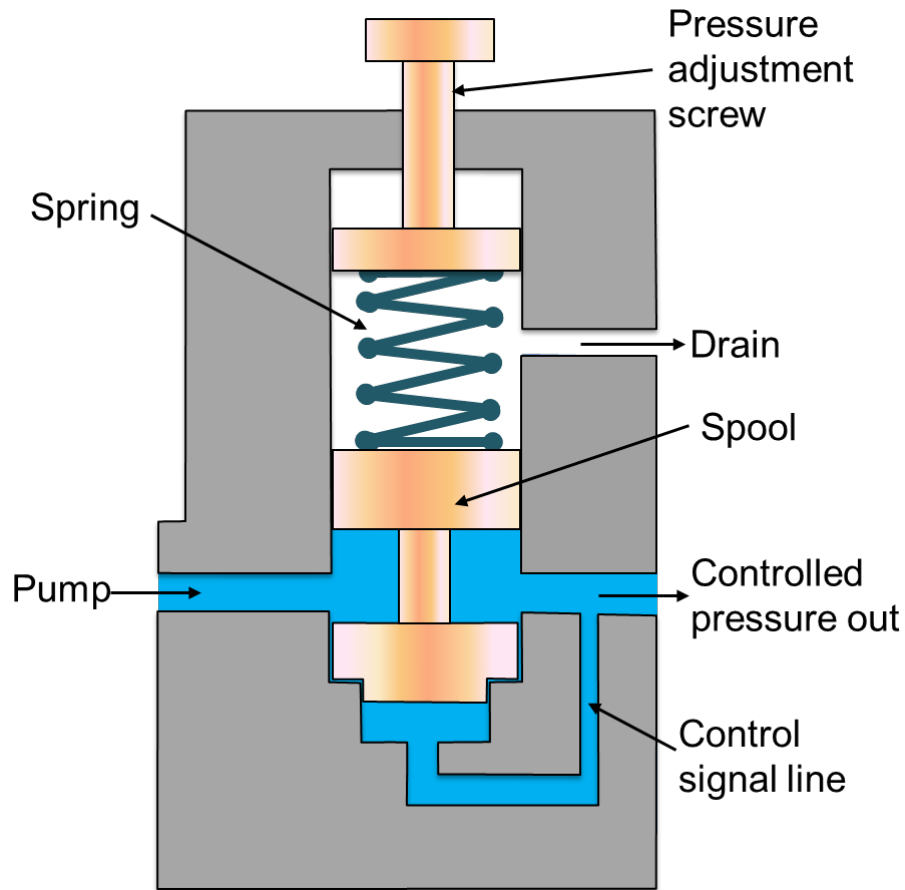


Figure 5.6.5 Pressure Reducing Valve

Sometimes a part of the system may need a lower pressure. This can be made possible by using pressure reducing valve as shown in Figure 5.6.5. These valves are used to limit the outlet pressure. Generally, they are used for the operation of branch circuits where the pressure may vary from the main hydraulic pressure lines. These are open type valve and have a spring chamber with an adjustable spring, a movable spool as shown in figure. A drain is provided to return the leaked fluid in the spring (control) chamber. A free flow passage is provided from inlet port to the outlet port until a signal from the outlet port tends to throttle the passage through the valve. The pilot pressure opposes the spring force and when both are balanced, the downstream is controlled at the pressure setting. When the pressure in the reduced pressure line exceeds the valve setting, the spool moves to reduce the flow passage area by compressing the spring. It can be seen from the figure that if the spring force is more, the valve opens wider and if the controlled pressure has greater force, the valves moves towards the spring and throttles the flow.

Module 5: Hydraulic systems

Lecture 7

Graphical representation of hydraulic and pneumatic elements

The hydraulic and pneumatic elements such as cylinders and valves are connected through pipelines to form a hydraulic or a pneumatic circuit. It is difficult to represent the complex functioning of these elements using sketches. Therefore graphical symbols are used to indicate these elements. The symbols only specify the function of the element without indicating the design of the element. Symbols also indicate the actuation method, direction of flow of air and designation of the ports. Symbols are described in various documents like DIN24300, BS2917, ISO1219 and the new ISO5599, CETOP RP3 and the original American JIC and ANSI symbols.

The symbol used to represent an individual element display the following characteristics:

- Function
- Actuation and return actuation methods
- Number of connections
- Number of switching positions
- General operating principle
- Simplified representation of the flow path

The symbol does not represent the following characteristics:

- Size or dimensions of the component
- Particular manufacturer, methods of construction or costs
- Operation of the ports
- Any physical details of the elements
- Any unions or connections other than junctions

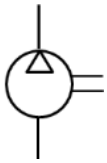
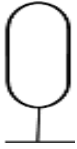
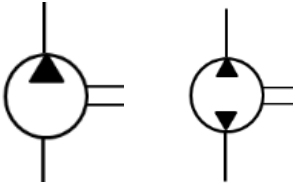
Earlier the ports were designated with letter system. Now as per ISO5599 the ports are designated based on number system. The port designations are shown in table 5.7.1

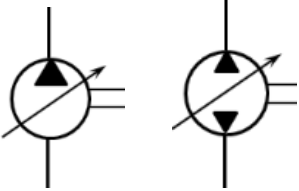
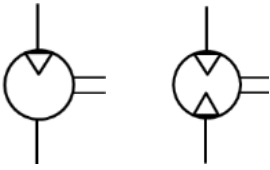
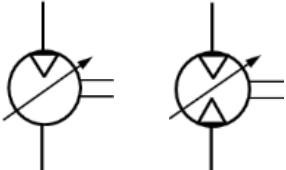
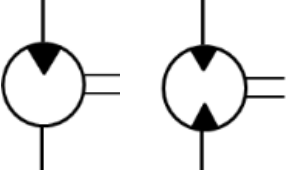
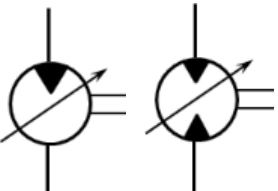
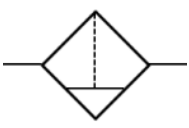
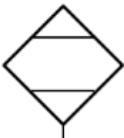
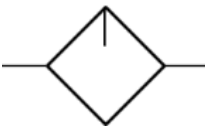
Table 5.7.1 Symbols for ports

Port	Letter system	Number system
Pressure port	P	1
Working port	A	4
Working port	B	2
Exhaust port	R	5
Exhaust port	S	3
Pilot port	Z	14
Pilot port	Y	12

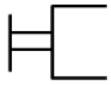
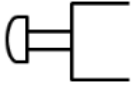


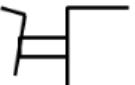
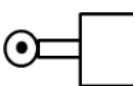
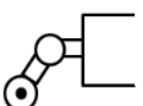

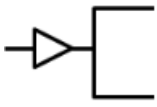


The graphical representation, designation and explanation of various components and equipments used in hydraulic and pneumatic system are given in table 5.7.2. Readers are suggested to study these representations carefully.

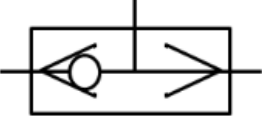
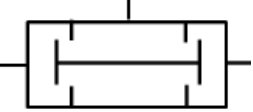
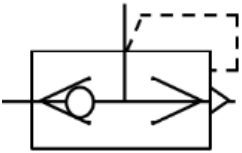

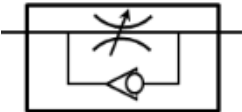
Table 5.7.2 Graphical symbols of hydraulic / pneumatic elements and equipments

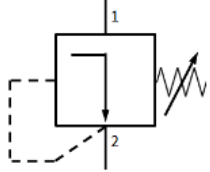
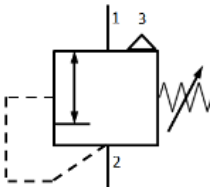
SYMBOL	DESIGNATION	EXPLANATION
Energy supply		
	Air compressor	One direction of rotation only with constant displacement volume
	Air receiver	Compressed air from the compressor is stored and diverted to the system when required
		One direction and two direction of rotation with constant displacement volume

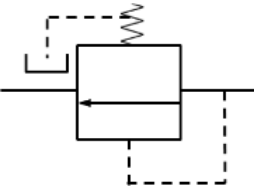
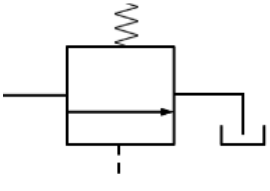
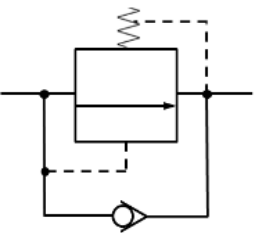
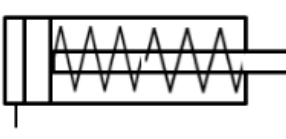
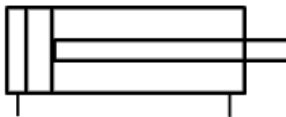
	<p>Hydraulic pump</p>	<p>One direction and two direction of rotation with variable displacement</p>
<p>Rotary actuators</p>		
	<p>Pneumatic motor</p>	<p>One direction and two direction of rotation with constant displacement volume</p>
		<p>One direction and two direction of rotation with variable displacement</p>
	<p>Hydraulic motor</p>	<p>One direction and two direction of rotation with constant displacement volume</p>
		<p>One direction and two direction of rotation with variable displacement</p>
<p>Service units</p>		
	<p>Air filter</p>	<p>This device is a combination of filter and water separator</p>
	<p>Dryer</p>	<p>For drying the air</p>
	<p>Lubricator</p>	<p>For lubrication of connected devices, small amount of oil is added to</p>

		the air flowing through this device
	Regulator	To regulate the air pressure
	FRL unit	Combined filter, regulator and lubricator system
Direction control valves (DCVs)		
	2/2 way valve	Two closed ports in the closed neutral position and flow during actuated position
	3/2 way valve	In the first position flow takes place to the cylinder In the second position flow takes out of the cylinder to the exhaust (Single acting cylinder)
	4/2 way valve	For double acting cylinder all the ports are open
	4/3 way valve	Two open positions and one closed neutral position
	5/2 way valve	Two open positions with two exhaust ports

Direction control valve actuation methods		
	General manual actuation	Manual operation of DCV
	Push button actuation	
	Lever actuation	
	Detent lever actuation	
	Foot pedal actuation	Mechanical actuation of DCV
	Roller lever actuation	
	Idle return roller actuation	
	Spring actuation	
	Direct pneumatic actuation	Pneumatic actuation of DCV
Non return valves		
	Check valve	Allows flow in one direction and blocks flow in other direction
	Spring loaded check valve	

	<p>Shuttle/ OR valve</p>	<p>When any one of the input is given the output is produced</p>
	<p>AND valve</p>	<p>Only when both the inputs are given output is produced</p>
	<p>Quick exhaust valve</p>	<p>For quick exhaust of air to cause rapid extension/retraction of cylinder</p>
<p>Flow control valves</p>		
	<p>Flow control valve</p>	<p>To allow controlled flow</p>
	<p>Flow control valve with one way adjustment</p>	<p>To allow controlled flow in one direction and free flow in other</p>

<p>Pressure control valves</p>		
	<p>Pressure relieving valve</p>	<p>Non relieving type</p>
		<p>Relieving type with overload being vented out</p>

	<p>Pressure reducing valve</p>	<p>Maintains the reduced pressure at specified location in hydraulic system</p>
	<p>Unloading valve</p>	<p>Allows pump to build pressure to an adjustable pressure setting and then allow it to be discharged to tank</p>
	<p>Counter balance valve</p>	<p>Controls the movement of vertical hydraulic cylinder and prevents its descend due to external load weight</p>
<p>Actuators</p>		
	<p>Single acting cylinder</p>	<p>Spring loaded cylinder with retraction taking place by spring force</p>
	<p>Double acting cylinder</p>	<p>Both extension and retraction by pneumatic/hydraulic force</p>

Module 5: Hydraulic systems

Lecture 8

Design of Hydraulic Circuit

Case study 1

1.1 Problem Definition: Package lifting device

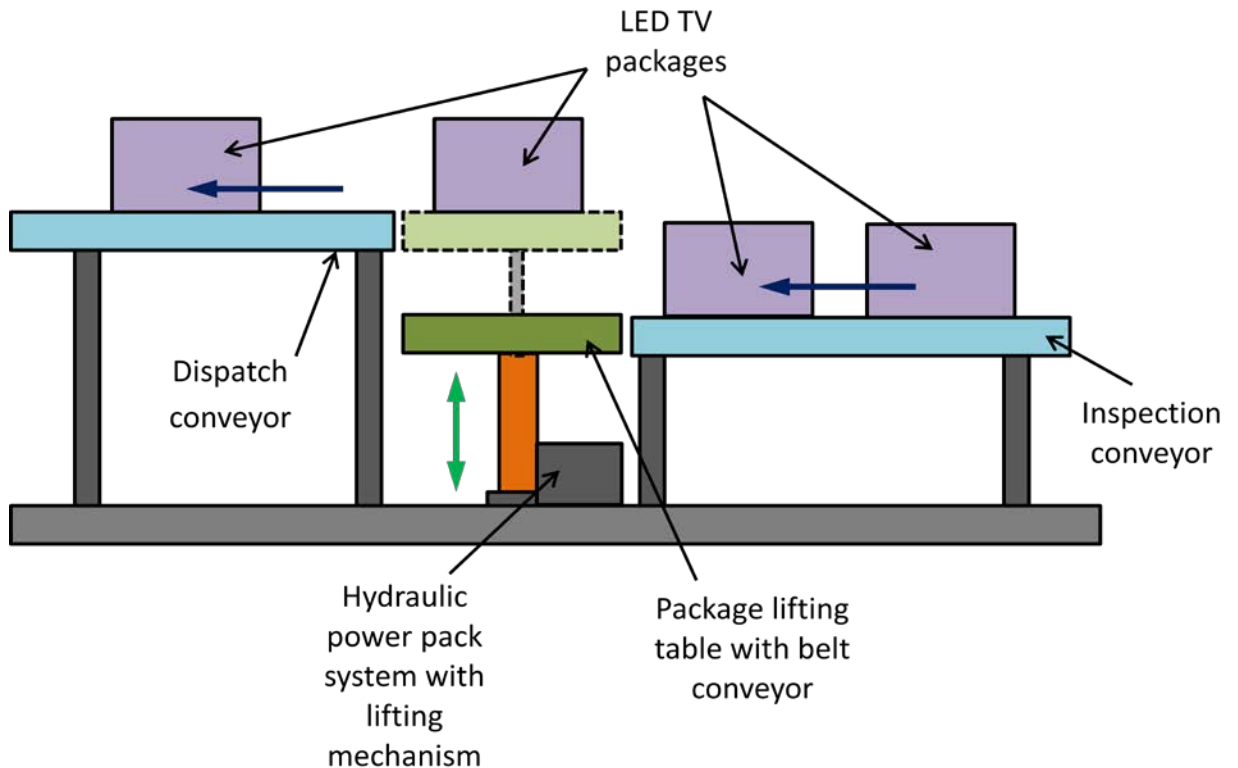


Figure 5.8.1 Schematic of a Package lifting system for LED TVs

For a dispatch station of a LED TV production house, design a package lifting device to lift packages containing 21” to 51” LED TVs from the inspection conveyor to the dispatch conveyor. Draw the hydraulic circuit diagram. List the components. Readers are requested to assume suitable data.

1.2Solution

By applying the principle of hydraulics and after studying the various sensors, pumps, valves and hydraulic actuators, the proposed hydraulic circuit is shown in Figure 5.8.1. Components required are listed in table 5.8.1.

Table 5.8.1 List of Components

S. No.	Item No.	Quantity	Description
1	1A	1	Two direction Hydraulic Motor with constant displacement volume
2	0Z1	1	Hydraulic Power Pack
3	0Z2	1	Pressure gauge
4	1V1	1	Shut-off valve
5	1V2	1	Pressure relief valve
6	1S	1	Flow sensor
7		5	Hose line
8		2	Branch tee

1.3 Proposed hydraulic circuit and its operation

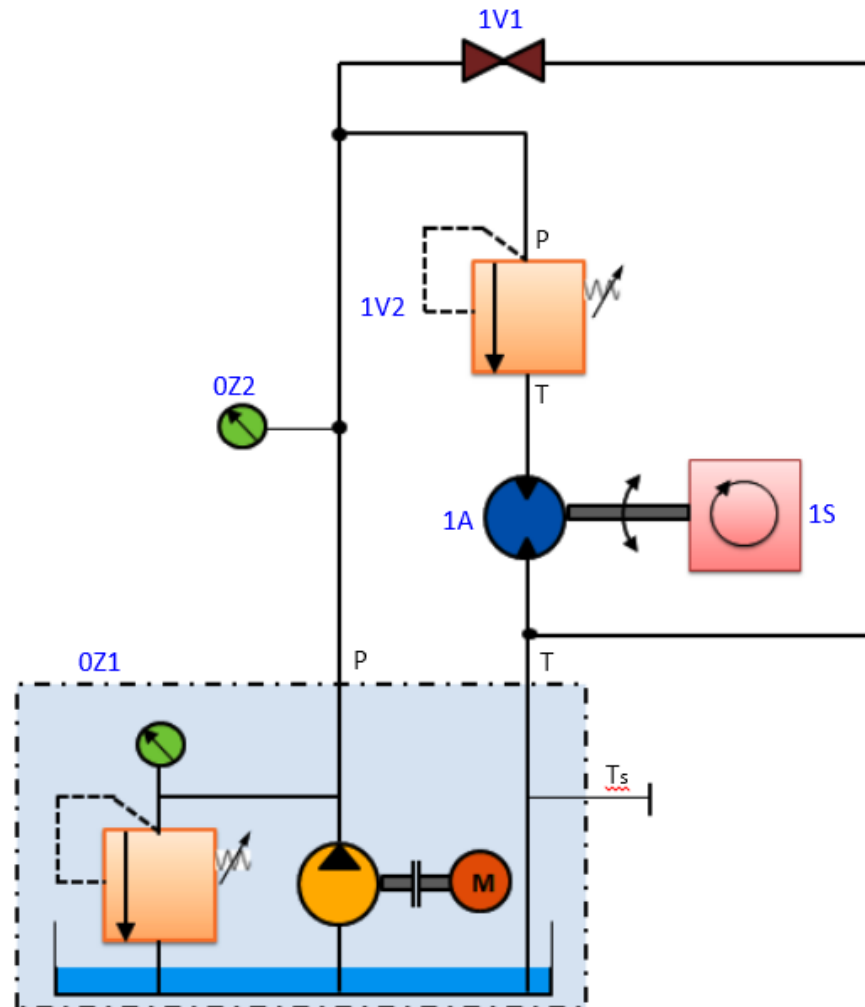


Figure 5.8.2 Hydraulic circuit design for package lifting device

Figure 5.8.2 shows the circuit design for package lifting device. The two direction hydraulic motor is run by using a hydraulic power pack. Required valves and pressure sensors are also included for desired control action. Readers are requested to carefully read the circuit and comprehend the circuit.

Once the hydraulic circuit has been assembled and checked, valve 1V1 and pressure relief valve 1V2 can be operated in sequence to obtain the rotary motion of hydraulic motor in required direction (clockwise/counter clockwise). This rotary motion can further be converted into linear motion by using suitable motion converter mechanism viz. Rack and pinion mechanism. Linear motion is used to lift the packages. It is required to develop a PID based controller to control the operation of the valves. The pressure gauge and flow sensor are used to monitor the operation continuously.

Case Study 2

2.1 Problem Definition: Furnace door control

Design a hydraulic circuit for a furnace door to be opened and closed. Figure 5.8.3 shows the schematic of the furnace and its door that to be controlled. Propose a suitable hydraulic technology. List the components. Draw the hydraulic circuit diagram. Compute stroke speeds and stroke times by assuming suitable data.

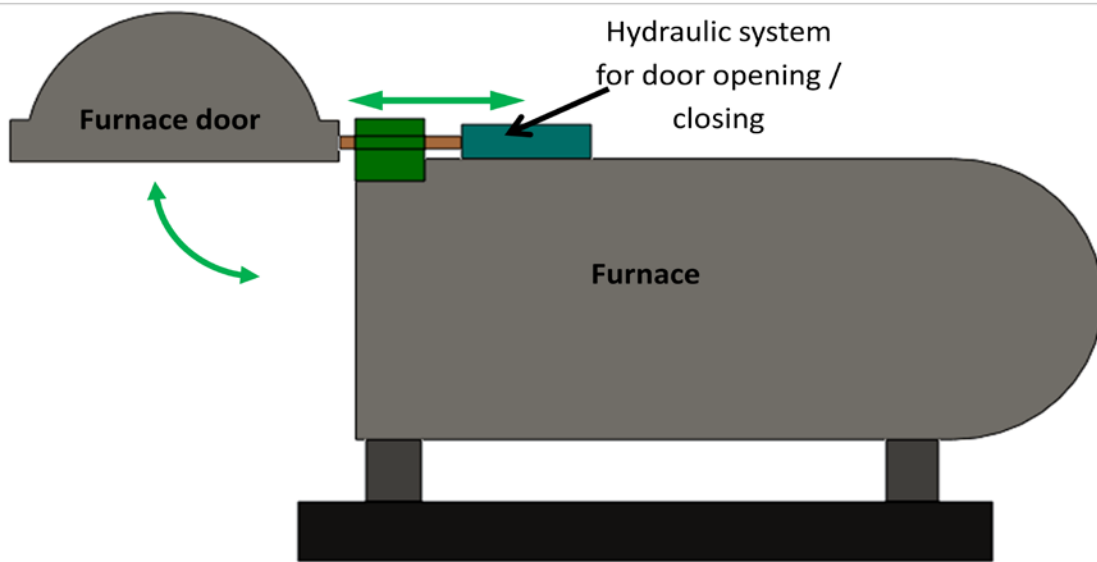


Figure 5.8.3 Furnace and its door

2.2 Solution

A double-acting cylinder can be used to control the movements of furnace door. The cylinder is to be activated by a 4/2-way valve with spring return. This will ensure that the door opens only as long as the valve is actuated. When the valve actuating lever is released, the door closes again. Table 5.8.2 lists the required hydraulic and mechanical components. Figure 5.8.4 shows the proposed hydraulic circuit.

Table 5.8.2 List of components

S. No.	Item No.	Quantity	Description
1	0Z1	1	Hydraulic Power Pack
2	0Z2	1	Pressure gauge
3	1S1, 1S2	2	Pressure sensor
4	0V	1	Pressure relief valve
5	1V	1	4/2 way valve, manually operated
6	1A	1	Cylinder
7		6	Hose line
8		2	Branch tee
9		1	Stop watch

2.3 Calculations

Let us assume the following data that required for the calculations:

Piston area, $A_{PN} = 200 \text{ mm}^2$

Piston annular area, $A_{PR} = 120 \text{ mm}^2$

Stroke length, $S = 200 \text{ mm}$

Pump output, $Q = 3.333 \times 10^4 \text{ mm}^3/\text{sec}$

Now,

$$\text{Area ration, } \alpha = \frac{A_{PN}}{A_{PR}} = 1.667$$

$$\text{Advance-stroke speed, } V_{adv} = \frac{Q}{A_{PN}} = 166.665 \text{ mm/sec}$$

$$\text{Return stroke speed, } V_{ret} = \frac{Q}{A_{PR}} = 277.775 \text{ mm/sec}$$

$$\text{Advance-stroke time, } T_{adv} = \frac{S}{V_{adv}} = 1.2 \text{ sec}$$

$$\text{Return-stroke time, } T_{ret} = \frac{S}{V_{ret}} = 0.72 \text{ sec}$$

$$\text{Travel speed ration, } \frac{V_{adv}}{V_{ret}} = 0.6$$

$$\text{Travel time ratio, } \frac{T_{adv}}{T_{ret}} = 1.667$$

2.4 Proposed hydraulic circuit and its operation

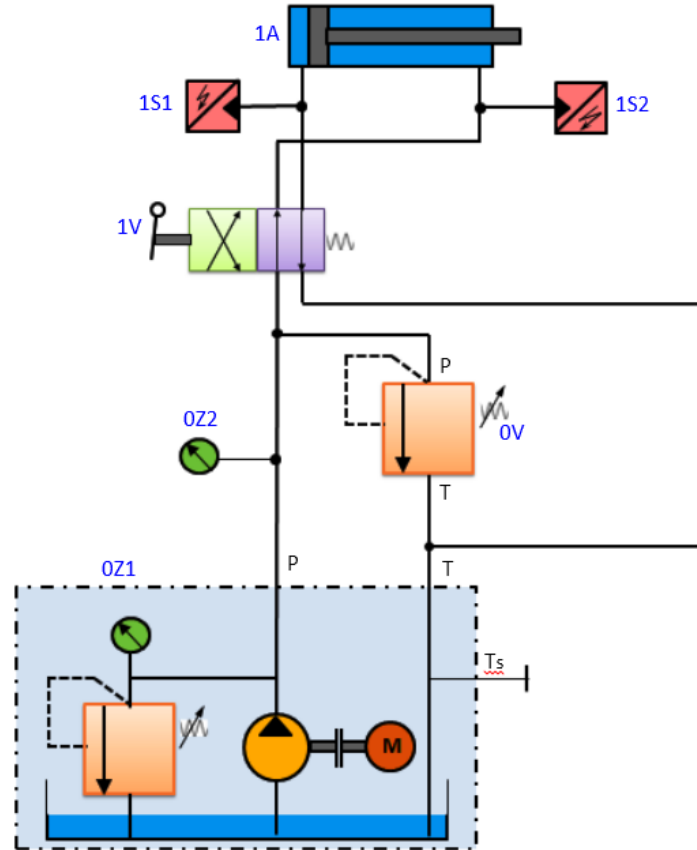


Figure 5.8.4 Hydraulic circuit for furnace door control

Figure 5.8.4 shows the hydraulic circuit for furnace door control. Once the circuit has been assembled and checked, the hydraulic power pack should be switched on and the system pressure set on the pressure relief valve 0V to a pre-set value. By operating the hand lever of valve 1V the opening and closing of the furnace can easily be carried out. When this 4/2-way valve is actuated, the piston rod of the cylinder will advance until the lever is released or the piston rod runs against the stop. When the lever is released, the piston rod will immediately return to its retracted end position. The hand lever can also be remotely operated by using suitable mechanism. Pressure sensors should be used to measure the travel and back pressures.