

Water treatment

Sustainable technology for environmental protection



Table of contents

Introduction

Basic knowledge Wastewater treatment plant	04
--	----

Unit operations of water treatment

Mechanical processes

Basic knowledge Mechanical water treatment	06
HM 142 Separation in sedimentation tanks	08
CE 587 Dissolved air flotation	10
CE 588 Demonstration of dissolved air flotation	12
CE 579 Depth filtration	14

Biological processes

Basic knowledge Biological water treatment	16
CE 705 Activated sludge process	18
CE 704 SBR process	20
CE 701 Biofilm process	22
CE 730 Airlift reactor	24
CE 702 Anaerobic water treatment	28

Physical/chemical processes

Basic knowledge Physical/chemical water treatment	30
CE 583 Adsorption	34
CE 530 Reverse osmosis	36
CE 300 Ion exchange	37
CE 586 Precipitation and flocculation	38
CE 584 Advanced oxidation	40

The area of water focuses on water treatment. The aim of water treatment is always to remove specific substances from the water. This can be used to clean wastewater in a wastewater treatment plant prior to discharge into a body of water. From the perspective of environmental protection, the remediation of contaminated groundwater and landfill leachate is another broad application example. However, the aim of water treatment may also be to make water usable for a particular purpose, e.g. in the treatment of potable water.

Regardless of the application, there are a number of basic methods available to water treatment which are classically divided into three groups.

This section contains a teaching unit for each of the most important basic procedures, with which all important aspects of the respective method can be illustrated and taught in a clear and informative manner.

Water treatment plants are usually built in several stages and represent a combination of various basic processes. Therefore, we also offer two devices that enable you to illustrate the complexities of multistage water treatment.

Multistage water treatment

Combined unit operations

Basic knowledge Multistage water treatment	42
CE 581 Water treatment plant 1	44
CE 582 Water treatment plant 2	46



Basic knowledge Wastewater treatment plant

Environmental protection through wastewater treatment

If untreated wastewater is discharged into a body of water, microorganisms destroy the organic matter contained in the water through high oxygen consumption. This leads to a lack of oxygen in the water, which in turn destroys the ecological balance. To prevent this from happening, wastewater must be treated in wastewater treatment plants beforehand. The most important component of a wastewater treatment plant is the biological purification by microorganisms. The natural degradation processes are thus shifted from the body of water into an industrial plant, where they take place in controlled and optimised conditions.

Mechanical treatment

First the wastewater is treated mechanically. The aim is to remove solids from the water. A bar screen first removes coarse solids such as textiles, paper and plastic bags from the wastewater. Then mineral solids such as entrained sand are separated in grit chambers by sedimentation. Organic solids, such as food scraps, are also separated by sedimentation in the primary clarification.



Biological treatment

After the mechanical treatment, the wastewater contains almost exclusively dissolved substances. These dissolved substances are biodegraded by microorganisms in the biological treatment. The most commonly used method here is the aerobic activated sludge process. In this treatment stage, the wastewater is aerated in order to supply the microorganisms (activated sludge) with oxygen. Since the activated sludge is suspended in the aeration tank, activated sludge is also continuously discharged along with the wastewater flow. In the secondary clarifier the activated sludge is discharged mechanically separated (usually by sedimentation) from the treated water. A portion of the separated activated sludge is fed back into the aeration tank as return sludge. Without return sludge, it would not be possible to achieve stable operation of the biological treatment. Although the secondary clarifier is actually a mechanical process, it is still therefore classed as a biological treatment.

Sludge treatment

The non-recycled portion of the sludge separated in the secondary clarifier is referred to as surplus sludge or secondary sludge. Surplus sludge and sludge from the primary clarification (primary sludge) mainly contain organic ingredients and are a by-product of wastewater treatment. Therefore, a separate treatment is required for this sludge (sewage sludge). This is usually implemented in digestion towers, where the sewage sludge is digested under anaerobic conditions. Digested sludge can then be used as fertiliser in agriculture, for example.





Basic knowledge Mechanical water treatment

Solids can easily lead to blockages in plant components such as pipes, valves and fittings. In multistage water treatment plants the first stage is usually to remove solids by mechanical means for this reason. In mechanical processes, the solids are not altered either physically or chemically. Only separation of the solids from the liquid phase (water) takes place. This can be implemented according to the following three principles:

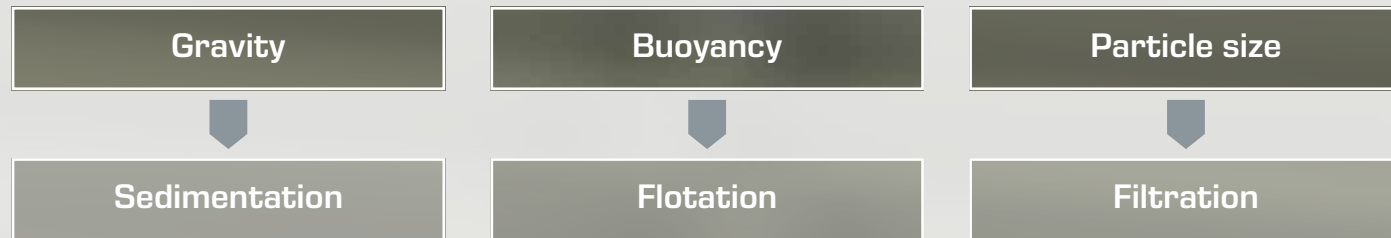

Sedimentation

The easiest way to separate solids is by sedimentation. In the sedimentation tank, the solid particles fall to the bottom due to gravity and can then easily be removed with sludge scrapers. Effective sedimentation requires calm flow conditions in the sedimentation tank (no turbulence). Sedimentation is mainly used in wastewater treatment plants in primary clarification and secondary clarification.

Filtration

During filtration, the solids are retained by porous filter media. Effective filtration requires that the filter medium is only permeable for the liquid phases (water), but not for the solids. The success of treatment depends on the particle size of the solids in relation to the pore size of the filter medium. A basic distinction is made between surface filtration and depth filtration.

In **surface filtration**, the solids do not penetrate the filter medium, but instead are retained on its surface (sieve effect). In **depth filtration**, however, the wastewater penetrates the filter medium (e.g. fixed bed of sand or gravel). The solids are retained in the pores between the individual sand grains, whereas the water flows through the fixed bed unimpeded (filtrate). As the load of the fixed bed increases, the pressure drop increases and the flow rate decreases. A backwash cleans the fixed bed again, so that the pressure drop decreases.

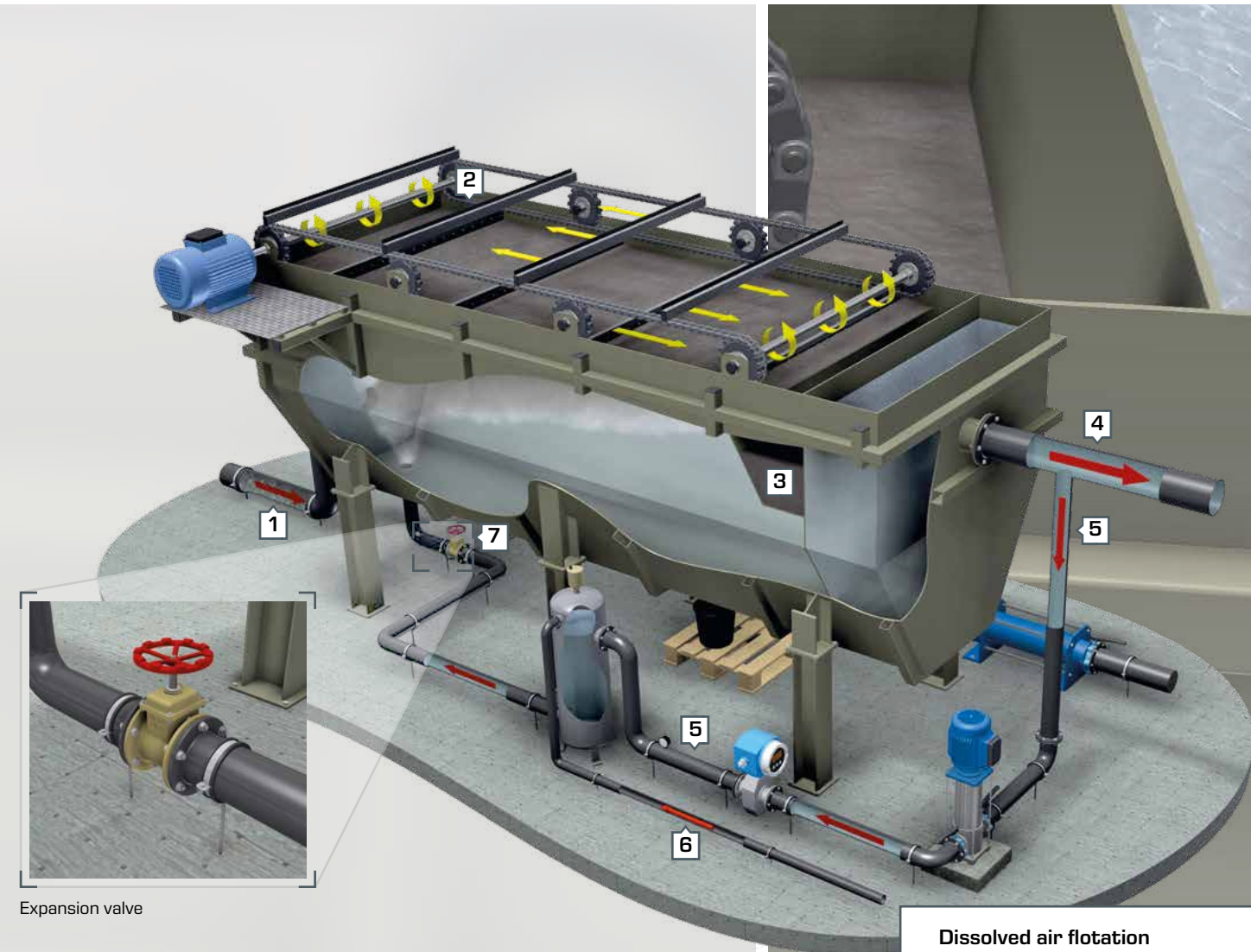
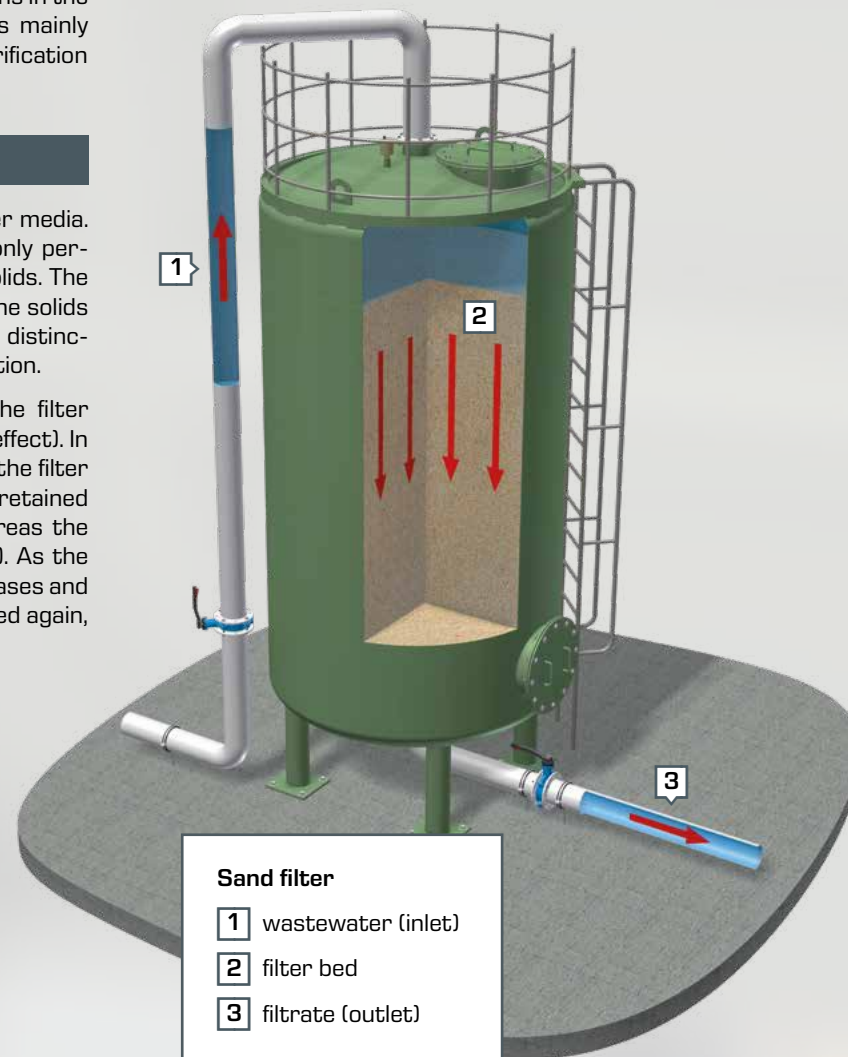

Flotation

Solids with low settling velocities cannot be effectively separated by sedimentation because this would require very large sedimentation tanks. In this case, flotation processes provide a sensible alternative. The basic principle is still the same. Gas bubbles attach themselves to the bottom of the solids and drive the solids to the surface. Once there, the floated solids can be removed with special scrapers. Flotation processes differ mainly in the way the gas bubbles are produced.

In water treatment, the most commonly used method is dissolved air flotation. In this process, a partial flow of the treated water is saturated with air under pressure. The air-saturated water is then passed back to the inlet region of the flotation tank (circulation). An expansion valve is located just before the inlet to the flotation tank, which causes the water to suddenly re-expand to atmospheric pressure. This expansion causes the dissolved air to form fine bubbles.

Dissolved air flotation

- 1 wastewater
- 2 sludge scraper
- 3 separated sludge
- 4 treated water
- 5 circulation
- 6 compressed air
- 7 expansion valve



HM 142

Separation in sedimentation tanks

Sedimentation is the easiest way to separate solid particles from a liquid phase. Therefore this process is very common in water treatment. This device can be used to clearly teach the basics of this separation process. The main focus is on determining the maximum possible hydraulic surface loading.

We have placed great importance on visual observation of the sedimentation process. Therefore mainly transparent materials are used. Furthermore, the sedimentation tank is fitted with lighting.

The raw water is produced by mixing a concentrated suspension with fresh water. Depending on the mixing ratio, a raw water with the desired solids concentration is obtained. A stirring machine in the inlet area of the sedimentation tank prevents the solids from settling before entering the experiment section. The water level in the sedimentation tank can be adjusted continuously.

The device is completed by a lamella unit, which you can optionally place in the sedimentation tank. White and black lamellas are available, depending on the colour of the contaminants used.

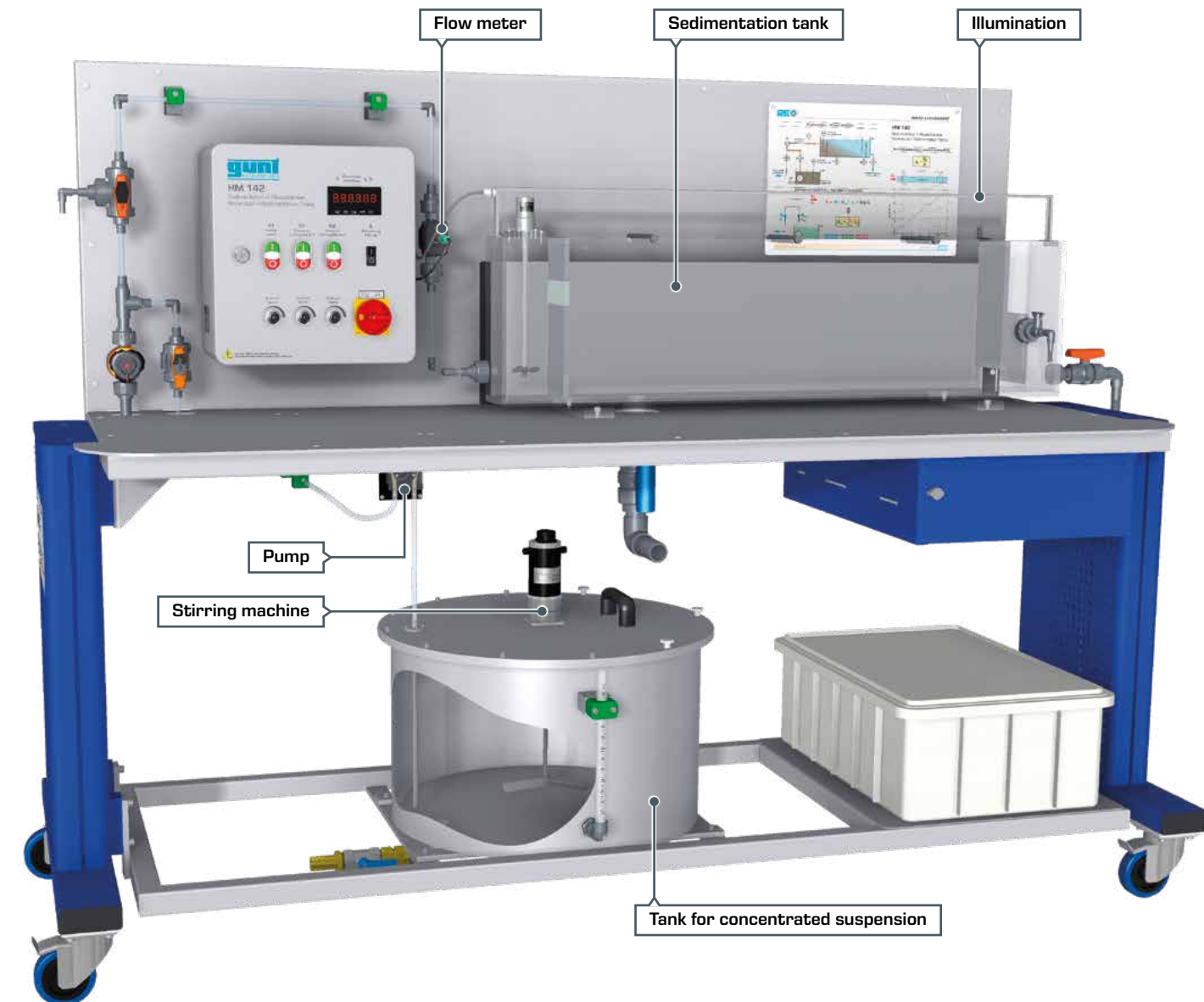

The sedimentation process and the flow conditions can be observed very clearly thanks to the use of transparent materials and lighting.



Optional lamella unit

About the product:



Learning objectives	
■	basic principle for the separation of solids from suspensions in a sedimentation tank
■	determine the hydraulic surface loading
■	influence of the following parameters on the separation process: <ul style="list-style-type: none"> ▶ concentration of solids ▶ flow rate ▶ flow velocity in the inlet ▶ water level in the sedimentation tank
■	investigation of the flow conditions
■	how lamellas affect the sedimentation process



CE 587

Dissolved air flotation

Removal of solids by flotation

Flotation, alongside sedimentation, is another process often used in water treatment to remove solids. Dissolved air flotation is the most commonly used flotation process.

Experiments with great practical relevance

Our CE 587 teaching unit allows you to study all important aspects of this process. In order to create high practical relevance, we have placed great emphasis on the highest possible realism in the development of this device.

The device consists of a supply unit and a trainer. First, the raw water is pre-treated by flocculation. Then the flocs are transported to the surface of the water in the flotation tank by means of small air bubbles. An electrically driven scraper allows you to clear the water surface of the floating substances. Many of the components used, such as electromagnetic flow rate sensors and metering pumps, are also used in large-scale industrial plants. By using transparent materials you can optimally observe all the stages in the process.

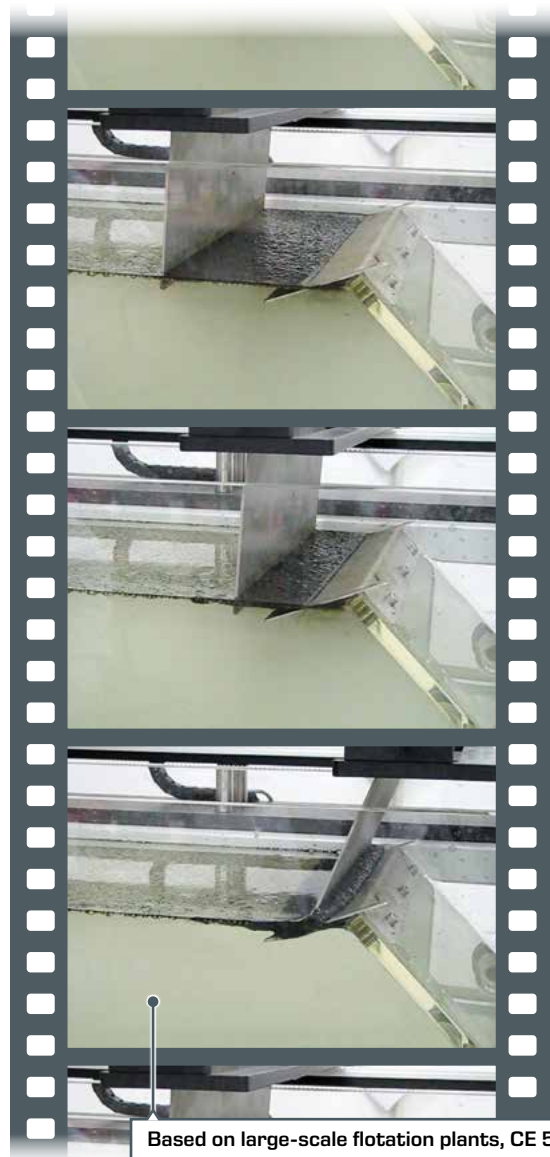

Based on large-scale flotation plants, CE 587 is equipped with an electrically driven scraper which removes the floated solids from the surface of the water.



Supply unit



Standard at GUNT: use of high-quality industrial components such as professional metering loading rate (rising velocity) pumps

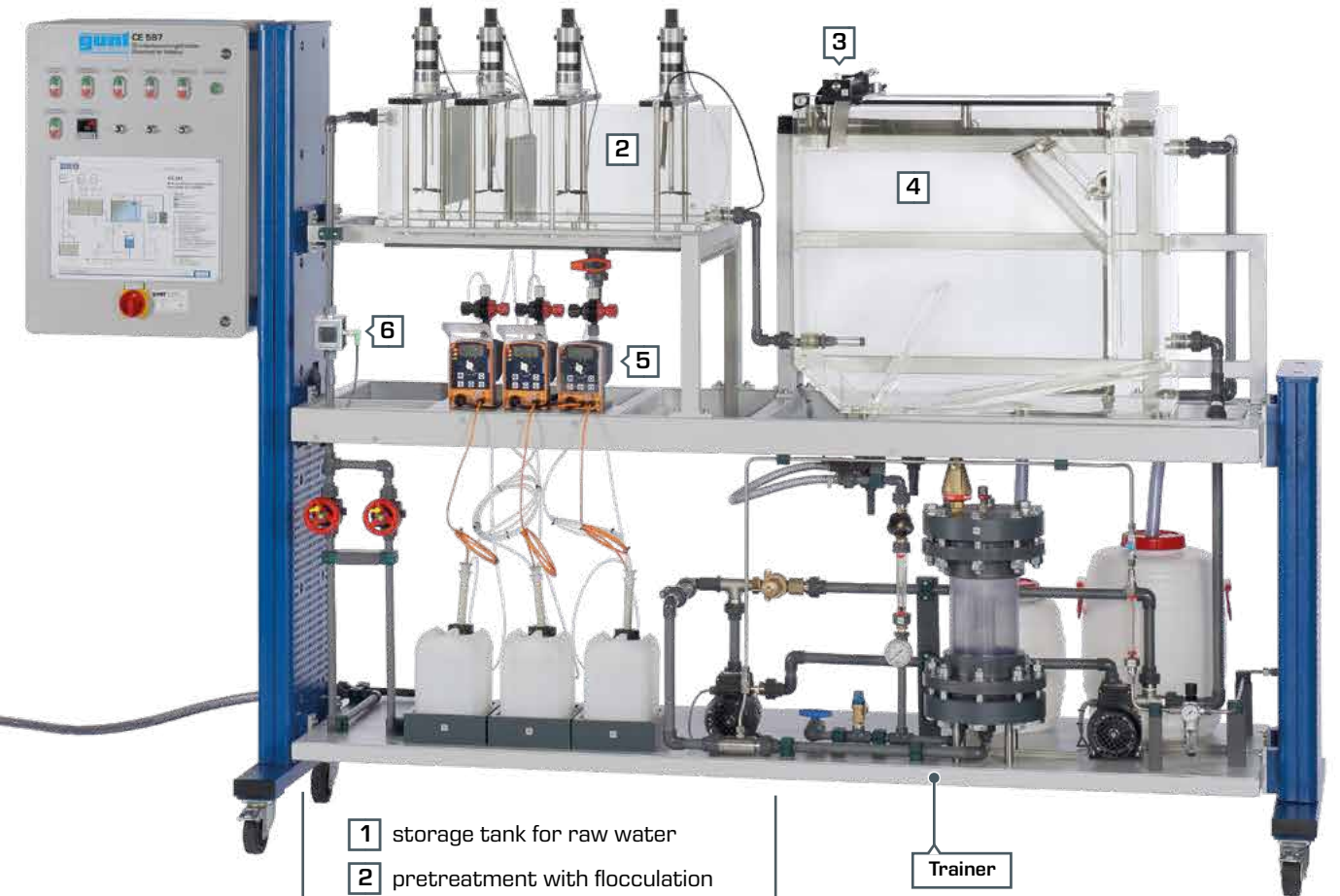

- 1 storage tank for raw water
- 2 pretreatment with flocculation
- 3 electrically driven scraper
- 4 flotation tank
- 5 metering pumps
- 6 electromagnetic flow meter

Trainer

Learning objectives	
■	functional principle of dissolved air flotation
■	creation of a stable operating state
■	effects of the coagulant and flocculant concentration
■	determination of the hydraulic loading rate (rising velocity)

About the product:





CE 588

Demonstration of dissolved air flotation

Dissolved air flotation clearly demonstrated

During flotation, the solids to be separated are transported to the water surface by small gas bubbles. The most commonly used process is the dissolved air flotation. The basis of this process is that the solubility of air in water increases with increasing pressure.

This compact trainer focuses on the basic function and visualisation of the process. Therefore, we have used transparent materials and attached great importance to easy-to-use components. Our CE 587 teaching system is also characterised by its practical relevance.

The undissolved contaminants are separated in a vertical flotation column. A water circuit is connected to the flotation column. At the highest point of the circulation there is negative pressure. The required air for the flotation is sucked in by opening a

valve located at this point. Under pressure, the air dissolves in the water and, after the water has been depressurised in the lower part of the flotation column, the air forms small bubbles. A pressure vessel filled with Pall rings ensures a sufficiently long retention time to dissolve the air and to separate undissolved air before entering the flotation column.

Of course you also receive comprehensive instructional material for this device that quickly helps you become familiar with operation.

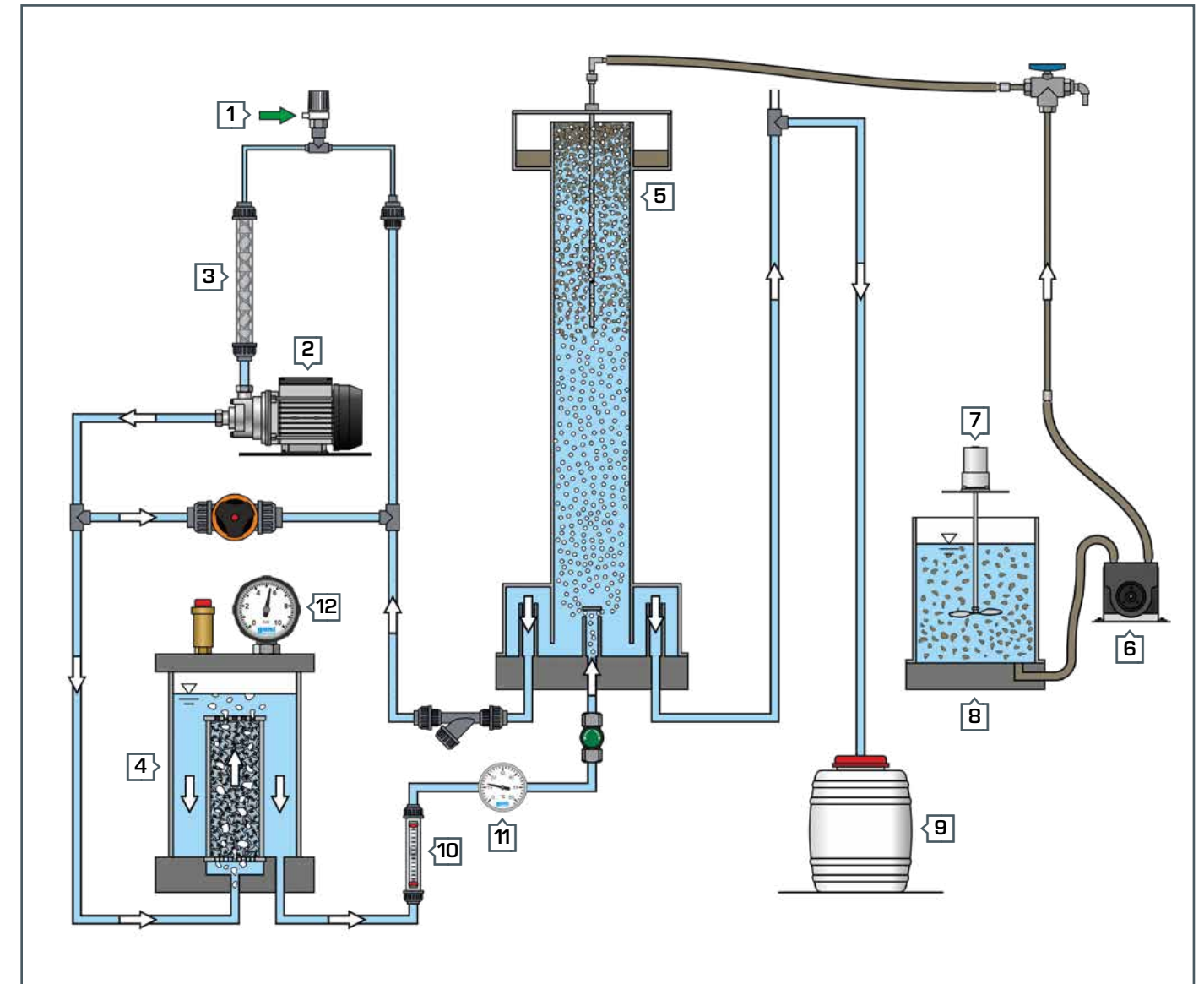
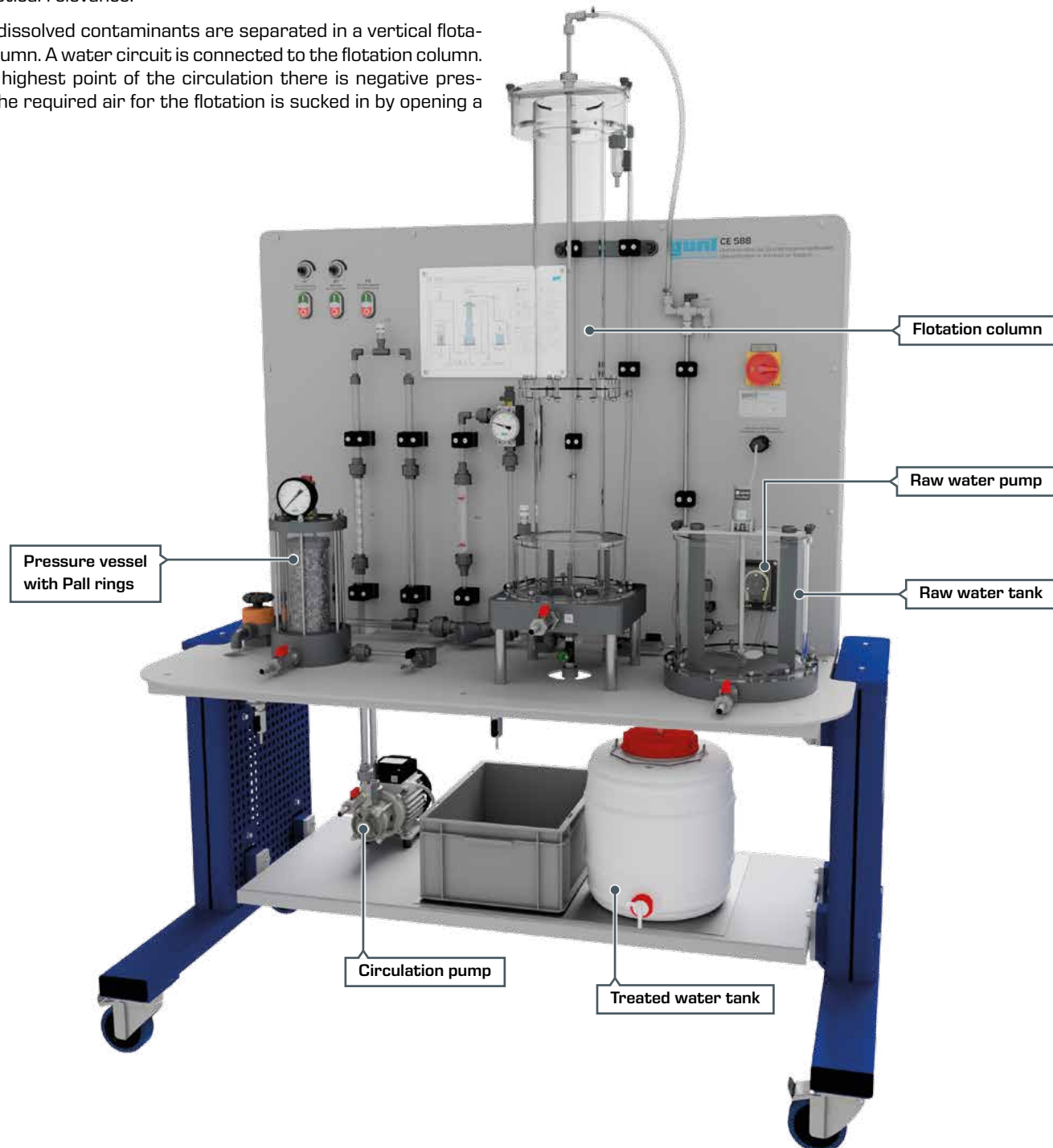

- | | |
|--------------------|----------------------|
| 1 air | 7 stirring machine |
| 2 circulation pump | 8 raw water tank |
| 3 static mixer | 9 treated water tank |
| 4 pressure vessel | 10 flow meter |
| 5 flotation column | 11 thermometer |
| 6 raw water pump | 12 manometer |

Learning objectives

- how dissolved air flotation works
- dissolving gases in liquids:
 - Henry's law
 - Dalton's law

About the product:





CE 579

Depth filtration

Depth filtration: indispensable in water treatment

Depth filtration is an important and frequently used process step in water treatment. Exact knowledge of the principle of operation and the characteristics of this process are an indispensable component in the education of budding engineers and specialist technicians.

The educational focus of this trainer is the investigation of the pressure conditions. In order to measure the pressures, the filter is fitted with a differential pressure measurement and a number of individual measuring points along the filter bed.

These measurement points can be connected to a manometer panel, enabling you to very accurately measure the pressure conditions in the filter bed. By using a transparent filter tube, you can also observe the increased loading of the filter bed visually. The filter can be backflushed if necessary.

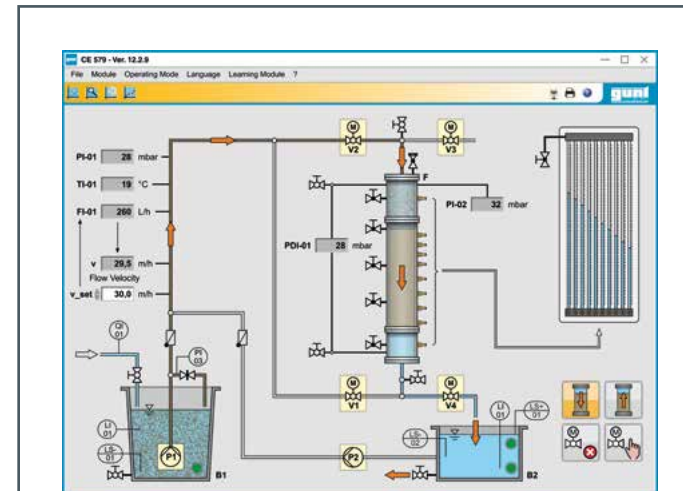

Software

The clearly-arranged software included with CE 579 continuously displays all key process variables. You can of course save the measured values for analysis. Depending on the selected operating mode (filtration or backwashing), the software moves electrically-driven valves to each corresponding position.

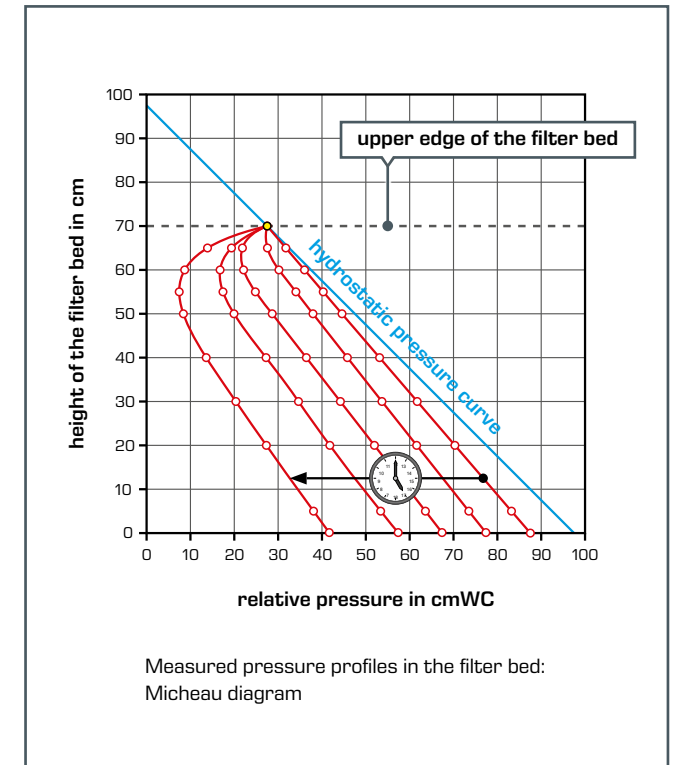

Electrically-driven ball valve



Frequency converters for controlling the pumps



Connections on the manometer panel for measuring the pressure in the filter bed

Learning objectives

- pressure conditions in a filter
- factors influencing the pressure loss (Darcy's law)
 - ▶ flow rate
 - ▶ height of the filter bed
 - ▶ permeability of the filter bed
- determine the pressure in the filter bed (Micheau diagram)
- backwash of filters
 - ▶ observe the fluidisation process
 - ▶ determine the expansion of the filter bed
 - ▶ determine the required flow velocity (fluidisation velocity)

About the product:





Basic knowledge Biological water treatment

Microorganisms clean wastewater

The aim of biological wastewater treatment is the elimination of organic, biodegradable materials. This elimination is carried out by microorganisms which use organic substances as a source of food. This biodegradation also causes a conversion of materials to take place. This is a significant advantage that biological processes have over other methods. In adsorption, for example, it is simply a matter of displacing the substances to be removed from the wastewater onto the adsorbent (mass transport). Biodegradation may occur under either aerobic or anaerobic conditions. A number of methods are available in order to bring the wastewater to be treated into contact with the microorganisms (biomass). Regardless of whether the degradation is carried out aerobically or anaerobically, a distinction is made between the following two principles:

Suspended biomass

The biomass is present in the form of small flocs (activated sludge). The activated sludge is suspended in the wastewater.

Sessile biomass

The biomass is fixed on surfaces of solid bodies as a biofilm. The wastewater runs away over the biofilm as a thin film.

Aerobic activated sludge process

The aerobic activated sludge process is the most widely used biological wastewater treatment process. The biomass is a suspended activated sludge in the aeration basin through which the wastewater flows continuously. The wastewater is also aerated here in order to supply the microorganisms with oxygen. Biomass (activated sludge) also continuously leaves the aeration tank along with the wastewater flow. Therefore, the discharged

activated sludge must be separated from the treated wastewater in a secondary clarifier (usually by sedimentation). Part of it is fed back into the aeration tank (return sludge). The non-recycled fraction is referred to as surplus sludge and is a waste product of this process.

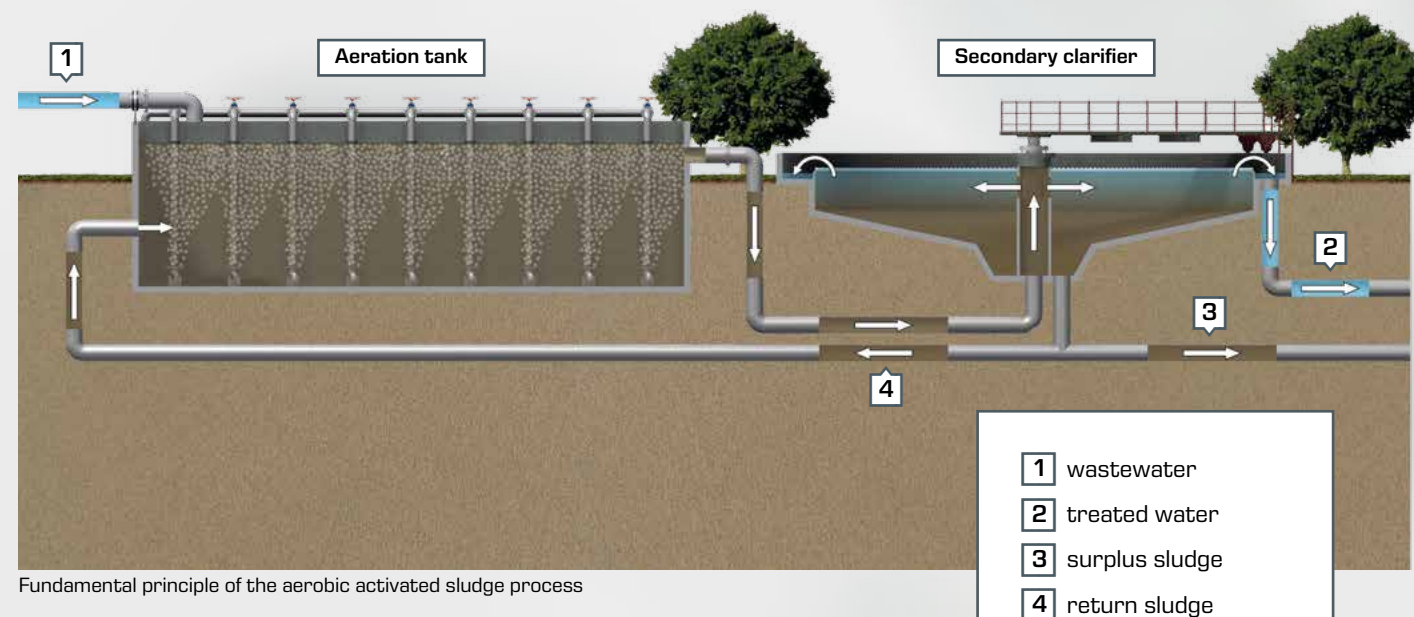

Fundamental principle of the aerobic activated sludge process

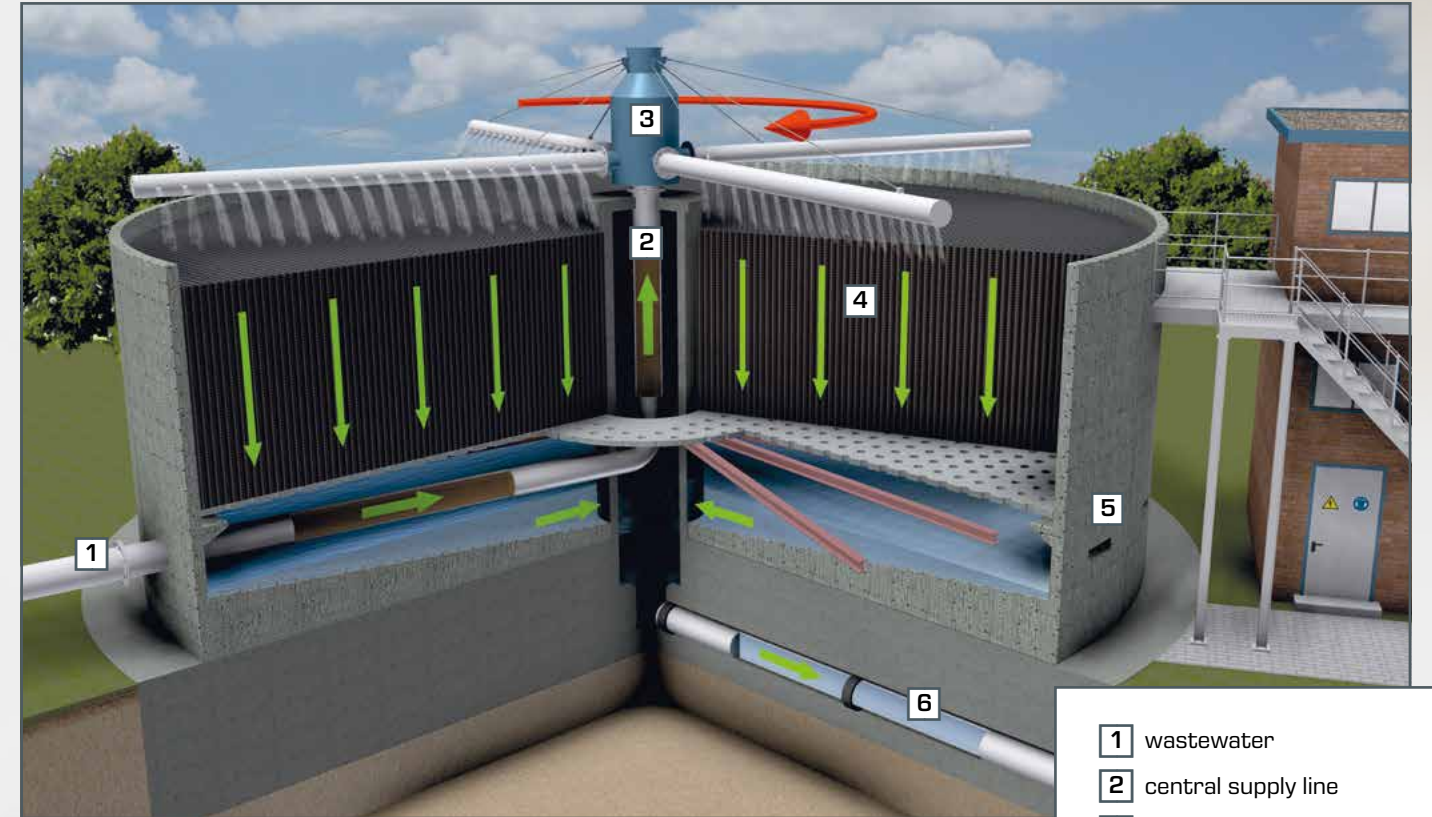

Design and function of a trickling filter

- 1 wastewater
- 2 central supply line
- 3 rotary distributor
- 4 fixed bed with biofilm
- 5 aeration openings
- 6 treated water

Trickling filters

Trickling filters are an aerobic biofilm process. In this process, a rotary sprinkler spreads the wastewater evenly over a fixed bed. The fixed bed consists of special support material on the surface of which a thin layer of microorganisms (biofilm) forms. While the wastewater trickles through the fixed bed, the microorganisms clean the wastewater by biological processes. Trickling filters usually have an open design and offer lateral openings below the fixed bed. This allows aeration by natural convection (chimney effect). Energy-intensive artificial aeration, such as that used in the activated sludge process, is not necessary.

Anaerobic processes

Anaerobic processes are particularly suitable for industrial wastewater, which is often heavily contaminated with organic substances (e.g. food industry). There is a variety of different processes or reactor types available for this purpose. Under anaerobic conditions, the degradation of organic matter creates biogas, which consists mainly of methane. Biogas can be used, for example, with combined heat and power plants to generate electricity. This is a positive secondary aspect of anaerobic wastewater treatment and clearly illustrates the close interconnection of issues from the field of energy and environment.



CE 705

Activated sludge process

A laboratory-scale wastewater treatment plant

The aerobic activated sludge process is the most widely-used biological process in wastewater treatment plants worldwide. Sound knowledge of this process is therefore essential for budding engineers and specialist technicians in the field of environmental engineering.

This device has been designed by experienced engineers with the aim of being able to clearly teach the complex processes involved in this process in continuous operation in a practical manner. The device is designed for carbon elimination and nitrogen elimination. The nitrogen is removed by nitrification and pre-denitrification. To this end, the aeration tank is divided into an aerobic and an anoxic area.

The device consists of a separate supply unit with a large storage tank for wastewater and a trainer. All process-relevant components are located on the trainer. This includes in particular the aeration tank and secondary clarifier.

You can adjust all process-relevant parameters in order to investigate their influence on the cleaning process. The control of the trainer is realised by the integrated PLC via touch screen. By means of an integrated router, the trainer can alternatively be operated and controlled via an end device. The user interface can also be displayed on additional end devices (screen mirroring).

- laboratory-scale wastewater treatment plant
- continuous operation
- nitrification
- pre-denitrification
- device control using an integrated PLC
- integrated router for operation and control via an end device and for screen mirroring on additional end devices: PC, tablet, smartphone

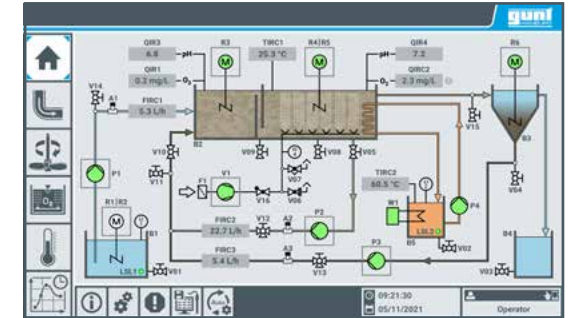

Touch screen: process schematic

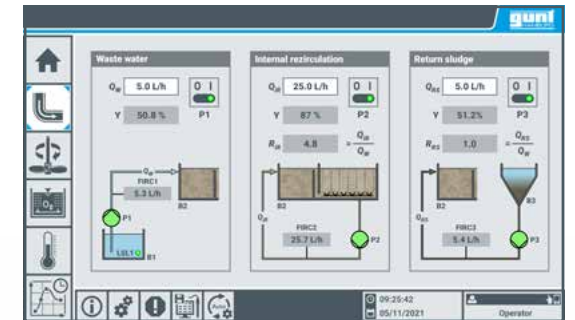

Touch screen: operation of the pumps



LAN/WLAN



About the product:





CE 705

Activated sludge process

Instrumentation and control technology

Nowadays, complex processes such as the activated sludge process are largely automated. The use of modern instrumentation and control technology is indispensable for this purpose. This also requires that engineers in the field of environmental engineering have at least basic knowledge of such systems.

To prepare students for the challenges of professional practice, we have also observed this important aspect when developing the device. CE 705 is therefore equipped with extensive instrumentation for measurements and a PLC with touch screen.

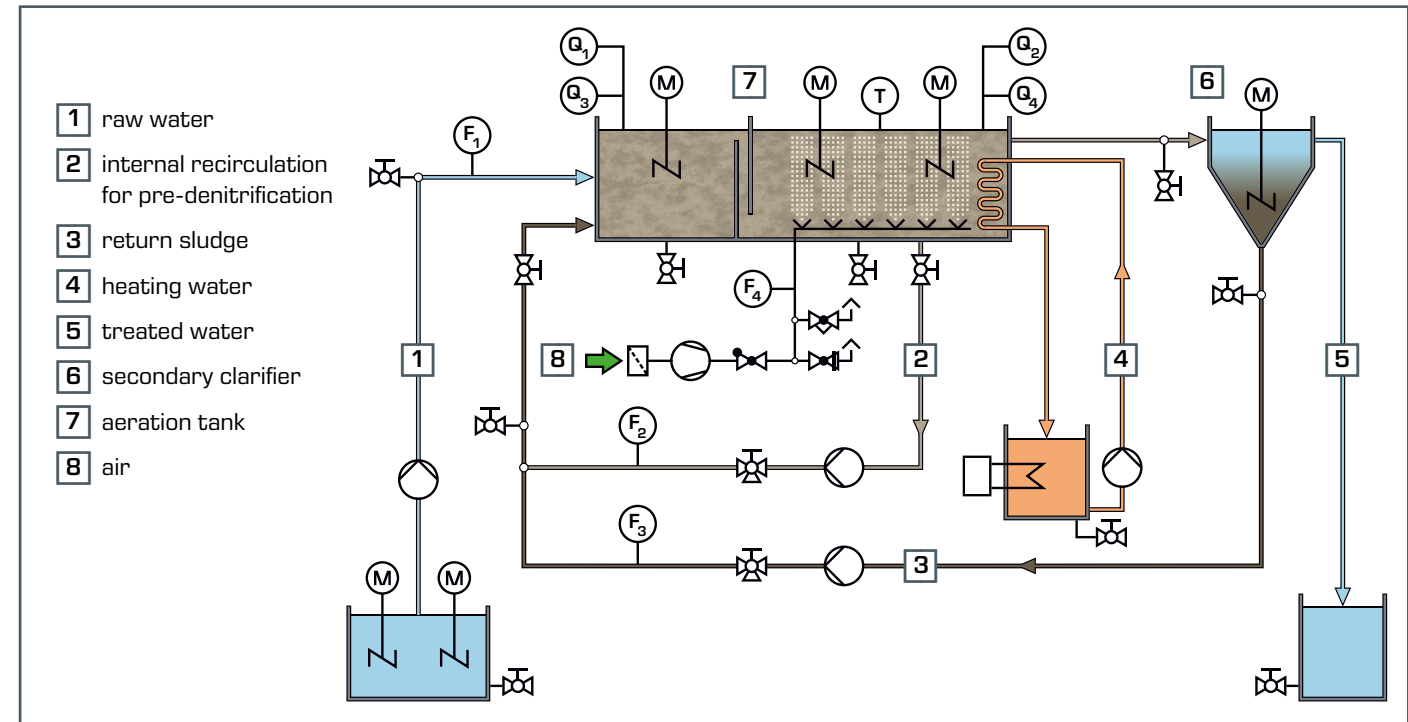

Instructional material

You also receive comprehensive instructional material about this device, which quickly helps you become familiar with its operation. In addition, the theoretical fundamentals of the activated sludge process are clearly represented in detail.



Commissioning and training

CE 705 is used in many educational institutions worldwide. Commissioning and training for customers is carried out by expert GUNT employees. In addition to testing the delivered products, GUNT technicians provide in-depth instruction to the customer on operation of the devices. This allows you to quickly incorporate the teaching system in your classroom.

Learning objectives

- functional principle of nitrification and pre-denitrification
- creation of a stable operating state
- identification of the following influencing factors
 - sludge age
 - volumetric loading
 - sludge loading
 - return sludge ratio
 - return ratio of the internal recirculation (denitrification)
- efficiency of the pre-denitrification
- influence of the following ambient conditions to the biological degradation
 - temperature
 - oxygen concentration

Measured variables			(Auto)
flow rate	F ₁	raw water	<input checked="" type="checkbox"/>
	F ₂	internal recirculation	<input checked="" type="checkbox"/>
	F ₃	return sludge	<input checked="" type="checkbox"/>
	F ₄	aeration	<input type="checkbox"/>
oxygen concentration	Q ₁	denitrification area	<input type="checkbox"/>
	Q ₂	nitrification area	<input checked="" type="checkbox"/>
pH value	Q ₃	denitrification area	<input type="checkbox"/>
	Q ₄	nitrification area	<input type="checkbox"/>
temperature	T	nitrification area	<input checked="" type="checkbox"/>



About the product:



After successful commissioning and training, a GUNT employee hands over CE 705 to Mrs. Professor Dr.-Ing. Deininger of the Deggendorf Institute of Technology (Germany).

TECHNISCHE HOCHSCHULE DEGGENDORF THD

Modern and practical training – supported by high-quality educational systems from GUNT

CE 704

SBR process

sequencing batch reactor

Discontinuous wastewater treatment

In the classic continuous activated sludge process, the individual process steps of biological treatment take place simultaneously and separately from each other. In contrast, in the SBR process these process steps take place sequentially in one tank. Treatment of the wastewater is therefore not continuous, but in batches. Accordingly, this type of reactor is called a Sequencing Batch Reactor (SBR).

At the beginning of a cycle, the reactor is filled with wastewater. This is followed by mixing and aeration phases. This sets the environment required for each process step. After a defined period of time, all stirring machines and aeration are switched off. This causes the activated sludge to sink to the bottom of the reactor. After completion of the sedimentation phase, the treated wastewater is pumped out of the reactor so that a new cycle can begin. The duration and arrangement of the individual phases can vary within a cycle. Only the sedimentation of the activated sludge and the withdrawal of the treated water are obligatory at the end of a cycle.

This teaching device is used to learn the basics of the SBR process in a practical way. The main component of the device is the reactor, which is equipped with a stirring machine and an aeration device. The stirring machine ensures sufficient mixing of the reactor contents even in phases without aeration (denitrification).

Using timers, you can individually set the aeration and mixing phases. The oxygen concentration, pH value and temperature in the reactor are recorded. A digital process controller continuously displays the measured values and the speed of the stirring machine. The process controller also functions as a controller for the oxygen concentration during the aeration phase. The process controller is very easy to use and is operated by means of a touch screen.

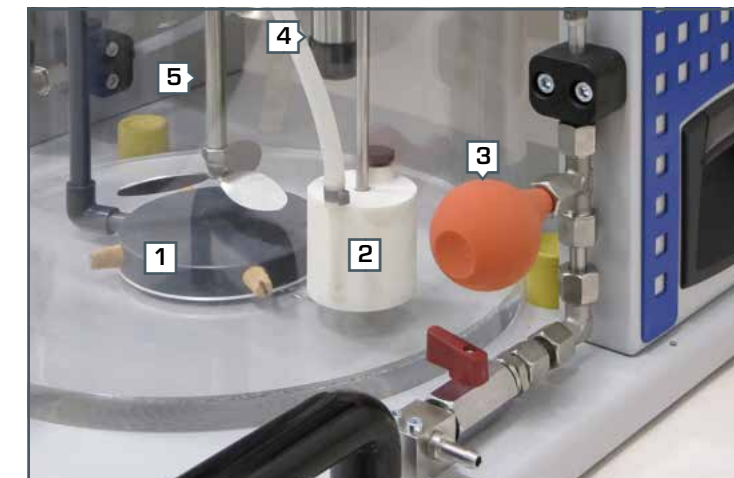
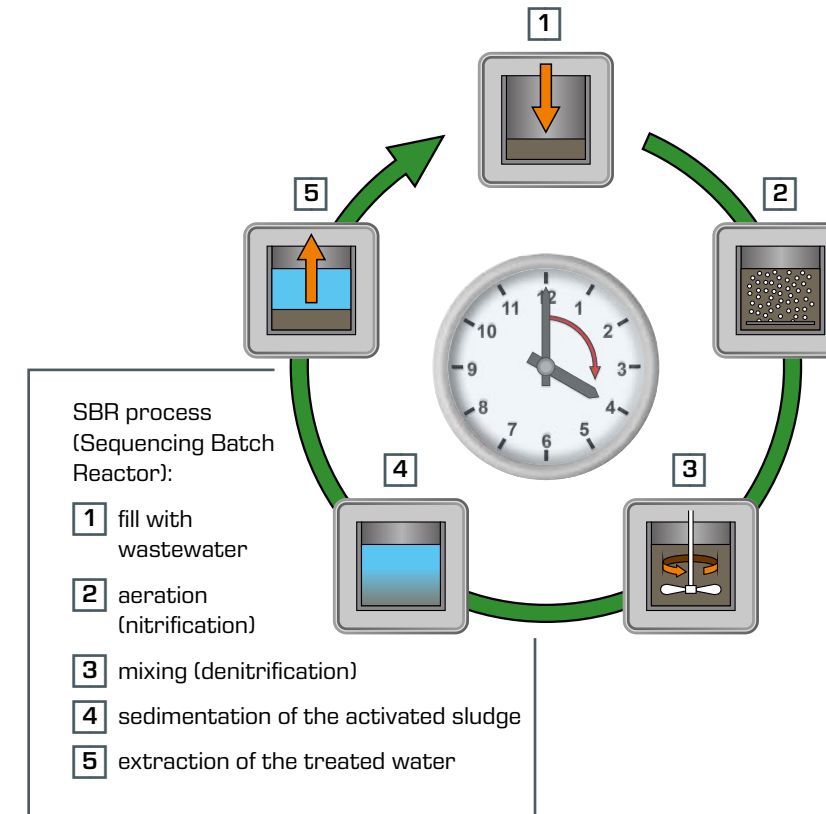

- 1 aeration device
- 2 floating device for clear water extraction
- 3 suction ball for clear water
- 4 oxygen sensor
- 5 stirring machine



Digital process controller for displaying the process variables and for controlling the oxygen concentration

Learning objectives

- functional principle of the SBR process
- elimination of nitrogen by nitrification and denitrification
- influence of cycle design on treatment results
- recording and interpretation of temporal concentration curves
- determining conversion rates
- sedimentation properties of activated sludge

About the product:





CE 701

Biofilm process laboratory-scale trickling filter

Trickling filters: an aerobic biofilm process

Although trickling filters are one of the oldest biological wastewater treatment processes, they are still widely in use. The trickling filter process is therefore still an integral part of the curriculum in the field of water treatment.

The CE 701 trickling filter is designed for carbon elimination and nitrification. A rotary distributor distributes the wastewater to be treated evenly over the fixed bed. You can adjust the speed of the rotary distributor. There are two different HDPE packing types available for the fixed bed. The packing differs in terms of the specific surface area.

The trickling filter of CE 701 has aeration vents below the fixed bed. This allows for aeration by natural convection. If necessary, you can also close the aeration vents to artificially aerate the trickling filter with a compressor.

The instructional material sets out the fundamentals and design of trickling filter plants in detail. A detailed description of the device and the experiments enables you to quickly incorporate this training system into your classroom.

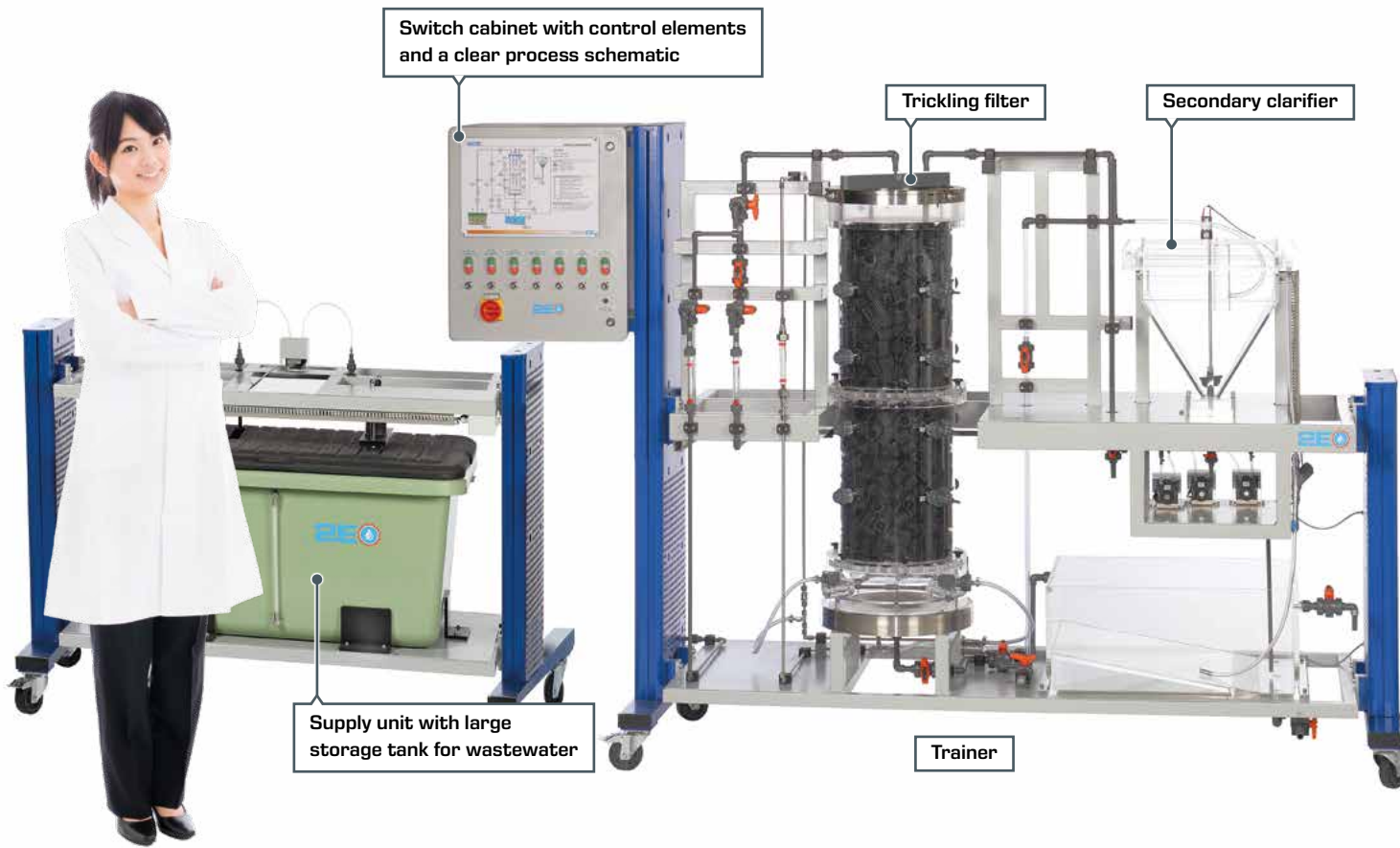

Rotary distributor on the head of the trickling filter with variable speed adjustment



Sampling point within the trickling filter



CE 701 instructional material

Concentration profiles

Sampling points are located within the fixed bed. This allows you to determine the concentration profiles of BOD₅, ammonia and nitrate which are characteristic for trickling filters.

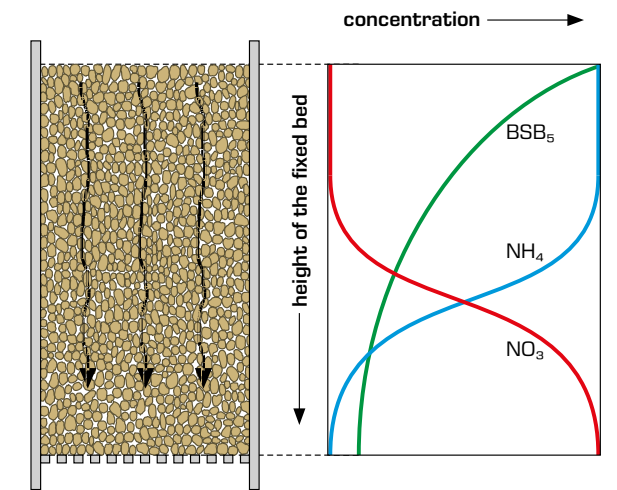

Typical concentration profiles of BOD₅, ammonia (NH₄) and nitrate (NO₃) in a trickling filter

- Learning objectives**
- functional principle of a trickling filter
 - recording of concentration profiles
 - creation of a stable operating state
 - identification of the following influencing factors
 - ▶ flow rate of recirculation
 - ▶ volumetric loading of the trickling filter
 - ▶ surface loading of the trickling filter
 - comparison of various packing types

About the product:





CE 730

Airlift reactor

Powerful bioreactors

Supplying the microorganisms (biomass) with oxygen is of crucial importance for the performance of an aerobic bioreactor. Another important aspect is uniform mixing of the reactor contents. Airlift reactors meet both of these challenges to a particular degree.

In an airlift reactor mixing occurs exclusively through the aeration, which is necessary anyway. Mechanically moving parts (e.g. stirring machines) are not necessary. The retention of the biomass in the reactor required for effective operation is achieved by circulation. Airlift reactors are used in biotechnology and in biological wastewater treatment.

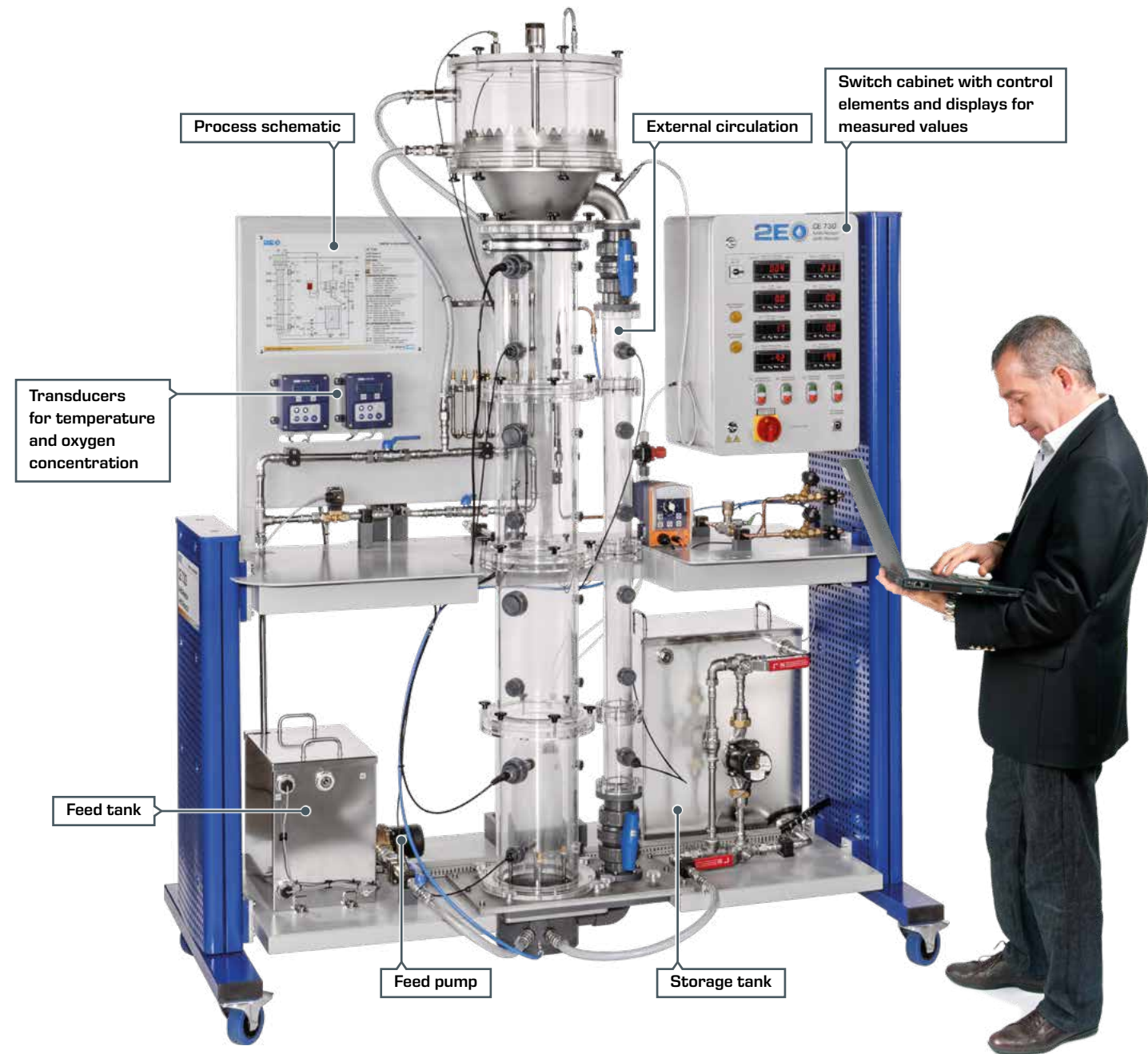

Airlift reactor CE 730

The educational focus is the functional principle and operation of an airlift reactor. These mainly include releasing oxygen in the liquid phase (water) and determining the flow conditions in the reactor.

The core of the trainer is an airlift reactor with external circulation. There are several different distributors available for aeration of the reactor. This allows you to study how bubble size influences mass transfer. Two measuring points for conductivity are located on the circulation at defined intervals. Adding a salt solution causes a sharp increase (peak) in conductivity at both measurement points, with some delay between them. The time difference between the two peaks and the distance between the measuring points can be used to determine the flow velocity in the reactor.



Airlift reactor during a test run

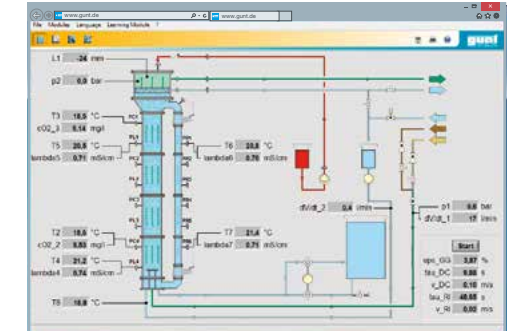

Software

The clearly-arranged software included with CE 730 continuously displays all key process variables. You can of course save the measured values for analysis.



Various distributors for aerating the reactor

Learning objectives

- influence of the superficial gas velocity on:
 - ▶ gas content
 - ▶ mass transfer coefficient
 - ▶ mixing time
 - ▶ superficial fluid velocity

About the product:





CE 702

Anaerobic water treatment

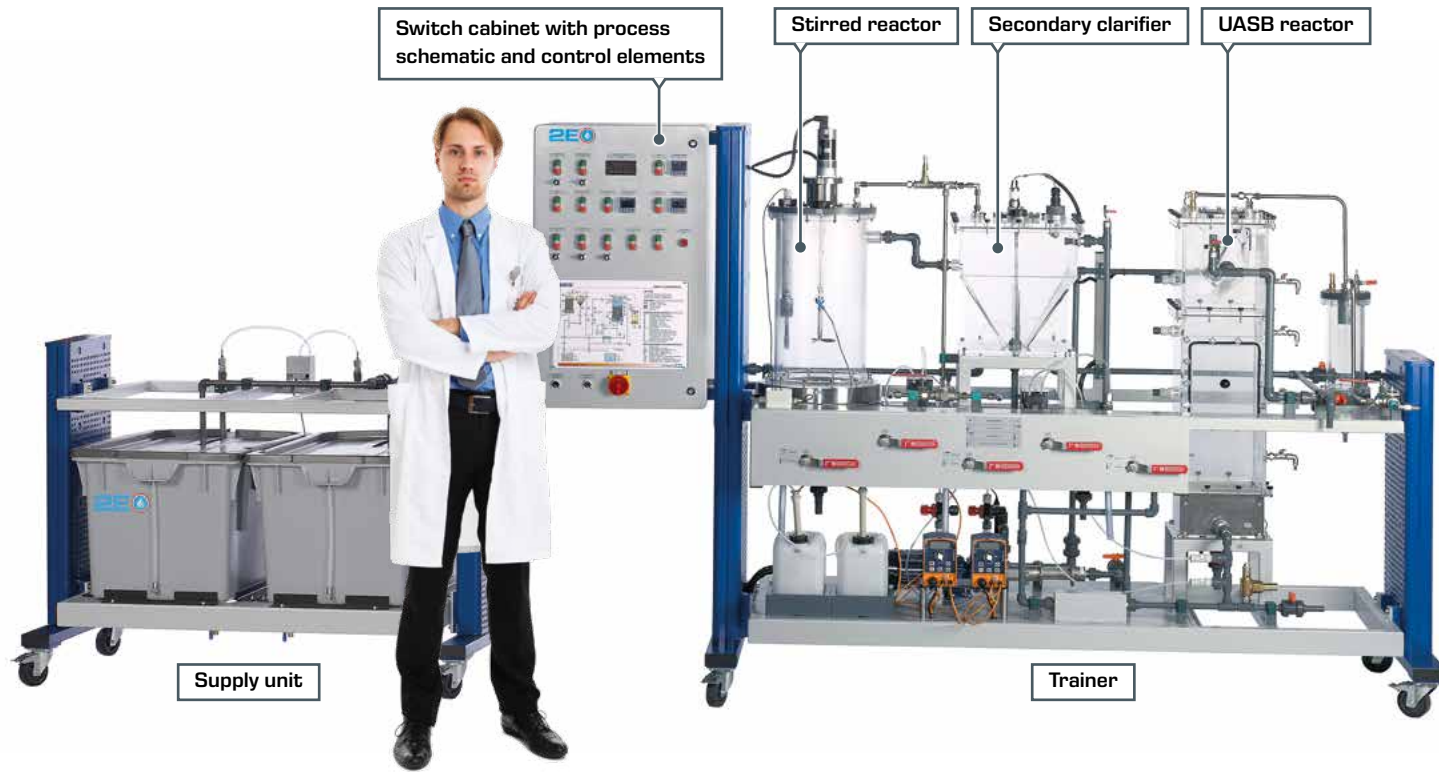

Anaerobic processes are primarily used for wastewater which is highly contaminated with organic substances, such as those occurring in the food industry.

Our CE 702 teaching unit offers you two different methods. These are the anaerobic activated sludge process and the UASB process. You can operate both processes separately (1-stage) or in series (2-stage). This gives you a total of three different modes of operation. The device is also equipped with extensive instrumentation and control technology and software.

You also receive comprehensive instructional material on this device that quickly helps you become familiar with operation of the device. In addition, the theoretical fundamentals of anaerobic wastewater treatment are clearly represented in detail.

The 2-stage operating mode allows you to control the pH and the temperature independently of each other in both stages. This type of process control has proven itself in practice and has the advantage of being able to better adapt the environmental conditions to the needs of each of the degradation steps. The device is equipped with gas collecting pipes, which can be used to take gas samples from the system for analysis.

About the product:



Operating mode 1 (1-stage)	
Operating mode 2 (1-stage)	
Operating mode 3 (2-stage)	

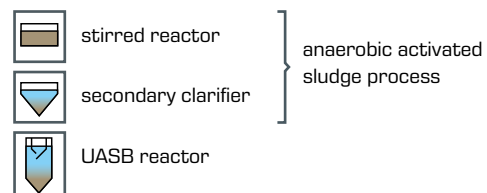

CE 702's UASB reactor during a successful trial run in our laboratory

Software

The software included with CE 702 shows the temperatures and pH values in both reactors continuously. This gives you a quick overview of the conditions in the reactors at any time. You can save the measured values for analysis. This relieves you of routine work and thus aids you when conducting the experiments.

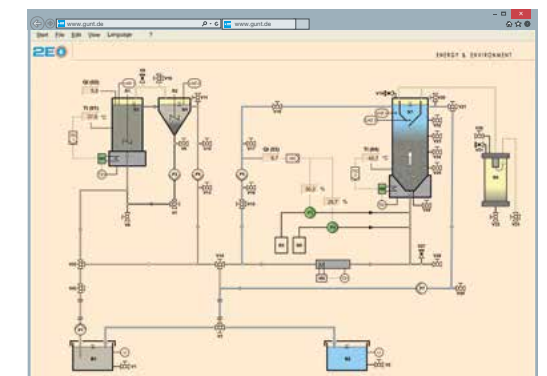

Process schematic with display of the measured values

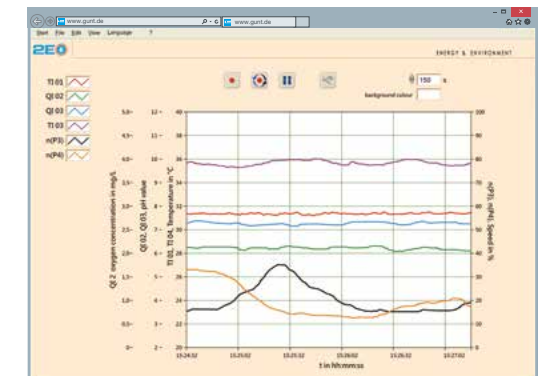

Display of the measured values as time dependency

Learning objectives

- effects of temperature and pH value on anaerobic degradation
- functional principle of a UASB reactor
- comparison of single stage and dual stage operation mode
- monitoring and optimisation of the operating conditions
- identification of the following influencing factors
 - ▶ sludge loading
 - ▶ volumetric loading
 - ▶ flow velocity in the UASB reactor



Basic knowledge Physical/chemical water treatment

Application of physical/chemical processes

Industrial wastewater often contains dissolved inorganic substances (e.g. heavy metals) or organic materials which cannot be biodegraded. This is also true of a lot of landfill leachate and contaminated groundwater. The use of physical/chemical processes is ideal in such cases. There is a variety of different processes in this field of water treatment. The most widely used processes include:

Adsorption	Reverse osmosis	Ion exchange
Precipitation	Flocculation	Oxidation processes



Continuous-flow adsorber in a water treatment plant

Adsorption

In adsorption, the material to be removed (adsorbate) is bonded to the surface of a solid (adsorbent). This bonding can be either physical or chemical. The adsorbent is predominantly granular activated carbon. This procedure can be used to reliably remove toxic, chlorinated hydrocarbon compounds from the water. Such substances are found in many places in landfill leachate and contaminated groundwater.

Adsorption is generally carried out with continuous-flow adsorbers. The adsorbers contain a fixed bed of granular activated carbon. After a certain period of operation, the adsorbate concentration in the outlet of an adsorber rises. This condition is referred to as breakthrough. If the adsorbate concentration in the outlet of an adsorber is plotted over time, it shows what is known as the breakthrough curve.

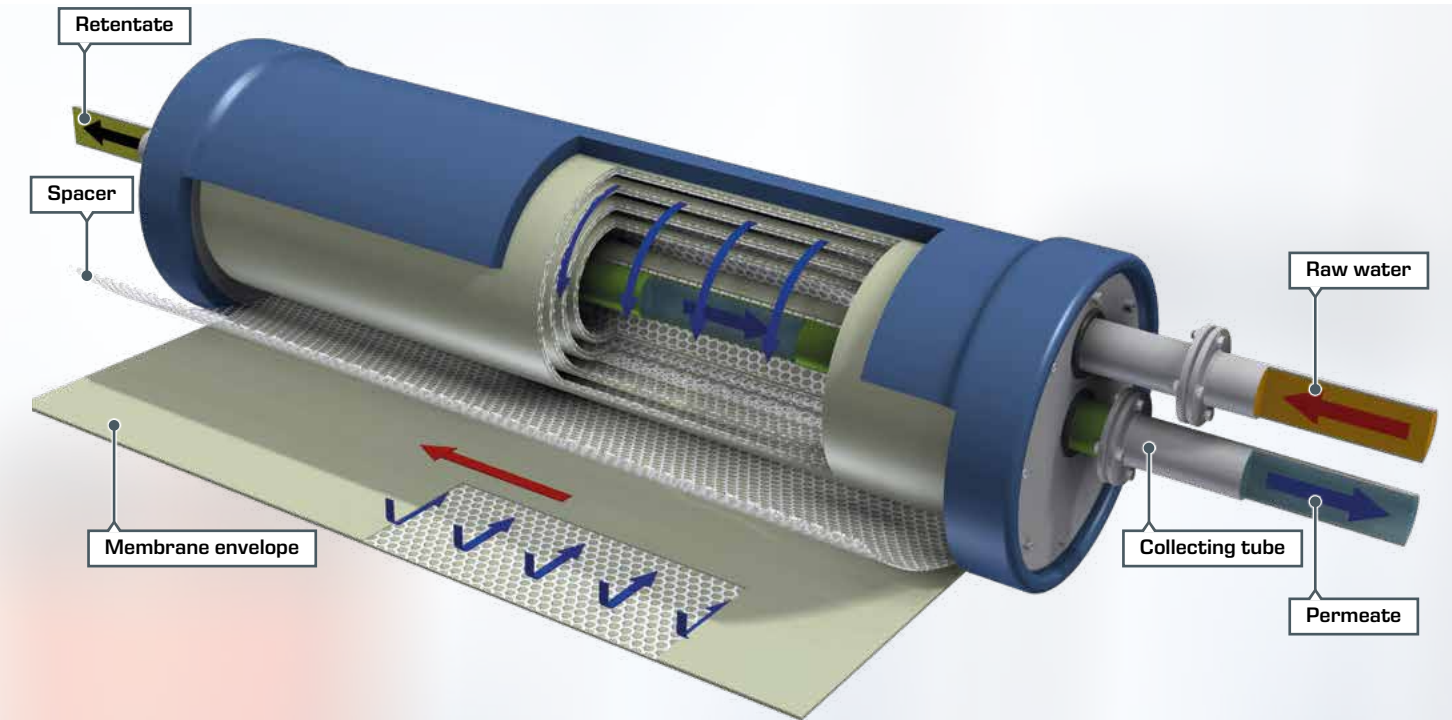

Reverse osmosis: membrane separation process for the strictest demands

The basic principle of reverse osmosis is quite simple. The natural tendency to bring about a concentration equilibrium between the two sides of a membrane (osmosis) must be countered. To do this, counter-pressure which is at least as high as the osmotic pressure is built up. The water then flows across the membrane in the direction of the concentration gradient, thereby sharply increasing the concentration on one side of the membrane (retentate) and decreasing it on the other side (permeate). To put it simply, reverse osmosis can be regarded as a dilution process.

Even dissolved substances such as ions can be removed from the water by reverse osmosis. This means ultrapure water, which is required in many sensitive industrial production processes, can be produced, for example in the pharmaceutical industry. Another application is the desalination of sea water.

Reverse osmosis uses what are known as spiral-wound membranes. One special feature of this design is the membrane envelope wound spirally around a central tube. The high pressure on the inlet side causes the water (permeate) to pass across the membrane and to flow spirally into the central collecting tube. The partial flow (retentate) retained by the membrane is removed via a separate tube.



Basic knowledge Physical/chemical water treatment

Ion exchange

Ion exchange is a physico-chemical process in which a solid absorbs ions from a liquid, and in exchange emits an equivalent amount of equally charged ions to the liquid. If positive ions are exchanged (e.g. sodium Na⁺), the process is called cation exchange. In contrast, anion exchange is where negatively charged ions are exchanged (e.g. chloride Cl⁻).

Ion exchangers are used primarily for desalination and softening. Heavy metals contained in a lot of wastewater from the metal-working industry can be removed by ion exchange.

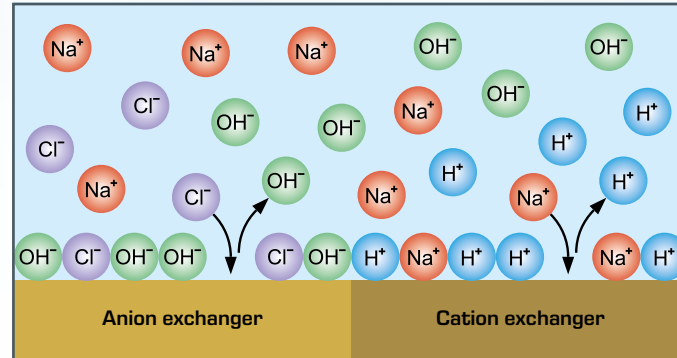

Desalination by anion exchange followed by cation exchange

Precipitation

Precipitation is a chemical process in which a dissolved substance is transformed in an insoluble form (solid) by reaction with another substance. Precipitation is suitable for removing dissolved metals, for example. In addition, precipitation is also used for phosphorus elimination in wastewater treatment plants.

In practice, precipitation is often followed by flocculation in order to increase the size of the solids which are formed. This eases the subsequent mechanical separation of the solids (for example by sedimentation).

Flocculation

To add certain chemicals the electrostatic repulsive forces between the individual solid particles have to be removed first. As a result, the particles combine to form small flocs (coagulation). To increase the size of the flocs even further, a flocculant (e.g. polymer) is added to the water. This results in flocs several millimetres in diameter, which can easily be separated subsequently by mechanical means.

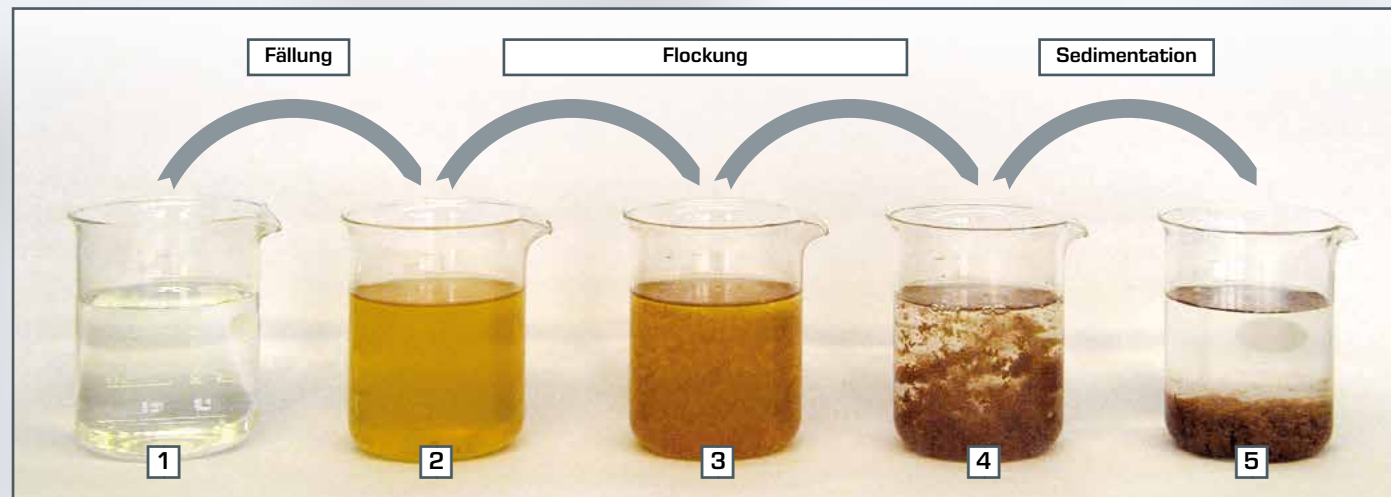

Precipitation and flocculation of dissolved iron:
By adding caustic soda, the dissolved iron (1) first precipitates as insoluble and yellow iron hydroxide (2). Adding other chemicals causes large iron hydroxide flocs (3 to 4) to form, which can then easily be separated by sedimentation (5).

Oxidation processes

Many organic contaminants are not biodegradable and therefore cannot be eliminated by biological processes. These include many chlorinated hydrocarbons. Improper handling of these materials allows them to enter the groundwater where they pose a threat to humans and the environment. An effective method of removing such materials from the water is with oxidation processes.

There is a variety of different oxidation processes in the field of water treatment. The importance of those referred to as "advanced oxidation processes" has increased in the past few

years. The main feature of these processes is the formation of highly reactive OH radicals. These radicals are some of the strongest oxidants and thus are able to oxidise almost any substance.

OH radicals can be produced with UV light, for example by irradiation of hydrogen peroxide (H₂O₂). UV-C radiation with a wavelength of 254 nm is mainly used for this purpose.

Producing an OH radical with UV light and hydrogen peroxide (H₂O₂)

- oxygen
- hydrogen
- free electron



CE 583

Adsorption



Adsorptive water treatment in continuous operation

Adsorption on activated carbon is an effective and often practised alternative to the removal of non-biodegradable organic substances, such as chlorinated hydrocarbons. Our CE 583 device allows you to demonstrate the fundamentals of this process in continuous operation and therefore under very practical conditions.

The main components of this device are two series-connected adsorbers which are filled with granulated active carbon. The first adsorber is equipped with sampling valves so that you can determine concentration profiles. Concentration profiles are essential for understanding adsorption.

Principle of operation

Treated water is circulated through both adsorbers. A metering pump injects concentrated adsorbate solution into the inlet area of the first adsorber in the circuit. The metering pump allows very precise adjustment of the flow rate. This allows you to adjust the desired feed concentration of the adsorbate very precisely. The second adsorber ensures that the circulated water doesn't contain any more adsorbate even at full breakthrough of the first adsorber. This ensures a constant adsorbate concentration in the inlet of the first adsorber, even in long-term experiments.

Temperature control

The device is equipped with a temperature control system. This allows you to study how water temperature influences the adsorption process.

i Our recommendation

You can deliver a particularly impressive demonstration of adsorption when you use a water-soluble and adsorbable dye as the adsorbate. Such substances include methylene blue or fluoresceine.

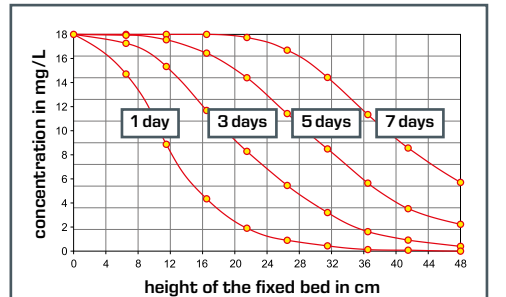

Excerpt from the CE 583 manual: concentration profiles at various times for methylene blue



- 1 adsorbate concentrate
- 2 treated water
- 3 metering pump
- 4 circulation pump
- 5 first adsorber
- 6 second adsorber
- 7 switch cabinet
- 8 process schematic
- 9 test tubes for sampling

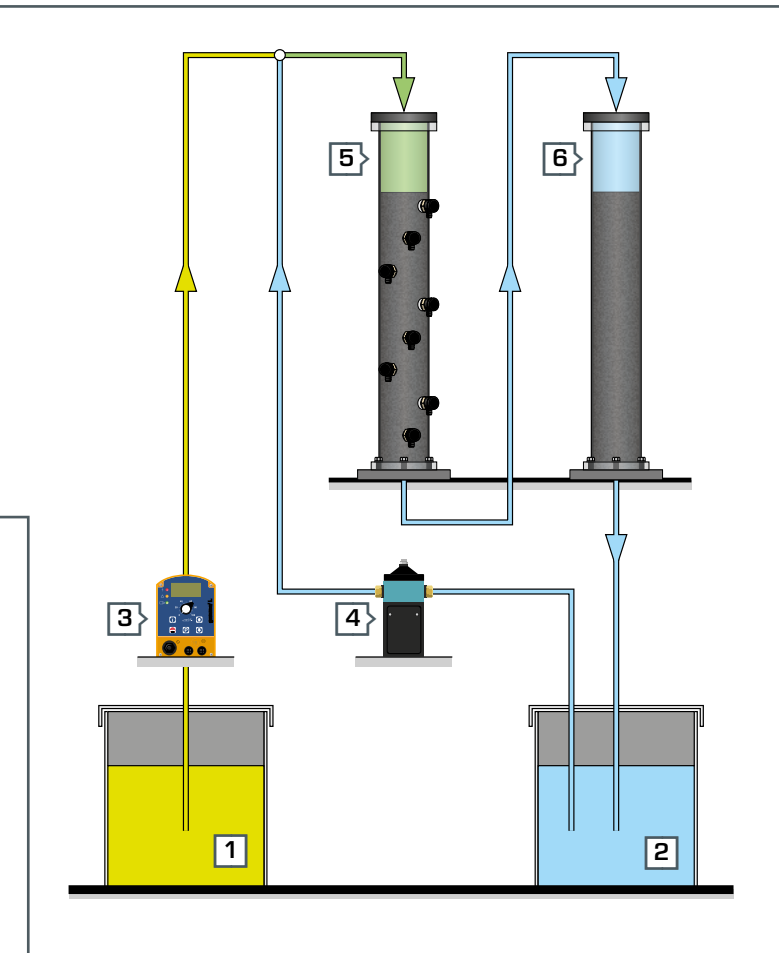

i Adsorbate
 Adsorbate refers to the substance dissolved in the water which is to be eliminated by adsorption

About the product:



- Learning objectives**
- recording of concentration profiles
 - recording of breakthrough curves
 - relationship between concentration profiles and breakthrough curves
 - determining the mass transfer zone
 - an adsorber's efficiency and mass balance
 - predicting breakthrough curves
 - scale-up of the results to industrial scale
 - factors influencing the adsorption
 - ▶ contact time
 - ▶ temperature
 - ▶ mode of operation



CE 530

Reverse osmosis

This device has been developed in collaboration with the Institute of Thermal Separation Processes, Hamburg University of Technology.

The main component of CE 530 is the spiral-wound membrane. The construction, maintenance and operation of a spiral-wound membrane are the focal points of the didactic concept, as is the determination of specific parameters (e.g. retention capacity). The device is designed for water desalination. In order to

monitor the success of desalination, conductivity sensors are installed at all relevant points in the device. You can adjust the pressure and flow rate.

The instructional material sets out the fundamentals in detail and provides a step-by-step guide through the experiments.

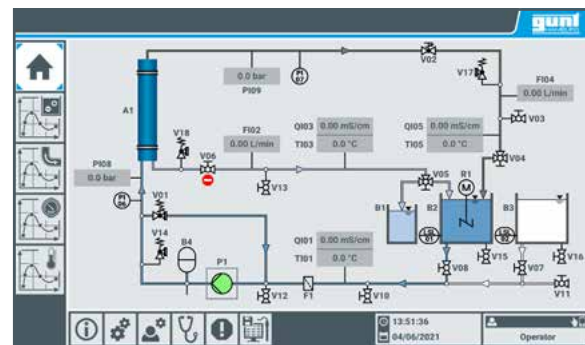
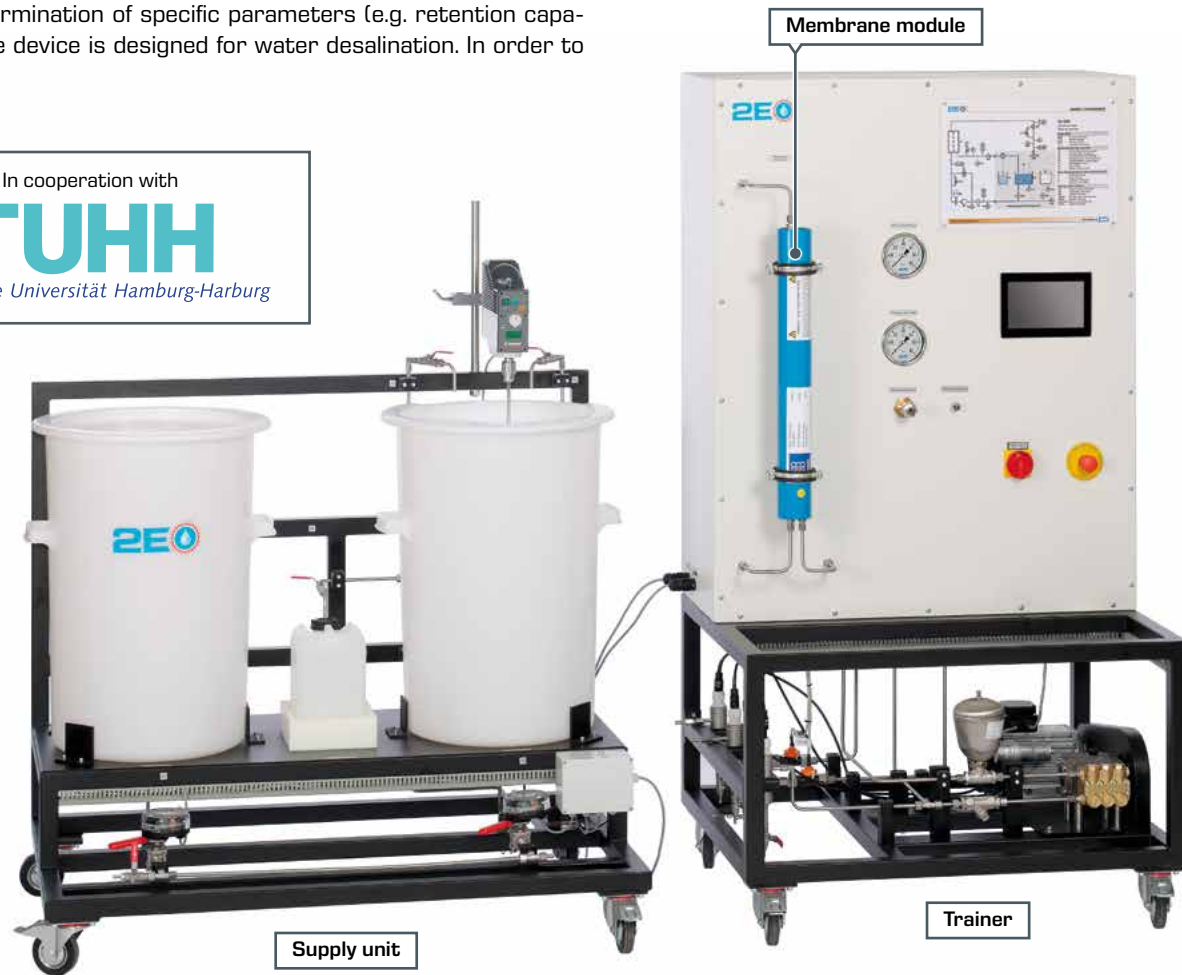

Touch screen: process schematic

About the product:



CE 300

Ion exchange

Ion exchangers are used primarily for the desalination and softening of water. Our CE 300 experimental unit allows you to demonstrate all the key aspects of ion exchange to your students.

The device has one anion exchanger and one cation exchanger. The two ion exchangers can be perfused either separately in sequence or simultaneously by simply adjusting the valves. A hand-held instrument for measuring conductivity is included for analysis of the experiments. You can regenerate the ion exchangers with acid or alkaline solution. Due to its small size, this device does not require a large laboratory and can easily be set up on tables.

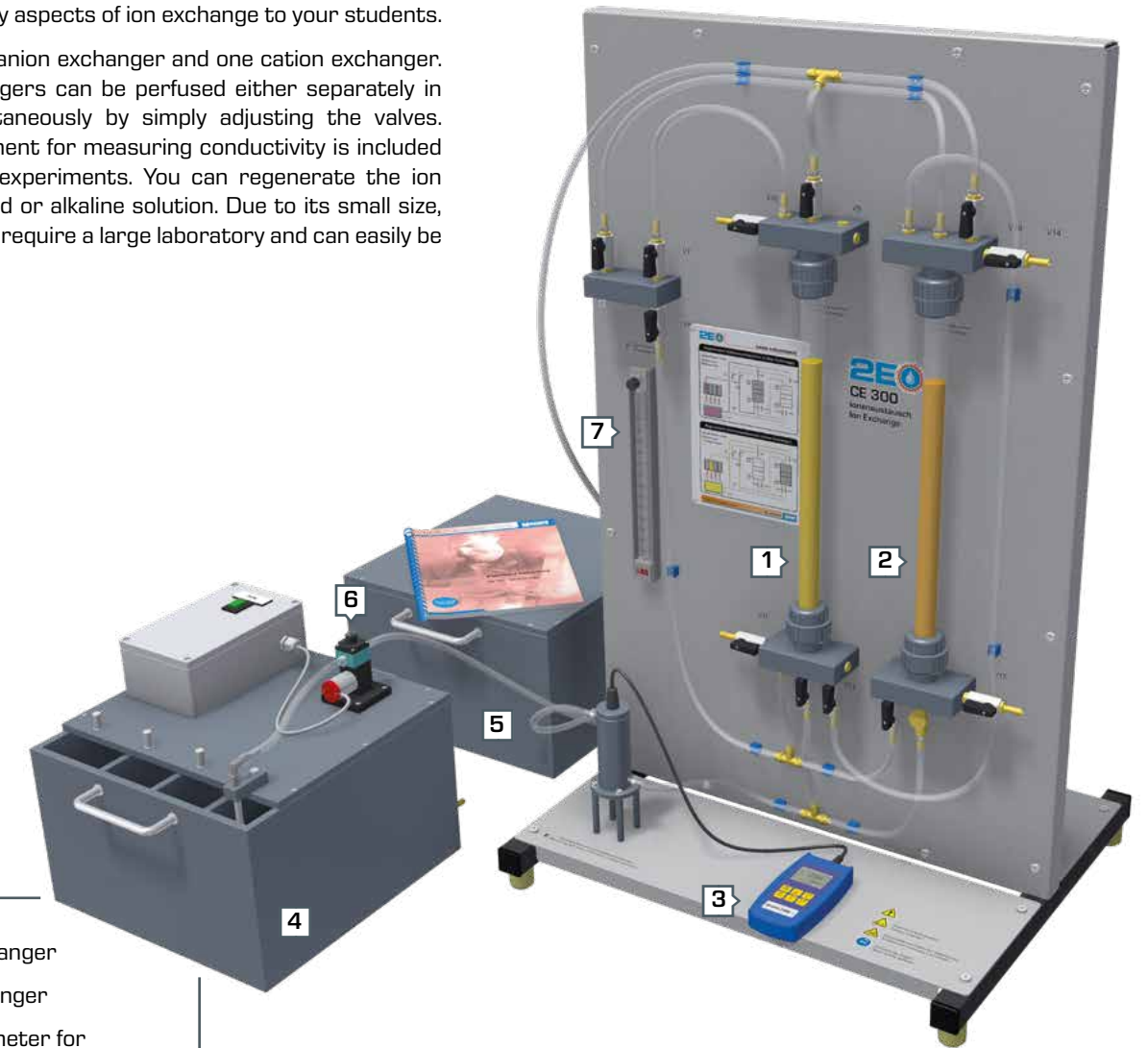

- 1 cation exchanger
- 2 anion exchanger
- 3 hand-held meter for conductivity
- 4 feed tank for raw water and regeneration agent
- 5 collecting tank
- 6 pump
- 7 flow meter

About the product:



Learning objectives

- functioning of a spiral-wound membrane module
- assembly, cleaning and conservation of membrane modules
- fundamental principle of reverse osmosis
 - ▶ Van't Hoff's law
- permeate flow rate and retention dependent on
 - ▶ pressure
 - ▶ salt concentration in raw water
 - ▶ yield
- determination of diffusion coefficients

Learning objectives

- functioning of cation and anion exchangers
- desalination by a combination of cation and anion exchangers
- determining the exchanging capacity and regeneration
- checking the theoretically calculated regeneration time



CE 586

Precipitation and flocculation

This device can be used to demonstrate precipitation and flocculation in continuous operation and under very realistic conditions. This process is divided into three stages: precipitation, flocculation and sedimentation. All the necessary components are clearly arranged on the trainer. A separate supply unit with a large storage tank is available to produce and pump the raw water.



Precipitation

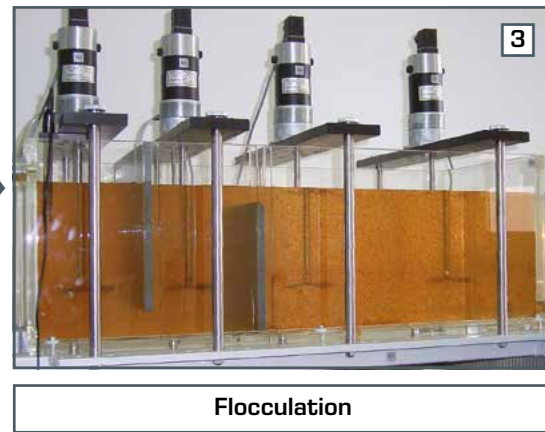

Flocculation

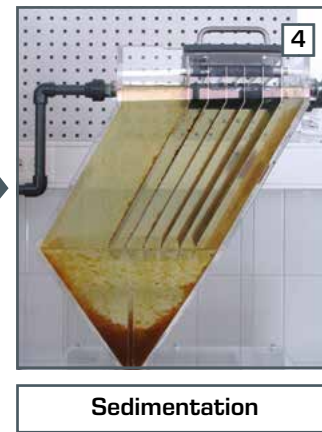

Sedimentation

- 1 storage tank for raw water
- 2 precipitation tank
- 3 flocculation tank
- 4 lamella separator
- 5 tank for treated water
- 6 metering pump for additives
- 7 switch cabinet with large process schematic
- 8 meter for conductivity

i This device is of course accompanied by comprehensive instructional material.

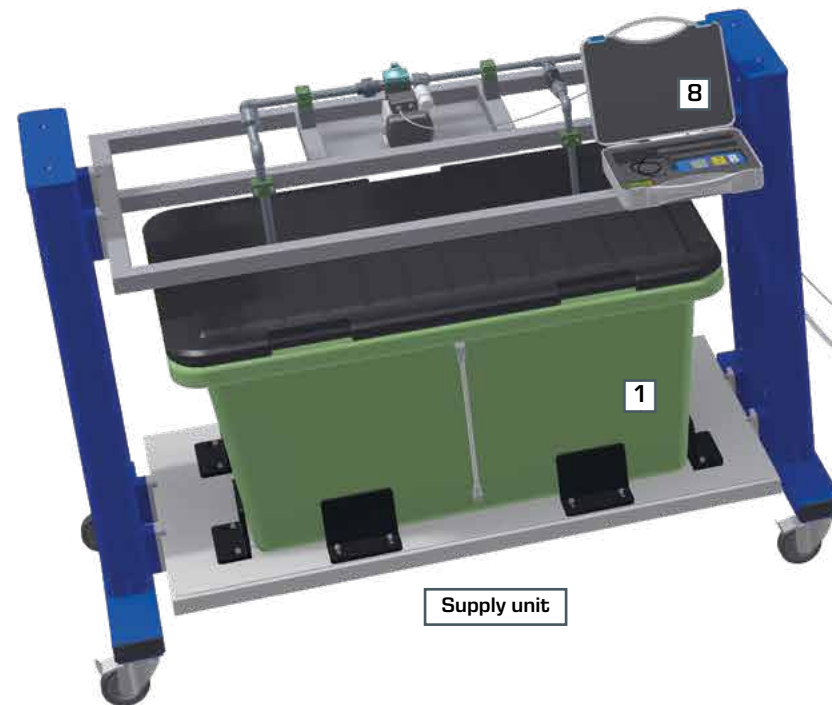

Supply unit

CE 586 is used at many universities worldwide, such as at the British University in Egypt (Cairo).

BUE
The British University in Egypt
الجامعة البريطانية في مصر
Department of Civil Engineering

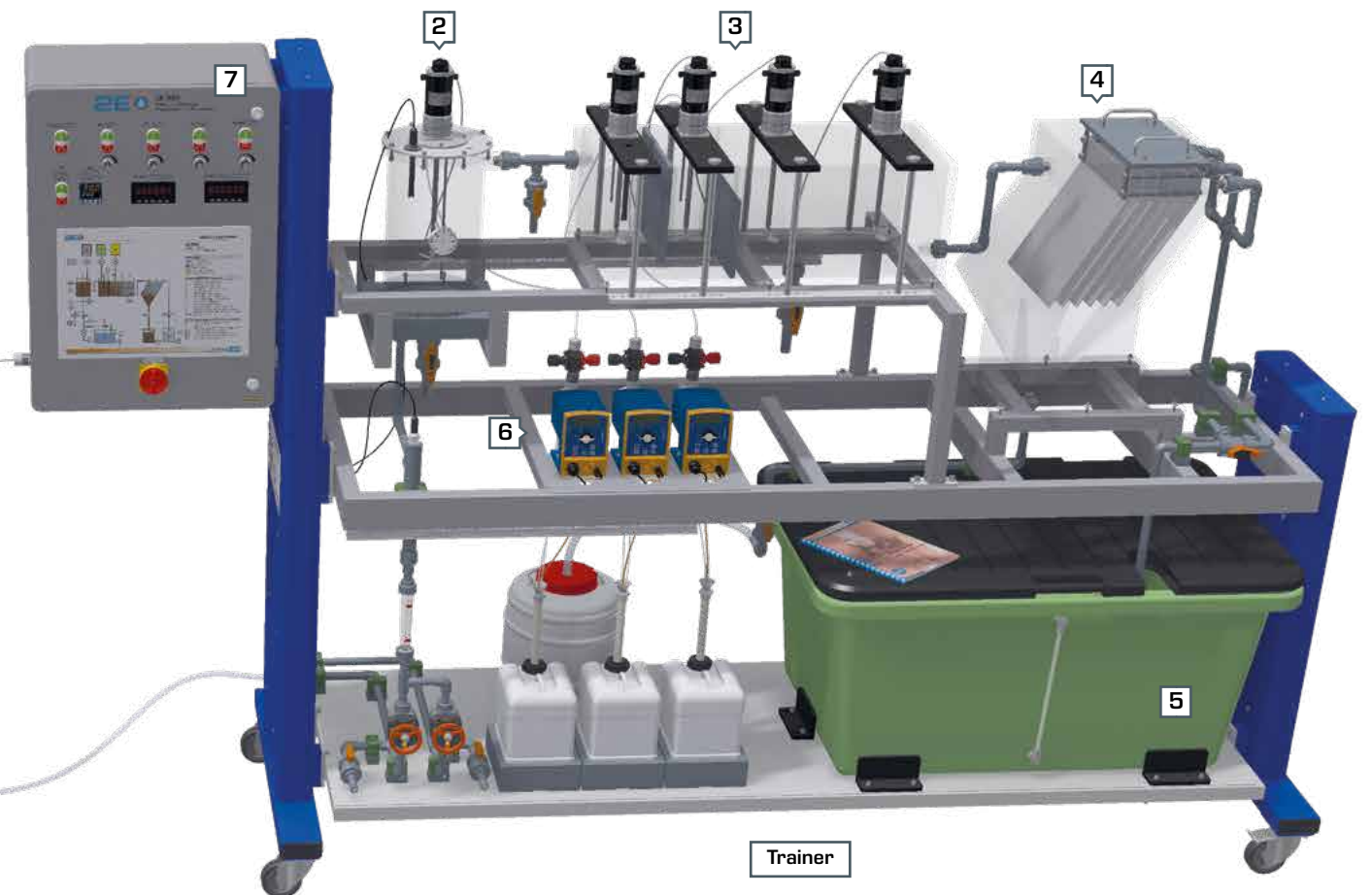

Trainer

About the product:



Learning objectives
■ effect of the pH value on precipitation
■ creation of a stable operating state
■ determining the required dosages of agents
■ functional principle of a lamella separator



CE 584

Advanced Oxidation

H₂O₂ and UV

Falling film reactor in batch mode

Advanced oxidation processes are state-of-the-art in water treatment. This device enables you to investigate the oxidation of non-biodegradable organic substances using hydrogen peroxide (H₂O₂) and UV radiation. The educational focus is on the experimental application of reaction kinetics relationships.

The main component of the device is a falling film reactor, which is operated discontinuously. The raw water mixed with hydrogen peroxide is pumped out of a tank into a channel at the upper end of the reactor. The water flows along the inner wall of the reactor, over an overflow edge, flows down as a thin film and finally ends up back in the tank.

At the centre of the reactor there is a UV lamp. Irradiation with UV light (254 nm) causes the hydrogen peroxide to be split into the desired OH radicals.

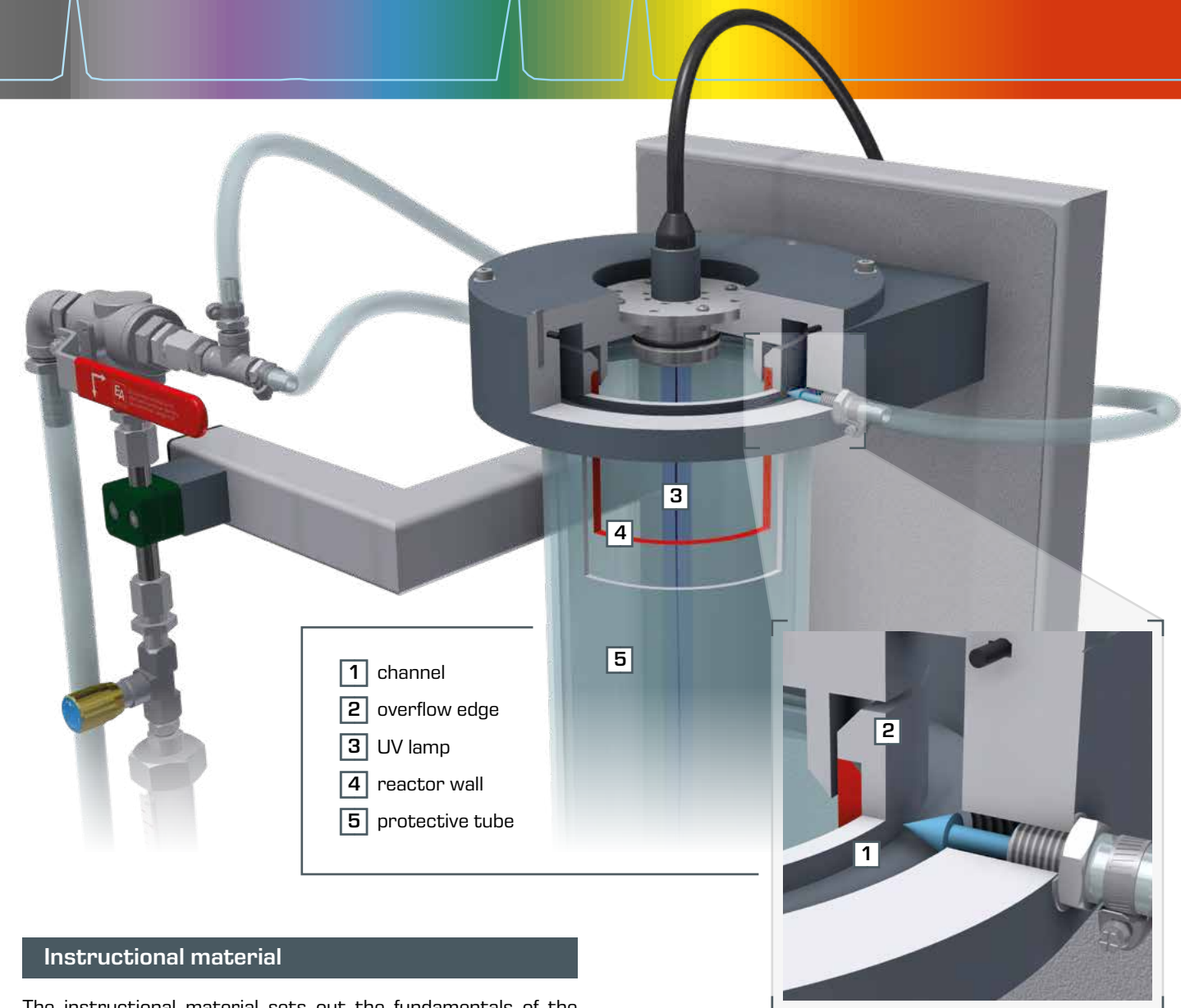

Instructional material

The instructional material sets out the fundamentals of the process and the reaction kinetics relationships in detail. In addition, an experiment is described in detail and evaluated as an example.

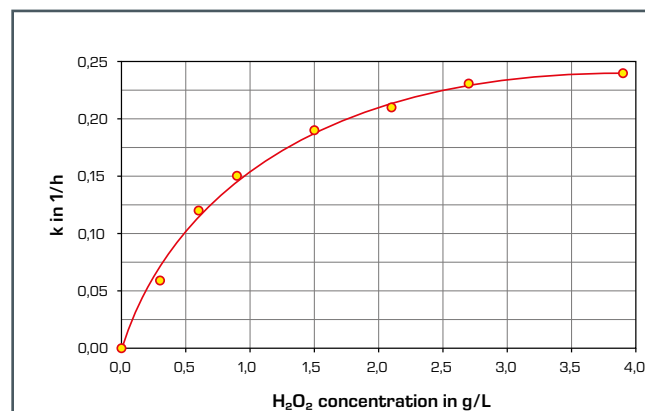

Excerpt from the CE 584 manual: rate constant k as a function of the amount of H₂O₂ used. Triethylene glycol dimethyl ether was used as the organic contaminant.

Learning objectives

- plotting concentration time curves
- investigation of reaction kinetics
 - ▶ order of reactions
 - ▶ reaction rate
- effect of amount of H₂O₂ on the reaction progress

About the product:





Basic knowledge Multistage water treatment

Multistage water treatment

Water to be treated usually contains several substances with different properties. Consequently, a single basic process is not sufficient to remove these substances. Water treatment plants are therefore generally built in several stages.

From the point of view of environmental protection, plants for treating contaminated groundwater are a classic application example of complex, multistage water treatment.

Solids contained in the untreated raw water can cause damage or blockages in plant components (e.g. pipelines and pumps). A mechanical treatment is therefore first applied to remove the solids. If the solids only emerge during the course of the water treatment, such as precipitation and flocculation, mechanical treatment steps are also used in the later stages of water treatment.

Groundwater treatment

Contaminated groundwater is usually treated with the "pump and treat" method. Here, the groundwater is pumped downstream of the contamination zone and purified by conventional processes of water treatment. The purified groundwater is then infiltrated back into the ground upstream of the contamination zone. This creates a circuit into which the groundwater treatment plant is integrated.

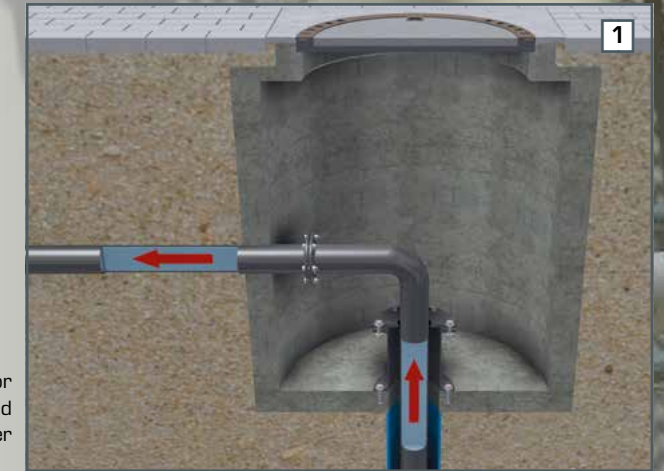

Well for contaminated groundwater



- Multistage groundwater treatment plant**
- 1 wells
 - 2 inlet of wells
 - 3 precipitation (e.g. dissolved iron)
 - 4 flocculation
 - 5 lamella separator (sedimentation)
 - 6 buffer tank
 - 7 sand filter
 - 8 stripping
 - 9 collection tank for sludge
 - 10 adsorption on activated carbon
 - 11 adsorber for exhaust air from stripping
 - 12 collection tank for purified groundwater
 - 13 outlet to infiltration wells
 - 14 infiltration wells



CE 581

Water treatment plant 1

This device allows you to clearly demonstrate and investigate the features of multistage water treatment. There are six consecutive process steps available.

Depth filtration	1 gravel filter
	2 sand filter
Adsorption	3 aluminium oxide
	4 activated carbon
Ion exchange	5 mixed bed exchanger
	6 cation exchanger

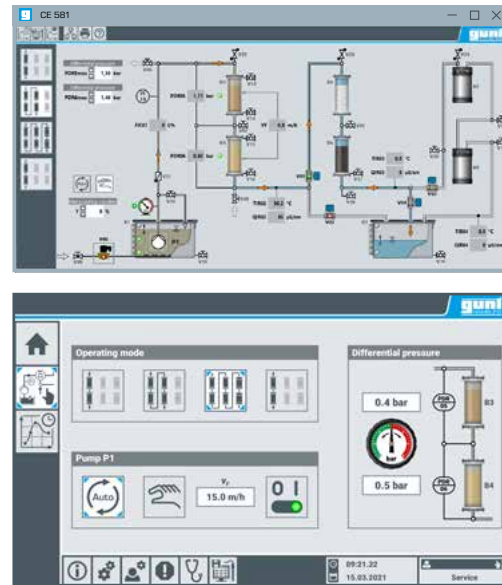

Software and PLC

The device is operated with a PLC (programmable logic controller). The software displays all the measured process variables continuously. Of course, the software also allows you to save the measured values for analysis.

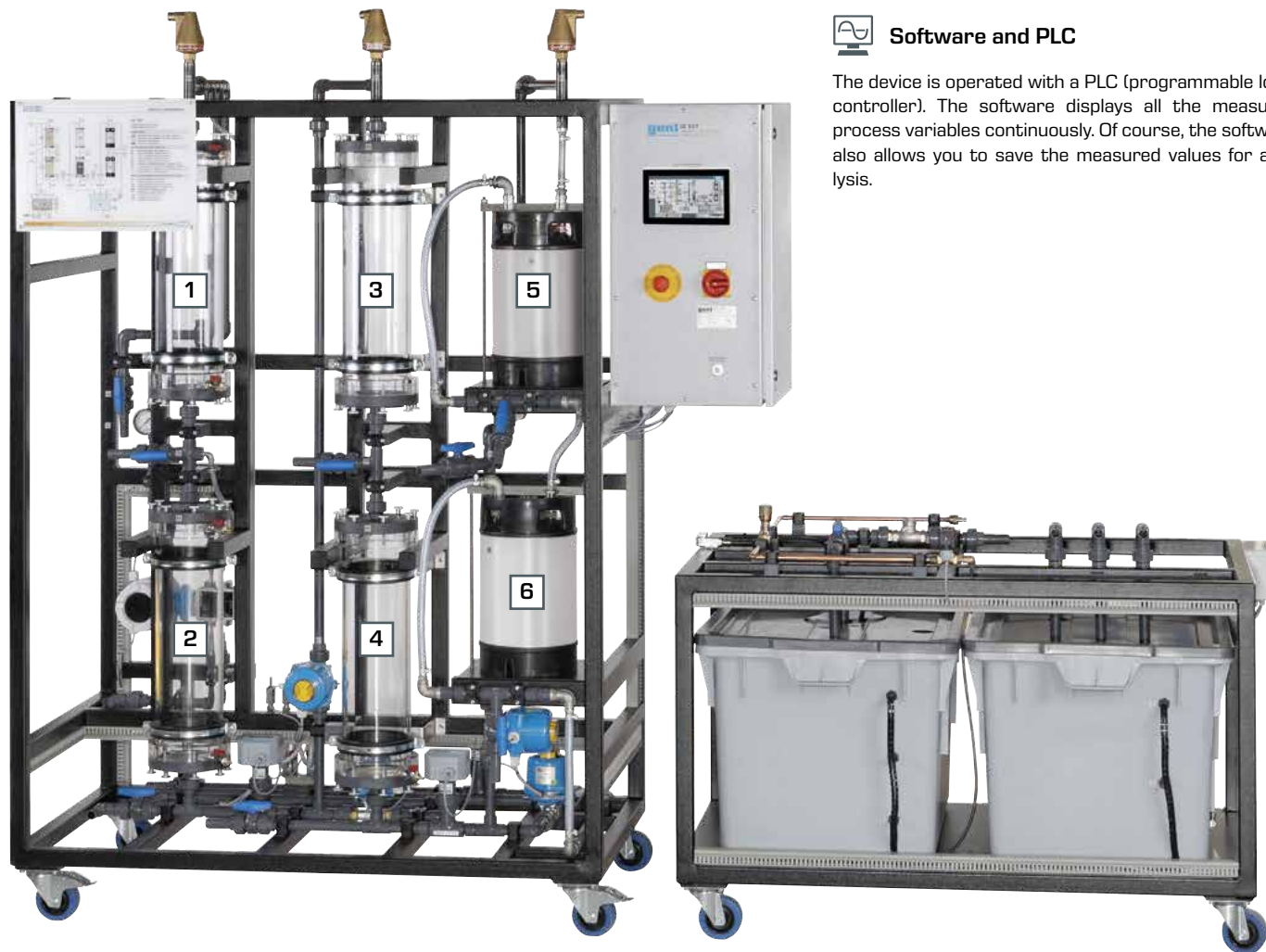

Operating variants

The individual process steps can be enabled or disabled separately. By adjusting electrically driven ball valves, you can choose between the following 3 operating variants:

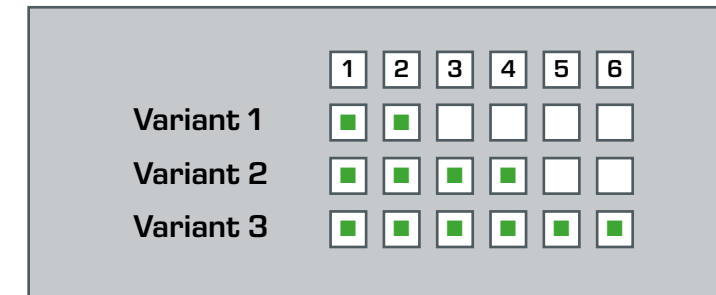

Learning objectives

- learning the fundamental principle of the unit operations depth filtration, adsorption and ion exchange
- observation and determination of the pressure loss in depth filtration
- plotting of breakthrough curves (adsorption)
- comparison of various adsorption materials
- familiarisation with the fundamental principle of ion exchange

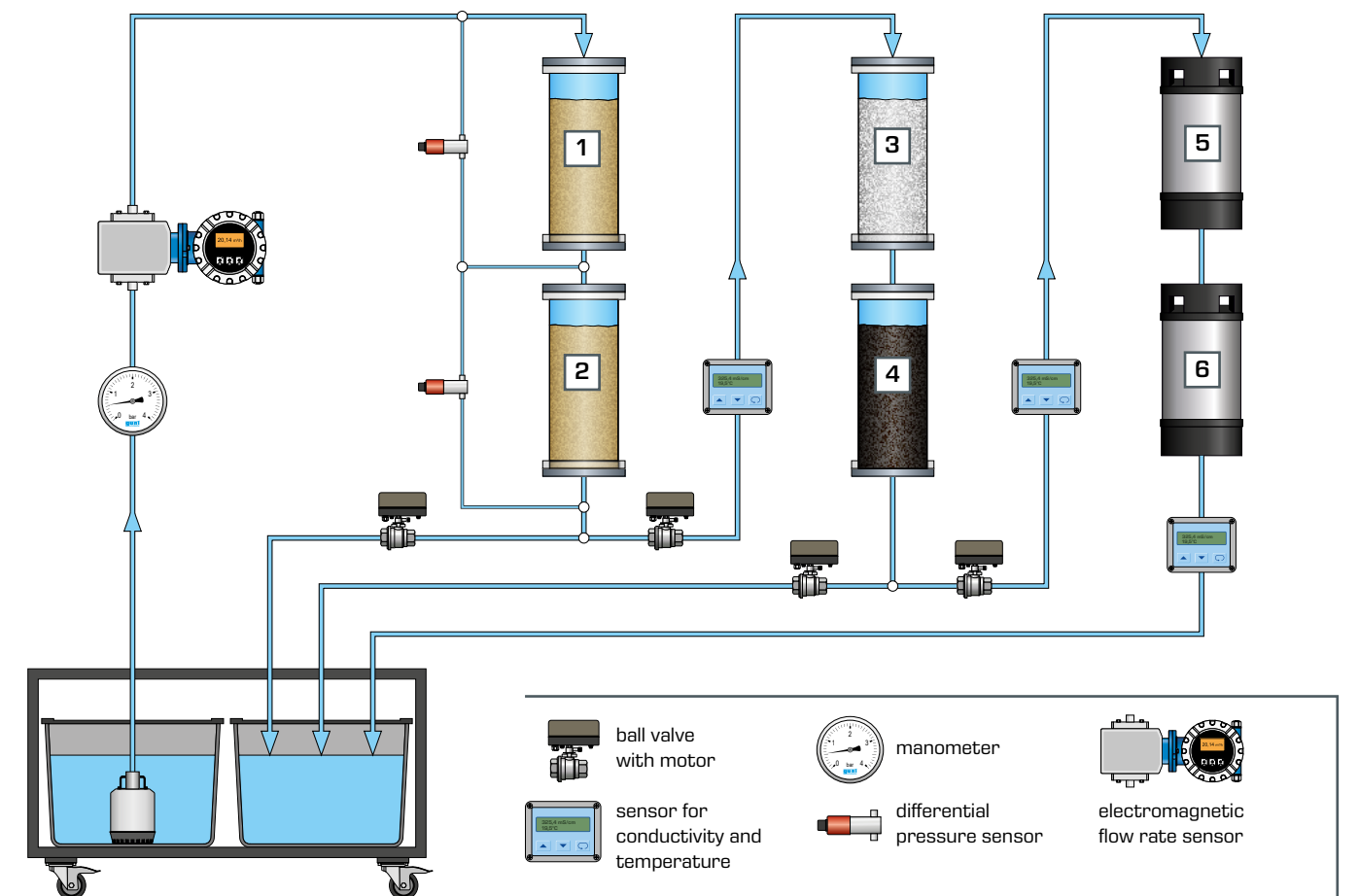

About the product:





CE 582

Water treatment plant 2

Water treatment with sand filter and ion exchanger

This device allows you to clearly demonstrate and investigate the features of multistage water treatment. A sand filter and two ion exchangers are available for this purpose.

With the sand filter the didactic focus is the investigation of the pressure ratios in the filter bed. In order to measure the pressures, the sand filter is fitted with differential pressure measurement and a number of individual measuring points along the filter bed. These measurement points can be connected to a manometer panel, enabling you to measure the

pressure conditions in the filter bed very accurately. The manometer panel has 20 separate tube manometers. By using a transparent filter tube, you can also observe the increased loading of the filter bed visually. The sand filter can be rinsed back if necessary.

Ion exchange takes place after filtration. A cation exchanger and an anion exchanger are available for this purpose. The device also allows for regeneration of the ion exchanger.



Developed in collaboration with the University of Magdeburg (Germany)

- 1 manometer panel
- 2 sand filter
- 3 ion exchanger
- 4 storage tank for regeneration agent
- 5 tank for raw water and treated water
- 6 backwash pump

About the product:

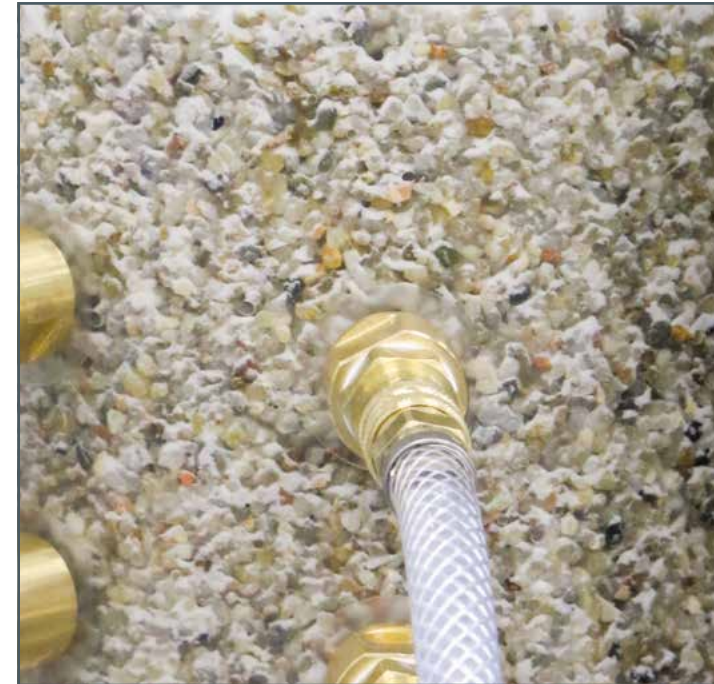

By using a transparent filter tube, you can also observe the increased loading of the filter bed visually as well as using the rise in pressure loss.



Standard at GUNT: use of professional instrumentation

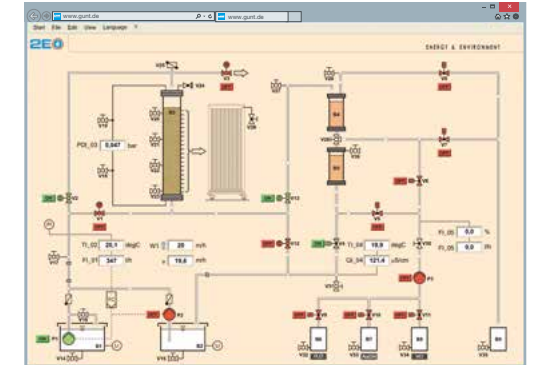

Software

The device is equipped with extensive instrumentation. The device is operated with modern and clearly-arranged software. The software displays all measured process variables continuously. Of course, the software also allows you to save the measured values for analysis.

Learning objectives

- observation and determination of pressure losses in a sand filter
- plotting of Micheau diagrams
- backwash of sand filters
- modes of operation of cation and anion exchangers
- regeneration of ion exchangers

The complete GUNT programme



Engineering mechanics and engineering design

- statics
- strength of materials
- dynamics
- machine dynamics
- engineering design
- materials testing

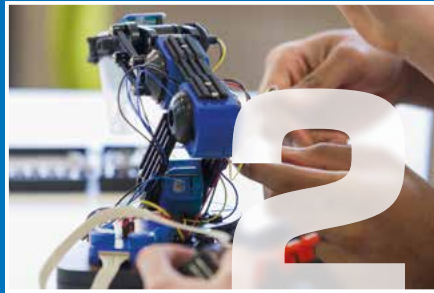

Mechatronics

- engineering drawing
- cutaway models
- dimensional metrology
- fasteners and machine parts
- manufacturing engineering
- assembly projects
- maintenance
- machinery diagnosis
- automation and process control engineering



Thermal engineering

- fundamentals of thermodynamics
- heat exchangers
- thermal fluid energy machines
- internal combustion engines
- refrigeration
- HVAC



Fluid mechanics

- steady flow
- transient flow
- flow around bodies
- components in piping systems and plant design
- turbomachines
- positive displacement machines
- hydraulic engineering



Process engineering

- mechanical process engineering
- thermal process engineering
- chemical process engineering
- biological process engineering
- water treatment



2E Energy & Environment

- | Energy | Environment |
|----------------------------------|-------------|
| ■ solar energy | ■ water |
| ■ hydropower and ocean energy | ■ air |
| ■ wind power | ■ soil |
| ■ biomass | ■ waste |
| ■ geothermal energy | |
| ■ energy systems | |
| ■ energy efficiency in buildings | |

Contact

G.U.N.T. Gerätebau GmbH
Hanskampring 15-17
22885 Barsbuettel
Germany

+49 40670854-0
sales@gunt.de
www.gunt.de



Visit our website
www.gunt.de