

Distribution System Water Quality Monitoring: Sensor Technology Evaluation Methodology and Results

**A Guide for Sensor Manufacturers and
Water Utilities**



**Distribution System Water Quality Monitoring:
Sensor Technology Evaluation Methodology and Results**

A Guide for
Sensor Manufacturers and Water Utilities

John S. Hall
Jeffrey G. Szabo
Water Infrastructure Protection Division
National Homeland Security Research Center

Srinivas Panguluri
Greg Meiners
Shaw Environmental & Infrastructure, Inc.
Cincinnati, Ohio

U.S. Environmental Protection Agency

Office of Research and Development
Water Infrastructure Protection Division
National Homeland Security Research Center
Cincinnati, Ohio



Recycled/Recyclable
Printed with vegetable-based ink on
paper that contains a minimum of
50% post-consumer fiber content
processed chlorine free

Disclaimer

The U.S. Environmental Protection Agency (EPA) through its Office of Research and Development funded and managed the research described herein under Contract Nos. EP-C-04-034 and EP-C-09-041 with Shaw Environmental & Infrastructure, Inc. This document has been reviewed by the Agency but does not necessarily reflect the Agency's views. No official endorsement should be inferred. The U.S. Environmental Protection Agency does not endorse the purchase or sale of any commercial products or services.

Foreword

The U.S. Environmental Protection Agency is charged by Congress with protecting the nation's air, water, and land resources. Under a mandate of national environmental laws, the Agency strives to formulate and implement actions leading to a compatible balance between human activities and the ability of natural systems to support and nurture life. To meet this mandate, the Agency's Office of Research and Development provides data and science support that can be used to solve environmental problems and build the scientific knowledge base needed to manage our ecological resources wisely, to understand how pollutants affect our health, and to prevent or reduce environmental risks.

In September 2002, the Agency announced the formation of the National Homeland Security Research Center. The Center is part of the Office of Research and Development; it manages, coordinates, supports, and conducts a variety of research and technical assistance efforts. These efforts are designed to provide appropriate, affordable, effective, and validated technologies and methods for addressing risks posed by chemical, biological, and radiological terrorist attacks. Research focuses on enhancing our ability to detect, respond (through containment, mitigation, and response to public/media), and stabilize (through treatment and decontamination) in the event of such attacks.

The Center's team of scientists and engineers is dedicated to understanding the terrorist threat, communicating the risks, and mitigating the results of attacks. Guided by the roadmap set forth in the Agency's *Homeland Security Strategy*, the Center ensures rapid production and distribution of water security related research products.

The Center created the Water Infrastructure Protection Division to perform research in water protection areas including: Protection and Prevention, Detection, Containment, Decontamination and Water Treatment Mitigation, and Technology Testing and Evaluation. The detection research can be divided into two main categories: 1) support for contamination warning systems for timely detection of contamination events and 2) confirmation of events through sampling and analysis. This document focuses on online detection technologies evaluated at the Agency's Test and Evaluation Facility in Cincinnati, Ohio. Additional information on the Center and its research products can be found at <http://www.epa.gov/nhsr>.



Kim R. Fox, Director
Water Infrastructure Protection Division
National Homeland Security Research Center

Table of Contents

Disclaimer.....	ii
Foreword.....	iii
List of Tables and Figures.....	vii
Acronyms and Abbreviations.....	viii
Acknowledgements.....	x
Notice of Trademarks and Product Names.....	xi
Executive Summary.....	xii
1.0 Introduction.....	1-1
1.1 Background.....	1-1
1.2 Definitions, Representations and Units.....	1-1
1.3 Concept of Operations for Contamination Warning Systems.....	1-2
1.4 Research Overview.....	1-4
1.5 Report Outline.....	1-4
2.0 Online Detection Equipment and Testing.....	2-1
2.1 Description of Testing Apparatus.....	2-1
2.1.1 Recirculating DSS Loop No. 6.....	2-1
2.1.2 Single Pass DSS.....	2-2
2.2 Test Contaminants and Water Matrices.....	2-3
2.2.1 Tested Contaminants.....	2-3
2.2.2 Test Water Matrix.....	2-4
2.3 Water Quality Measurement.....	2-4
2.3.1 Measured Water Quality Parameters.....	2-4
2.3.2 DSS Loop No. 6 Online Instrumentation.....	2-6
2.3.3 Single Pass DSS Online Instrumentation.....	2-6
2.3.4 Single Pass DSS Online Optical Instruments.....	2-7
2.4 Data Collection and Analysis.....	2-7
2.4.1 Data Collection.....	2-7
2.4.2 Data Analysis.....	2-7
2.5 Teaming with EPA's Water Security Initiative.....	2-8
2.6 EPA's Future Water Quality Sensor Research.....	2-8
3.0 Instrument Setup and Data Acquisition.....	3-1
3.1 Site-Specific Requirements.....	3-1
3.1.1 Environmentally Protected Housing.....	3-1
3.1.2 Access for Servicing the Instrumentation.....	3-2
3.1.3 Pressure-controlled Water Supply.....	3-2
3.1.4 Drainage Access.....	3-3
3.1.5 Power Supply and Electrical Protection.....	3-3
3.1.6 Transmission Media Access.....	3-4
3.1.7 Source Water Quality Adjustment.....	3-4
3.1.8 Instrument-Specific Accessories.....	3-4
3.2 Calibration Materials/Reagents and Onsite Accessories.....	3-5
3.3 Data Acquisition System.....	3-5
3.3.1 4 to 20 Milliampere Current Output.....	3-5
3.3.2 Serial Protocols.....	3-6
3.3.3 Data Communication Protocols.....	3-6
3.3.4 SCADA Setup and Poll Rate.....	3-6
3.3.5 Data Marking.....	3-6
3.3.6 Data Transmission and Storage.....	3-6
3.4 Best Practices for Instrument Setup and Data Acquisition.....	3-7

4.0	Testing Procedures and Safety Precautions.....	4-1
4.1	Blank/Control Injection.....	4-1
4.2	Contaminant Injection Procedures.....	4-1
4.2.1	Concentration of the Injected Contaminant.....	4-1
4.2.2	Duration of Injection.....	4-1
4.2.3	Water Main Flow Rate and Injection Rate.....	4-1
4.2.4	Neat Compounds Versus Commercial Off-the-Shelf Products.....	4-2
4.2.5	Wastewater and Ground Water Injections.....	4-2
4.3	Testing and Analytical Confirmation.....	4-2
4.3.1	Testing Confirmation.....	4-2
4.3.2	Analytical Confirmation.....	4-2
4.4	Flushing and Baseline Establishment.....	4-2
4.5	Health and Safety Precautions.....	4-3
4.6	Disposal of Contaminated Water From Test Runs.....	4-4
4.7	Best Practices for Testing and Safety Precautions.....	4-4
5.0	Data Analysis.....	5-1
5.1	Non-Algorithmic Sensor Response Evaluation.....	5-2
5.1.1	Single Pass DSS Data Analysis.....	5-2
5.1.2	Recirculating DSS Loop No. 6 Data Analysis.....	5-3
5.1.3	Edgewood Chemical and Biological Center Test Loop Data Analysis.....	5-5
5.2	Automated Algorithmic Evaluation of Sensor Response.....	5-6
5.3	Data Analysis Best Practices.....	5-8
6.0	Operation, Maintenance and Calibration of Online Instrumentation.....	6-1
6.1	Operation and Maintenance Labor Costs.....	6-1
6.2	Equipment-Specific Maintenance and Consumable Costs.....	6-1
6.3	Total Organic Carbon Instrumentation.....	6-2
6.3.1	Hach astroTOC™ UV Process Total Organic Carbon Analyzer.....	6-2
6.3.2	Sievers® 900 On-Line Total Organic Carbon Analyzer.....	6-2
6.3.3	Spectro::lyzer™/Carbo::lyzer™.....	6-2
6.4	Chlorine Instrumentation.....	6-3
6.4.1	Hach CL-17 Free and Total Chlorine Analyzer.....	6-3
6.4.2	Wallace & Tiernan® Depolox® 3 plus.....	6-3
6.4.3	YSI 6920DW.....	6-3
6.4.4	Analytical Technology, Inc., Model A15/62 Free Chlorine Monitor.....	6-3
6.4.5	Rosemount Analytical Model FCL.....	6-4
6.5	Conductivity Instrumentation.....	6-4
6.6	pH/ Oxygen Reduction Potential Instrumentation.....	6-4
6.7	Turbidity.....	6-4
6.8	Dissolved Oxygen.....	6-5
6.9	Other Conventional Water Quality Parameter/Instrumentation.....	6-5
6.10	Online Optical Instrumentation.....	6-5
6.10.1	FlowCAM®.....	6-5
6.10.2	Hach FilterTrak™ 660 sc Laser Nephelometer and Hach 2200 PCX Particle Counter....	6-5
6.10.3	BioSentry®.....	6-6
6.10.4	Spectro::lyzer™/Carbo::lyzer™.....	6-6
6.10.5	ZAPS MP-1.....	6-6
6.11	Best Practices and Lessons Learned.....	6-7
7.0	Bibliography.....	7-1

List of Tables

Table 2.1	Test Contaminant Matrix.....	2-4
Table 2.2	Measured Water Quality Parameters	2-5
Table 5.1	Parameter-Specific Significant Change Thresholds	5-1
Table 5.2	Percent Change in Sensor Parameter Response to Injected Chemical Contaminants in Chlorinated Water – Single Pass DSS	5-2
Table 5.3	Normalized, Signal-to-Noise Corrected Sensor Parameter Response to Injected Chemical Contaminants in Chlorinated Water – Single Pass DSS	5-3
Table 5.4	Percent Change in Sensor Parameter Response to Injected Biological Contaminants and Growth Media in Chlorinated Water – Single Pass DSS	5-4
Table 5.5	Normalized, Signal-to-Noise Corrected Sensor Parameter Response to Injected Biological Contaminants and Growth Media in Chlorinated Water – Single Pass DSS	5-4
Table 5.6	Percent Change in Sensor Parameter Response to <i>Bacillus globigii</i> Injection in Chlorinated Water – Single Pass DSS.....	5-4
Table 5.7	Normalized, Signal-to-Noise Corrected Sensor Parameter Response to <i>Bacillus globigii</i> Injection in Chlorinated Water – Single Pass DSS	5-4
Table 5.8	Quantitative Sensor Parameter Response Matrix to Contaminants in Chloraminated Cincinnati Tap Water.....	5-5
Table 5.9	Percent Change in Sensor Parameter Response to Injected Warfare Agents in Chlorinated Water – Edgewood Chemical and Biological Center Test Loop	5-6
Table 5.10	Normalized, Signal-to-Noise Corrected Sensor Parameter Response to Injected Warfare Agents in Chlorinated Water – Edgewood Chemical and Biological Center Test Loop	5-6

List of Figures

Figure 1.1	Architecture of the EPA Contamination Warning System (EPA, 2007a).....	1-3
Figure 2.1	Schematic of DSS Loop No. 6.....	2-1
Figure 2.2	DSS Loop No. 6 Sensor Manifold and Instrumentation Rack.....	2-2
Figure 2.3	Schematic of Single Pass DSS	2-3
Figure 2.4	Single Pass DSS – Longitudinal View	2-3
Figure 2.5	Single Pass DSS – Connecting Pipe Elbows	2-3
Figure 2.6	Single Pass DSS – Sampling Ports.....	2-3
Figure 2.7	DSS Loop No. 6 - Online Instrumentation	2-6
Figure 2.8	Single Pass DSS Instrument Panels	2-7
Figure 2.9	Various Single Pass DSS Optical Instruments	2-7
Figure 2.10	Technical Associates Radiation Monitoring Device	2-7
Figure 2.11	NexSens iSIC Data Acquisition System	2-8
Figure 2.12	First Pilot Utility - Water Security Initiative Instrument Panel Type A	2-8
Figure 2.13	First Pilot Utility - Water Security Initiative Instrument Panel Type B	2-8
Figure 3.1	Single Pass DSS Instrument Panel at 80-foot Sampling Location	3-2
Figure 3.2	Single Pass DSS Instrument Panel at 1,180-foot Sampling Location	3-2
Figure 3.3	Example Constant Head Mechanism for Hach 2200 PCX Particle Counter.....	3-3
Figure 3.4	Field Communications Enclosure.....	3-3
Figure 3.5	Hach astroTOC™ UV Process Total Organic Carbon Analyzer.....	3-4
Figure 3.6	Sievers® 900 On-Line Total Organic Carbon Analyzer.....	3-5
Figure 3.7	SCADA Data Flow Schematic	3-5
Figure 3.8	T&E Facility NexSens iSIC Datalogger	3-7
Figure 4.1	Injection Apparatus for the Single Pass DSS	4-1
Figure 4.2	Glyphosate Triplicate Injection Run Results	4-3
Figure 4.3	Glyphosate Injections at Varying Concentrations	4-3
Figure 5.1	CANARY Operation Schematic.....	5-7

Acronyms and Abbreviations

µm	Micrometer	HSPD	Homeland Security Presidential Directive
µS/cm	Microsiemens/centimeter	I/O	Input and Output
°C	Degrees Centigrade or Celsius	ICR	Inorganic Carbon Remover
°F	Degrees Fahrenheit	IDLH	Immediately Dangerous to Life or Health
AC	Absolute Change	IEC	International Electrotechnical Commission
ANL	Argonne National Laboratory	IP	Internet Protocol
AWWA	American Water Works Association	ISE	Ion Selective Electrode
AwwaRF	American Water Works Association Research Foundation	iSIC	Intelligent Sensor Interface and Control
BOD	Biological Oxygen Demand	KCN	Potassium cyanide
Cl ⁻	Chloride ion	KHP	Potassium hydrogen phthalate
CL ₂	Chlorine	mA	Milliamperes
CO ₂	Carbon dioxide	MALS	Multi-Angle Light Scattering
CWS	Contamination Warning System	MCL	Maximum contaminant level
DCE	Data Circuit-Terminating Equipment	mg/L	Milligrams per liter
DCS	Digital Control Systems	min	Minutes
DMSO	Dimethyl sulfoxide	mL	Milliliter
DO	Dissolved Oxygen	mm	Millimeter
DOC	Dissolved Organic Carbon	mNTU	Milli-Nephelometric Turbidity Unit
DSS	Distribution System Simulator	MSD	Metropolitan Sewer District
DTE	Data Terminal Equipment	MS2	Male-specific 2
ECBC	Edgewood Chemical and Biological Center	mV	Millivolts
EDS	Event Detection Software	N/A	Not available or not applicable
EIA	Electronic Industries Alliance	NAREL	National Air and Radiation Environmental Laboratory
EPA	U.S. Environmental Protection Agency	NEMA	National Electrical Manufacturers Association
eq.	Equivalent	NH ₂ Cl	Chloramine (monochloramine)
ETV	Environmental Technology Verification	NHSRC	National Homeland Security Research Center
ft/sec	Foot per second	nm	Nanometers
FTI	Frontier Technology, Inc.	NTU	Nephelometric Turbidity Unit
GAC	Granular activated carbon	O ₂	Oxygen
GB	G-type Nerve Agent (Sarin or isopropyl methylphosphonofluoridate)	O&M	Operation and Maintenance
GCWW	Greater Cincinnati Water Works	OCL ⁻	Hypochlorite ion
gpm	Gallons per minute	ODBC	Open Database Connectivity
H ⁺	Hydrogen ion (a proton)	OGWDW	Office of Ground Water and Drinking Water
HASP	Health and Safety Plan	ORP	Oxidation Reduction Potential
HMI	Human-Machine Interface	PC	Personal Computer
HOCL ⁻	Hypochlorous acid		
HPLC	High-Performance (or High-Pressure) Liquid Chromatography		
hr	Hour		

pH	Potential of hydrogen in standard units	WATERS	Water Awareness Technology Evaluation Research and Security
PLC	Programmable Logic Controller	WDMP	Water Distribution Monitoring Panel
ppm	Parts per million	WSD	Water Security Division
QAPP	Quality Assurance Project Plan	WSi	Water Security Initiative
ROC	Receiver Operating Characteristic	XML	eXtensible Markup Language
RP-570	RTU Protocol based on IEC 57 Part 5-1 (present IEC 870) Version 0 or 1	ZAPS	Zero Angle Photon Spectrometer
RS-232	Recommended Standard 232		
RS-485	Recommended Standard 485		
RTUs	Remote Terminal Units		
S_{peak}	Peak sensor value between first in contact of the contaminant with the sensor until 15 minutes after the initial contact		
S_{baseline}	Baseline (mean) sensor value for one hour immediately preceding an injection test		
S/N	Signal-to-Noise		
SCADA	Supervisory Control and Data Acquisition		
SDWA	Safe Drinking Water Act		
Shaw	Shaw Environmental & Infrastructure, Inc.		
SNL	Sandia National Laboratories		
T&E	Test & Evaluation		
TA	Technical Associates		
TCP	Transmission Control Protocol		
TEVA	Threat Ensemble Vulnerability Assessment		
TEVA-SPOT	Threat Ensemble Vulnerability Assessment - Sensor Placement Optimization Tool		
TOC	Total Organic Carbon		
TTEP	Technology Testing and Evaluation Program		
UC	University of Cincinnati		
UPS	Uninterrupted Power Supply		
U.S.	United States		
USB	Universal Serial Bus		
UV	Ultraviolet		
UV-Vis	Ultraviolet-Visible		
UV ₂₅₄	Ultraviolet 254 nanometer wavelength		
v/v	Volume/Volume Percent		
VX	V-series Nerve Agent (S-[2-(diisopropylamino)ethyl]-O-ethyl methylphosphonothioate)		

Acknowledgements

The principal authors of this document, titled “Distribution System Water Quality Monitoring: Sensor Technology Evaluation Methodology and Results – A Guide for Sensor Manufacturers and Water Utilities,” are Mr. John S. Hall, Dr. Jeffrey G. Szabo, Mr. Srinivas Panguluri, P.E., and Mr. Greg Meiners.

The authors wish to acknowledge the contributions of the following individuals and organizations towards the development and review of this document:

Technical reviews of the document were performed by:

Mr. Steve Allgeier, U.S. Environmental Protection Agency’s Office of Ground Water and Drinking Water

Mr. Stanley States, Pittsburg Water and Sewer Authority

Mr. Alan Roberson, Director of Security and Regulatory Affairs, American Water Works Association

U.S. Environmental Protection Agency National Homeland Security Research Center quality assurance review was performed by:

Ms. Eletha Brady-Roberts, Quality Assurance Manager

Illustrations and publication design were performed by:

Mr. James I. Scott, Shaw Environmental & Infrastructure, Inc.

Cover Photo Credits are as follows:

Unknown Rural Town, West Virginia – photograph from archives of Shaw Environmental & Infrastructure, Inc.

Water Tower, Florence, Kentucky – photograph by Ms. Jennifer Panguluri

Child drinking water from a tap – photograph of Mr. Ravi Panguluri taken by Ms. Jennifer Panguluri

Notice of Trademarks and Product Names

Trademark or Product Name	Manufacturer's Name, City, State	Web Site
1720D Turbidimeter	Hach Company, Loveland, Colorado	http://www.hach.com
Analytical Technology, Inc. Model A15/62 Free Chlorine Monitor	Analytical Technology, Inc., Collegeville, Pennsylvania	http://www.analyticaltechnology.com
BioSentry®	JMAR Technologies, Inc., San Diego, California	http://www.jmar.com
FlowCAM®	Fluid Imaging Technologies, Yarmouth, Maine	http://www.fluidimaging.com
GuardianBlue™ Early Warning System	Hach Company, Loveland, Colorado	http://www.hach.com
H2O Sentinel™	Frontier Technology Inc., Goleta, California	http://www.fti-net.com
Hach 2200 PCX Particle Counter	Hach Company, Loveland, Colorado	http://www.hach.com
Hach astroTOC™ UV Process Total Organic Carbon Analyzer	Hach Company, Loveland, Colorado	http://www.hach.com
Hach CL17 Free Chlorine Analyzer	Hach Company, Loveland, Colorado	http://www.hach.com
Hach CL17 Total Chlorine Analyzer	Hach Company, Loveland, Colorado	http://www.hach.com
Hach Event Monitor™ Trigger System	Hach Company, Loveland, Colorado	http://www.hach.com
Hach FilterTrak™ 660 sc Laser Nephelometer	Hach Company, Loveland, Colorado	http://www.hach.com
Hach/GLI Model C53 Conductivity Analyzer	Hach Company, Loveland, Colorado	http://www.hach.com
Hach/GLI Model P53 pH/ORP Analyzer	Hach Company, Loveland, Colorado	http://www.hach.com
Hach Water Distribution Monitoring Panel (WDMP) sc	Hach Company, Loveland, Colorado	http://www.hach.com
Hydrolab® DS5	Hach Company, Loveland, Colorado	http://www.hach.com
Real Kill®	Realex Corporation, Spectrum Brands, St. Louis, Missouri	http://www.spectrumbrands.com
Rosemount Analytical Model FCL	Emerson Process Management, Irvine, California	http://www.raihome.com
Roundup®	The Scotts Company, LLC or its affiliates, Marysville, Ohio	http://www.scotts.com
Sievers® 900 On-Line Total Organic Carbon Analyzer	GE Analytical Instruments, Boulder, Colorado	http://www.geinstruments.com
Sievers® RL	GE Analytical Instruments, Boulder, Colorado	http://www.geinstruments.com
Six-CENSE™	CENSAR Technologies, Sarasota, Florida	http://www.censar.com
Spectro::lyser™ or Carbo::lyser™	scan Messtechnik GmbH, Vienna, Austria	http://www.s-can.at
SSS-33-5FT	Technical Associates, Canoga Park, California	http://www.tech-associates.com
TROLL® 9000	In-Situ® Inc., Ft. Collins, Colorado	http://www.in-situ.com
Wallace & Tiernan® Depolox® 3 plus	Siemens Water Technologies, Kent, United Kingdom	http://www.wallace-tiernan.com
YSI 6600	YSI Inc., Yellow Springs, Ohio	http://www.ysi.com
YSI 6920DW	YSI Inc., Yellow Springs, Ohio	http://www.ysi.com
ZAPS MP-1	ZAPS Technologies Inc., Corvallis, Oregon	http://www.zapstechnologies.com

Executive Summary

This report, titled “Distribution System Water Quality Monitoring: Sensor Technology Evaluation Methodology and Results – A Guide for Sensor Manufacturers and Water Utilities,” provides an overview of the U.S. Environmental Protection Agency’s (EPA’s) research results from investigating water quality monitoring sensor technologies that might be used to serve as a real-time contamination warning system (CWS) when a contaminant is introduced into a drinking water distribution system. EPA’s concept of CWS for protecting water distribution systems is discussed in Chapter 1.0. A principal component of such a system is online water quality monitoring.

Based on a review of available online water quality monitoring sensor technologies, an early determination was made that it was not technically feasible to accurately identify and quantify the many different types of contaminants that could potentially be introduced into the drinking water supply/distribution system. Furthermore, because online sensor technologies need to be economically suitable for mass deployment within a distribution system, EPA focused its research on identifying sensor technologies that could be used to detect anomalous changes in water quality due to contamination event(s). Once a water quality anomaly is detected, the water utility operator is alerted, and further actions (e.g., sampling and analysis) could be undertaken by the operator to identify and quantify the contaminant if necessary. This report focuses on EPA’s research on pilot-scale evaluations of available online water quality monitoring sensor instrumentation.

This report first describes the testing apparatus (the recirculating Distribution System Simulator (DSS) - Loop No. 6, Single Pass DSS, and the online instrumentation) used for the pilot-scale evaluations at the EPA Test and Evaluation Facility in Cincinnati, Ohio (Chapter 2.0). The instrument setup and data acquisition specifics are described in Chapter 3.0. The detailed testing procedures and safety precautions are described in Chapter 4.0. The data analysis procedures are presented in Chapter 5.0. Operation and maintenance specifics for selected instruments are provided in Chapter 6.0. In addition, each chapter includes a best practices summary at the end with key points that are designed to deliver the “lessons learned” through this research. A bibliography of selected references is included as Chapter 7.0.

1.0 Introduction

The safety of drinking water supplied to the consumers by water treatment plant operators is dependent upon many factors: quality of raw water (surface water and/or ground water), application of appropriate treatment technology/disinfection (as needed), and monitoring of treated/finished water within the water distribution system network. Appropriate treatment/disinfection technologies for both surface and ground water sources are identified by the U.S. Environmental Protection Agency (EPA) in various regulations that were promulgated pursuant to the Safe Drinking Water Act (SDWA) of 1974 and its amendments. Although the treated water leaving a treatment plant typically meets EPA's water quality requirements, the water could undergo transformation within the various distribution system components (e.g., storage tanks and pipes), which alters the quality, potentially making it unsuitable for human consumption. To address these issues, EPA has developed specific regulations that mandate periodic monitoring of water quality within distribution systems.

Research related to water quality monitoring within the distribution system has increased significantly since the events of September 11, 2001, when improving the security of our nation's water infrastructure became a major priority. Homeland Security Presidential Directive 7 (HSPD-7), issued on December 17, 2003, established a national policy for federal departments and agencies to identify and prioritize United States critical infrastructure and to protect the infrastructure from terrorist attacks. Thereafter, HSPD-9, issued on January 30, 2004, directed EPA to "develop robust, comprehensive, and fully coordinated surveillance and monitoring systems, ... that provide early detection and awareness of disease, pest, or poisonous agents." EPA plays a critical role in this effort as the lead federal agency for water security. Subsequent to these directives, in March 2004, EPA released the peer-reviewed *Water Security Research and Technical Support Action Plan* (Action Plan – EPA, 2004a), which identified important water security related issues and outlined research and technical support needs to address these issues. In addition, the EPA Action Plan identified a list of projects to be undertaken in response to the identified needs. Furthermore, the Action Plan identified several products proposed to be developed to enhance the security of drinking water and wastewater systems. This report is one of the products designed to meet the Action Plan requirements specified under Section 3.3.d.2 – Standard Operating Procedures and Quality Assurance and Control Practices to Guide the Evaluation of Monitor-

ing Technologies and Section 3.3.d.5 – Standard Operating Procedures for Evaluating Monitoring Technologies.

1.1 Background

The analytical methods and water quality sensors used to address EPA regulations pursuant to SDWA were not designed to address water security threats. Consequently, data necessary to identify a serious threat to the water supply caused by either an accidental release or by an intentional act might not be captured during routine periodic monitoring at drinking water treatment plants and various distribution system locations. Over the past five years, as part of the overall Water Awareness Technology Evaluation Research and Security (WATERS) program at the EPA Test & Evaluation (T&E) Facility in Cincinnati, Ohio, EPA investigated online water quality monitoring technologies that might be used to achieve the goal of serving as early warning indicators to detect contaminant introduction into the drinking water supply. The WATERS program testing efforts were sponsored by EPA's National Homeland Security Research Center (NHSRC). During this study, a variety of commercially available online sensors/instruments were evaluated.

Based on a review of available online water quality monitoring sensor technologies, an early determination was made that it was not technically feasible to accurately identify and quantify the many different types of contaminants that could potentially be introduced into a drinking water supply/distribution system. Furthermore, these online technologies needed to be economically suitable for mass deployment within a distribution system. Therefore, EPA focused its research to identify online sensor technologies that could be used to detect anomalous changes in the baseline water quality without specific regard to precision, accuracy or identification of the contaminant. Once an anomaly is detected and the water utility operator is alerted, further actions (e.g., grab sampling and analysis) could be undertaken by the operator to identify and quantify the contaminant whenever possible. This report focuses on EPA's research on pilot-scale evaluations of available online water quality monitoring sensor instrumentation.

1.2 Definitions, Representations and Units

For the purposes of this document, a "sensor" is defined as an electro-mechanical device (e.g., membrane, electrode, or microchip) that measures a physical or chemical characteristic of water and converts it into a "signal" or measured value, which is typically processed further by an instrument.

An instrument is defined as an electro-mechanical device (or a collection of electro-mechanical devices) that can manipulate (e.g., amplify) a measured output from an associated “sensor” and transmit the measured value (e.g., analog or digital output value) to a data acquisition system.

Some instruments (e.g., optical instruments) perform measurements without an associated sensing element (as defined in this section) and contain additional devices that transmit data. Therefore, in general, an instrument is meant to refer collectively to a sensor that provides the overall measurement functionality. Furthermore, a “sensor” or “instrument” response is intended to define the change in measured or recorded output value of the relevant water quality parameter. The term “equipment” is used to refer collectively to electro-mechanical devices that might include one or more sensors, instruments, and additional appurtenances such as plumbing, data collection and/or recording devices that are necessary to make the overall manufactured device functional. Depending upon the focus of the discussion, and to improve document readability, the terms “sensor,” “instrument,” and “equipment” have been used somewhat interchangeably throughout the document.

The research did not address instrument-specific precision, accuracy, or ability to identify contaminants.

The term “sensor manufacturer(s)” is intended to include instrument manufacturer(s) and vendor(s) who might simply resell or repackage a manufactured product. A listing of tested sensor/instrument technologies and their associated registered or unregistered trademarks is included under the Notice of Trademarks and Product Names (page xi) in this report. The tested equipment referred to in this document was procured over time and used for testing during the period of 2003 to 2008. Subsequent to the testing, there could have been design changes and/or improvements to the equipment by the manufacturers. These devices might perform differently under the same tested conditions, but could bear the same registered or unregistered trademark.

Neither the authors nor EPA make any representations on the usefulness or general performance of these devices outside the context of the testing described in this report. The use of these manufacturer-specific names and model numbers throughout the document is to promote clarity so that the reader can identify the tested equipment. Any rights associated with these registered or unregistered trademarks are the sole property of the trademark holders. It is recommended that water utilities and other researchers apply their own judgment prior to choosing any equipment for water quality monitoring.

English standard units that are commonly used by the

U.S. water utility personnel have been used throughout this document. For example, volume is reported in U.S. gallons and velocity in feet per second (ft/s). However, in keeping with industry usage, contaminant concentrations are reported in metric units, in milligrams per liter (mg/L). Unless otherwise stated for computational purposes, the values from the instruments are presented as reported in the output from the individual instrument(s) without any conversions provided.

1.3 Concept of Operations for Contamination Warning Systems

Real-time water quality monitoring to control treatment process operations has been successfully performed at water treatment plants for many years. EPA’s concept for contamination warning systems (CWS) is designed to extend this monitoring approach to multiple locations within a water distribution system (Kessler et al., 1998; ISLI, 1999; AwwaRF, 2002; Kirmeyer et al., 2002; EPA, 2005 a-d; Roberson and Morley, 2005; Allgeier et al., 2006; Dawsey et al., 2006). Consequently, baseline water quality conditions can be monitored continuously in real-time such that a sudden change in water quality parameter(s) can trigger a contamination warning. Monitoring baseline water quality parameters within the distribution system will also provide multiple benefits of improved water quality closer to the point-of-use and additional security for detecting intentional or unintentional contamination events within the system. The capital, operational, and maintenance costs for CWS will be difficult to sustain unless multiple benefits are identified. For water utilities, it is important to first maximize the security benefits by strategically placing the selected online monitors in the network and utilizing suitable techniques to evaluate the online sensor responses. Therefore, in addition to evaluating online water quality monitoring and sensor technologies, EPA has collaborated with various research entities to develop two key software tools that provide these functionalities, described below.

EPA, in collaboration with research organizations including the Sandia National Laboratories (SNL), Argonne National Laboratory (ANL), University of Cincinnati (UC) and the American Water Works Association (AWWA), has developed a software program referred to as the Threat Ensemble Vulnerability Assessment - Sensor Placement Optimization Tool (TEVA-SPOT). TEVA-SPOT can be used to determine the optimum number and locations for monitoring stations within a water distribution system. The software allows the user to specify a wide range of performance objectives including: 1) Population-based health measures, 2) Time to detection, 3) Extent of contamination, 4)

Volume of contaminated water consumed, and 5) Number of contamination events detected. TEVA-SPOT facilitates interactive design of a water quality monitoring system by allowing the user to specify constraints to ensure that the performance objective is satisfied. For example, a TEVA-SPOT user can integrate expert knowledge during the design process by identifying either existing or unfeasible sensor locations. Installation and maintenance costs for sensor placement can also be factored into the analysis. More information on the TEVA Research Program and SPOT can be obtained online at: <http://www.epa.gov/nhsrc/water/teva.html>.

EPA, in collaboration with SNL, also developed the CANARY algorithm to evaluate water quality sensor responses and identify changes in water quality that could indicate a contamination event. The name CANARY is not an acronym, but suggests a parallel with the historic “canary in the coal mine” event detection approach in which the coal miners used canaries to detect poison gas events. Similarly, the CANARY software evaluates real-time water quality data obtained from various instruments and uses mathematical and statistical techniques to identify the onset of anomalous water quality events. The CANARY software allows for the following: 1) the use of a standard data format for input and output of water quality and operations data, 2) the ability to select different detection algorithms (the program contains three different mathematical approaches for analyzing the data), 3) the ability to select various water utility and location-specific configuration options, 4) an online operations mode and an off-line evaluation/training mode, and 5) the ability to generate data needed to establish performance metrics (e.g., false alarm rates). This algorithmic approach enhances the detection sensitivity of the field equipment and simultaneously reduces the false

positive alarm events. CANARY is freely available for download through the EPA website. More information on CANARY can be obtained online at: <http://www.epa.gov/nhsrc/water/teva.html>.

Regardless of the approach used by the utility to evaluate the data collected from online sensors, establishing a protocol to verify and respond to alarms triggered by the online water quality monitoring instruments is important. Note that online water quality monitoring represents only one component of a holistic CWS. Additional data inputs from the utility and public health agencies should be collected and evaluated to complement the benefits of online water quality monitoring (See Figure 1.1).

EPA’s Office of Ground Water and Drinking Water (OGWDW), Water Security Division (WSD), has field-deployed a pilot project called the Water Security Initiative (WSi), that is based upon the concepts identified in Figure 1.1. The WSi program is being implemented in the following three phases:

- Phase I: develop the conceptual design of a system for timely detection and appropriate response to drinking water contamination incidents to mitigate public health and economic impacts;
- Phase II: test and demonstrate CWS through pilots at drinking water utilities and municipalities and make refinements to the design based upon pilot results; and
- Phase III: develop practical guidance and outreach to promote voluntary national adoption of effective and sustainable drinking water CWS.

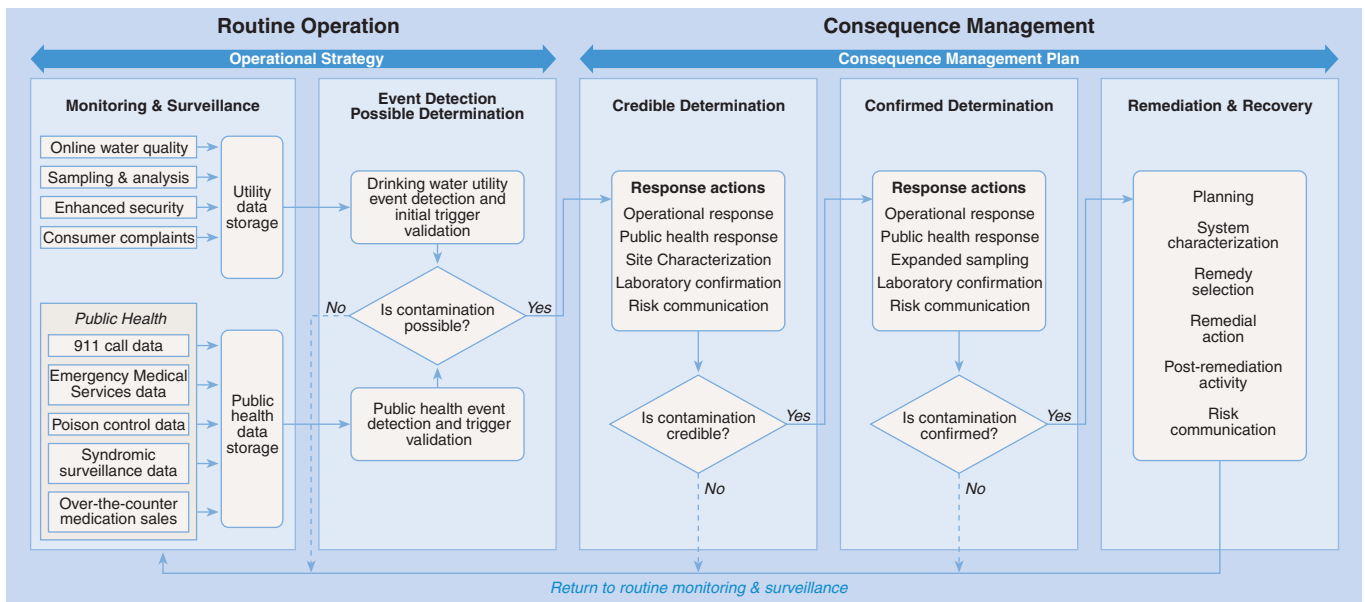

Figure 1.1 Architecture of the EPA Contamination Warning System (EPA, 2007a)



Water Utilities and Sensor Manufacturers

- Online water quality monitoring alone will not provide a holistic CWS.
- Integration of data streams such as consumer complaint surveillance, enhanced security monitoring, public health surveillance, and triggered sampling and analysis with the online water quality monitoring is necessary for realizing the full benefits from a CWS.
- EPA has developed several guidance and guideline documents, a modular response protocol toolbox, and other software tools for utilities planning to establish a comprehensive CWS. The relevant software tools include TEVA-SPOT for locating online sensors and CANARY event detection software. The bibliography section includes a listing of the related EPA documents.
- Manufacturers should design flexibility into the sensor equipment to output real-time data streams in a variety of formats, which allows for analysis by both external and/or internal event detection algorithms.
- In addition to helping achieve regulatory compliance (e.g., monitoring residual disinfectant levels), sustainable online CWS equipment can provide other benefits that can lead to improvements in: distribution system water quality; treatment process control; distribution system control; customer service; and overall security.

Based on information collected from the ongoing Phase I and Phase II activities, WSD has developed a variety of guidance and interim guidance documents on related topics including: WaterSentinel system architecture (EPA, 2005c), planning for CWS deployment (EPA, 2007b), developing an operational strategy for CWS (EPA, 2008a), developing consequence management plans (EPA, 2008b), and the Cincinnati pilot post-implementation system status (EPA, 2008c). In addition, WSD had previously developed a modular response protocol toolbox to assist water utilities for planning and responding to contamination threats (EPA, 2004[c through j]). More information on the EPA WSi can be obtained online at: <http://www.epa.gov/watersecurity>.

1.4 Research Overview

The vast majority of the research described in this report was conducted at the EPA T&E Facility in Cincinnati, Ohio. Since the early 1990's, at this facility, EPA has conducted research using simulated drinking water distribution systems. A number of pilot-scale distribution system simulators (DSSs) are in use at the T&E Fa-

cility. EPA operates, maintains, and modifies the DSSs as needed to accommodate evolving study designs. For the research results reported in this document, EPA employed two types of DSSs at the T&E Facility to investigate water quality monitoring sensor technologies that might be used to serve as a real-time early warning system when a contaminant is introduced into the drinking water supply. Only online sensors were evaluated, because the response time is critical for achieving the project objective of contamination warning.

To evaluate the selected sensors, a series of test runs was conducted by injecting known quantities of potential contaminants into the selected DSSs. After injection, sensor data were collected continuously and electronically archived. After injection, grab samples were collected periodically to confirm the sensor results. These studies were focused on providing independent third party data to decision makers in the following areas:

1. What water quality parameters will be most useful in CWS?
2. Can online water quality sensors be used to reliably trigger alarms in response to contamination events within a water distribution system?
3. What are the operational and maintenance costs associated with online water quality monitoring systems?

1.5 Report Outline

The following chapters of this report summarize the findings related to this research. Chapter 2.0 presents a summary of the various online detection sensors/instrumentation evaluated and the evaluation-specific research activities performed at the EPA T&E Facility in Cincinnati, Ohio and other field locations. Chapter 3.0 describes general instrument setup and data acquisition. Chapter 4.0 contains a description of the testing procedures and safety precautions. Chapter 5.0 outlines the data analysis procedures. Chapter 6.0 describes the operation and maintenance (O&M) and calibration requirements of the tested instrumentation. At the end of each chapter (starting in Chapter 3.0), a summary of applicable best practices is presented for the targeted audience, which includes sensor manufacturers and water utilities.

2.0 Online Detection Equipment and Testing

The focus of this research was to identify water quality parameters and online sensor technologies that could be used to detect anomalous changes in water quality due to contamination event(s) within a water distribution system. The sections of this chapter briefly describe the following: testing apparatus, contaminants and injected concentrations, disinfectants, water quality parameters and online instrumentation, data collection and analysis, event detection, and field applications.

2.1 Description of Testing Apparatus

The first round of testing for online water quality sensor instrumentation was conducted using recirculating DSS Loop No. 6 located at the T&E Facility in Cincinnati, Ohio. DSS Loop No. 6 was essentially operated as a closed system during the sensor testing period. At the conclusion of the first round of tests, some of the research stakeholders expressed concern that the recirculation mode operation of DSS Loop No. 6 enhanced the detection ability of the sensors. In this mode, the contaminant is recirculated within the distribution system, thereby allowing the sensor to detect the same slug of contaminant multiple times. Subsequently, later rounds of testing involved the use

of the Single Pass DSS, also located at the T&E Facility in Cincinnati, Ohio.

Concurrent to the DSS Loop No. 6 and Single Pass DSS testing, EPA conducted a series of bench-scale minimum dosing tests. In these tests, the selected contaminants in a water matrix (at various concentrations) were exposed to the online sensors to establish the minimum dosage/concentration of the contaminant where a “response” to various water quality parameters was produced by the sensor instrumentation.

2.1.1 Recirculating DSS Loop No. 6

Recirculating DSS Loop No. 6 consists of a 15-year old, 6-inch-diameter unlined ductile iron pipe and is one of six pipe loops within the DSS (Loop Nos. 1 through 6). DSS Loop No. 6 is approximately 75 feet long and has a total capacity of approximately 150 gallons. DSS Loop No. 6 is equipped with a 3-horsepower pump capable of circulating water through the loop at a rate of up to 110 gallons per minute (gpm). The loop is normally operated at a flow rate of 88 gpm, which produces a velocity of 1 foot per second (ft/sec) in the main pipe. The process flow schematic of the DSS Loop No. 6 used for these tests (including modifications for this research) is presented in Figure 2.1.

For the purposes of this testing, DSS Loop No. 6 was operated in recirculation mode using municipal tap water supplied by the Greater Cincinnati Water Works (GCWW). In this mode, the feed tanks and the 100-gal-

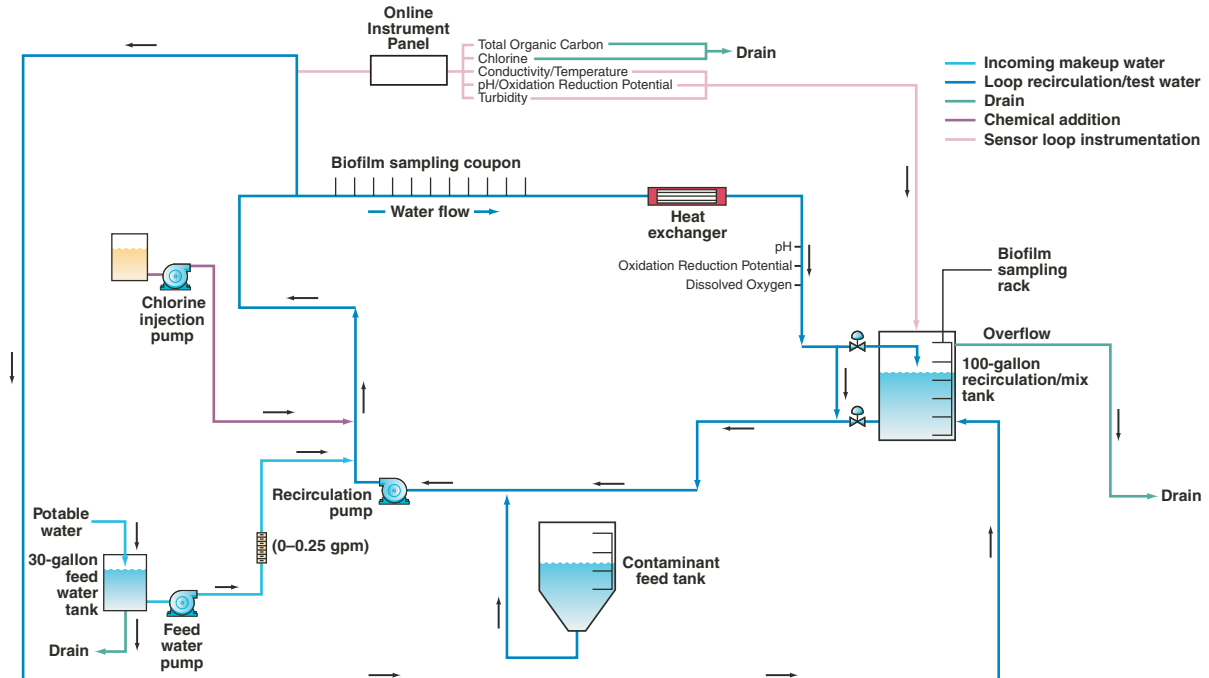

Figure 2.1 Schematic of DSS Loop No. 6

lon recirculation tank are kept inline with the system. Operation in this mode effectively increases the volume of water in the system by 85 gallons, to a total of approximately 235 gallons. When operating in recirculation mode, potable water is added to the system from the 30-gallon feed-water tank at a rate of 0.16 gpm. At this rate, the entire volume of the system is exchanged in 24 hours. However, due to mixing in the recirculation tank, the time required to completely exchange the contents of the system via dilution is considerably longer.

Injected contaminants reached the sensors in approximately 75 seconds and quickly become homogeneously mixed with the 250 gallons of water in the system. Dye tests were performed to confirm the travel time and mixing. The response profiles to injected contaminants reflect this design. An initial response after the contaminant first reaches the sensors is recorded for those sensors capable of detecting the contaminant. The response persists as the contaminant becomes dispersed in the DSS Loop No. 6, and in the sensor manifold, followed by a period of recovery due to dilution or consumption of the injected material via hydrolysis or reaction with free chlorine present in the tap water or through pipe wall reaction.

DSS Loop No. 6 is equipped with one 10-gallon chemical feed tank and a pump used to add treatment chemicals to the system. The feed tank was used to add chlorine when establishing baseline conditions prior to the addition of contaminants. Chlorine additions continued during test runs in order to keep the disinfectant levels stable during injections. The DSS Loop No. 6 setup also allowed for testing using chloramine as the disinfectant.

Two hardware modifications to the flow system of DSS Loop No. 6 were made to support the sensor evaluation studies. A 50-gallon feed tank with a delivery line to the intake side of the recirculation pump was added for the purpose of introducing contaminants into DSS Loop No. 6. Also, a sensor loop manifold (see Figure 2.1 and Figure 2.2) was fabricated for the purpose of diverting water flow from the DSS Loop No. 6 to the online monitors under evaluation, and to collect grab samples for field and laboratory analyses.

DSS Loop No. 6 was equipped with a sensor manifold incorporating the needed online sensors so that the studies could begin quickly. Since DSS Loop No. 6 was operated in essentially a closed mode, the observed sensor responses were typical of a batch reactor operation. Essentially, the sensor response seen for the duration of a test run was similar to the case where a contaminant slug would travel through the system for the entire test duration (assuming minimal dispersion, mixing and general disruption of slug due to flow



Figure 2.2 DSS Loop No. 6 Sensor Manifold and Instrumentation Rack

variations). The recirculation mode within the tank also dilutes the concentration of the contaminant in 24 hours and does not represent a true plug flow system. Because there are some technically valid differences as compared to a “real world” distribution system, the recirculation mode allowed for safer contained tests, eliminated wastage of water, and allowed for easy identification of viable sensors, prior to embarking on studies using the Single Pass DSS as outlined in the next section.

2.1.2 Single Pass DSS

The Single Pass DSS was constructed of 3-inch-diameter glass-lined ductile iron pipe and spans the entire length (150 feet) of the T&E facility high-bay area and wraps back and forth across this expanse eight times. The combined length of this pipe is approximately 1,200 feet and the Single Pass DSS has a total capacity of approximately 440 gallons. The pipe is gravity fed with tap water via a 750-gallon stainless steel tank mounted near the ceiling of the facility. This tank is supplied from a floor-mounted 1,000-gallon stainless steel tank. In-situ chemical feed tanks and mixers can be used for chlorine dosing, chemical addition, or other similar purpose. The contaminant injection port was installed immediately downstream of the 750-gallon feed tank. In addition, two sampling ports were installed at 80-foot and 1,180-foot distances from the contaminant injection port. The two sampling ports supply sample water to multiple instrumentation racks. Figure 2.3 shows a schematic of the Single Pass DSS within the T&E Facility.

Figures 2.4 and 2.5 show the Single Pass DSS running the length of the T&E Facility high bay and wrapping its length 4 times on the east side of the pipe rack. Figure 2.6 shows the sampling ports for the inlet located at the top near the 80-foot mark and the outlet located directly below this port at the 1,180-foot distance.

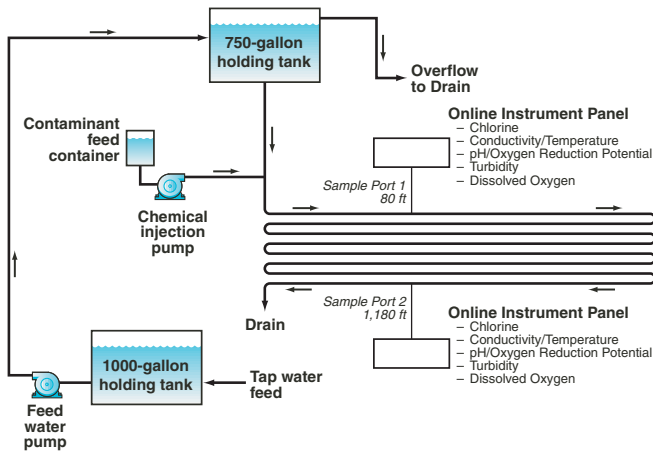

Figure 2.3 Schematic of Single Pass DSS

2.2 Test Contaminants and Water Matrices

Target contaminants for the study were selected to be representative of broad classes of biological and chemical contaminants that could be potentially introduced



Figure 2.4 Single Pass DSS – Longitudinal View



Figure 2.5 Single Pass DSS – Connecting Pipe Elbows



Figure 2.6 Single Pass DSS – Sampling Ports

into the U.S. water supply. Municipal tap water supplied by the GCWW was used as the water matrix for this testing.

2.2.1 Tested Contaminants

Table 2.1 presents a summary of the broad classes of contaminants and specific contaminants tested by EPA along with the associated test water matrix. The online instrumentation used to measure the individual water quality parameter responses during the testing varied due to various logistical reasons and the evolution of the testing activity during the course of the research. For example, most of the advanced optical instruments such as the BioSentry®, FlowCAM®, Spectro::lyser™, and Hach FilterTrak™ 660 sc Laser Nephelometer were not procured prior to beginning testing that utilized the recirculating DSS Loop No. 6. These optical devices were purchased later to evaluate their efficacy in detecting biological contaminants. The BioSentry® and FlowCAM® instruments are designed to count and identify the injected biological cells. Therefore, for the purposes of evaluating these instruments, the following biological contaminants, surrogates, and growth (or carrier) media such as nutrient broths were injected into the Single Pass DSS: three micron beads, *Escherichia coli* (*E. coli*), *E. coli* (in dechlorinated water), bacteriophage male-specific (MS2), *Bacillus globigii* (*B. globigii*), *B. globigii* (in dechlorinated water), secondary effluent from wastewater treatment, sporulation media, sucrose, Terrific Broth, nutrient broth, and Trypticase soy™ broth. The biological contamination tests were performed in three distinct ways: 1) test cells (centrifuged to isolate the contaminant only) injected with tap water, 2) test cells in nutrient or broth solutions, 3) test cells in nutrient and broth solutions preceded by treatment with dechlorinating agents such as sodium thiosulfate pentahydrate and sodium thiosulfate anhydrous. The last test was performed because real-world contamination events might be conducted in conjunction with dechlorination in an attempt to make the cells more

Table 2.1 Test Contaminant Matrix

Contaminant Class	Specific Contaminant	Recirculating Loop		Single Pass
		Cl ₂ ^a	NH ₂ Cl ^b	Cl ₂
Biologicals	<i>Bacillus globigii</i>			X
	Bacteriophage MS2			X
	<i>Escherichia coli</i>	X	X	X
	Surrogate beads			X
Insecticides	Aldicarb			X
	Nicotine		X	X
	Real Kill®/Malathion	X	X	X
	Dichlorvos			X
	Phorate		X	X
Herbicides	Roundup® /Glyphosate	X	X	X
	Dicamba			X
Culture Broths	Nutrient broth			X
	Sporulation media			X
	Terrific broth			X
	Tryptic soy broth			X
Inorganics	Arsenic trioxide			X
	Cesium chloride			X
	Cobalt chloride			X
	Lead nitrate			X
	Mercuric chloride			X
	Potassium cyanide			X
	Potassium ferricyanide	X		X
	Sodium arsenite		X	X
	Sodium thiosulfate			X
	Sodium fluoride			X
Warfare Agents	Ricin	X ^c		
	G-type nerve agent	X ^c		
	V-series nerve agent	X ^c		
	Potassium cyanide	X ^c		X
Others	Blank (GAC water)		X	X
	Secondary effluent	X	X	X
	Colchicine			X
	Dimethyl sulfoxide			X
	Dye	X		X
	Sucrose			X
	Sodium fluoroacetate			X
	Methanol			X

^aChlorine

^bChloramines

^cTesting conducted at the U.S. Army's Aberdeen Proving Ground's Edgewood Chemical Biological Center (ECBC) Facility.

viable. The presence of free chlorine at the typical residual levels [~1 milligrams per liter (mg/L)] is deleterious to many biological organisms and reduces the efficacy of a biological attack. The bacteriophage MS2 tests were performed to simulate a viral threat. To evaluate the impact

of nutrient broth and the dechlorinating agents, the following “control” injections were also performed: sodium thiosulfate pentahydrate, sodium thiosulfate anhydrous, sucrose, terrific broth, and nutrient broth.

2.2.2 Test Water Matrix

The GCWW water supply to the T&E Facility comes from the Miller Plant, which treats water from the Ohio River. GCWW uses chlorine as the residual disinfectant for water distribution. The background range of values for the routinely measured water quality parameters at the T&E Facility are as follows: free chlorine – 0.8 to 1.1 mg/L, specific conductance – 300 to 600 microsiemens per centimeter (µS/cm), oxidation reduction potential (ORP) – 500 to 700 millivolts (mV), potential of hydrogen in standard units (pH) – 8.5 to 8.8, turbidity < 0.1 nephelometric turbidity units (NTU), and total organic carbon (TOC) – 0.3 to 1.3 mg/L. Only the free chlorine levels were adjusted as needed (prior to testing) such that the levels were approximately 1 mg/L.

The chloraminated water was prepared in batches using a 2,400-gallon tank. GCWW-supplied tap water was collected in a 2,400-gallon tank at the EPA T&E Facility and tested for total chlorine residual. Calculations were made to determine the correct amount of sodium hypochlorite necessary to raise the total chlorine concentration to the desired level, usually 2 mg/L. When this concentration was achieved and verified by analysis, ammonium hydroxide was added in sufficient quantity (chlorine to ammonia ratio of 4:1) to convert the free chlorine into combined chlorine. The resulting chloraminated water was mixed for 15 to 20 minutes and retested for both free and total chlorine.

2.3 Water Quality Measurement

Prior to introduction of contaminants, water-quality sensors located within the selected test apparatus (i.e., DSS Loop No. 6 or Single Pass DSS) were typically monitored for an hour to establish normal (baseline) conditions. After contaminant injection, data from the various sensors were monitored and recorded. The sensor data were supported by the analysis of grab samples taken from the test apparatus at discrete intervals. For experimental control, uncontaminated test water matrix was injected into the test apparatus. During the testing, it was verified that the act of injection did not affect baseline conditions as characterized by sensor response.

2.3.1 Measured Water Quality Parameters

A variety of water quality parameters was measured during the testing period. The specific instrumentation used in individual test runs for both DSS Loop No. 6 and the Single Pass DSS was dependent on the availability of instrumentation during the testing period. Table 2.2 presents an overall summary of the

Table 2.2 Measured Water Quality Parameters

Parameter	Measurement Type	Online Instrumentation Tested	Parameter Applicability
Ammonia – nitrogen	Continuous and grab	YSI 6600, YSI 6920DW	Naturally occurring form of nitrogen in the nitrogen cycle. Dissolved ammonia gas is toxic to aquatic life at concentrations as low as 0.2 milligram per liter (mg/L). Will be converted to chloramine in chlorinated drinking water.
Apparent color	Grab	Various laboratory instruments, Six-Cense™	Visible color resulting from turbidity and dissolved materials (humic material, dissolved metals, dyes, algae). Potable water is normally colorless after treatment.
Chloride	Continuous and grab	YSI 6600, YSI 6920DW	Indicator of salinity. Associated with a secondary maximum contaminant level (MCL) of 250 mg/L in drinking water.
Conductivity measured as specific conductance ^a	Continuous and grab	YSI 6600, YSI 6920DW, Hydrolab® DS5, Troll® 9000, Six-Cense™, Hach/GLI Model C53 Conductivity Analyzer	Ability of water to carry an electrical current. Strong indicator of dissolved salts. Serves as a surrogate for total dissolved solids.
Dissolved oxygen (DO)	Continuous and grab	YSI 6600, Hydrolab® DS5, Troll® 9000, Six-Cense™	Concentration of oxygen dissolved in water can serve as an indicator of chemical and biochemical activity in water.
Fluorescence (total, humic and bacterial)	Continuous Spectrophotometric	ZAPS MP-1	Instrumental measure of fluorescence at various wavelengths.
Free chlorine	Continuous and grab	YSI 6920DW, Hydrolab® DS5, Troll® 9000, Six-Cense™, Hach CL17 Free Chlorine Analyzer	Chlorine is added to the DSS ^b in the form of sodium hypochlorite. Chlorine levels in drinking water are controlled at ~1 mg/L.
Multi-angle light scattering (MALS)	Continuous	BioSentry®	Utilizes laser-produced MALS technology to generate unique bio-optical signatures for classification using JMAR's pathogen detection library.
Multi-spectrum (UV-Vis) absorption	Continuous Spectrophotometric	Spectro::lyser™ or Carb::olyser™	UV-Vis excitation that provides a means of estimating absorption at various wavelengths. Nitrate and/or nitrite concentration, DOC ^c , TOC, COD ^d and BOD ^e (depending on the used algorithm), and turbidity. Information at nearly any wavelength between 200 and 750 nm.
Nitrate – nitrogen	Continuous, grab, and spectrophotometric	YSI 6600, YSI 6920DW	Essential nutrient for plants and animals. Nitrate is the most soluble form of nitrogen. Causes health problems in humans. Drinking water standard is 10 mg/L.
Oxidation-reduction potential (ORP)	Continuous and grab	YSI 6600, YSI 6920DW, Hydrolab® DS5, Troll® 9000, Six-Cense™, Hach/GLI Model P53 pH/ORP Analyzer	Indicator of dissolved oxidizing and reducing agents (metal salts, chlorine, sulfite ion). ORP values above 700 millivolts (mV) kill unwanted organisms in drinking water. A ground water incursion may lower ORP by increasing chlorine demand. Chlorination of drinking water produces an ORP background of ~700 millivolts in GCWW water.
Particle Count	Continuous	Hach 2200 PCX Particle Counter	Counts all particles that are between 2 and 750 µm in size. The counted particles can be subdivided into 32 size ranges to identify particles of interest. For example, the particle size ranges could be selected to correspond to biological organisms such as <i>Giardia</i> (6-10 µm) and <i>Cryptosporidium</i> spp. (2-5 µm).
Particle count and image-based identification	Continuous	FlowCAM®	Measures particle size, count and shape. Images particles between 2 µm and 3 mm in size. Helps to identify and classify particles based on library of images.
pH	Continuous and grab	YSI 6600, YSI 6920DW, Hydrolab® DS5, Troll® 9000, Six-Cense™, Hach/GLI Model P53 pH/ORP Analyzer	Indicator of hydrogen ion activity (acidity or alkalinity) of water. Most chemical and biochemical processes are pH dependent. Carbon dioxide/bicarbonate/ carbonate and ammonia/ammonium equilibria are pH dependent. pH of drinking water is well established and controlled. A change of more than 0.5 pH unit indicates a problem.

Table 2.2 (continued) Measured Water Quality Parameters

Parameter	Measurement Type	Online Instrumentation Tested	Usefulness of Parameter for Water Quality
Temperature	Continuous and grab	YSI 6600, YSI 6920DW, Hydrolab® DS5, Troll® 9000, Six-Cense™, Hach/GLI Model C53 Conductivity Analyzer, Hach/GLI Model P53 pH/ORP Analyzer	A measurement indicator of how hot or cold the water is. DO and specific conductance change with temperature. Biological and chemical activities are heavily influenced by water temperature.
Total cyanide, malathion, and glyphosate	Grab	Various laboratory instruments	Compound-specific laboratory analysis for the purpose of determining the fate of these three contaminants in the DSS.
Total organic carbon (TOC)	Continuous and grab	Hach astroTOC™ UV Process Total Organic Carbon Analyzer, Sievers® 900 On-Line Total Organic Carbon Analyzer, Spectro::lyser™ or Carb::olyser™	Dissolved plus particulate organic compounds. Can range from 0.5 to 25 mg/L in drinking water in the U.S. May be correlated to chemical and biological oxygen demand.
Transmission	Continuous Spectrophotometric	ZAPS MP-1, Spectro::lyser™ or Carb::olyser™	Measure of color based on Beer's Law as measured by photon transmission through water [800 nanometers (nm) for this study].
Turbidity	Continuous and grab	YSI 6600, YSI 6920DW, Hydrolab® DS5, Troll® 9000, Six-Cense™, 1720D Turbidimeter, Hach FilterTrak™ 660 sc Laser Nephelometer	Indicator of suspended matter and microscopic organisms. Pathogens are more likely to be present in highly turbid waters.
Ultraviolet 254 nanometer wavelength (UV ₂₅₄) absorption	Continuous Spectrophotometric	ZAPS MP-1, Spectro::lyser™ or Carb::olyser™	Measure of organic compounds that absorb photons at 254 nm. Indicative of organic compounds with aromatic chemical structure and conjugation.

^aSpecific conductance is defined as the raw solution conductivity, compensated to 77°F (25°C).

^bDSS = Distribution System Simulator.

^cDOC = Dissolved Organic Carbon.

^dCOD = Chemical Oxygen Demand.

^eBOD = Biological Oxygen Demand.

measured water quality parameters and a summary of the usefulness of each measurement in terms of water quality.

2.3.2 DSS Loop No. 6 Online Instrumentation

The following are online water quality monitoring sensor instruments that were evaluated during the various DSS Loop No. 6 test runs: YSI 6600, Hydrolab® DS5, Troll® 9000, Six-CENSE™, Hach Water Distribution Monitoring Panel (WDMP), and Zero Angle Photon Spectrometer (ZAPS) MP-1. Figure 2.2 (previously shown) and Figure 2.7 depict most of the online instrumentation evaluated during the DSS Loop No. 6 testing.

2.3.3 Single Pass DSS Online Instrumentation

The following are online water quality monitoring sensor instruments that were evaluated during the various Single Pass DSS test runs: Hach CL17 free chlorine analyzer; Analytical Technology, Inc. Model A15/62 free chlorine monitor; YSI 6920DW;

Wallace & Tiernan® Depolox® 3 plus; Hach astroTOC™ UV process TOC analyzer; Hach WDMP; Sievers® RL; and Sievers® 900 On-Line TOC Analyzer. Figure 2.8 shows two Single Pass DSS instrument panels.



Figure 2.7 DSS Loop No. 6 - Online Instrumentation



Figure 2.8 Single Pass DSS Instrument Panels

2.3.4 Single Pass DSS Online Optical Instruments

The following are online optical instruments that were evaluated during the various Single Pass DSS test runs: Carbo::lyser™ and Spectro::lyser™, BioSentry®, FlowCAM®, Hach FilterTrak™ 660 sc Laser Nephelometer, and Hach 2200 PCX Particle Counter. Figure 2.9 depicts the instrument panel that contains the controller for the Carbo::lyser™, controller for the Hach Filter/Trak™ 660 sc Laser Nephelometer, and the FlowCAM® device.



Figure 2.9 Various Single Pass DSS Optical Instruments

In addition to these instruments, EPA is also evaluating the radiation monitor (Technical Associates, Canoga Park, California) at the National Air and Radiation Environmental Laboratory (NAREL) in Montgomery, Alabama. The results from these tests were not available at the time of production of this document. Figure 2.10 depicts the radiation monitor.

2.4 Data Collection and Analysis

Data collected for each parameter from the online water quality sensor instruments were complemented by laboratory analyses of grab samples. To facilitate com-

parisons between the online monitoring results and laboratory analyses, sensor responses to contaminants for each parameter were plotted along with associated grab sample results. These plots allowed a graphic interpretation of the data to 1) evaluate changes in baseline conditions due to contaminant introduction, 2) compare sensors (using different technologies to measure the same parameter), and 3) recognize false negative/false positive responses by visual comparison to the grab sample data.



Figure 2.10 Technical Associates Radiation Monitoring Device

2.4.1 Data Collection

Wherever possible, each of the online sensors was connected to a data acquisition system. The intelligent Sensor Interface and Control (iSIC) system was connected to the data collection personal computer (PC) via hardwire or radio (as appropriate). The data collection PC ran the iChart software program, which polled the connected iSIC(s) and monitoring devices every 2 minutes and recorded the data reported by the instrumentation. The 2-minute data collection cycle was considered to be optimum because of the number of instruments concurrently tested that needed to be polled for data and the measurement cycle limitations of some tested devices. The iSIC/iChart system was selected as the data collection platform because it incorporated many pre-built device drivers that could communicate with the widest variety of online instrumentation tested at the T&E Facility. A more detailed discussion of the data collection system is presented in Chapter 4.0. Figure 2.11 shows the Nex-Sens iSIC data acquisition system.

2.4.2 Data Analysis

The data plots generated from the tests conducted at the T&E Facility were analyzed visually to construct a qualitative response matrix for the contaminants test-



Figure 2.11 NexSens iSIC Data Acquisition System

ed. The criteria for determining a “significant change” was subjective at the early stages of the research. The sensor responses were plotted over the course of the test runs and analyzed for visually significant changes. Thereafter, a more robust analysis was performed where the absolute change, percent change, and signal-to-noise (S/N) ratio for each measured parameter was computed. See Chapter 5.0 for further details.

At the onset of this testing effort, EPA determined that an automated algorithmic analysis of the online data was essential. Therefore, concurrent to the testing, EPA initiated collaboration with SNL for the development of the CANARY Algorithm (previously described in Chapter 1.0). In addition, EPA continues to evaluate other commercial data analysis algorithms/products as they became available (Umberg et al., 2009).

2.5 Teaming with EPA’s Water Security Initiative

The work conducted at the T&E Facility assisted EPA’s Water Security initiative (WSi – formerly, WaterSentinel). As described in Section 1.2, the EPA’s OGWDW-WSD worked collaboratively with NHSRC to deploy a pilot network of water quality monitoring instrumentation at GCWW as a part of the WSi pilot in Cincinnati (EPA, 2008c). Figures 2.12 and 2.13 show two types of instrument panels deployed at the first pilot utility. The panels contain online instrumentation to measure free chlorine, TOC, pH, ORP, conductivity, temperature and turbidity. The Type A panels utilize all Hach instrumentation, whereas the Type B panels utilize instrumentation from manufacturers other than Hach. As will be discussed in Chapter 5.0, free chlorine and TOC were found to be most useful trigger parameters in chlorinated water systems.

2.6 EPA’s Future Water Quality Sensor Research

EPA, through their Technology Testing and Evaluation Program (TTEP) and testing activities at the T&E Facility, will continue to identify and evaluate promising sensor technologies for potential use in CWS, as funding allows. Radiological and low density biological detection equipment testing are the key current sensor-related data gaps. New technologies are needed to reduce the current capital, operational, and maintenance costs in order for CWS programs to be sustainable. Information on sensor evaluation programs can be obtained by contacting Mr. John Hall via e-mail (Hall.John@epa.gov) or phone (513-487-2814). Additional information related to EPA’s water protection research can be obtained at: <http://www.epa.gov/nhsrc/aboutwater.html>.

WSi is a program designed to address the risk of intentional contamination of drinking water distribution systems. Initiated by OGWDW in response to HSPD-9,



Figure 2.12 First Pilot Utility - Water Security Initiative Instrument Panel Type A



Figure 2.13 First Pilot Utility - Water Security Initiative Instrument Panel Type B



Water Utilities and Sensor Manufacturers

- Online sensors were tested in simulated distribution systems using chlorinated and chloraminated waters. The simulated systems were injected with a variety of target contaminants to evaluate the individual sensor/parameter response.
- Grab sampling is critical to verify online sensor responses.
- A data polling frequency of two minutes was found to be optimal for the wide range of sensors tested, but utilities might want to evaluate other polling frequencies.
- A robust Supervisory Control and Data Acquisition (SCADA) system is needed to fully utilize and process in real-time the large volumes of data that are generated.
- The EPA T&E Facility distribution system simulators attempt to replicate field conditions, but the effects of varying water demands were not simulated during the tests. In addition, the background water quality parameter levels are very stable at the T&E Facility. Therefore, for utilities with varying background water quality parameters compounded with varying demands, the simulated tests might result in different sensor/parameter response.
- Instrument manufacturers need to design for allowing an automated grab sample to be collected to validate the instrument response as needed.
- Instrument manufacturers should design their sensors so that they can be easily interfaced with a wide variety of SCADA systems.

obtained by contacting Mr. Steve Allgeier via e-mail (Allgeier.Steve@epa.gov) or phone 513-569-7131. Additional information related to EPA's water security research can be obtained at: <http://www.epa.gov/safe-water/watersecurity/>.

the overall goal of WSi is to design and deploy CWS for drinking water utilities. EPA is implementing the WSi in three phases: (1) development of a conceptual design that achieves timely detection and appropriate response to drinking water contamination incidents; (2) demonstration and evaluation of the conceptual design in full-scale pilots at drinking water utilities; and (3) issuance of guidance and conduct of outreach activities to promote voluntary national adoption of effective and sustainable drinking water CWS. The initial full-scale pilot was implemented in Cincinnati, Ohio. EPA-OGWDW plans to implement more pilot studies utilizing the CWS concept presented in Section 1.3. These pilot studies will be conducted at several utilities to demonstrate that a functional CWS can be deployed under a variety of real-world conditions. Information on the GCWW pilot study can be

3.0 Instrument Setup and Data Acquisition

As previously mentioned in Section 2.5 (and will be discussed later in Chapter 5.0), the tests conducted at the EPA T&E Facility show that free chlorine and TOC are the most useful water quality parameters for detecting changes indicative of contamination in chlorinated water systems. The prototype monitoring panels installed by the WSi pilot utility included online instrumentation to measure free chlorine, TOC, pH, ORP, conductivity, temperature and turbidity. Each utility should evaluate its needs and resources (both capital and labor), and review the test results associated with its water distribution system before selecting a suite of online parameters and associated instrumentation. The use of chloramines as disinfectant should also be taken into account when selecting the parameters and instrumentation. Once the parameters and instruments have been selected, they should be set up in accordance with the instructions provided by the manufacturer for flow, pressure, and sample conditioning requirements. This chapter discusses in detail the various requirements for setting up online water quality sensor instrumentation at a specific site.

3.1 Site-Specific Requirements

EPA-developed software such as TEVA-SPOT should be used to identify the optimal locations of a fixed number of sensors. After a potential monitoring site has been identified using TEVA-SPOT, a site visit should be performed to ensure that the selected site has:

- sufficient environmentally protected secure space for housing the selected instrumentation
- access and a clear path for transporting and servicing the instrumentation to conduct installation and maintenance activities
- adequate source of pressurized and pressure-controlled water supply for the proposed instrumentation
- drainage access to discharge the water analyzed by the online instrumentation
- necessary power supply and backup (uninterrupted power supply) to power the online instrumentation, data collection, and data transmission systems
- appropriate media (wired or wireless) for transmitting the online data in real-time to a specified data collection center
- water quality characteristics that are suitable (or can be appropriately conditioned) for analysis by selected online instrumentation

Depending upon the threat and vulnerability analysis, some of the selected sites might not meet all of the requirements. For such sites, alternate means of meeting a site-specific requirement should be investigated. For example, all sites might be not suited for deploying a single communication technology. In such cases, a combination of wired and wireless communication technology should be investigated. Another example could involve a situation where the initial water quality is not suitable for selected instrumentation. In this case, either alternate instrumentation should be investigated or site/instrument-specific sample water conditioning could be performed such as pH buffering, degassing, or removing iron and salts.

3.1.1 Environmentally Protected Housing

The selected site should be environmentally protected and secure. Many of the online sensors are typically contained in a National Electrical Manufacturers Association (NEMA) class 4- or 4X-compliant corrosion-proof enclosures and protected from wind-blown dust, rain, sleet and external icing. Specifically, a NEMA4-compliant enclosure has to pass the “Hose Test,” which is described as: a 1-inch nozzle, delivering 65 gpm of water, from a distance of 10 feet, from all directions, for a 5-minute time period, with no water leak to the interior. Class 4X enclosures have additional protection against corrosion. Preferred materials for mounting (or housing) the online instrumentation are polyester/glass, stainless steel, and epoxy coatings. Although the selected enclosure might be suited for general outdoor application, there is an additional need for temperature and humidity control because the advanced devices are equipped with onboard computers and electronics that might not withstand the temperature, humidity, and altitude extremes. The environmental tolerances are instrument-specific and the manufacturer instructions should be followed to ensure the suitability of the selected housing. In general, it is not recommended that the instruments be housed in an environment where the temperature exceeds 90°F (32.2°C) or falls below 40°F (4.4°C). Appropriate cooling and/or heating devices should be installed at the site as needed.

Furthermore, the selected instrumentation might have humidity specifications, (for example, a range of 5 to 95%). High humidity might result in corrosion of electronic components and/or could lead to short circuits and malfunction. Humidity can increase the conductivity of the embedded electronics, leading to short circuits and malfunction. Condensation is another problem that can cause electronic devices to malfunction. For example, when an instrument is moved from a colder place

to a warmer and more humid place, condensation could coat circuit boards and other insulators, leading to short circuiting inside the equipment. Such short circuits might cause substantial permanent damage if the equipment is powered on before the condensation has evaporated. Electronic equipment should be acclimatized for several hours (as specified by the manufacturer) before powering on.

3.1.2 Access for Servicing the Instrumentation

The online instrumentation generally requires periodic servicing, calibration and reagent replacement. In a multi-instrument setup, individual instruments are mounted on panels that are fabricated to fit the space requirement and also provide easy access for servicing each instrument. The instruments are set up such that the servicing need for a single instrument does not disrupt the function of other instrumentation. Also, the water intake and drain lines are configured in a manner such that they are generally below the instrumentation so that any water line failure does not damage the instrumentation. In addition, the power conditioning, data logging, and communication equipment are separated from the online instrumentation. Power conditioning devices are designed to regulate the voltage and improve the power quality (e.g., electrical noise suppression and transient impulse protection). Figures 3.1 and 3.2 show instrument panels that have been designed specifically to facilitate online monitoring at the EPA T&E Facility. For example, the sensor shown in Figures 3.1 and 3.2 has all the water lines at the bottom. The sample inlet line to each instrument is isolated. The drain lines are connected to the available floor drain. The data logging equipment is on the back of the panel and the power lines are on top.

The operator should be able to see and service the instrumentation/data collection components with

ease. If the instrument panel is improperly designed, the operator might take shortcuts while servicing, which could lead to lower data quality or equipment malfunctions due to improper servicing.

3.1.3 Pressure-controlled Water Supply

The majority of the water quality instrumentation is sensitive to fluctuations in water supply pressure. Pressure changes can create bubbles (degassing) in the sampled water, resulting in erroneous data. Pressure regulator valves are used to allow water from a high-pressure supply line (or tank) to be reduced to a safer preset level specified by the instrument manufacturer(s). Pressure regulators are also susceptible to changes in the water supply pressure. Sometimes, it might be necessary to have multiple layers of pressure regulation to dampen any effects of pressure fluctuations on the instrument readings. Instruments like particle counters require separate mounted constant-head overflow weir mechanisms so that the sample outlet can be raised or lowered to the height that will produce the desired flow. Figure 3.3 shows the constant head mechanism for a particle counting device.

By pushing water up a fixed-height column and collecting the sample stream from that column, a constant



Figure 3.1 Single Pass DSS Instrument Panel at 80-foot Sampling Location



Figure 3.2 Single Pass DSS Instrument Panel at 1,180-foot Sampling Location



Figure 3.3 Example Constant Head Mechanism for Hach 2200 PCX Particle Counter.

pressure is delivered to the instrument. This method of regulated sample delivery, although simple, is very effective in controlling pressure and flow fluctuations. Hach uses this method of sample delivery for Hach CL-17 free (or total) chlorine analyzers and Hach 2200 PCX Particle Counters. The BioSentry® unit also employs a similar method for delivering constant sample flow.

3.1.4 Drainage Access

The sampled water drawn from the online instrumentation panel needs to be discharged appropriately to meet local discharge requirements. Generally, access to a sanitary sewer line is sufficient. In certain locations, such access might not be easy. Care should be taken so that water does not pool near the instrumentation, causing a slipping hazard. A drain manifold is recommended for locations with multiple online instruments. The drain line should be sized adequately, taking into account any instrument and inlet line failures.

3.1.5 Power Supply and Electrical Protection

Adequate power supply (preferably 3-phase) with a backup device for uninterrupted power supply (UPS) intended to provide sufficient power for the online instrumentation, data collection, and data transmission systems is recommended. In addition, the electrical cir-

cuits to each instrument should be isolated via a circuit breaker, and both the panel and instruments should be appropriately grounded. The electrical isolation allows for servicing of individual instrumentation without disrupting the other equipment installed at the location. Circuit breakers protect the instrumentation from electrical surges and short circuits. Connection to ground is a safety issue designed to protect the personnel servicing the instrumentation and the online instrumentation. The ground connection also helps limit build-up of static electricity on the instrumentation. In areas where the line voltage is known to fluctuate, a surge protector is also recommended. The surge protector regulates the voltage supplied to the instrument by either blocking or by shorting to ground connection when voltages above safe instrumentation thresholds are sensed in the circuit.

A UPS or an inline battery backup lasting four to eight hours is recommended, because it continuously powers and protects the instrumentation from the previously described power problems. A UPS is also known as a power or line conditioner because of this ability. A UPS generally contains a lead-acid battery for storing power. During electrical outages, the energy reserves stored in the UPS are used to power the instrumentation. Figure 3.4 shows a field data communications NEMA 4 enclosure with backup UPS Power.



Figure 3.4 Field Communications Enclosure.

Some instruments provide the option for portable or line power. For example, the YSI 6920DW instrument can be powered by battery or line power. Line power is preferred in installations where the line is backed up with an appropriately sized UPS.

3.1.6 Transmission Media Access

In order to fully realize the benefits of online instrumentation, appropriate media (wired or wireless) should be used in real-time for transmitting the data or information to a pre-specified data collection location. Wired media generally provide higher bandwidth, but could be cost-prohibitive in certain locations. In these cases, the use of wireless media (e.g., licensed or unlicensed radio, cellular, satellite-based transmission media options) should be investigated. In some cases, depending upon the location and media used, the data transmission might be susceptible to various types of interferences. In such cases, additional programmatic error control techniques should be applied to mitigate the errors during transmission. For example, in a poll-based data collection platform, it might be necessary to either increase the number of retries on a failed poll event or adjust the data packet reception window based on the bandwidth and latency limitations of the selected media.

3.1.7 Source Water Quality Adjustment

Generally, the selected instruments need to be suitable to analyze the source water quality. In some cases, the source water quality can be adjusted to meet the instrument specifications. For example, certain free chlorine measuring devices require the pH of the water to be below 8.5 standard units. If the pH at the selected location is above 8.5, appropriate buffering agents (e.g., carbon dioxide) should be used to condition the pH of the sampled water or an alternate online monitoring instrument should be selected for that parameter. For example, the Sievers® RL unit is not appropriate for high pH water (> 8.5).

3.1.8 Instrument-Specific Accessories

As discussed in the previous section, for some instruments, there might be a need for either peripheral support equipment (or accessories) that precondition the sample water or for carrier gases to complete the analysis. The Hach TOC monitor is another example of an instrument that requires specific accessory equipment as identified below.

In general, TOC monitors are one of the more complex instruments to operate. Hach uses the ultraviolet (UV) persulfate method; this method requires reagents (sodium persulfate and phosphoric acid) to drive the oxidation reaction. These reagents are supplied in 5-gallon carboys and are bulky to handle.

This instrument also requires a clean, carbon dioxide (CO₂)-free air source to carry sample flow to the CO₂ detector. The CO₂-free air source is supplied either by a cylinder of liquid nitrogen, or a zero air generator. If a zero air generator is used, an air compressor is needed to supply a constant stream of air. A considerable amount of space is required to house this monitor and its supporting equipment. These units have proven to be fairly labor-intensive to operate and require a highly skilled technician to perform maintenance and calibration procedures. Figure 3.5 shows a Hach astroTOC™ UV process TOC analyzer instrument and associated zero air system.

The Sievers® 900 On-Line TOC Analyzer also uses the UV persulfate method. Similar to the Hach unit, the Sievers® 900 On-Line TOC Analyzer can be fairly labor-intensive to operate and requires a highly skilled technician to perform maintenance and calibration procedures. However, this instrument and its reagent packs are more compact than the Hach unit. Also, the Sievers® 900 On-Line TOC Analyzer does not require an external zero air system/compressor or a liquid nitrogen Dewar. This unit does require an inorganic carbon remover (ICR) for waters that are heavily laden with inorganic carbon. Figure 3.6 shows a Sievers® 900 On-Line TOC Analyzer (the ICR is contained inside the instrument enclosure).

Unless the utility has extensive in-house experience with these instruments, it might be prudent to procure service contracts for each of the aforementioned TOC units. Surrogate TOC monitoring equipment using UV-visible (UV-Vis) spectral absorbance has been found to be less labor intensive, but trade-offs in its limited ability to detect a variety of potential organic contaminants should be taken into consideration.



Figure 3.5 Hach astroTOC™ UV Process Total Organic Carbon Analyzer.



Figure 3.6 Sievers® 900 On-Line Total Organic Carbon Analyzer.

3.2 Calibration Materials/Reagents and Onsite Accessories

During the setup, instrument calibration material, reagents and accessories ought to be available (as needed) to ensure that the instruments are operating as recommended by the manufacturer. Many reagents and calibration solutions have expiration dates; therefore, these reagents should be ordered according to the instrument-specific maintenance schedule. While performing calibration and maintenance activities, each manufacturer's procedure needs to be followed to ensure that the instrument is performing properly and is measuring the water quality in the designated range. Also, proper calibration ensures that the quality of the data is reliable.

3.3 Data Acquisition System

Most water utilities implementing a network of online instrumentation generally have some type of SCADA system. SCADA systems are also known as industrial control systems and are capable of monitoring and controlling a process. Generally, water treatment plants are automated with some type of SCADA system. From a water utility perspective, a SCADA system generally

consists of the following four components:

1. a Human-Machine Interface (HMI), which is a combination of computer software and hardware that presents information to an operator; the operator is able to monitor and control the process/instrumentation through this interface.
2. a supervisory or a central node that gathers data from a programmable logic controller (PLC) and/or a Remote Terminal Unit (RTU) for presentation to the operator through the HMI and sends commands to the PLC/RTU based on the operator inputs from the HMI.
3. PLCs/RTUs connected to the online instrumentation that convert sensor signals to digital data (inputs) and send commands to connected automated devices (such as sampling devices and pumps) to perform a pre-defined task based on operator commands from the HMI.
4. a data communication infrastructure connecting the supervisory system to the PLC/RTU.

Figure 3.7 shows a data flow schematic from field-deployed online instrumentation to the operator in a control center.

Historically, SCADA system hardware and software tend to be proprietary. Water utilities that have invested in a particular manufacturer's solution might find themselves restricted to limited choices for equipment when considering system expansions or upgrades. However, most SCADA systems can communicate with sensors or instrumentation that can provide their data output in 4 to 20 milliamperes (mA), or through serial protocols such as Recommended Standard 232 (RS-232)/Recommended Standard 485 (RS-485). The RS-232/RS-485 electrical specifications are defined by the Electronic Industries Alliance (EIA) for a serial communications channel.

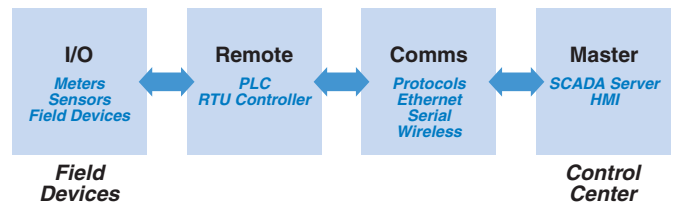

Figure 3.7 SCADA Data Flow Schematic

3.3.1 4 to 20 Milliamperes Current Output

Developed in the 1950s, the 4 to 20 mA instrument outputs are still widely used by SCADA and instrument manufacturers. This output format is ideally suited for low-cost instruments that provide one or two analog

output values. Generally, the output signal can travel distances of around 50 meters. In other words, the PLC/RTU capturing this data output from the instrument must be located within 50 meters of this instrument. This output is easy to understand and troubleshoot: a signal of 4 mA represents zero percent of the output span and 20 mA represents one hundred percent signal output span. For example, a chlorine monitor calibrated to measure a span between 0 and 5 parts per million (ppm) will provide a corresponding analog output between 4 and 20 mA when reporting these values. Troubleshooting the output is simple, requiring only a digital voltmeter to read the values inline.

3.3.2 Serial Protocols

Developed in the 1960s, the RS-232 is a serial protocol for sending and receiving signals between a Data Terminal Equipment (DTE) and Data Circuit-terminating Equipment (DCE). Prior to the popularization of the Universal Serial Bus (USB), the RS-232 serial port was commonly available with all types of personal computers. The RS-232 connection (at a minimum) needs 3 wires to communicate where one wire is dedicated to transmitting data, one to receiving data, and one is ground. The RS-232 can even use a two-wire connection (data and ground) if the data flow occurs one way. The RS-232 standard defines the voltage levels that correspond to logical one and logical zero levels. Valid signals are plus or minus 3 to 15 volts.

RS-485 (also known as EIA-485) is a multipoint serial communications channel that can span distances of up to 4,000 feet. The multipoint communication is often in a master-slave arrangement when one device dubbed “the master” initiates all communication activity with other devices in the network. RS-485 is used as the underlying protocol in many standard and proprietary SCADA protocols, including the most common versions of Modbus.

3.3.3 Data Communication Protocols

Typical legacy SCADA communications protocols include Modbus (developed by Modicon), RTU Protocol (RP-570) and PROFIBUS. These communication protocols are all proprietary and SCADA-manufacturer specific, but are widely adopted and used. During the late 1990s, many of the SCADA manufacturers shifted toward more open communication protocols and adopted the “*de facto*” open message structure offered by Modbus over serial communications protocols such as RS-232/RS-485. Since 2000, most SCADA manufacturers are offering greater open interfacing operability by adopting standards such as Modbus Transmission Control Protocol (TCP) over Ethernet and Internet Protocol (IP). Other standard communications protocols include: International Electrotechnical Commission

(IEC) 60870-5-101 or 104, IEC 61850 and Distributed Network Protocol 3. These protocols are standardized and recognized by all of the major SCADA manufacturers. Similar to Modbus, many of these protocols now contain extensions to operate over TCP/IP.

3.3.4 SCADA Setup and Poll Rate

Generally speaking, most water utilities embarking on online monitoring have some type of SCADA system in place. It is generally cost-effective to expand on existing SCADA systems to accommodate online water quality monitoring and integrate it with distribution system and treatment plant operations as needed. For a large utility (serving >100,000 persons), it is common to have tens of thousands of SCADA tags [or SCADA input and output (I/O) values] that are polled by the SCADA “master device” periodically. Depending upon the poll cycle and available data bandwidth, polling most of these SCADA I/O values every one to five minutes is common. The online water quality instruments themselves have a sampling cycle, and a vast majority of these have sampling and reporting cycles of less than one minute. However, in some cases, the sample cycles for achieving peak measured values might be between four and eight minutes (e.g., Hach astroTOC™ UV process TOC analyzer and Sievers® 900 On-Line TOC Analyzer). The data acquisition system used at the EPA T&E Facility was set to poll every two minutes. Based on a review of the data generated during this testing, the researchers at the T&E Facility conclude that a device poll rate of every two minutes is sufficient to produce data quality that can reliably be processed by algorithms to evaluate significant changes in water quality that is protective of human health for most locations. However, the utilities might want to evaluate other polling frequencies.

3.3.5 Data Marking

The SCADA system should be set up so that calibration events, bad data, and instrument warnings (low reagent) are captured and “marked” within the SCADA water quality database. This will permit the algorithms analyzing the data in real-time to exclude these marked data from further analysis, as any anomalies resulting from these data are unlikely to be actionable.

3.3.6 Data Transmission and Storage

Data transmission at the T&E Facility and nearby associated locations use a variety of communication media, including wired and wireless (radio and cellular) technologies.

For large SCADA implementations, the majority of the newer SCADA software manufacturers recommend the use of a centralized (or distributed) database as the back-end data repository. Generally, older data that are not needed for any real-time analysis or computations

are archived/stored in a database traditionally referred to as the “historian.” The real-time and the near real-time values are usually run through an event-driven calculation engine that either automatically performs a task when predefined conditions are met or raises an alarm for the operator to intervene or acknowledge the SCADA value exception. Typically, the commercial SCADA systems only allow the operator to define set points (both at high and low levels) for each monitored parameter to trigger an alarm.

The database storage and retrieval mechanism allows for add on algorithm-type programs, which can evaluate the water quality data in real-time, compare it to the baseline data in the database, and raise alerts and alarms based on computed values and data trends.

The T&E Facility water quality data is stored at multiple locations. The iSIC datalogger and the iChart application store the data in proprietary formats. The iChart stores the data in encrypted eXtensible Markup Language (XML) and also pushes the data to a separate Open Database Connectivity (ODBC)-compliant MySQL database for storage and retrieval over the network using commonly available tools. Figure 3.8 shows the T&E Facility NexSens iSIC datalogger.



Figure 3.8 T&E Facility NexSens iSIC Datalogger

3.4 Best Practices for Instrument Setup and Data Acquisition

Each utility, equipment developer/manufacturer should review the site-specific requirements identified in Section 3.1 of this document. For the utilities, if technically feasible, a single standard type of panel mount for housing all of the instrumentation/ SCADA is recommended. In cases where a one-size-fits-all solution is not possible (due to space constraints), no more than two or three types of standard panel designs are recommended for field implementation. Each of the addi-

tional panel types could be designed to eliminate site-specific length, width or depth constraint(s). The panel standardization makes the fabrication and maintenance easier. Within each type of panel, the following design factors are of prime importance:

- Each instrument should be both electrically and hydraulically isolated (i.e., each instrument has its own circuit breaker, separate water inlet with a ball valve).
- Flow monitoring devices should be non-fouling (i.e., a rotameter without flow control or float guide-wire, which tends to accumulate biological growth and particle debris) and instrument-specific in the correct flow range.
- To conserve water, some of the instruments can be designed to accept the discharge of another non-reagent based instrument.
- In cases where the inlet water tends to be colder than the environmental housing, degassing (bubbles) can negatively impact the performance of some instruments. The discharge side can be pressurized for some instruments to minimize the degassing effect. In other cases, a bubble trap or a constant head mechanism could prove effective.
- The panels should be accessible and well-lit (with an external light source)
- The sites should have sufficient space to be ergonomically efficient. This will prevent the operator from taking shortcuts while performing maintenance activities.
- There should be a workbench, restrooms, a place to store supplies and chemicals onsite to maximize operator efficiency.

Equipment manufacturers should try to minimize the footprint of their device and ensure that the housing is NEMA-compliant. Wherever possible, the fluid lines should include moisture sensors and be below the electrical and data acquisition components to minimize damage in case of a leak. In case of malfunctions, the instruments should be robust and have an alarm function and self-restarting capability.

Data acquisition using field RTUs should be standardized by the water utility so that the programming can be simplified and replicated across sites. If data transmission at a particular location is prone to interferences, programmatic error control techniques should be applied to mitigate the errors. The data acquisition and communication units should be UPS-backed and equipped with lightning/surge protection. The

manufacturers should ensure that the sensor is able to communicate with the field RTUs, using the common SCADA communication protocols.

Wireless data transmission should use secure protocols where possible. Other SCADA related cyber-security recommendations should be implemented whenever possible. The data should be stored in databases with ODBC connectivity and routinely backed up. The ODBC connectivity enables the use of third party data analysis tools/applications or event detection algorithms such as CANARY to interface with the data in real-time. In addition, data should be marked for instrument alarms, errors, and calibration events so that they can be filtered out by the algorithms while analyzing the data for anomalies.



Water Utilities and Sensor Manufacturers

- Trade-offs should be considered when locating online sensors at the optimal TEVA-SPOT identified location or at an alternate nearby utility-owned location that meets site-specific requirements identified in Section 3.1.
- Pressure fluctuations, flow control, bubble formation, and higher pH values might impact data quality of many online sensors. Manufacturers should provide robust non-fouling flow controls with the sensor and eliminate the potential for bubble formation in their equipment. Both utilities and manufacturers should consider the addition of pressure regulators and constant head devices prior to sensor elements.
- Manufacturers should add alarm output channels to identify instrument-related problems such as low reagents, instrument calibration drifts, etc. Also, manufacturers should provide a variety of interface options for SCADA communications protocols. In addition, the instruments should be designed to have a small footprint with built-in self-restarting capability in case of malfunctions.
- Utilities considering setting up a panel of instruments should review the important panel design factors identified in Section 3.4. Utilities should also standardize the data acquisition approach and follow the best practices identified in Section 3.4.
- Online TOC monitoring equipment employing UV-persulfate methods are expensive and difficult to maintain. Factory service contracts are recommended. One of the TOC instruments, as tested at the T&E Facility, requires a carbon-free air source (i.e., a compressor/generator or nitrogen tanks). Manufacturers should design and fabricate simplified TOC monitoring devices.

4.0 Testing Procedures and Safety Precautions

Prior to evaluating various online sensors at the T&E Facility, a Quality Assurance Project Plan (QAPP) and a Health and Safety Plan (HASP) were developed. The QAPP outlined the experimental and analytical objectives. The HASP outlined the safety precautions necessary for handling the selected contaminants. Some of the critical elements obtained from the QAPP and HASP that are applicable to the testing program (which might benefit water utilities and manufacturers of sensors considering such internal testing) are described in the following sections.

4.1 Blank/Control Injection

Prior to injecting any contaminant into the DSS (Single Pass or Loop No. 6), a control run was made to ensure that there were no significant contributions to the baseline water quality sensor response from the pumping action of the injection apparatus, the DSS itself, or any associated instrumentation. The blank/control injection matrix was designed to match the water matrix for each specific contaminant and was either Cincinnati tap water or granular activated carbon-filtered Cincinnati tap water. This procedure ensures that significant changes are not caused by either the absence of the selected disinfectant (chlorine, chloramines) or naturally occurring material in the injected water. Figure 4.1 shows the injection apparatus used for testing on the Single Pass DSS.

4.2 Contaminant Injection Procedures

As discussed previously in Section 2.2, various contaminants, surrogates, carrier/growth media were selected to represent a range of chemical, biological and radiological agents that might be accidentally or intentionally introduced into a water distribution system. This section provides details on the injection specifics.

4.2.1 Concentration of the Injected Contaminant

Several factors were considered while establishing the injected concentration/dosage of the selected contaminants. These included the following: solubility of the selected contaminant in water, results from the bench-scale minimum dose sensor response study, and target concentrations lower than the Immediately Dangerous to Life or Health (IDLH) level for the selected contaminant. Mixing times and solubility observations were made from beaker tests before performing the injection event. The bench-scale minimum dose sensor response study was performed to determine the “detection limit”

associated with a particular water quality monitoring sensor for the selected contaminant. The purpose of the bench-scale and the DSS Loop No. 6 and Single Pass DSS studies was to determine if it was possible to inject a contaminant at a concentration that was high enough to cause health effects, but could not be detected by the array of sensors. Contaminant concentrations of 1 mg/L were typical for both the DSS Loop No. 6 and the Single Pass DSS injections. This concentration was usually detectable by at least one water quality sensor; yet, for a vast majority of the contaminants, it represented a concentration well below the IDLH level. In comparison, other EPA-sponsored Environmental Technology Verification (ETV) studies have been conducted using contaminant injection concentrations of 10 mg/L, which are generally well within the detection range of most instruments and suitable for tracking the precision and accuracy of the test instruments.

4.2.2 Duration of Injection

For the purposes of determining the minimum duration necessary to detect a water quality baseline change, 2-minute injections were performed. These short-duration injections were successfully detected by the sensors, even though some of the instrument sampling durations exceed the 2-minute injection period. To evaluate total dosage necessary to cause potential harm to humans, a longer 20-minute injection duration was selected. This duration also allowed for stable tests with a maximum response time long enough to see a change in baseline that could be detected by automated algorithms. After injection, data from the various sensors were monitored and recorded for at least 4 hours for the DSS Loop No. 6 tests, and for at least 1 hour for the Single Pass DSS tests. The algorithms and data analysis techniques are discussed in Chapter 5.

4.2.3 Water Main Flow Rate and Injection Rate

The flow rate through DSS Loop No. 6 was typically kept at 88 gpm, which also translates to a velocity of



Figure 4.1 Injection Apparatus for the Single Pass DSS

1 foot per second (ft/sec) through the 6-inch pipe. This velocity is commonly encountered in a distribution system. Similarly, most of the testing that was conducted on the Single Pass DSS was performed at a flow rate of 22 gpm, which also yielded a velocity of approximately 1 ft/sec in the 3-inch pipe. All of the testing was conducted under turbulent flow conditions. In some of the tests, the flow rate of the Single Pass DSS was varied to obtain the desired contaminant dilution effect based on available stock concentrations. The following flow rates were used for testing in the Single Pass DSS: 5, 10.7, 22, and 40 gpm. The typical injection rate was 0.5 liter per minute (0.13 gpm). Whenever technically possible (based on solubility and any other constraints discussed in Section 4.2.1), a batch of 10 liters of contaminant in water was injected over a 20-minute period.

4.2.4 Neat Compounds Versus Commercial Off-the-Shelf Products

For the purposes of evaluating how effective the online sensor instrumentation is in detecting herbicides and pesticides, manufacturers of some of the commercially available off-the-shelf products were contacted to obtain the neat (or pure) form of the active ingredient in the product. During the bench-scale studies, it was discovered that the inactive ingredient in commercial off-the-shelf herbicides/pesticides might change water quality in a detectable manner. For the DSS Loop No. 6 testing, Real Kill® (pesticide) and Roundup® (herbicide) were used to represent large groups of similar commercially available compounds that are readily available and accessible.

4.2.5 Wastewater and Ground Water Injections

Wastewater and ground water injections were conducted to simulate natural or accidental contamination events such as cross-connections and broken mains. There have been cross-connection and back flow events reported where contaminated wastewater has entered the distribution system. Also, it is possible for mains under the water table to seep or infiltrate ground water.

4.3 Testing and Analytical Confirmation

In addition to the blank and control injections described in the previous section, the DSS tests were repeated both for DSS Loop No. 6 (in triplicate) and Single Pass DSS (in duplicate) to ensure that the sensor responses were valid and repeatable. The EPA ETV studies conducted at the T&E Facility also evaluated inter-unit reproducibility by deploying multiple units concurrently for testing purposes. In addition, NHSRC's TTEP is designed to provide reliable information regarding the

performance of homeland security related technologies. More information on the TTEP program can be obtained from the EPA website: <http://www.epa.gov/nhsrc/ttep.html>.

4.3.1 Testing Confirmation

The initial rounds of triplicate testing in DSS Loop No. 6 yielded consistent results based on the direction of parameter-specific change. For the later rounds of testing, only duplicate runs were performed. In case a test run yielded inconsistent results due to equipment malfunction, an additional test run was performed as needed. Figure 4.2 shows a sample graph of triplicate test results for glyphosate conducted on DSS Loop No. 6. Figure 4.3 shows a sample instrument response with increasing injected contaminant (glyphosate) concentrations, conducted in the Single Pass DSS.

4.3.2 Analytical Confirmation

Bench-top analytical tests were performed to confirm the water quality parameter readings of the online instrumentation. As shown in Figure 4.2, the grab samples matched the results of the online instrumentation, with the exception of ORP. The ORP readings are altered when the sample is exposed to atmosphere during the grab sampling event. In addition, for some of the contaminants (malathion and glyphosate), to ensure that the injected contaminant was not absorbed/adsorbed into the biofilm or pipe material, grab sampling from the sample taps of online sensor instrumentation was performed. These grab samples were submitted to an outside laboratory to perform analytical confirmation. Although the analytical results confirmed the presence of these contaminants, the concentration levels were found to vary. The varied results were attributed to the following: 1) relatively poor analytical methods, which were chosen by the outside laboratory; 2) injected compounds interacted with free chlorine in the test water, which might have resulted in the generation of other by-products that were not measured; and 3) possible adsorption/absorption to the biofilm. However, as the changes in the measured water quality parameters were consistent with the injected level of contaminants (as shown in Figure 4.3), the analytical confirmation was abandoned to keep up with the rapid pace of testing and to reduce project costs.

4.4 Flushing and Baseline Establishment

Between the test runs, DSS Loop No. 6 was continuously operated to flush the system. In addition, prior to the test runs, DSS Loop No. 6 was sufficiently flushed so that the water quality parameters (especially turbidity and temperature) equilibrated and remained stable during the test. This parameter stability was confirmed by

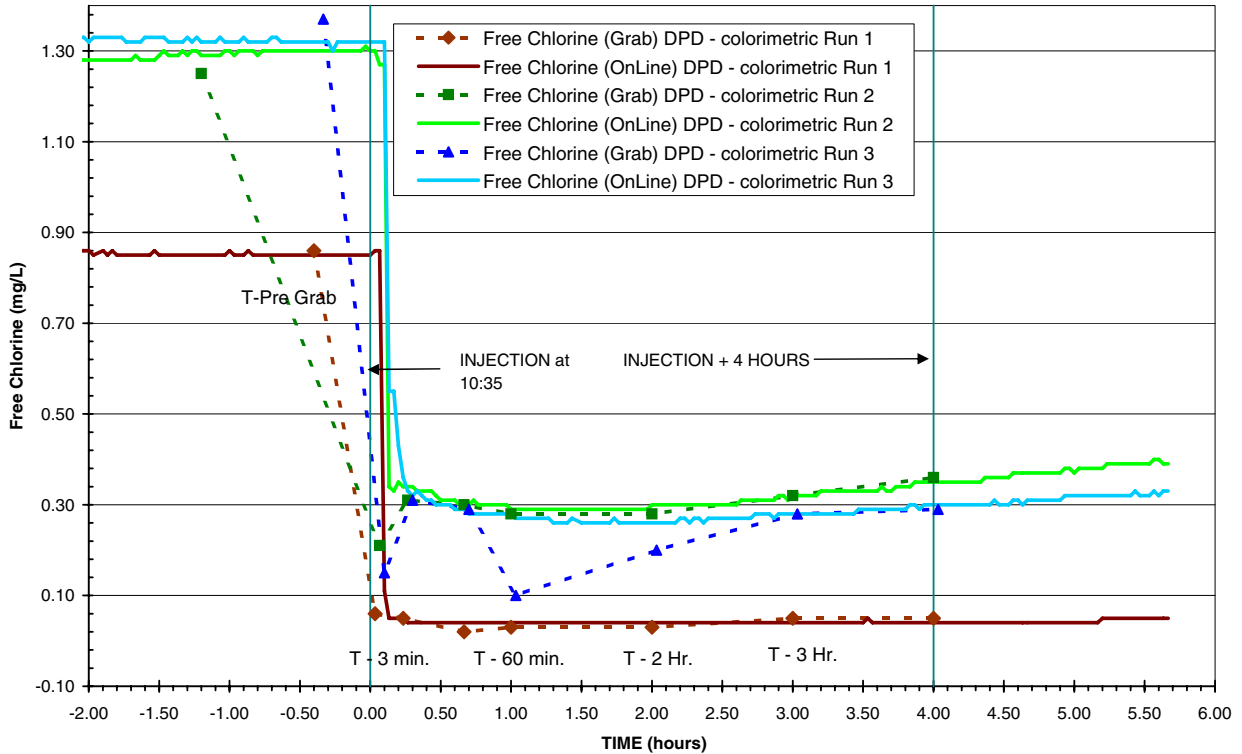

Figure 4.2 Glyphosate Triplicate Injection Run Results

evaluating the online instrument baseline data to ensure that the instrument readings were within the “normal” range of operation. If the instrument readings deviated from normal conditions (based on operator experience), the instrument was recalibrated to ensure accuracy and repeatability.

4.5 Health and Safety Precautions

Standard laboratory personal protective equipment such as laboratory coats, gloves, safety glasses, and safety shoes were required during the experiments. For chemical contaminants, additional test/contaminant-specific protective gear might be required in accordance with the Material Safety Data Sheet or contaminant-specific HASP.

For biological contaminants, depending upon the contaminant, the biohazards and the risk of infection should be minimized. All of the biological contaminants used for the testing at the T&E Facility were non-pathogenic. The surrogates closely represent the biological activity of real

pathogens (Edberg et al., 2000; Lytle and Rice, 2002; Rice et al., 2005; Sivaganesan et al., 2006). However, as part of good laboratory practice, standard Biosafety Level 1 measures were implemented. Personnel had to change gloves after coming in contact with items that might carry biological contaminants. Gloves could not be placed near the face after exposure to biological contaminants. Any positive reference materials were handled with gloves in an appropriate laboratory hood.

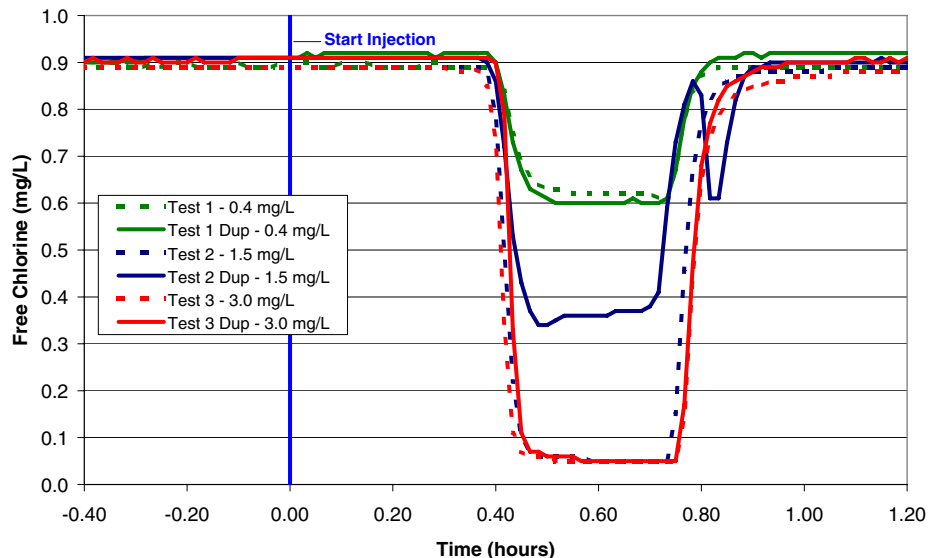

Figure 4.3 Glyphosate Injections at Varying Concentrations

Equipment and supplies that came into contact with suspected biohazard materials had to be sterilized prior to disposal or reuse. The contaminated equipment/supplies were sterilized by either standard autoclaving or wiping with 0.02% bleach solution, depending on the extent of contamination and the type of material constituting the equipment/supplies. Waste samples had to be autoclaved prior to disposal. Special precautions, such as donning heat-resistant gloves, were required for autoclaving.

4.6 Disposal of Contaminated Water From Test Runs

The EPA T&E Facility operates under a discharge permit from the Metropolitan Sewer District (MSD). This permit authorizes the direct discharge of specified levels of contaminants to the local, publicly owned wastewater treatment facility. The aforementioned sensor technology testing at the T&E Facility was conducted so that all of the test water could be directly discharged to the sewer system. Utilities and sensor manufacturers considering such testing at their facilities should evaluate their contaminant-specific discharge limits prior to initiating a testing program. If the discharge limits for the selected contaminants are too low, it might be necessary to make alternate arrangements for disposal of the test water (e.g., local treatment before discharge, offsite shipment) or modification of the permit.

4.7 Best Practices for Testing and Safety Precautions

In order to avoid positive bias from any of the injection equipment/sampling or monitoring equipment, all testing components should be disinfected and calibrated so that an accurate baseline is established prior to testing.

Test contaminants (or surrogates) should be selected so that they represent a broad class of potential threat agents. The target concentrations should be at or below the levels where human health can be adversely affected, including considerations for sensitive/susceptible subpopulations. The selected duration of injection should be optimized to minimize the use of contaminants for both cost control and waste discharge considerations. Whenever possible, for instruments measuring physical and chemical parameters, bench-scale testing is recommended prior to pilot-scale or full-scale testing to determine the levels at which the selected instruments can detect the selected contaminants.

A QAPP can help establish a detailed experimental plan that identifies specific types and quantities of the contaminant(s) involved during the testing. The QAPP can also help to define the overall experimental objec-



Water Utilities and Sensor Manufacturers

- Control and blank injections should be performed to ensure that the water quality sensors are not impacted by the injection apparatus.
- The testing at the T&E Facility revealed that the commercially available online water quality sensor equipment can generate reproducible data responses with duplicate contaminant injections and also at varying concentration levels.
- Stable or predictable baseline water quality levels are needed to obtain useful data from the online water quality sensors. The variation in background values should be considered when locating online sensors. Also, baseline data should be collected for a sufficient time period to capture normal water quality variability for each location.
- Without varying water demands, contaminants were found to travel as a slug or in plug flow within the Single Pass system. Recirculating DSS Loop No. 6 experienced fully mixed conditions within several minutes.
- Utilities and manufacturers considering inhouse testing should select contaminants that represent a broad class of potential threat agents, develop a detailed experimental plan/QAPP/HASP, and evaluate potential disposal options prior to conducting any test runs.

tives, standardize the experimental procedures, establish protocols for instrument calibration (prior to testing), and establish data quality that can be technically defensible when reviewed.

Prior to any testing, a HASP should be developed, reviewed, and approved by appropriately trained personnel so that the tests can be performed safely. The HASP will identify minimum job hazards and controls, sample handling techniques, personal protective equipment, work practices and engineering controls, and spill/emergency procedures. This documentation also helps in determining if the test water can be directly and safely discharged (without treatment) based on the facility's existing discharge permit. Otherwise, it will be necessary to make arrangements for appropriate waste-handling procedures. In addition (if needed), HASPs can identify appropriate safety training programs, personal monitoring needs, and medical surveillance based on the contaminant and concentration used.

5.0 Data Analysis

Water quality sensor response data generated at the T&E Facility enabled EPA to construct a qualitative sensor parameter response matrix for the contaminants tested. Analysis of this data required that the concept of a significant change from baseline water quality conditions be defined. A significant change is a large enough deviation from normal water quality parameters that could be used to trigger an alarm to be transmitted to the data user (i.e., a drinking water utility). The criteria for determining a significant change in the sensor parameter was subjective at the early stages of the investigations. Initially, significant change determination was based on visual qualitative inspection (e.g., drop in free chlorine and increase in measured TOC value) of the plotted sensor responses over the course of the contaminant injection test runs. Later on, the significant change determination was based on a quantitative approach: the maximum change observed within a short time period of contact (defined as 15 minutes) of the sensor with the contaminant was divided by the baseline value of the parameter to compute a percent change or deviation (Hall et al., 2007). Although this method was simple and straightforward, it omitted several critical factors such as slow sensor response times and noisy background data. Therefore, the same response data was also evaluated using basic statistical methods that are described in Section 5.1 of this report. As demonstrated later in this chapter, the significant change threshold is dependent upon the variability of the baseline water quality data at a particular monitoring site. Based on the testing conducted at the T&E Facility, EPA developed and utilized the significant change thresholds presented in Table 5.1 for evaluating contaminant injection sensor response data. These threshold values are not entirely based on measured or statistically derived values;

Table 5.1 Parameter-Specific Significant Change Thresholds

Water Quality Parameter	Deviation from Baseline Classified as "Significant Change"
Temperature	± 0.15°C (~0.27°F)
Specific Conductance	> 5% increase
Dissolved Oxygen	± 0.2 milligrams per liter
Oxygen Reduction Potential	± 20 millivolts
Nitrate	± 10%
Chloride	± 15%
Ammonia	± 20%
Turbidity	> 200% increase
Free Chlorine	> 5% decrease
Total Organic Carbon	> 0.1 mg/l increase

the operator's understanding of the variability of water quality at each location should also be taken into account while developing these parameter-specific significant change thresholds. For example, the baseline water quality parameters observed at the T&E Facility are stable with little variance. Therefore, using these values at a location where the water quality baseline is highly variable can lead to triggering of an excessive number of false positive alarms. Keeping these observations in mind, it is recommended that the end-users employing this methodology should develop their own site-specific significant change thresholds for evaluating real-time water quality data.

During the course of this research, EPA was aware that the significant change data analysis approach, which used visual inspection of time series data and percent change from baseline, could lead to variable results caused by site-specific water quality differences and analyst bias. Therefore, a more sophisticated quantitative approach was undertaken: individual sensor responses were analyzed by computing absolute change, percent change, and S/N ratio. Absolute change and percent change analysis employ the same mathematical techniques described previously in the development of significant change thresholds. The S/N ratio analysis is designed to filter the level of "background noise" caused by frequent fluctuations in the baseline data. The S/N ratio is defined as the ratio of a measured value to the background noise. A low S/N ratio indicates that the change in measured value of the parameter might be caused by the background noise (representing routine fluctuations in measured baseline) rather than resulting from a real change in water quality due to the presence of contaminants (Szabo et al., 2006, 2008a, and 2008b). Furthermore, EPA's field installation experience has indicated that the baseline water quality at certain locations (that are immediately influenced by utility operations) can change significantly over a short time period. For example, monitored parameters might fluctuate dramatically with changes in the operation of tanks, pumps, and valves. The monitored parameters are also affected by daily and seasonal changes in the source and finished water quality, as well as fluctuations in demand. EPA collaborated with SNL to build an automated algorithmic data analysis tool that combines and enhances some of the previously mentioned qualitative and quantitative approaches to distinguish between normal variations in water quality and changes in water quality triggered by the presence of contaminants (McKenna, et al., 2006). These types of tools are often referred to as event detection algorithms, which can read SCADA data (water quality signals, operations data, etc.), perform analysis in near real-time, and return a 0/1 result (indicating presence or absence of an alarm). All of these approaches are discussed further in this chapter.

5.1 Non-Algorithmic Sensor Response Evaluation

The qualitative and quantitative approaches employed to evaluate the data generated at the T&E Facility and Edgewood Chemical and Biological Center (ECBC) are discussed in the following subsections.

5.1.1 Single Pass DSS Data Analysis

The data tabulated and reported in this section was generated by injecting selected contaminants (as listed in Tables 5.2 through 5.7) into the Single Pass DSS using chlorinated tap water available at the T&E Facility (as supplied by GCWW). As mentioned previously, the background values are generally stable at this location. The range of background values for the routinely measured water quality parameters are as follows: free chlorine – 0.8 to 1.1 mg/L, specific conductance – 300 to 600 μ S/cm, ORP – 500 to 700 mV, pH – 8.5 to 8.8 standard units, turbidity < 0.1 NTU, and TOC – 0.3 to 1.3 mg/L. Table 5.2 shows the percent change of several water quality parameters for various injected contaminants in the Single

Pass DSS (described in Section 2.1.2). The qualitative response information in Table 5.2 is color-coded to show changes that exceed 10% from the baseline value. Percent change is calculated by first calculating the difference between the baseline mean over one hour before injection, termed absolute change (AC):

$$AC = S_{\text{peak}} - S_{\text{baseline}}$$

Where, S_{peak} = the peak sensor value between when the contaminant is in contact with the sensor until 15 minutes after and S_{baseline} = the mean baseline value for one hour immediately preceding the contaminant injection test.

Percent change is then calculated as follows:

$$\% \text{ Change} = \frac{AC}{S_{\text{baseline}}}$$

Table 5.2 allows for easy identification of online water quality monitoring parameters that would potentially respond to the specified injected contaminants. An examination of Table 5.2 reveals that free/total chlorine and turbidity provide a significant change

Table 5.2 Percent Change in Sensor Parameter Response to Injected Chemical Contaminants in Chlorinated Water – Single Pass DSS

Chemical Contaminants	Initial In-Pipe Concentration (mg/L)	Free Chlorine	Total Chlorine	Chloride (Cl)	Specific Conductance	Dissolved Oxygen (DO)	Oxidation Reduction Potential (ORP)	pH	Turbidity
Aldicarb	0.2	-9.0%	-8.8%	2.3%	0.2%	0.0%	-0.3%	0.3%	188.5%
	1.1	-43.6%	-43.5%	-2.8%	0.0%	-1.2%	-0.6%	0.0%	487.0%
	2.2	-87.6%	-82.9%	2.7%	0.0%	0.1%	-1.2%	-0.1%	-100.0%
Glyphosate	0.4	-34.4%	-17.1%	3.0%	-0.0%	1.2%	-0.1%	-0.1%	1003.5%
	1.5	-77.9%	-39.3%	2.0%	0.0%	1.3%	-0.9%	-1.4%	329.2%
	3.0	-95.2%	-52.4%	2.6%	-0.0%	0.6%	-2.6%	-4.6%	-100.0%
Colchicine	0.4	-2.7%	0.3%	1.6%	0.1%	3.2%	0.2%	0.3%	593.3%
	1.8	-4.3%	-3.9%	0.1%	0.4%	1.3%	-0.4%	0.2%	157.0%
	3.6	-5.6%	-4.2%	-0.6%	0.0%	-5.0%	-0.7%	0.2%	111.1%
Dicamba	0.8	-2.8%	0.0%	-1.4%	-0.0%	-0.6%	0.6%	-0.3%	0.0%
	1.3	-3.1%	-1.7%	-1.3%	-0.3%	-0.5%	0.6%	-0.5%	-6.9%
	2.6	-1.9%	0.5%	-0.6%	0.2%	-0.6%	0.5%	-0.7%	-7.1%
Dimethyl Sulfoxide	0.6	-11.8%	-9.5%	-1.5%	0.1%	-0.4%	0.2%	0.2%	4.4%
	2.0	-29.2%	-26.0%	-0.1%	0.1%	-0.9%	-0.3%	0.3%	1.0%
	4.0	-46.9%	-42.6%	0.1%	0.1%	-1.3%	-0.3%	0.1%	2.0%
Lead Nitrate	0.6	-3.9%	1.3%	-5.4%	0.0%	2.3%	0.2%	-0.2%	400.0%
	0.7	-2.9%	-2.0%	-0.8%	-0.1%	-3.4%	-0.1%	-0.1%	137.2%
	1.4	-0.3%	-2.0%	-0.7%	-0.1%	-0.9%	-0.9%	-0.1%	538.4%
Mercuric Chloride	0.4	-2.5%	-1.2%	-1.6%	0.0%	0.0%	0.2%	-0.1%	26.3%
	1.1	-1.0%	-1.5%	-1.7%	0.3%	-7.3%	0.5%	-0.7%	46.9%
	2.2	-1.1%	0.1%	-2.3%	0.4%	-8.0%	0.8%	-1.2%	-1.4%
Nicotine	0.4	-14.3%	-7.9%	2.4%	0.2%	1.4%	0.2%	0.3%	1200.0%
	1.9	-49.3%	-28.6%	0.5%	0.0%	1.5%	-2.4%	0.7%	82.0%
	3.8	-84.7%	-47.8%	2.4%	0.1%	-1.5%	-4.8%	1.0%	143.4%
Potassium Ferricyanide	0.6	-3.7%	0.8%	11.9%	-0.1%	-0.4%	0.5%	0.1%	287.7%
	1.6	-5.7%	8.0%	14.5%	0.5%	-0.6%	-0.3%	-0.2%	503.2%
	3.2	-4.1%	21.2%	26.3%	0.8%	-0.1%	-0.1%	-0.1%	50.0%
Sodium Thiosulfate (Anhydrous)	0.2	-15.1%	-13.3%	2.8%	0.4%	-0.1%	0.1%	0.3%	883.3%
	1.3	-75.5%	-72.1%	2.2%	0.6%	-1.2%	-1.1%	-0.1%	385.4%
	2.6	-98.8%	-95.1%	4.9%	0.8%	-2.6%	-5.3%	0.1%	645.2%
Sucrose	0.6	-2.9%	-0.7%	-1.0%	0.1%	1.4%	3.7%	0.0%	167.8%
	1.8	-3.2%	-0.4%	-0.9%	0.0%	-5.7%	1.1%	-0.1%	449.1%
	3.6	-2.6%	-0.1%	-0.7%	0.0%	-3.8%	0.4%	-0.1%	433.3%
Control Blank	0	2.4%	1.6%	5.5%	0.5%	0.5%	1.8%	0.2%	52.5%
	0	1.0%	0.2%	0.6%	1.1%	1.0%	2.0%	0.1%	71.8%
	AVG ^a	1.7%	0.9%	3.1%	0.8%	0.8%	1.9%	0.2%	62.1%

■ indicates that the percent change was >10% of the baseline within 15 minutes.

^a Average of two control blank runs. Data presented in this table was not corrected to accommodate for the control blank response.

signal for a majority of the contaminants tested.

Table 5.3 shows further manipulation of the same dataset (presented previously in Table 5.2). The data presented in Table 5.3 has been normalized and adjusted to correct for the S/N ratio for each monitored parameter. The S/N ratio was calculated as follows:

$$S/N = \frac{AC}{\sigma_{\text{baseline}}}$$

where σ_{baseline} = the standard deviation in the baseline for one hour prior to injection.

In Table 5.3, further manipulation of the original dataset (see Table 5.2), reveals that the turbidity parameter is no longer a good indicator of significant change, as shown in Table 5.2, because the baseline signal is too noisy. The data in Table 5.3 also reveal that there are other water quality parameters that might be good at detecting contamination, but do not appear so at first glance in Table 5.2. For example, pH and ORP changed in response to four and seven of the eleven injected con-

taminants, respectively. Both parameters have stable baselines (low standard deviation) and produced small changes when contaminants were injected. However, because the baselines were so stable, the normalized and S/N-adjusted change was relatively large. Tables 5.2 and 5.3 provide examples of how non-algorithmic analyses of water quality data can be useful. The tables also identify some pitfalls to be avoided when interpreting online data. Additional data on the response of water quality sensors to biological suspensions and culture broth are presented in Tables 5.4 through 5.7.

5.1.2 Recirculating DSS Loop No. 6 Data Analysis

The data tabulated and reported in this section were generated by injecting selected contaminants (as listed in the individual tables) into recirculating DSS Loop No. 6 (described in Section 2.1.1) with chloraminated water prepared at the T&E Facility. The preparation methodology for the chloraminated water was described previously in Section 2.2.1. For performing these tests, the background chloramine level

Table 5.3 Normalized, Signal-to-Noise Corrected Sensor Parameter Response to Injected Chemical Contaminants in Chlorinated Water – Single Pass DSS

Chemical Contaminants	Initial In-Pipe Concentration (mg/L)	Free Chlorine	Total Chlorine	Chloride (Cl ⁻)	Specific Conductance	Dissolved Oxygen (DO)	Oxidation Reduction Potential (ORP)	pH	Turbidity
Aldicarb	0.2	-31.6	-20.2	3.5	1.2	-0.5	-2.1	2.1	2.5
	1.1	-101.0	-155.1	-5.3	0.0	-3.6	-9.8	0.5	4.8
	2.2	-309.2	-216.6	6.3	0.0	0.3	-40.6	-1.9	-1.1
Glyphosate	0.4	-90.2	-40.0	4.6	-0.0	4.1	0.6	-1.3	6.0
	1.5	-275.7	-97.6	11.7	-5.4	3.8	-14.4	-28.5	2.2
	3.0	-380.3	-130.4	14.9	-0.3	2.8	-34.1	-108.4	-0.8
Colchicine	0.4	-4.7	0.5	0.1	1.5	0.8	2.7	4.4	2.6
	1.8	-7.2	-9.8	0.1	3.2	-0.2	-4.4	3.6	4.5
	3.6	-19.6	-9.4	-3.8	0.0	-3.0	-13.1	2.7	2.9
Dicamba	0.8	-5.9	-0.0	-5.7	-0.4	-7.4	7.2	-4.9	0.0
	1.3	-6.3	-5.4	-12.7	-3.1	-8.0	9.9	-9.4	-2.7
	2.6	-3.3	-0.5	-3.2	1.6	-6.6	11.4	-13.1	-2.5
Dimethyl Sulfoxide	0.6	-23.4	-22.1	-4.5	0.0	-6.2	4.1	4.8	0.7
	2.0	-52.5	-110.8	0.3	2.6	-8.1	-4.6	5.2	1.9
	4.0	-72.7	-115.3	1.9	0.4	-8.2	0.0	1.9	1.8
Lead Nitrate	0.6	-3.7	2.1	-7.5	0.3	2.2	2.4	-3.1	8.9
	0.7	-2.4	-11.3	-2.8	-1.9	-3.1	-0.4	-1.0	3.9
	1.4	-2.1	-4.0	-9.5	-0.5	0.5	-7.8	4.9	16.3
Mercuric Chloride	0.4	-6.1	-4.8	-4.7	-5.4	-0.3	3.4	-1.7	1.4
	1.1	-2.2	-4.3	-13.1	5.5	-1.7	8.9	-26.8	4.9
	2.2	-2.7	0.6	-10.0	1.7	-2.3	26.6	-33.0	0.7
Nicotine	0.4	-26.8	-10.0	2.0	1.0	3.6	-2.4	5.4	5.7
	1.9	-187.2	-43.0	-2.1	0.2	2.8	-20.1	8.5	0.6
	3.8	-243.6	-91.7	23.1	0.6	-2.4	-59.2	13.5	1.0
Potassium Ferricyanide	0.6	-7.8	-0.4	12.6	0.9	-2.9	3.4	2.3	2.1
	1.6	-7.5	13.1	58.3	4.9	-2.2	-3.0	-3.1	1.4
	3.2	-5.3	37.1	49.7	4.8	-0.9	-3.6	-5.7	0.4
Sodium Thiosulfate (Anhydrous)	0.2	-38.8	-37.0	3.9	4.2	-1.2	-1.9	2.6	3.6
	1.3	-235.1	-233.2	12.2	7.0	-0.3	-14.9	-6.5	3.4
	2.6	-158.4	-193.8	29.8	5.9	-2.5	-29.5	-4.3	3.3
Sucrose	0.6	-8.9	-1.6	-0.5	1.8	-0.1	3.5	0.6	0.1
	1.8	-6.0	-2.7	-4.6	0.4	-10.4	6.0	-1.8	1.0
	3.6	-4.8	1.0	-5.0	0.2	-3.4	4.0	-2.5	3.0
Control Blank	0	2.3	4.9	3.2	3.2	2.0	4.0	2.7	5.7
	0	2.0	0.6	0.5	2.5	1.5	2.2	0.7	1.9
	AVG ^a	2.2	2.7	1.9	2.9	1.8	3.1	1.7	3.8

■ indicates that the normalized, S/N corrected change was >10 of the baseline within 15 minutes.

^a Average of two control blank runs. Data presented in this table was not corrected to accommodate for the control blank response.

Table 5.4 Percent Change in Sensor Parameter Response to Injected Biological Contaminants and Growth Media in Chlorinated Water – Single Pass DSS

Biological Contaminants and Growth Media	Initial In-Pipe Concentration (mg/L)	Free Chlorine	Total Chlorine	Chloride (Cl ⁻)	Specific Conductance	Dissolved Oxygen (DO)	Oxidation Reduction Potential (ORP)	pH	Turbidity
Nutrient Broth	0.12	-1.4%	-2.2%	0.1%	0.9%	-2.3%	-1.1%	-0.2%	-20.7%
	0.48	-9.1%	-4.1%	-0.1%	0.2%	-0.5%	-1.4%	-0.1%	-14.1%
	0.96	-21.6%	-6.4%	1.1%	0.2%	-1.6%	-1.1%	-0.1%	3.3%
Trypticase Soy Broth	0.12	-6.7%	-4.6%	-1.1%	0.2%	-0.2%	-0.1%	-0.1%	60.0%
	0.48	-13.4%	-9.3%	-0.3%	-0.0%	0.1%	-2.0%	-0.2%	0.4%
	0.96	-20.4%	-13.0%	0.2%	0.1%	-0.4%	-4.4%	-0.0%	0.0%
Terrific Broth	0.12	-3.0%	1.0%	2.7%	0.0%	0.8%	0.5%	0.2%	15.3%
	0.47	-13.8%	-3.6%	-1.0%	-0.1%	-0.1%	-0.4%	0.2%	-19.3%
	0.97	-25.5%	-6.4%	-0.7%	0.1%	-0.2%	-1.2%	0.5%	-3.0%
<i>E. coli</i> in Terrific Broth	0.01	-20.1%	-7.0%	1.8%	0.1%	-0.9%	-1.9%	0.1%	170.8%
	0.07	-70.5%	-12.4%	4.6%	0.3%	-0.7%	-5.8%	-0.6%	192.5%
	0.14	-89.2%	-9.6%	10.7%	0.8%	-0.9%	-7.6%	-1.3%	296.9%
Control Blank	0	2.4%	1.6%	5.5%	0.5%	0.5%	1.8%	0.2%	52.5%
	0	1.0%	0.2%	0.6%	1.1%	1.0%	2.0%	0.1%	71.8%
	AVG ^a	1.7%	0.9%	3.1%	0.8%	0.8%	1.9%	0.2%	62.1%

■ indicates that the percent change was >10% of the baseline within 15 minutes.

^a Average of two control blank runs. All data presented in this table was corrected to accommodate for the expected average control blank response.

Table 5.5 Normalized, Signal-to-Noise Corrected Sensor Parameter Response to Injected Biological Contaminants and Growth Media in Chlorinated Water – Single Pass DSS

Biological Contaminants and Growth Media	Initial In-Pipe Concentration (mg/L)	Free Chlorine	Total Chlorine	Chloride (Cl ⁻)	Specific Conductance	Dissolved Oxygen (DO)	Oxidation Reduction Potential (ORP)	pH	Turbidity
Nutrient Broth	0.12	-9.4	-4.4	0.5	4.9	-0.6	-4.2	-3.5	-2.4
	0.48	-13.3	-13.8	-0.4	0.6	-1.1	-11.6	-2.9	-1.3
	0.96	-38.2	-18.6	6.1	3.0	-3.1	-18.8	-3.2	1.3
Trypticase Soy Broth	0.12	-8.7	-12.8	-3.5	0.7	-0.1	-1.4	-1.9	1.8
	0.48	-20.2	-31.8	-1.7	-3.7	1.2	-26.7	-5.5	-0.4
	0.96	-24.0	-25.8	0.2	0.4	-1.1	-47.7	1.8	0.0
Terrific Broth	0.12	-6.4	0.8	2.6	-1.4	2.6	3.4	1.8	1.0
	0.47	-43.2	-4.8	-3.8	-1.0	1.1	-7.4	4.0	0.5
	0.97	-65.6	-9.7	-6.2	1.4	1.1	-16.4	6.7	0.7
<i>E. coli</i> in Terrific Broth	0.01	-21.2	-15.9	2.2	1.0	-2.8	-34.4	0.5	2.1
	0.07	-127.5	-20.2	5.8	2.5	-2.0	-51.0	-10.0	2.2
	0.14	-153.6	-29.0	5.6	5.7	-3.2	-59.6	-22.6	2.8
Control Blank	0	2.3	4.9	3.2	3.2	2.0	4.0	2.7	5.7
	0	2.0	0.6	0.5	2.5	1.5	2.2	0.7	1.9
	AVG ^a	2.2	2.7	1.9	2.9	1.8	3.1	1.7	3.8

■ indicates that the normalized, S/N corrected change was >10 of the baseline within 15 minutes.

^a Average of two control blank runs. All data presented in this table was corrected to accommodate for the expected average control blank response.

Table 5.6 Percent Change in Sensor Parameter Response to *B. globigii* Injection in Chlorinated Water – Single Pass DSS

<i>B. globigii</i>	Initial In-Pipe Concentration	Free Chlorine	Total Chlorine	Specific Conductance	Oxidation Reduction Potential (ORP)	Turbidity
Unwashed	1.9E+05 ^b	-19.0%	-12.0%	0.2%	-1.3%	-100.0%
Washed	2.4E+04 ^b	-3.7%	-2.5%	-0.1%	-0.3%	-100.0%
Control Blank	AVG ^a	1.7%	0.9%	0.8%	1.9%	62.1%

■ indicates that the percent change was >10% of the baseline within 15 minutes.

^a Average of two control blank runs. Data presented in this table was not corrected to accommodate for the control blank response.

^b Concentration in Cells/mL.

Table 5.7 Normalized, Signal-to-Noise Corrected Sensor Parameter Response to *B. globigii* Injection in Chlorinated Water – Single Pass DSS

<i>B. globigii</i>	Initial In-Pipe Concentration	Free Chlorine	Total Chlorine	Specific Conductance	Oxidation Reduction Potential (ORP)	Turbidity
Unwashed	1.9E+05 ^b	-27.3	-37.7	4.5	-11.3	-2.4
Washed	2.4E+04 ^b	-10.7	-6.8	0.8	-3.1	-0.1
Control Blank	AVG ^a	2.2	2.7	2.9	3.1	3.8

■ indicates that the normalized, S/N corrected change was >10 of the baseline within 15 minutes.

^a Average of two control blank runs. Data presented in this table was not corrected to accommodate for the control blank response.

^b Concentration in Cells/mL.

was set at 2 mg/L (measured as total chlorine). The background values of other measured water quality parameters are the same as mentioned previously in Section 5.1.1. Table 5.8 shows the quantitative sensor responses to contaminants injected in DSS Loop No. 6 as absolute change, percent change, and S/N

ratio. Also, Table 5.8 shows that the TOC parameter responded to each contaminant except sodium arsenite, which was expected since sodium arsenite is not an organic (carbon-containing) compound. The TOC sensor responses are comparable to those observed during the same injections in the chlorinated GCWW

Table 5.8 Quantitative Sensor Parameter Response Matrix to Contaminants in Chloraminated Cincinnati Tap Water

Chemical Contaminants	Initial In-Pipe Concentration	Total Organic Carbon	Total Chlorine	Chloride	Ammonia Nitrogen	Nitrate Nitrogen	Specific Conductance	Oxygen Reduction Potential	pH	Turbidity
	(mg/L)	(mg/L)	(mg/L)	(mg/L)	(mg/L)	(mg/L)	(μ S/cm)	(mV)		(NTU)
Glyphosate (Roundup®)	1	0.27 ^a 127.5% 15.7	-0.04 1.6% 2.8	N/A ^b	0.1 1.0% 2.7	6.33 3.8% 6.1	5.16 0.9% 10.0	N/A	-0.02 0.2% 3.1	0.56 111.1% 46.2
Malathion (Real Kill®)	1	0.40 38.2% 54.7	-0.04 1.8% 2.1	5.2 7.7% 3.8	0.08 1.5% 1.5	12.85 6.1% 12.9	2.11 0.3% 4.8	-5.6 1.7% 8.0	0.03 0.3% 4.8	0.46 112% 43.1
Phorate	1	0.22 18% 48.4	-0.22 9.5% 60.0	N/A	-0.04 1.5% 0.4	8.73 17% 34.1	2.57 0.6% 7.1	-7.7 2.2% 16.2	-0.02 0.2% 3.4	0.29 74.9% 11.5
Wastewater	0.8v/v ^c (2 gallons)	0.18 13.8% 34.0	-0.04 1.6% 5.7	N/A	0.06 2.1% 0.5	29.73 11.1% 27.8	18.13 3.7% 28.4	-7.0 4.8% 6.2	-0.05 0.5% 7.2	0.43 116% 23.1
Sodium Arsenite	1	0.02 1.7% 3.8	-0.31 14.6% 48.6	20.7 9.5% 4.7	0.29 4.8% 2.7	4.22 1.7% 1.7	0.94 0.2% 1.7	-74.2 23.9% 84.2	0.05 0.6% 6.9	0.53 139% 9.3
Nicotine	10	2.71 963% 269.8	-0.02 0.8% 5.6	2.3 1.7% 6.6	N/A	1.13 9.2% 4.5	3.05 0.6% 5.3	-10.3 2.8% 18.0	0.02 0.3% 5.1	1.55 505% 173.3
Control Blank	0	0.02 1.7% 2.1	-0.01 0.4% 2.0	0.00 0.0% 0.0	0.03 1.1% 2.8	0.01 0.1% 0.2	4.35 0.9% 8.4	-1.0 0.3% 0.0	-0.02 0.3% 5.3	0.73 160% 19.5

^a Top values in each cell are the magnitude of the change, middle values are percent change, and bottom values are signal-to-noise ratio.

^b N/A indicates a problem with the probe or SCADA system that rendered the data invalid.

^c Two gallons of wastewater were injected, which represents 0.8 percent of the loop volume.

water. Responses were also similar for other sensors, except total chlorine. Total chlorine, as a measure of chloramines, showed little change for the contaminants tested, except for decreases of 0.22 mg/L (9.5 percent decrease, S/N: 60) and 0.31 mg/L (14.6 percent decrease, S/N: 48.6) for phorate and sodium arsenite, respectively.

However, since chloramines (mostly monochloramine) react more slowly with the injected organic contaminants than with free chlorine, the changes reported in Table 5.8 occurred over a period of four hours. In comparison, the free chlorine values changed almost instantaneously when the same contaminants were introduced into DSS Loop No. 6. So it is important to note that the changes in Table 5.8 are not necessarily comparable to those presented in the previous section. Furthermore, the slow changes in chloramine levels (measured as total chlorine) might prevent the person (or automated computer algorithm analyzing this data) from detecting a significant change unless the time window for this type of analysis was appropriately adjusted to account for the delay (Szabo et al., 2006 and 2008a; Kroll and King 2007).

5.1.3 Edgewood Chemical and Biological Center Test Loop Data Analysis

The data tabulated and reported in this section was generated by injecting selected contaminants (as listed in the individual tables) into the recirculating ECBC Test Loop with chlorinated water supplied by the City of Aberdeen Department of Public Works (Aberdeen, Maryland). The sensor responses to introduction of chemical warfare agents in the recirculating ECBC Test Loop are presented in Tables 5.9 (% change) and 5.10 (S/N). The ECBC Test Loop is similar to DSS Loop No. 6 described in Section 2.1.2. Both Tables 5.9 and 5.10 indicate that TOC and free/total chlorine are good detection parameters for all injected contaminants. Also, the small changes to pH result in a low percent change, but S/N data analysis presented in Table 5.10 shows that pH is a very good detection parameter for the warfare agent contaminants, given that the baseline is very stable.

The data presented in Sections 5.1.1 through 5.1.3 clearly indicates the usefulness of analyzing data in a qualitative and/or quantitative fashion, but the analyst should be aware of the usefulness and pitfalls of each selected approach. In addition, the professional judg-

Table 5.9 Percent Change in Sensor Parameter Response to Injected Warfare Agents in Chlorinated Water – Edgewood Chemical and Biological Center Test Loop

Injected Agent	Initial In-Pipe Concentration (mg/L)	Free Chlorine	Total Chlorine	Total Organic Carbon (TOC)	Specific Conductance	Oxidation Reduction Potential (ORP)	pH	Turbidity
V-series Nerve Agent	0.02	-5.7%	-9.9%	43.8%	1.1%	N/A	1.1%	-14.3%
	0.2	-20.2%	-19.0%	20.4%	0.4%	N/A	-1.3%	-7.8%
	2.0	-58.8%	-48.3%	135.4%	0.9%	N/A	2.5%	-4.0%
G-type Nerve Agent	0.02	-4.7%	-4.6%	15.3%	0.3%	N/A	3.6%	-6.5%
	0.2	-14.3%	-7.5%	20.4%	1.6%	N/A	3.8%	-12.7%
	2.0	-13.2%	-7.3%	82.9%	1.0%	N/A	5.7%	-9.7%
Ricin	0.25	-40.2%	-18.3%	12.9%	1.6%	-0.2%	-0.7%	1.0%
	0.25	-21.4%	-13.8%	14.3%	1.0%	N/A	1.2%	-0.2%
	0.25	-29.1%	-14.5%	20.8%	2.2%	N/A	3.1%	-8.4%
Potassium Cyanide	0.2	-90.6%	-68.4%	21.3%	1.4%	-8.9%	2.5%	1.7%
	0.2	-77.9%	-63.7%	10.0%	1.0%	-11.4%	4.0%	1.9%
	2.0	-98.7%	-98.5%	53.4%	5.6%	-59.8%	17.1%	7.5%

■ indicates that the percent change was >10% of the baseline within 15 minutes.

Table 5.10 Normalized, Signal-to-Noise Corrected Sensor Parameter Response to Injected Warfare Agents in Chlorinated Water – Edgewood Chemical and Biological Center Test Loop

Injected Agent	Initial In-Pipe Concentration (mg/L)	Free Chlorine	Total Chlorine	Total Organic Carbon (TOC)	Specific Conductance	Oxidation Reduction Potential (ORP)	pH	Turbidity
V-series Nerve Agent	0.02	1.4	13.4	647.4	7.1	N/A	5.9	38.3
	0.2	16.7	45.7	19.5	1.9	N/A	33.8	21.6
	2.0	47.7	45.5	41.0	3.8	N/A	7.1	8.0
G-type Nerve Agent	0.02	3.3	9.1	19.7	2.5	N/A	12.2	11.0
	0.2	9.8	16.7	20.3	6.6	N/A	16.2	25.3
	2.0	7.2	7.0	152.4	6.0	N/A	21.0	30.7
Ricin	0.25	17.6	17.8	21.3	8.6	1.5	10.2	1.4
	0.25	6.0	15.7	28.3	5.3	N/A	5.9	0.2
	0.25	21.4	16.3	41.6	8.3	N/A	14.5	12.0
Potassium Cyanide	0.2	35.5	69.7	17.0	10.1	44.8	9.7	1.8
	0.2	51.6	88.6	17.8	6.7	34.6	39.9	2.7
	2.0	56.9	119.3	184.8	25.4	89.3	80.5	6.4

■ indicates that the normalized, S/N corrected change was >10 of the baseline within 15 minutes.

ment of the analyst was used to define the usable significant change thresholds such as absolute change, percent change, and S/N ratio. For example, the peak sensor value used in the absolute change and subsequent calculations was computed based on values obtained between the time that the contaminant contacted the sensor and 15 minutes past that time. This definition of “time window” was not necessary for parameters like pH or conductivity, which respond within a minute. However, responses for parameters such as ORP develop more slowly and the maximum change might not be reached for an extended period. Hence, the definition of time window is necessary to utilize the full sensor response. Even though free/total chlorine parameters are good indicators, they might react slowly depending upon the injected contaminant and thus delay the observation of significant change in the disinfectant residual. This delay is much longer for chloraminated systems. Furthermore, the threshold at which a statistical parameter such as percent change or S/N ratio becomes significant or triggers a change alarm is based on the judgment of the analyst and the baseline water quality at the monitoring point. In general, absolute changes of 10% and S/N ratio of 10 were deemed adequate to iden-

tify the parameters best suited for detecting contamination events at the T&E Facility, but these numbers will vary depending on the variability of the baseline water quality data for a particular location. Ultimately, data analysis employing these techniques need to be automated and performed real-time for realizing any event detection benefits.

5.2 Automated Algorithmic Evaluation of Sensor Response

Based on the online data collected during the tests performed at the EPA T&E Facility and at the WSi field locations, EPA confirmed the need for automated data analysis tools. Specifically, this includes data analysis tools that can distinguish between normal variations in background water quality and changes in water quality triggered by the presence of contaminants (O’Halloran et al., 2009). Often referred to as event detection algorithms, such data analysis tools can read SCADA data (water quality signals, operations data, etc.), perform analysis in near real-time, and return an event value or code 0/1 (indicating the presence or absence of an alarm).

EPA collaborated with SNL to develop the open source CANARY software, which is intended to provide this capability. CANARY software is designed to accept standard water quality data and use mathematical algorithms to identify the onset of periods of anomalous water quality, while at the same time limiting the number of false alarms that occur. CANARY is trained on “normal” baseline water quality data by the user during the setup, and the configuration parameters are selected to accommodate the normal site-specific variability of water quality parameters. Therefore, these configuration parameters could vary from one utility to the next and might even vary across monitoring locations within a single utility. CANARY can be set up to receive data from a SCADA database, and return alarms to the SCADA system. In addition, it can be run “offline” on historical data to help set the configuration parameters (or train the algorithm) to provide the desired balance between event detection sensitivity and false alarm rates.

CANARY’s open source code is designed to be customizable, allowing outside researchers to develop new algorithms that can be added to CANARY. In the current version (Version 4.2), CANARY has three change detection algorithms: time series increments, a linear filter, and a multivariate nearest-neighbor algorithm. These algorithms identify a background “water quality signature” for each water quality sensor and compare each new water quality measurement to the background to determine if the new measurement is an outlier (anomalous) or not. The definition of the water quality background is updated continuously as new data become available. A binomial event discriminator (BED) examines multiple outliers within a prescribed time window to determine the onset of either an anomalous event or a change in the water quality baseline. Figure 5.1 shows the schematic operation of CANARY software.

In addition to the CANARY software, EPA has also tested the commercially available Hach Event Monitor™ Trigger System. Hach’s patented technology utilizes the Hach Event Monitor™ Trigger System to analyze five commonly measured water quality parameters monitored from the Hach WDMP (chlorine, pH, turbidity, conductivity) and the Hach astroTOC™ UV process TOC analyzer to estimate a water distribution system’s operating baseline (i.e., water quality under normal operating conditions). Thereafter, every minute, the Hach Event Monitor™ Trigger System analyzes the sensor data and computes a trigger signal, which indicates the level of deviation from the water quality baseline. If significant deviations occur, the trigger signal sends alarms to the operators in real-time. Once a deviation is detected, the Hach Event Monitor™ Trigger System signals the (optional) automatic water sampler to capture a water sample at

Water Utilities and Sensor Manufacturers

- Online monitoring data should be evaluated both qualitatively and quantitatively to identify which parameters provide significant change signals and have relatively stable baselines with low S/N ratio. These criteria should be factored into the selected algorithmic approach of data analysis.
- Free chlorine and TOC were found to be the most responsive trigger parameters in chlorinated systems. Total chlorine was not an effective trigger parameter in chloraminated systems. TOC or TOC surrogate monitoring should be considered for both chlorinated and chloraminated systems.
- To capture and evaluate sensor responses in real-time, SCADA equipment and algorithmic analysis are highly recommended. The SCADA database should be designed so that it can be easily interfaced with one or more automated algorithms for real-time analysis of data.
- Algorithms should be designed to learn or predict baseline values of parameters when monitoring location(s) with relatively unstable baseline conditions. Known routine system events (such as valve closures or tank fill and discharge cycles) need to be incorporated into the algorithmic evaluation(s) to reduce false positive events.
- For chlorinated systems, the algorithms and sensors should be designed to co-relate free chlorine and TOC data. Manufacturers should consider providing alarming or algorithm software with the online sensor equipment that is capable of identifying bad data and other instrument operational problems. This will prevent bad data from being analyzed by the algorithms, resulting in fewer false positive events.

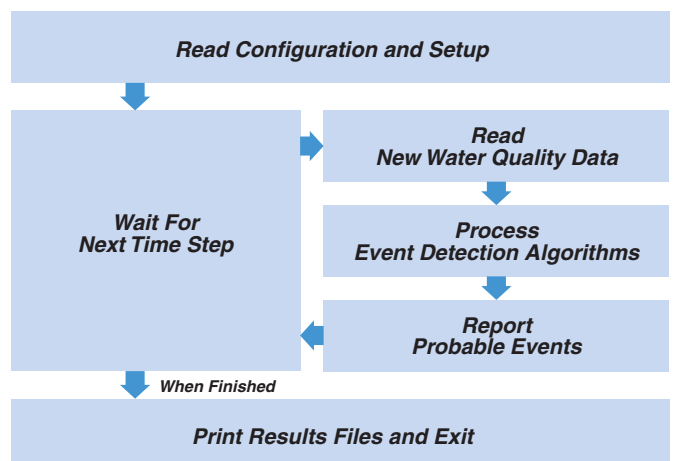

Figure 5.1 CANARY Operation Schematic

the designated monitoring location. The system subsequently compares the computed algorithmic values to the “Agent Library” and “Plant Library” to classify the deviation. The subscription-based “Agent Library” (Hach GuardianBlue™ Early Warning System) contains “fingerprints” for a wide variety of threat contaminants, ranging from V-series nerve agent (VX) and ricin to arsenic and herbicides. The site-specific operator-developed “Plant Library” contains “fingerprints” of operational and naturally occurring events specific to each water distribution system. The plant library can be used to detect and classify real-world events such as water main breaks, switching water sources, and caustic overfeeds.

EPA is also evaluating other commercial event detection technologies such as the Frontier Technology, Inc. (FTI) Event Detection Software (EDS) tool called H2O Sentinel™ for contaminant detection. FTI has developed a proprietary software to monitor a set of standard water quality parameters measured by sensor stations placed within a utility’s water distribution system and detect anomalous events that might be indicative of possible contamination incidents.

EPA plans to continue evaluating other commercially available event detection algorithms as they become available (Einfeld et al., 2007; Umberg et al., 2009). Because true contamination events are rare, the performance of event detection systems is difficult to evaluate. It is tempting to set the sensitivity of the algorithm at a low level so that few alarms are generated, since true contamination events are costly to investigate. However, high sensitivity algorithms can result in the generation of many alarms, which can result in “alarm fatigue.” EPA continues to evaluate the alarm prediction accuracy of these algorithms by simulating contamination events. EPA is considering the use of modified receiver operating characteristic (ROC) curves, a data classification methodology that can plot the fraction of true positive alarms versus the fraction of false positive alarms generated by the individual algorithm. Modified ROC curves can help determine the efficiency of these algorithmic approaches.

5.3 Data Analysis Best Practices

When the contaminant (or surrogate) injection tests were performed at the T&E Facility, the algorithmic approaches of data evaluation were not available, with the exception of the previously-mentioned ETV study. The qualitative approach, although robust, is not a viable technique for real-time event detection. There are normal/natural changes in water quality that could mimic some of the qualitative changes shown in the testing. For example, at a monitoring station near a storage tank or reservoir, the chlorine levels might change

dramatically depending upon the source of water and tank operation. Similarly, quantitative changes have a drawback: in real life, the concentration of the injected contaminants is unknown, and the resulting amount of change does not necessarily correlate with prescribed quantitative values. Therefore, an algorithmic approach is the preferred approach for event detection. However, a utility with existing SCADA systems (which generally allow for high-low alarm set points) in the process of deploying water quality monitoring stations can utilize significant threshold and other non-algorithmic methodologies described in this chapter to alert the local operator for further investigation. These types of preliminary data evaluations will assist in establishing and fine tuning parameter-specific change thresholds and time-windows for the algorithmic approaches. The evaluations of existing algorithms have so far demonstrated only limited success. Also, in an algorithmic approach, there is a need to optimize the sensitivity of the algorithm so that the false positives are minimized while retaining the algorithm’s ability to detect contamination events. EPA’s research for fine tuning individual algorithms and the search for new approaches are ongoing.

6.0 Operation, Maintenance and Calibration of Online Instrumentation

The capital costs of the equipment tested at the EPA T&E Facility are readily available from the manufacturers and are subject to change. However, the O&M costs are not as readily obtainable or well-defined. The experience gained at the T&E Facility indicates that, for most online sensors, O&M costs will quickly exceed capital costs. To keep the costs under control for the longer term, manufacturer recommendations should be followed when performing O&M activities. Also, maintenance requirements vary significantly, depending upon the parameter and the device. The online instrumentation evaluated at the T&E Facility was calibrated and maintained as needed for testing efforts described in the previous chapters. For year-round operation, maintaining a tight maintenance schedule is necessary to obtain optimal instrument performance. The scheduled maintenance activity, as well as cost of consumable(s), depends on the individual sensor.

This chapter describes general O&M activities and associated costs for the instruments evaluated at the T&E Facility. For this purpose, EPA tracked the labor and consumable costs required to operate and maintain the tested sensor equipment. The O&M costs presented here do not include travel time to service the individual monitoring locations. The travel costs will vary significantly, depending upon where service personnel are operating relative to the geographic distribution of the monitoring sites. Furthermore, the total labor cost will depend on operator skill and training, sensor complexity, service contract terms, and the number of sensor stations deployed. Based on discussions with utilities participating in the WSi, the optimal service requirement for a sensor station deployed to the field was determined to be one O&M site visit per month, with each visit taking less than four hours.

6.1 Operation & Maintenance Labor Costs

The labor hours expended for O&M vary significantly, depending upon the type of instrument used (or parameter that is monitored). As mentioned previously, the goal of the WSi's pilot implementation in Cincinnati was to achieve a service level of four labor hours per monitoring station per month. It was well understood that, during the initial phase of installation and shake-down, the labor costs were going to be much higher. Also, depend-

ing upon the size and complexity of an implementation, the shake-down period can range from a month to a year. The labor hours per instrument also vary significantly. Of the conventional instruments (TOC, chlorine, conductivity, pH/ORP and Turbidity), TOC instruments were by far the most labor intensive from an O&M perspective. They also required the highest technician skill level to operate and maintain. However, the TOC instruments are being continuously redesigned and the labor level required is expected to be lower in the coming years. Overall, the data collected from the WSi initiative (for a 10-month period between January and September 2008) showed that approximately 1.5 person(s) working on a full-time basis were needed to operate and maintain 17 monitoring stations. Between 60% and 80% of this labor cost was associated with the O&M for the TOC instruments. Also, as indicated previously, the labor hour estimate does not include travel time to the monitoring stations, which could vary significantly depending upon the geographic configuration of the monitoring network. Experience indicates that labor estimates per site can vary widely because there might be some sites with adverse water quality (or other site-specific anomaly) that can cause numerous O&M problems. The best current estimate for labor hours per site is 1.5 days per month on average, which is three times the goal of the WSi.

Additional labor costs will be incurred for data analysis and event detection efforts. Because it is too labor intensive to have the operator monitor the data on a continuous basis, an automated event detection or alarm system is necessary. It is expected that the existing SCADA operator at a water utility can be assigned the additional duty of checking the operational status of the data collection system during every shift to ensure that data is being collected and analyzed by automated tools. To ensure everything is operating normally, the utility should plan to assign a person to skim through the historical data and monitor the alarm software on a daily basis. This task is expected to add approximately 30 to 60 minutes per day or per shift depending upon how the task is assigned. The reviewer should be a staff member who already understands the operations and the monitored water quality data and can make decisions on O&M and alarm response needs as warranted by the quick review of the data and alarm history.

6.2 Equipment-Specific Maintenance and Consumable Costs

As mentioned previously, the maintenance requirements vary significantly, depending upon the parameter and the device. Based on the experience gained at the T&E Facility, EPA identified TOC, free chlorine, conductivity, pH/ORP, turbidity and temperature as the key online

monitoring parameters. These parameters are listed in the order of importance from an event detection perspective. The following sections (Section 6.3 through 6.7) describe these parameters (except temperature) and the instrument-specific O&M activity for the equipment evaluated at the T&E Facility. The temperature probes are inexpensive and very robust with almost no maintenance requirements and are, therefore, not discussed in this report. The prices for consumables for the instruments mentioned in this chapter are based on pricing information obtained during the years 2007 and 2008.

6.3 Total Organic Carbon Instrumentation

TOC instrumentation responded to a wide range of contaminants tested at the T&E Facility. Especially in chloraminated waters, TOC instrumentation was more responsive to contaminants than the instrumentation used for measuring total chlorine/monochloramines. A skilled technician was required to reliably operate and maintain the TOC instrumentation on a continuous basis, making it the most expensive and time-consuming equipment to operate. It is highly recommended that the person responsible for TOC instrumentation O&M issues obtain manufacturer-provided training, or the water utility should consider purchasing a manufacturer maintenance contract. EPA also evaluated an optical instrument (Carbo::lyzer™) that estimates TOC levels by measuring UV-Vis spectra between 200 and 750 nanometer (nm) wavelengths.

6.3.1 Hach astroTOC™ UV Process Total Organic Carbon Analyzer

This instrument requires monthly replenishment of reagents, quarterly scheduled maintenance, and approximately \$4,000 per year for consumables. The following routine maintenance activities need to be performed:

- Replace reagent/acid (monthly), reagent/oxidizer (quarterly)
- Change the pump tubing (quarterly)
- Replace the semi-permeable sparger membrane (quarterly)
- Replace the hydrophobic filter (quarterly)
- Calibrate the infra-red detector with carbon dioxide (quarterly)
- Calibrate the wet-side of the unit with potassium hydrogen phthalate (KHP) standard (monthly/quarterly)
- Replace the UV lamps (annually)
- Replace the consumables in the carrier gas generator (annually)

- Clean infra-red detector window (annually)

A significant amount of time was required for troubleshooting and repairing the Hach astroTOC™ UV Process Total Organic Carbon Analyzer, primarily due to instrument malfunctions. The types of malfunctions observed were mostly related to plugged or interrupted flow (liquid/gaseous):

- There was a build-up of silica crystals in the resample block, which was rectified by Hach by redesigning the resample block
- The sparger orifice would get plugged (semi-permeable membrane) and result in shut-down of the instrument

Monthly calibration is essential to electronically adjust for the instrument drift prior to the quarterly maintenance/calibration event.

6.3.2 Sievers® 900 On-Line Total Organic Carbon Analyzer

This instrument requires quarterly scheduled maintenance. Depending upon the initial water quality, maintenance costs can vary between \$2,000 and \$4,000 per year for consumables. The following routine maintenance activities need to be performed:

- Replace reagent/acid/oxidizer (quarterly/semi-annual)
- Change the pump tubing (semi-annual)
- Replace the resin bed (semi-annual)
- Replace UV lamp (semi-annual)
- Replace ICR degasser, chemical trap, and pump rebuilt kit (annual)
- Replace in-line particulate filter (annual)
- Replace oxidizer syringe (annual)
- Replace restrictor tubing (annual)

Comparatively, a significant amount of time was required for troubleshooting and repairing the Sievers® 900 On-Line TOC Analyzer, primarily due to instrument malfunctions. Malfunctions observed were mostly related to plugged or interrupted liquid flow (e.g., restrictor tube blockage). In areas with high-carbonate water, reagents need to be replenished quarterly.

6.3.3 Spectro::lyzer™/Carbo::lyzer™

As indicated earlier, this sensor is an optical instrument that estimates TOC levels by measuring UV-Vis spectra between 200 and 750 nm wavelengths. Only

TOC that has some absorption property in the specified wavelengths is detected. The instrument has minimal O&M requirements. At first, EPA procured a unit made of high-grade aluminum. However, the body of this instrument corroded in chlorinated Cincinnati tap water. A replacement stainless steel unit was provided by the manufacturer free of charge. EPA recommends that only a stainless steel unit be purchased for locations with water quality that might be aggressive to aluminum. The unit in global calibration mode does not require any calibration. If local TOC values are known, the unit can be calibrated using locally available high and low values. For obtaining a zero value in the local calibration mode, a highly-purified High-Performance (or High-Pressure) Liquid Chromatography (HPLC) grade reagent or a high grade distilled water should be used. Deionized and nanopure waters are not suitable for this purpose.

6.4 Chlorine Instrumentation

Free chlorine instruments responded to the majority of contaminants tested at the T&E Facility on chlorinated Cincinnati tap water. Both free and total chlorine instruments use either a reagent-based (colorimetric) method or a reagent-free method (amperometric/polarographic/galvanic – electrode/membrane-based). The reagent-free method has varied pH dependence, depending upon the use of buffering agents. The reagent-based method consumables include buffering and indicator solutions. The reagent-free method consumables include electrolyte solutions (and membranes, if applicable).

6.4.1 Hach CL-17 Free and Total Chlorine Analyzer

Hach CL-17 Free and Total Chlorine Analyzers both utilize the colorimetric method. Buffer and reagent solutions, which adjust the pH and react with chlorine to produce a color, are added to the sample. The color depth is proportional to the amount of chlorine. Buffer and reagent solutions last about a month. The estimated cost of the buffer and reagent solution consumables is between \$750 and \$1,000 a year. In addition, the tubing, stir-bar, and plastic-tube connectors need to be replaced every six months. The colorimeter needs to be cleaned every six months. This unit requires no calibration.

6.4.2 Wallace & Tiernan® Depolox® 3 plus

The Wallace & Tiernan® Depolox® 3 plus employs a reagent free (potentiostatic 3-electrode-amperometric) method for measurement. There is an option for either a bare electrode or membrane-type measurement. The option selection is based on water hardness, conductivity, and variation in pH. The membrane-type instrument is recommended for a higher pH range (6 to 10 pH usable range) and low conductivity (10 – 2,500 $\mu\text{S}/\text{cm}$) waters. In high pH waters, buffering (e.g., using CO_2) is needed.

Free chlorine consists of chlorine molecules (Cl_2), hypochlorous acid (HOCl) and hypochlorite ions (OCl^-). The presence of each component is mostly dependent upon pH with some influence of temperature. The HOCl component is the most effective component of free chlorine for disinfection. The electrodes typically measure the HOCl component, and report it as free chlorine. In membrane-type instruments, the membrane is designed to allow only the HOCl acid through the membrane, which is measured and reported as free chlorine. At a pH of > 8.5 , the majority of the HOCl is converted to OCl^- , thus, interfering with the accurate measurement of free chlorine. From a maintenance perspective, the following considerations are noted:

- Replace the electrolyte in the electrode reservoir (semi-annually)
- In the bare electrode model, replace the grit (that self-cleans the electrode) (semi-annually)
- In the membrane type model, clean the electrode tip with abrasive paper and replace the membrane (every three years)

The cost of consumables ranges between \$350 and \$1,000 a year. The calibration of the bare electrode is performed by turning the sample flow off and setting to zero (after waiting several minutes). The water is then turned back on, and after waiting for the reading to stabilize, a grab sample is collected, a *N,N*-diethyl-*p*-phenylenediamine measurement is performed and the span set to match the test result. For the membrane-type unit, there is zero calibration.

6.4.3 YSI 6920DW

The YSI 6920DW is a multi-parameter (free chlorine, turbidity, temperature, conductivity, pH, and ORP) instrument that uses a reagent-free (amperometric membrane) method for free chlorine measurement (similar to the instrument described in Section 6.4.2). From a maintenance perspective:

- Replace the electrolyte and membrane (quarterly)

The annual cost of consumables is approximately \$2,100 a year.

6.4.4 Analytical Technology, Inc., Model A15/62 Free Chlorine Monitor

The Analytical Technology, Inc., Model A15/62 free chlorine monitor instrument uses a reagent-free (polarographic membrane) method for free chlorine measurement (similar to the instrument described in Section 6.4.2).

- Replace the electrolyte and membrane (quarterly)

The annual cost of consumables is approximately \$100 a year. The consumable costs for this instrument are less expensive when compared to the Wallace & Tiernan® Depolox® 3 plus instrument, because there is no pH electrode to be replaced.

6.4.5 Rosemount Analytical Model FCL

The Rosemount Analytical Model FCL uses a reagent-free (membrane type amperometric) method for free chlorine measurement (similar to the instrument described in Section 6.4.2). In addition, the Rosemount Analytical Model FCL-01 (with manual pH adjustment) chlorine sensor can measure both HOCl and OCl⁻ forms of chlorine. The sensor responds differently to each form and compensates for both sample pH and temperature. From a maintenance perspective:

- Replace the electrolyte and membrane (quarterly)
- In addition, the membrane needs to be cleaned (monthly)

During the contaminant injections, this membrane appeared to be more prone to fouling than the other membrane-type instruments. The annual cost of consumables is approximately \$400 a year.

6.5 Conductivity Instrumentation

The presence of dissolved mineral substances such as chloride, nitrate, sulfate, and phosphate anions (ions that carry a negative charge) or sodium, magnesium, calcium, iron, and aluminum cations (ions that carry a positive charge) dissolved in water can be measured as conductivity (or temperature-compensated specific conductance). Conductivity is basically a measurement of the sample water's ability to carry an electrical current. There are several factors that affect the conductivity of water including: concentration of ions; mobility of ions; oxidation state (valence); and temperature. The testing at the T&E Facility indicated that a high volume of contaminant injection was needed for the conductivity value to change significantly. Conductivity is typically measured directly by either measuring the voltage drop or the current flow through a sample.

The performance of the conductivity probes was similar for the probes tested at the T&E Facility. The probes evaluated at the facility included the following: Hach/GLI Model C53 Conductivity Analyzer, YSI 6600, YSI 6920DW, Hydrolab® DS5 and Troll® 9000. From a maintenance perspective:

- These probes need to be cleaned and calibrated (quarterly)
- The probe requires replacement as needed (generally lasts at least a year)

The consumables include calibration solutions that cost approximately \$200 per year.

6.6 pH/ Oxygen Reduction Potential Instrumentation

The majority of the manufacturers combine the pH/ORP measurement with a reference electrode. The pH value is a measure of the activity of hydrogen ions (H⁺) in the water sample. Therefore, it is a measure of the degree of acidity or alkalinity of the water sample. ORP is a measure of the tendency of the water sample to oxidize or reduce another chemical substance. Typically, ORP is measured using an inert metal electrode (platinum), which will donate electrons to an oxidizing agent or accept electrons from a reducing agent. The ORP electrode continues to accept or donate electrons until it develops a potential that is equal to the ORP of the solution. ORP is sometimes utilized for estimating the concentration of chlorine in water. However, ORP measurement is affected by many factors and might not be a good surrogate for chlorine. The testing at the T&E Facility indicated that the ORP probes took longer than pH probes to return to baseline and grab samples for ORP are not reliable. The performance of the pH/ORP probes was similar for all of the probes tested at the T&E Facility. The probes evaluated at the facility included the following: Hach/GLI Model P53 pH/ORP Analyzer, YSI 6600, YSI 6920DW, Hydrolab® DS5 and Troll® 9000. From a maintenance perspective:

- These probes need to be cleaned and calibrated (quarterly)
- These probes require replacement as needed (generally lasts at least a year)
- The Hach/GLI Model P53 pH/ORP Analyzer requires annual replacement of the salt-bridge and electrolyte solution, which extends the instrument life to about 3 years.

The consumables include pH calibration solutions and probes that cost approximately \$1,000 per year.

6.7 Turbidity

Turbidity is a measure of cloudiness or haziness of the water sample caused by the suspended particles. Turbidity is typically determined by shining a light beam of wavelengths between 830 and 890 nm into the sample solution and then measuring the light (at 90-degrees) scattered by the suspended particles. Online nephelo-

metric turbidity measuring devices were evaluated. The turbidity sensors evaluated include the Hydrolab® DS5 and Hach FilterTrak™ 660 sc Laser Nephelometer. From a maintenance perspective:

- The Hach FilterTrak™ 660 sc Laser Nephelometer requires quarterly cleaning/calibration and annual replacement of the light source
- Hydrolab® DS5 turbidimeters require semi-annual replacement of the wiper

The Hydrolab® DS5 optical turbidimeter probes last about three years and cost approximately \$1,500 per unit. The annualized cost for consumables, including the optical probe and calibration solutions, is approximately \$1,000.

The annualized consumables cost for the Hach FilterTrak™ 660 sc Laser Nephelometer, including the bulb replacement and calibration solution, is approximately \$300.

6.8 Dissolved Oxygen

Dissolved oxygen probes are used to measure the amount of gaseous oxygen (O₂) dissolved in the water sample. Dissolved oxygen levels did not significantly change after the initial contaminant injections and therefore was removed from further evaluation.

6.9 Other Conventional Water Quality Parameter/Instrumentation

During the initial phases of testing at the T&E Facility, various other ion-selective electrodes (ISEs) were also evaluated for their efficacy and usefulness in detecting changes in water quality. The other ISEs evaluated for their ability to measure the following parameters: ammonia, nitrate, and chloride. Although some of these parameters changed in the presence of the contaminants, free chlorine interfered with ISE calibration and prevented the repeatability of the measurement. In addition, some of the ISEs burned out too quickly and were expensive to replace. Therefore, these parameters were excluded from further testing.

6.10 Online Optical Instrumentation

The following optical instruments (listed alphabetically) were evaluated mostly for their ability to detect biological agents and growth media at the T&E Facility: FlowCAM®, Hach 2200 PCX Particle Counter, Hach FilterTrak™ 660 sc Laser Nephelometer, BioSentry®, Spectro::lyzer™ and Carbo::lyzer™ and

ZAPS MP-1. In addition, because of their ability to detect contaminants in addition to biological organisms, the Spectro::lyzer™ and Carbo::lyzer™ and the ZAPS MP-1 were tested using various chemical injections. Generally, the biological organism tests were performed by injecting 100, 600, 1,000, and 25,000 cells/mL (both in chlorinated and dechlorinated waters). Based on previous testing, EPA had discovered that the online chlorine and TOC monitors generated reliable responses at injections of 100,000 cells/mL and some responses at 25,000 cells/mL, but the response faded below this level.

Generally, these optical instruments were evaluated as they became available for the research and, therefore, evaluations utilizing all contaminants with each instrument were not performed. The following is a brief summary of their capability and equipment performance observation.

6.10.1 FlowCAM®

FlowCAM® is an online particle imaging and flow-cytometry system that takes high-resolution digital images of particles and cells in the water sample. The images are analyzed by a proprietary software program based on Microsoft® Office Excel® that captures and analyzes the parameters of the particles such as count, size, length, shape, and equivalent spherical diameter. In addition, the instrument captures the intensity, transparency, color, bio-volume, compactness, roughness, and elongations of the particles.

At the T&E Facility, *Ankistodesmus* (20 to 100 micrometers (µm)), *Selenestrum* (10 µm), and *Saccharomyces* yeast (1.5 µm) were injected. The unit was able to recognize all of the particles. In order to capture individual images, the flow cytometry setup significantly reduces the flow volume to the unit. This restrictive flow path causes significant delays in the measurement from the injection time. At concentrations below 1,000 cells/mL, the instrument is unable to differentiate baseline noise from injected contaminants. Sub-micron particles such as *E. coli* (0.8 to 0.9 µm), bacteriophage MS2 (0.02 to 0.03 µm) and *B. globigii* (0.5 to 0.9 µm – spores are smaller than the cells) were not identifiable with the existing camera optical resolution and flow cell. However, at sufficiently high concentrations, the instrument is able to show an increased count.

6.10.2 Hach FilterTrak™ 660 sc Laser Nephelometer and Hach 2200 PCX Particle Counter

The Hach FilterTrak™ 660 laser nephelometer uses a collimated light source with high beam density and a distinct wavelength to detect baseline turbid-

ity change as low as 0.5 milli-nephelometric turbidity units (mNTU) (0.0005 NTU). The instrument is optimized to detect particles in the 0.1 to 0.5 μm range. The Hach 2200 PCX Particle Counter is a laser-diode-based particle counter designed for drinking water applications. The instrument is optimized to detect particles in the range of 2-750 μm .

The instruments were challenged with the following biological injections performed at the T&E Facility: *E. coli*, MS2 and *B. globigii*. The Hach Filter/Trak™ 660 sc Laser Nephelometer was able to detect only *E. coli* and *B. globigii* at injection levels of 25,000 cells/mL. The Hach 2200 PCX Particle Counter was unable to detect any of the biological injections at these levels. The particle counter is designed for detecting larger biological particles such as *Cryptosporidium* spp. and *Giardia lamblia*.

6.10.3 BioSentry®

The BioSentry® system is a laser-based, continuous, online, real-time monitoring device for detecting microorganisms in water. The unit utilizes laser-produced, multi-angle light scattering (MALS) technology to generate unique bio-optical signatures for classification using BioSentry®'s pathogen detection library. BioSentry® can be set up to detect microorganisms and identify suspected pathogens.

The biological injections performed at the T&E Facility included the following: 3-micron beads (surrogates for *Cryptosporidium* spp.), *B. globigii* and *E. coli*. In the current design (as tested), the unit has to be programmed to identify a specific contaminant, whereas all others (even when detected) are identified as unknowns. Prior to any injection(s), the unit should be programmed to recognize the injected particle, i.e., the unique bio-optical MALS signature should be developed and put to use (using the local water and pure form of the injected particle). The unit tested at the T&E Facility was able to reliably recognize injection events and identify injected particles between 1,000 and 10,000 cells/mL level. At lower cell concentrations, the detection was not consistent across the test runs.

6.10.4 Spectro::lyzer™/Carbo::lyzer™

These units are based on UV-Vis spectroscopic absorption measurements. Contaminants that respond to the UV-Vis absorption spectra can be detected by this instrument. The Spectro::lyzer™ was programmed to measure the optical equivalents of turbidity, nitrate, TOC, and dissolved organic carbon (DOC). In addition, the Spectro::lyzer™ was connected to the con::stat™ process control terminal, which ran the proprietary software to compute four pre-set alarm parameters based

on computations of spectral channels that were considered to be important by the manufacturer.

At the T&E Facility, both chemical and biological injections were performed using the Single Pass DSS. The chemical injections included: humic acid, sodium fluoroacetate, aldicarb, dicamba, and gasoline. The instrument was able to detect the water quality changes for all of the contaminants, except sodium fluoroacetate. The biological injections included the following: sucrose, *E. coli* and *B. globigii*. The instrument was able to detect changes at injection levels of approximately 25,000 cells/mL.

Results at the T&E Facility indicated that this device was capable of serving as a good surrogate for traditional TOC measurement. The operation and maintenance requirements for this device were minimal when compared to the traditional UV-persulfate method-based TOC measuring devices. Also, the size of this device is much smaller than the traditional TOC measuring devices. As mentioned previously in Chapters 2, 3, and 5, TOC is a critical water quality trigger parameter. EPA recommends the use of this type of device especially at locations where the traditional TOC devices are difficult to deploy, either due to size or due to ongoing operational and maintenance costs. Subsequently, the Carbo::lyzer™ was successfully deployed at two locations under the WSi pilot study in Cincinnati alongside the traditional TOC measuring devices. Furthermore, this instrument and associated software are capable of analyzing the full spectrum of UV-Vis absorbance, which if fully exploited, can yield additional information about the water quality changes that are not captured by the other devices evaluated by EPA at the T&E Facility.

6.10.5 ZAPS MP-1

The ZAPS MP-1 is an online water quality monitoring device that can be programmed to measure up to 100 slices of optical wavelengths (using optical filters) between 200 and 800 nanometers. The optical data that can be captured includes absorption, fluorescence, and total reflection bands. The ZAPS MP-1 configuration at the T&E Facility was set up to measure the following parameters: dark counts, pinhole, nitrate, ultraviolet 254 nanometer wavelength (UV₂₅₄) absorbance, bacterial fluorescence, humic fluorescence, total fluorescence, rhodamine, and transmission. The individual excitation and response wavelengths were pre-set by the manufacturer to these parameters.

At the T&E Facility, nitrate, formazin, *Saccharomyces cerevisiae* (yeast) and *E. coli* were injected to evaluate responses on this instrument. The instrument responded well to nitrate injections at 0.14 mg/L. The instrument responded well to the injection of formazin (tur-

bidity standard) at test levels of 13.3 NTU and 26.6 NTU; a linear response was observed in UV₂₅₄, total fluorescence, bacterial fluorescence, and nitrate channels. However, for *Saccharomyces cerevisiae* (yeast) and *E. coli* injections, the instrument showed no response below 100,000 cells/mL. Therefore, no further testing was performed with the biological agents.

6.11 Best Practices and Lessons Learned

As presented in Sections 6.1 through 6.9, many conventional instruments are relatively easy to operate and maintain. However, the TOC instruments are more complex and require a relatively higher level of technical skill. A formal training class provided by the manufacturer for each type of instrument is highly recommended. Just by following the instruction manuals, experienced instrumentation technicians and field engineers who have several years of experience are usually capable of installing, setting up, calibrating, and operating new or unfamiliar instrumentation. Less experienced staff will require assistance from the instrument manufacturer to avoid some of the pitfalls that can cause serious damage to an instrument and result in improper/inefficient operation. For example, the Sievers® 900 On-Line TOC Analyzer requires the de-ionized loop reservoir to be filled prior to power up; otherwise, air is trapped in the measurement modules, which will require factory service. Furthermore, factory default settings for an instrument might not be suitable for the location; the operator should be aware of the exact settings for each location prior to service. As another example, when installing a probe to an analyzer such as Wallace & Tiernan® Depolox® 3 plus, it is necessary to complete a formal setup in the instrument analyzer to recognize the probe correctly. It is always advisable to attend training workshops offered by most instrument manufacturers. Adequate staff training for setup and maintenance activities is essential for optimal operations. In addition, for more complex instruments (such as the optical instrumentation), it is essential for the maintenance technician to receive formal manufacturer training.

The operation of a single or a few instruments is a relatively straightforward process; however, the operation of a multi-station network or multiple networks can be a logistical nightmare. Loss of data, false alarms, and other malfunctions can lead to improper analysis of data by algorithms and inappropriate actions. The operator should consult with the instrument manufacturer(s) and develop a thorough understanding of the instrument outputs during power outages and other malfunctions such as the loss of reagents. It is important to develop a monitoring plan for sched-



Water Utilities and Sensor Manufacturers

- Over the life of the equipment operation, in general, the O&M cost will exceed capital cost for most online sensing equipment. At a minimum, the water utilities should set aside a budget for annual labor and consumable costs, based on the detailed information presented in this chapter.
- The evaluations at the EPA T&E Facility and during the WSi pilot study revealed that almost 60% to 80% of the O&M labor cost associated with the water quality monitoring sensors was related to TOC instruments.
- Instrument technicians should be appropriately factory-trained for optimal operations.
- O&M activities should be appropriately scheduled. Consumables should be purchased in a timely manner so that they do not expire before they can be used up.
- Ideally, sensor manufacturers need to develop reagent-free sensors that result in lower labor and consumable costs.
- In the absence of better TOC instrumentation, TOC surrogate monitoring (such as the S::CAN – see section 6.10.4) should be seriously considered for both chlorinated and chloraminated systems as the maintenance requirement for this type of device is minimal.

uled maintenance, order expendable supplies in a timely manner, maintain calibration standards, and schedule sufficient manpower to cover network operations. Following a good monitoring plan will ensure the collection of high-quality data that meets the monitoring requirements.

In general, most instrument problems are related to flow (sample and/or reagent issues). The sample flow problem could be related to restrictions in the flow manifold or restriction of flow through the instrument. Reagent flow blockage can result in diminished or unstable readings. If the reagents run out completely, the readings typically drop to zero and are easy to spot. Some instruments are factory-set to hold the last good reading; if the numbers do not change over a significant period, it is an indication of instrument failure. For membrane-type probes, the reading usually drifts downwards as the membrane is clogged or nearing its useful life. For electrodes, failure is generally indicated by problems during calibration where either the slope or the gain or the cell constant is outside of the manufacturer-recommended tolerance range.

Degassing or bubbles can cause improper readings. Degassing is generally an issue where the incoming sample water is colder than the environmental housing of the instrument.

When purchasing consumables, one needs to be sure to use them prior to their expiration dates. For some ISEs, the shelf life begins from the date of manufacture and not the date of installation. When planning to purchase spare parts and consumables, the shelf life and projected use by date should be taken into consideration. Water utilities are encouraged to work with manufacturers to negotiate purchase price of equipment based on volume of purchase and any negotiated long-term service contracts.

7.0 Bibliography

The references included in this bibliography contain additional detailed information for readers who wish to pursue, in greater detail, the specific topics discussed in this guide. Many of these references (especially the EPA references) are freely available on the Internet. The references are listed alphabetically, based on the last name of the first author(s). In cases where there are two or more works by the same author (e.g., EPA), the entries are listed chronologically.

Allgeier, S.C., J. Pulz, and R. Murray, 2006. Conceptual design of a contamination warning system. Proceedings of the AWWA Water Security Congress, Washington, DC.

AwwaRF, 2002. Online monitoring for drinking water utilities. Editor, Erika Hargesheimer, Awwa Research Foundation and CRS PROAQUA, American Water Works Association, Denver, CO.

Dawsey, W.J., B.S. Minsker, and V.L. VanBlaricum, 2006. Bayesian belief networks to integrate monitoring evidence of water distribution system contamination. *Journal of Water Resources and Planning*, ASCE, 132:4:234.

Department of Homeland Security, 2006. *National Infrastructure Protection Plan*.

Edberg, S. C., E.W. Rice, R. J. Karlin, and M. J. Allen, 2000. *Escherichia coli*: The Best Biological Drinking Water Indicator for Public Health Protection. *Journal of Applied Microbiology*, 88 (S6).

Einfeld, W., S. McKenna, and M.P. Wilson, 2008. A Simulation Tool to Assess Contaminant Warning System Sensor Performance Characteristics. AwwaRF, Denver, CO.

EPA, 2003. Contamination threat management guide - Module 2. EPA/817/D-03/002, Washington, DC.

EPA, 2004a. *The Water Security Research and Technical Support Action Plan*. EPA/600/R-04/063, Washington, DC.

EPA, 2004b. *Public Drinking Water Systems Programs*: <http://www.epa.gov/safewater/pws/pwss.html>.

EPA, 2004c. *Response Protocol Toolbox Overview*. EPA/817/D-03/007, Washington, DC.

EPA, 2004d. *Response Protocol Toolbox: Water Utility Planning Guide - Module 1*. EPA/817/D-03/001, Washington, DC.

EPA, 2004e. *Response Protocol Toolbox: Contamination Threat Management Guide - Module 2*. EPA/817/D-03/002, Washington, DC.

EPA, 2004f. *Response Protocol Toolbox: Site Characterization and Sampling Guide - Module 3*. EPA/817/D-03/003, Washington, DC.

EPA, 2004g. *Response Protocol Toolbox: Analytical Guide - Module 4*. EPA/817/D-03/004, Washington, DC.

EPA, 2004h. *Response Protocol Toolbox: Public Health Response Guide - Module 5*. EPA/817/D-03/005, Washington, DC.

EPA, 2004i. *Response Protocol Toolbox: Remediation and Recovery Guide - Module 6*. EPA/817/D-03/006, Washington, DC.

EPA, 2004j. *Response Protocol Toolbox: Planning for and Responding to Drinking Water Contamination Threats and Incidents Response Guidelines*. EPA/817/D-04/001, Washington, DC.

EPA, 2004k. *Homeland Security Strategy*. Washington, DC.

EPA, 2005a. *Evaluation of Water Quality Sensors as Devices to Warn of Intentional Contamination in Water Distribution Systems*. EPA/600/R-05/105, Washington, DC. Available only through WaterISAC.

EPA, 2005b. *WaterSentinel Online Water Quality Monitoring as an Indicator of Drinking Water Contamination*. EPA/817/D-05/002, Washington, DC.

EPA, 2005c. *WaterSentinel System Architecture*. EPA/817/D-05/003, Washington, DC.

EPA, 2005d. *Technologies and Techniques for Early Warning Systems to Monitor and Evaluate Drinking Water Quality: A State-of-the-Art Review*. EPA/600/R-05/156, Washington, DC.

EPA, 2007a. *Water Quality Sensor Response to Contamination in a Single Pass Water Distribution System Simulator*. EPA/600/R-07/001, Washington, DC. Available only through WaterISAC.

- EPA, 2007b. *Water Security Initiative: Interim Guidance on Planning for Contamination Warning System Deployment*. EPA/817/R-07/002, Washington, DC.
- EPA, 2008a. *Water Security Initiative: Interim Guidance on Developing an Operational Strategy for Contamination Warning Systems*. EPA/817/R-08/002, Washington, DC.
- EPA, 2008b. *Water Security Initiative: Interim Guidance on Developing Consequence Management Plans for Drinking Water Utilities*. EPA/817/R-08/001, Washington, DC.
- EPA, 2008c. *Water Security Initiative: Cincinnati Pilot Post-Implementation System Status - Covering the Pilot Period: December 2005 through December 2007*. EPA/817/R-08/004, Washington, DC.
- Hall, J.S., A.D. Zaffiro, R.B. Marx, P.C. Kefauver, E.R. Krishnan, R.C. Haught, and J.G. Herrmann, 2007. On-line water quality parameters as indicators of distribution system contamination. *Journal of American Water Works Association*, 99:1:66.
- Homeland Security Presidential Directive-7/HSPD-7, 2003. *Critical Infrastructure Identification, Prioritization, and Protection*: http://www.dhs.gov/xabout/laws/gc_1214597989952.shtm.
- Homeland Security Presidential Directive-9/HSPD-9, 2004. *Defense of United States Agriculture and Food*: http://www.dhs.gov/xabout/laws/gc_1217449547663.shtm.
- ISLI, 1999. *Early warning monitoring to detect hazardous events in water supplies*. ISLI Press, Washington, DC.
- Kessler, A., A. Ostfeld, and G. Sinai, 1998. Detecting accidental contaminations in municipal water networks. *Journal of Water Resources Planning and Management-ASCE*, 124:4:192.
- Kirmeyer, G., M. Friedman, and K. Martel, 2002. Guidance manual for monitoring distribution system water quality. Awwa Research Foundation, Denver, CO.
- Kroll, D., and K. King, 2007. To switch or not to switch. Potential security considerations in the free chlorine versus monochloramine debate for drinking water disinfection. Proceedings of the ASM Bio-defense and Emerging Diseases Research Meeting, Washington, DC.
- Lytle, J., and E.W. Rice, 2002. A Systematic Comparison of the Electrokinetic Properties of Environmentally Important Microorganisms in Water. *Colloids and Surfaces B: Biointerfaces*, 24, 91-101.
- McKenna, S.A., K.A. Klise, and M.P. Wilson, 2006. Testing water quality change detection algorithms. Proceedings of the 8th Annual Water Distribution Systems Analysis (WDSA) Symposium, Cincinnati, OH.
- O'Halloran, R., R. Jarrett, G. Robinson, and P. Toscas, 2009. Data Processing and Analysis for Online Distribution System Monitoring, AwwaRF, Denver, CO.
- Rice, E. W., N. J. Adcock, M. Sivaganesan, and L. J. Rose, 2005. Inactivation of spores of *Bacillus anthracis* Sterne, *Bacillus cereus*, and *Bacillus thuringiensis* subsp. *israelensis* by chlorination. *Applied and Environmental Microbiology*. 9: 5587-5589.
- Roberson, J.A. and K.M. Morley, 2005, Guidance document, contamination warning systems for water: An approach for providing actionable information to decision-makers, AWWA.
- Sivaganesan, M., N.J. Adcock, and E.W. Rice, 2006. Inactivation of *Bacillus globigii* by chlorination: A Bayesian model. *Journal of Water Supply Research Technology - Aqua*, 55.1: 33-43.
- Szabo, J.G., J.S. Hall, and G.C. Meiners, 2006. Water quality sensor responses to injected contaminants in a chloraminated pipe loop. Proceedings of the AWWA Water Security Congress, Washington, DC.
- Szabo, J.G., J.S. Hall, and G.C. Meiners, 2008a. Sensor responses to contamination in chloraminated drinking water. *Journal of American Water Works Association*, April 2008, Denver, CO.
- Szabo, J.G., J.S. Hall, and G.C. Meiners, 2008b. Detection of biological suspensions using online detectors in a model drinking water distribution system simulator. AWWA Water Security Congress, Cincinnati, OH.
- Umberg, K., N. Mix, B. Pickard, and C. Dangel, 2009. Event Detection System Evaluation, Selection, and Optimization. AWWA Water Security Congress, Washington, DC.



**United States
Environmental Protection
Agency**

Office of Research and Development
National Homeland Security
Research Center
Cincinnati, OH 45268

Official Business
Penalty for Private Use
\$300

EPA/600/R-09/076
October 2009
www.epa.gov

PRESORTED STANDARD
POSTAGE & FEES PAID
EPA
PERMIT No. G-35



Recycled/Recyclable
Printed with vegetable-based ink on
paper that contains a minimum of
50% post-consumer fiber content
processed chlorine free