



**BOILER WATER TREATMENT
FOR KILN DRY OPERATIONS**

**Technical
Presentation**

IMPORTANT TOPICS

- **PRETREATMENT**
- **TEMPERATURE VS OXYGEN**
- **FEED WATER / DA**
- **BOILER WATER**
- **CONDENSATE**

Boiler Water Pretreatment

- **Purpose** - Statistically 75% of all boiler water problems manifested in the boiler have a root cause in the pretreatment system
- **Process** - Walk through the processes, key factors, monitoring, and operational impacts of pretreatment systems
- **Payoff** - Cleaner boilers, increased energy efficiency, reduced maintenance time and costs, increased plant production time and capacity

Pretreatment Methods

- **Lime Softening**
- **Ion Exchange**
Softening & Demineralization
- **Deaeration:**
Full Mechanical & Heaters

Ion Exchange Technology

Ion Exchange

- **Purpose of softening. What is it? Why do we do it?**
- **How softening occurs**
- **The regeneration cycle**
- **Critical factors and troubleshooting**
- **Areas of opportunity and operational enhancement**

Purpose of Softening. What is it? Why do we do it?

- Well and surface water naturally contains calcium and magnesium - referred to as hardness as well as other iron and manganese that are removed in softening.
Examples: Ca, Mg, Fe, Mn, Ba, Al
- These ions adversely impact water and process systems by leading to scaling, corrosion and/or contamination.
- **\$** Removing them improves heat transfer, increases equipment life, and lowers overall operating costs.
- This process is known as Softening.



Hardness can even make a glass of water taste bad!

How Does Ion Exchange Occur?

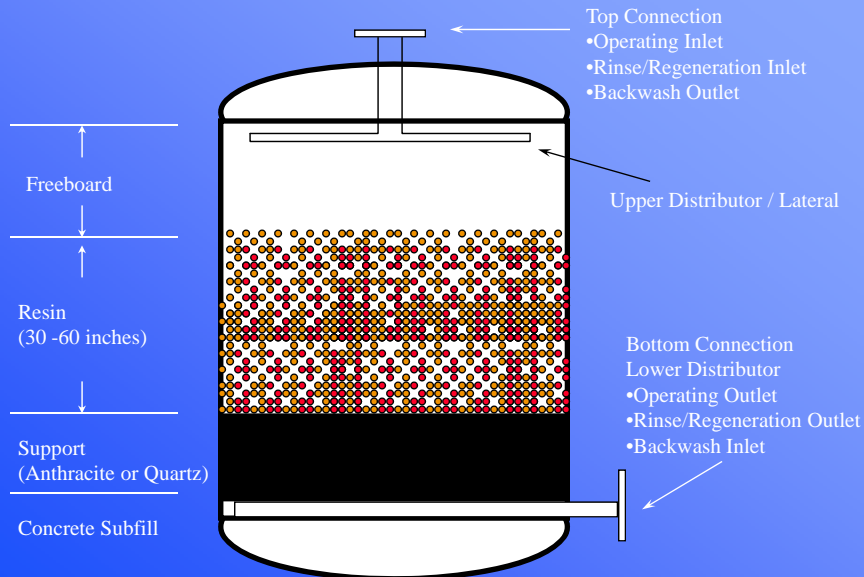

How Does Ion Exchange Occur?

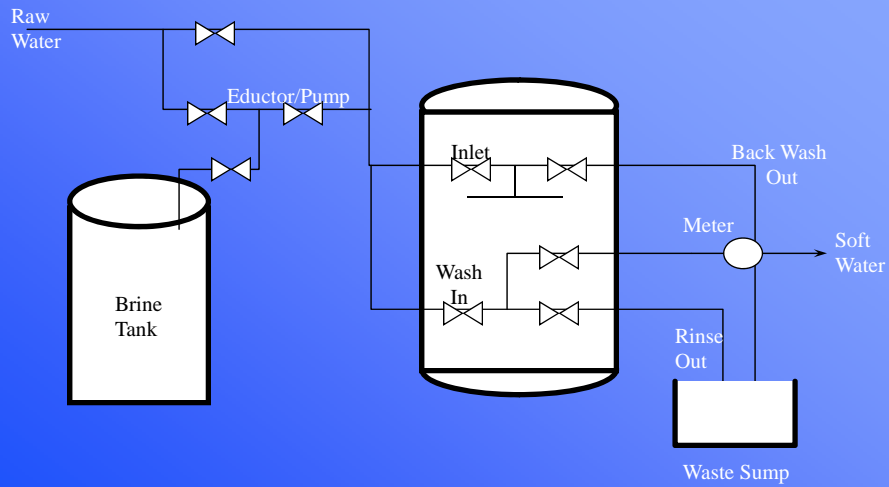

How Does Ion Exchange Occur?

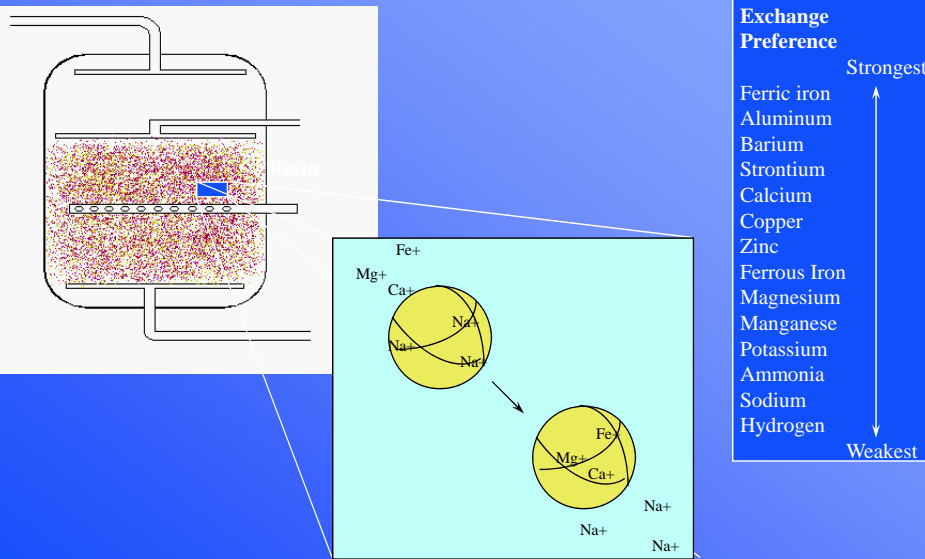

How Does Ion Exchange Occur?

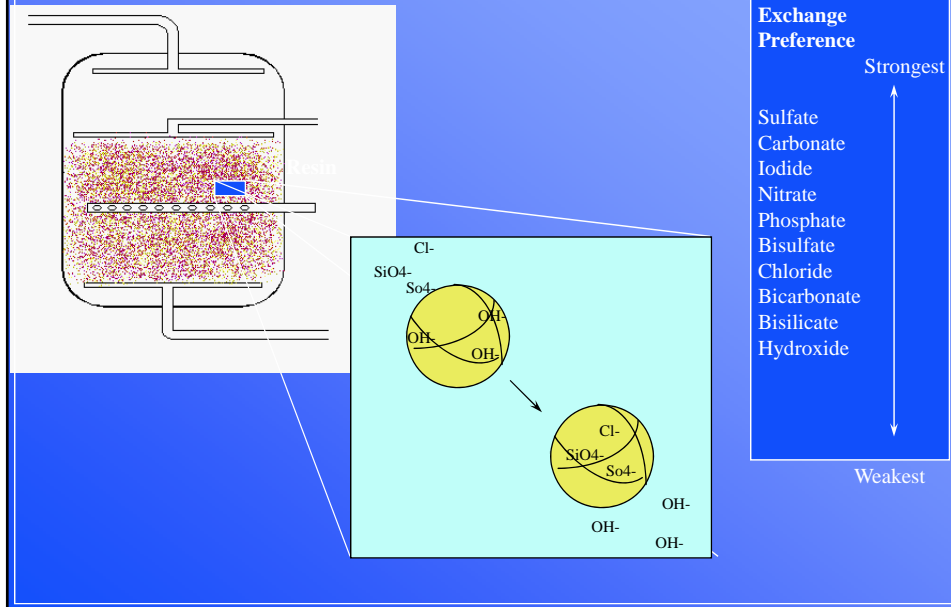

The Regeneration Cycle

- **Resin Exhaustion** When the brine supply on the resin is depleted, the bed is considered “exhausted”. The resin must be replenished by a regeneration process.
- **Regeneration** Regenerating the resin beds is a three step process:
 - 1 - Backwash
 - 2 - Regenerant Addition
 - 3 - Slow Rinse
 - 4 - Fast Rinse

The Regeneration Cycle

- **Backwash** The purpose is to remove suspended solids and redistribute the bed for even flow to prevent channeling.
- **Flow Rate** 50% Bed Expansion for Cation Resin
75% Bed Expansion for Anion Resin
Rates are temperature dependent

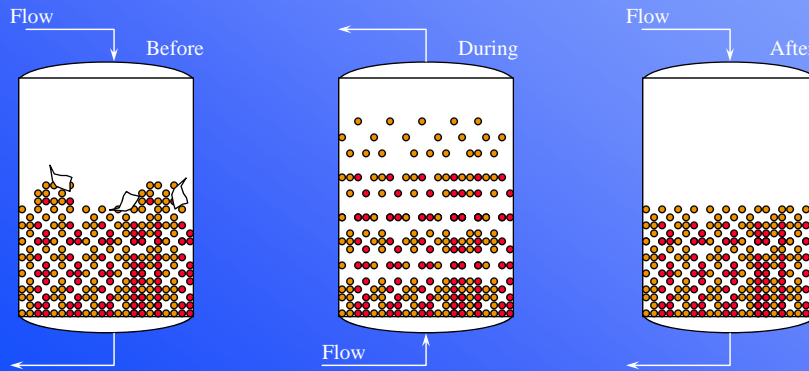

The Regeneration Cycle

- **Regenerant addition / Slow Rinse** The resin is replenished with concentrated Regen. The softening rule is "30/30" (30% brine saturation for 30 minutes in the effluent), @ flow of 1 gpm/ft³, with 15 minutes of draw and 25 minutes of slow rinse.

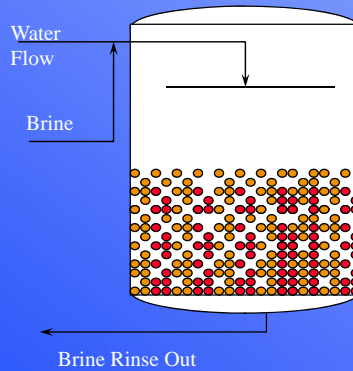

The Regeneration Cycle

- **Fast Rinse** The excess brine left behind during the slow rinse is removed by flushing the resin bed with a high rate volume of water, @ 1.5-2.5 gpm/ft³ for 15 - 30 minutes.

High Volume Water Flow

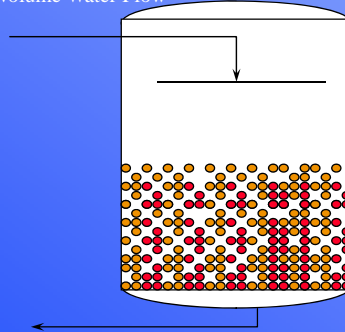

Waste Flush Water

Critical Factors That Affect Run Length Trouble Shooting

- Loss of Resin
- Resin Degradation
- Regeneration Efficiency
- Monitoring Practices

Critical Factors and Trouble Shooting

Loss of Resin During Backwash

- 1 Excessive Backwash Flowrate
- 2 Fluctuating Seasonal Temperatures

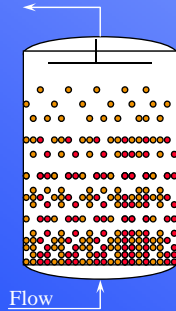

Temperature (°F)	Water Viscosity (cp)	% Bed Expansion
40	1.5	130
50	1.3	100
60	1.1	75
70	1.0	60
80	0.8	50

Flow Rate of 6 gpm/ft²

Evaluating

- Flowrate should be determined by $\text{Flow (gpm)} = [\text{Area (ft}^2\text{)}] [3.46 + 0.072 T(^{\circ}\text{F})]$
- 10-20 minutes backwash under proper flow will redistribute the resin bed.
- Monitor backwash rates seasonally to ensure temperature fluctuations are compensated.
- Measure freeboard annually or use resin traps to ensure resin is not being lost.

Critical Factors and Trouble Shooting

Resin Degradation

There are two degradation that determine resin operating life and throughput capacity:

Fe /Al Fouling

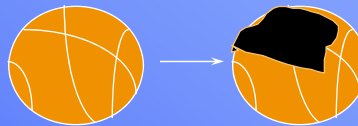

Oxidation Attack

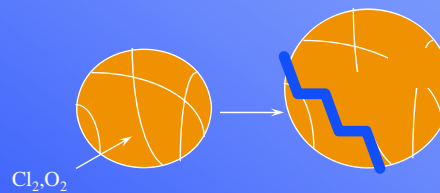

Critical Factors and Trouble Shooting

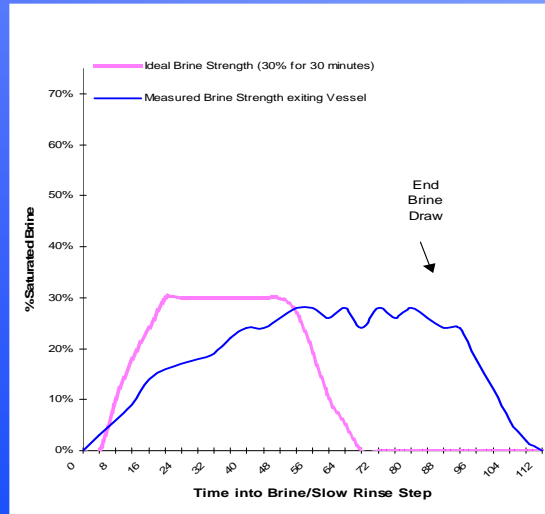

Regeneration Efficiency

- To provide full service run lengths, the resin must be completely regenerated with brine with both the necessary contact time and regenerant concentration.

Critical Factors and Trouble Shooting

MONITORING PRACTICES

Efficient use of regenerant and maximum unit reliability can only be ensured by monitoring the indicators that provide insight into the unit's operating performance.

- **Outlet Hardness - Dependent upon use**
- **Throughput - Each run**
- **Backwash Flow Rate - Semiannually**
- **Backwash Temperature - Summer & Winter**
- **Resin Level - Annually**
- **Resin Integrity - 3-5 years**
- **Regeneration Efficiency - 1 - 2 years**

Critical Factors and Trouble Shooting

Summary / Recap

The factors that affect run length and reliability

- Loss of Resin
- Resin Degradation
- Regeneration Efficiency
- Monitoring Practices

Areas of Opportunity for Operational Enhancement

1. Reduce foulants that decrease run length
 - Filter and/or prevent carry over
 - Fouling treatment
2. Use water unchlorinated or dechlorinated
 - Reduce oxidant attack of resin
2. Monitoring
 - Ensuring the unit's operational performance is being delivered
For Example: Hardness, Run length, etc.
3. Regeneration Monitoring
 - Ensuring the unit is regenerated
 - Preventing excess regenerant use
4. Seasonal temperature monitoring for backwash adjustments
 - Prevent loss of resin through backwash
 - Prevent accumulation of debris and channeling
5. Resin Integrity evaluation
 - Ensuring the resin is not fouled or broken down

Areas of Opportunity for Operational Enhancement

COST IMPACT AREAS

- \$ Reduced Potential for Production of Hard Water
 - Ensures the Prevent of Scaling Operating Equipment
- \$ Reduced Regenerations
 - Reduced Regenerant Costs
- \$ Increased Resin Usage Life
 - Lower Resin Replacement Costs
- \$ Prevent A Production Bottleneck

Deaerators And Oxygen Removal Technology

Discussion

- What Is Deaeration?
- The Process - Removing O₂
- Equipment
- DA Problems
- Operational Impacts
- Monitoring

What Is It?

- Deaeration is the process of removing oxygen and other noncondensable gases from the boiler feed water like Co₂

Removing Oxygen

- Water @ 70°F and Atmospheric Pressure Will Have About 7,000 ppb of O₂
- A Properly Functioning DA Will Reduce the Level to Approximately 5 - 10 ppb
- The Remaining O₂ Is Removed With an Oxygen Scavenger, (i.e. Sulfite etc)

Removing Oxygen

- Three Driving Forces
 - 1- Heat
(Low Pressure Steam, Condensate)
 - 2- Surface Area
(Nozzles, Trays)
 - 3- Pressure
(Vent)

Removing Oxygen

Principle of Surface Area

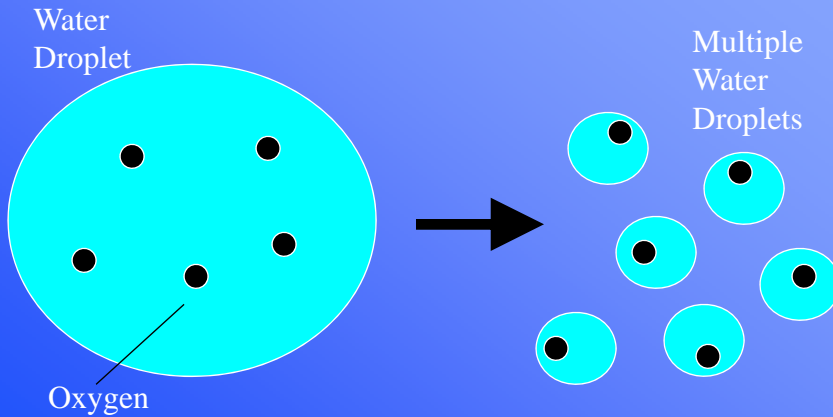

Removing Oxygen

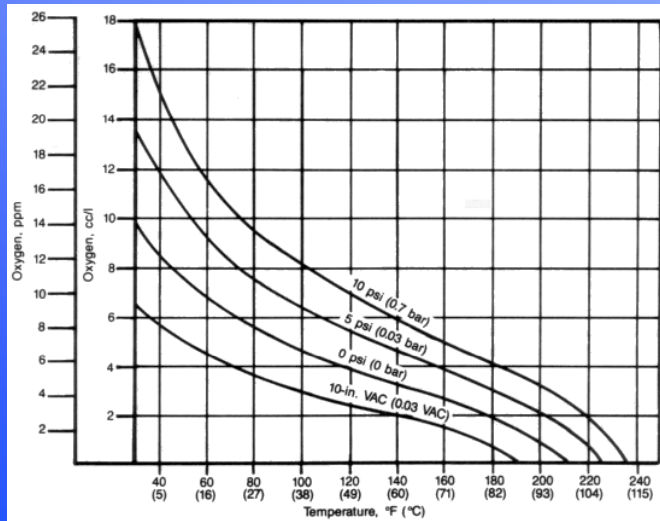

The Corrosion Process

- Anode: $\text{Fe}^0 \rightarrow \text{Fe}^{+2} + 2\text{e}^-$
- Cathode: $2\text{e}^- + \text{H}_2\text{O} + \frac{1}{2}\text{O}_2 \rightarrow 2\text{OH}^-$

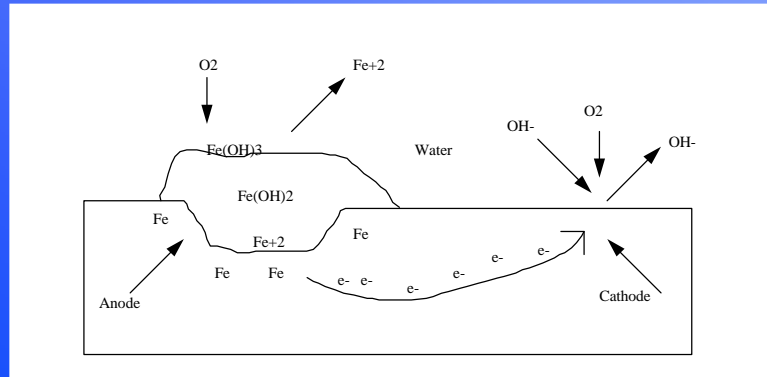

Pitting



Water Flow

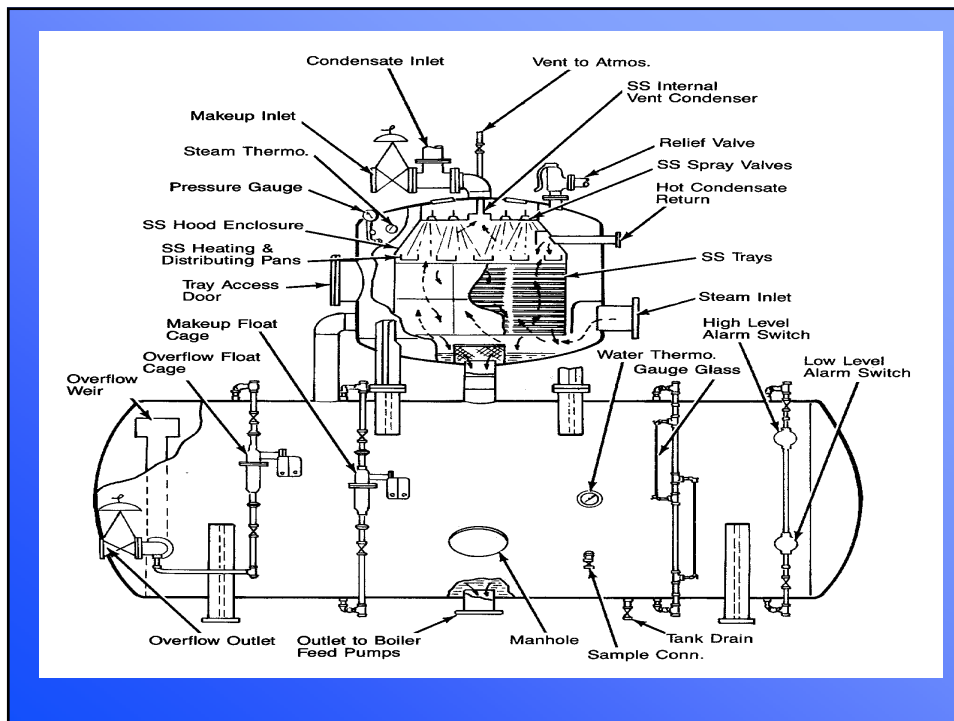
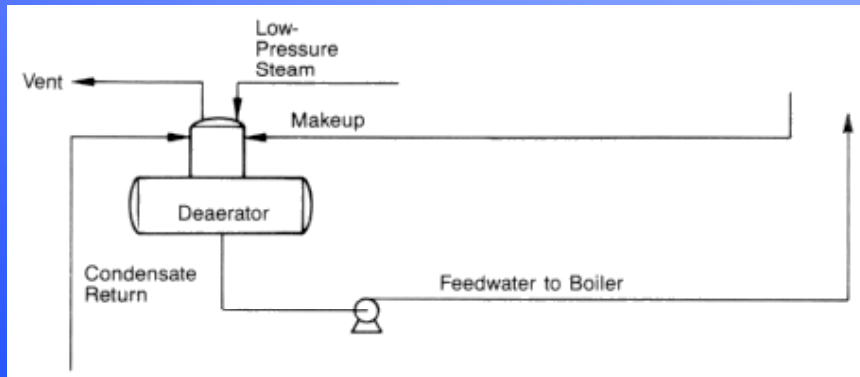

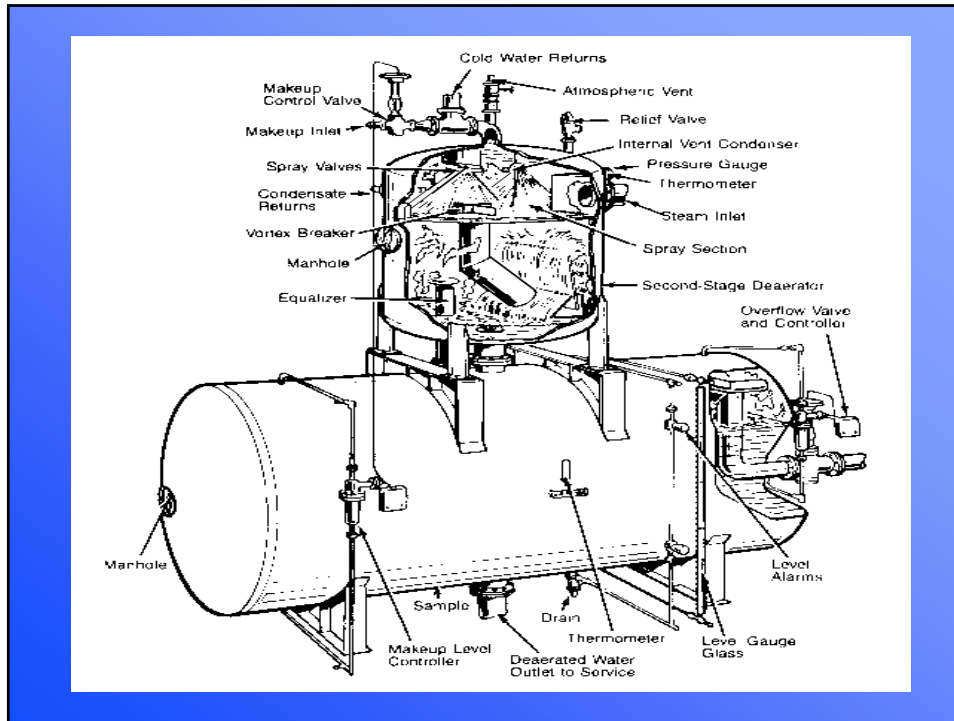

DA Problems

- Inadequate Venting
- Inadequate Steam Flow, Steam Pressure, or Condensate
- Flows Outside of Design Specifications
- Broken, Plugged or Missing Nozzles
- Broken, Plugged or Missing Trays
- Broken or Missing Baffles

Operational Impacts

- Corrosion Potential
- Fe in the Boiler
- Higher Oxygen Scavenger Usage
 - Increased Boiler Conductivity, Lower Cycles
Reduced Boiler Efficiency
 - Greater Chemical Costs
- Reduced DA Life

Monitoring

- Flow
- Temperature
- Pressure
- Scavenger Usage
- Venting
- Inspections

Highlights

- **Maintain 4” Clearness on Vent**
- **Change Nozzles Whether They Need It or Not**
- **Maintain Dome and Storage Within 5°F**
- **Maintain Temperature/Pressure Within 5°F of Saturated Steam**
- **Monitor Scavenger Usage**
- **Clean Trays Annually & Maintain Equipment**

Boiler

- **Boiler Systems:**
 - Boiler Basics
 - ASME Guidelines: Water
 - Chemical Treatment Options
 - Inspection: *What you find tells the story*
 - Steam line treatment

Boiler Types

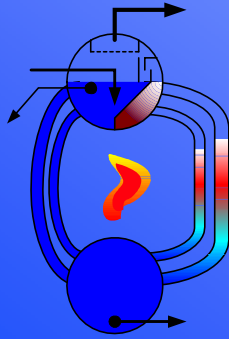

- Firetube
- Watertube
- Electric
- Once Through
- Nuclear Reactor

Boiler Fuels

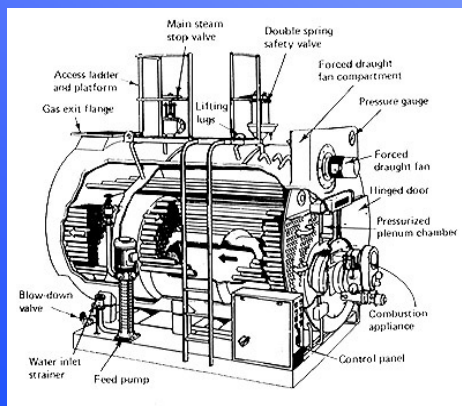

- Wood
- Coal
- Natural Gas
- Waste Heat
 - Furnace Off Gases
 - Incinerators
 - Etc.
- Nuclear

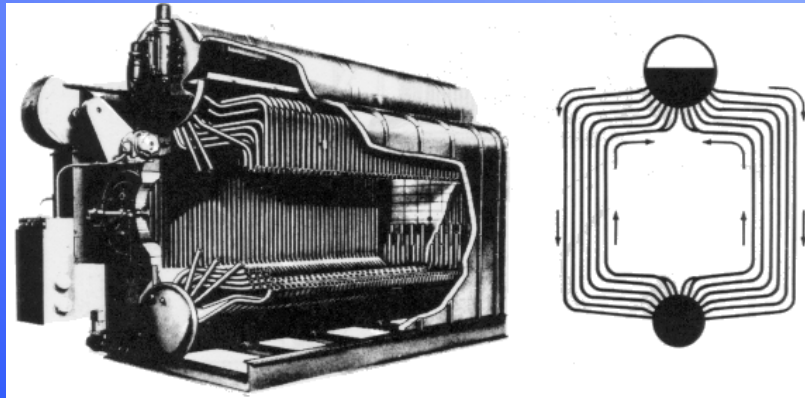

**Typical Package Type Boiler
Watertube**





FIRE TUBE BOILER

ASME Guidelines Industrial Fire tube boilers up to 300psi

Drum Operating Pressure (psig)	0-300
Feedwater	
Dissolved Oxygen before scavenger feed (mg/l O)	<0.04
Dissolved Oxygen after scavenger feed	<0.007
Total iron (mg/l Fe)	<0.1
Total copper (mg/l Cu)	<0.05
Total hardness (mg/l CaCO ₃)	<1.0
Ph range @ 25°F	7.0-10.5
Nonvolatile TOC (mg/l C)	<10
Oily matter (mg/l)	<1
Boiler Water	
Silica (mg/l SiO ₂)	<150
Total Alkalinity (mg/l CaCO ₃)	<700
Free Hydroxide alkalinity (mg/l CaCO ₃)	Not specified
Unneutralized conductivity (µmho/cm @ 25°F)	<7000

ASME Guidelines
Industrial Watertube Boilers up to 900psi
with superheaters & turbine drives

	<300psi	<450psi	<600psi	<750psi	<900psi
Dissolved Oxygen (1)	<7ppb	<7ppb	<7ppb	<7ppb	<7ppb
Total Iron	<.1ppm	<.05ppm	<.03ppm	<.025ppm	<.02ppm
Total Copper	<.05ppm	<.025ppm	<.02ppm	<.02ppm	<.015ppm
Total Hardness	<.3ppm	<.3ppm	<.2ppm	<.2ppm	<.1ppm

Recommended Feedwater Quality

(1) Before Chemical Oxygen Scavenger

ASME Guidelines
Industrial Watertube Boilers up to 900psi
with superheaters & turbine drives

	<300psi	<450psi	<600psi	<750psi	<900psi
Silica	<150ppm	<90ppm	<40ppm	<30ppm	<20ppm
Total Alkalinity (1)	<350ppm	<300ppm	<250ppm	<200ppm	<150ppm
Conductivity (2)	<5400uM	<4600uM	<3800uM	<1500uM	<1200uM

Recommended Boiler Water Quality

Drum Pressure (psig)	Boiler water TDS (ppm TDS)	Boiler water total alkalinity (ppm as CaCO ₃)	Boiler water total suspended solids (ppm TSS)	Steam purity range (ppm TDS)
0-300	700-3500	140-700	15	0.2-1.0
301-450	600-3000	120-600	10	0.2-1.0
451-600	500-2500	100-500	8	0.2-1.0
601-750	200-1000	40-200	3	0.1-0.5
751-900	150-750	30-150	2	0.1-0.5
901-1000	125-625	25-125	1	0.1-0.5
1001-1800	100	Dependent on type of boiler water chemical treatment program	1	0.1
1801-2350	50		None detected	0.1
2351-2600	25			0.05
2601-2900	15			0.05

Types of Programs

- Phosphate
- Phosphate/Polymer
- Chelant/Polymer
- Phosphate/Chelant/Polymer
- All Polymer
- Coordinated pH/Phosphate/Polymer

Phosphate Polymer

Boiler Water Polymers
are Crucial to the
Success of any
Internal Treatment
Programs

Phosphate Treatment Alone Not Optimal

In a phosphate precipitation treatment program, the magnesium portion of the hardness contamination is precipitated preferentially as magnesium silicate. If silica is not present, the magnesium will precipitate as magnesium hydroxide. If insufficient boiler water alkalinity is being maintained, magnesium can combine with phosphate. Magnesium phosphate has a surface charge that can cause it to **adhere to tube surfaces and then collect other solids**. For this reason, alkalinity is an important part of a phosphate precipitation program.

Phosphate/Polymer Treatment Characteristics

- Hardness controlled by precipitation
- Polymers used to control hardness sludge and metal oxides
- Phosphate residual used for program control
- Hydroxide alkalinity required (pH : 10.5 -12)

Boiler Water Polymers

The mechanisms by which boiler water polymers function are

- Complexation / Solubilisation
- Crystal modification
- Dispersion

**Calcium
phosphate,
magnesium
silicate
crystals formed
in
boiler water
without
Dispersant
polymer**

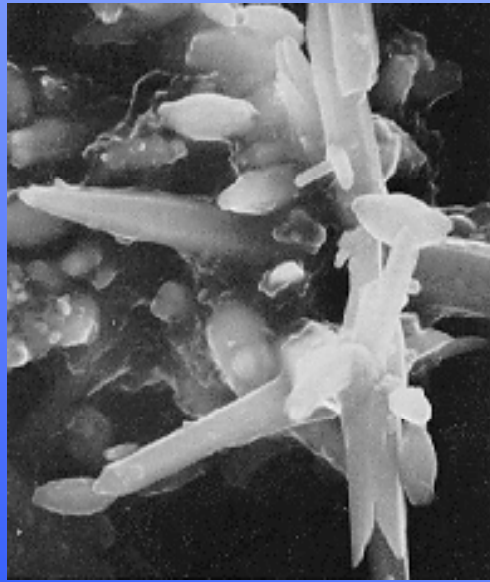

**Calcium
phosphate,
magnesium
silicate
crystals
formed in
boiler water in
the presence of
a sulphonated
polymer**

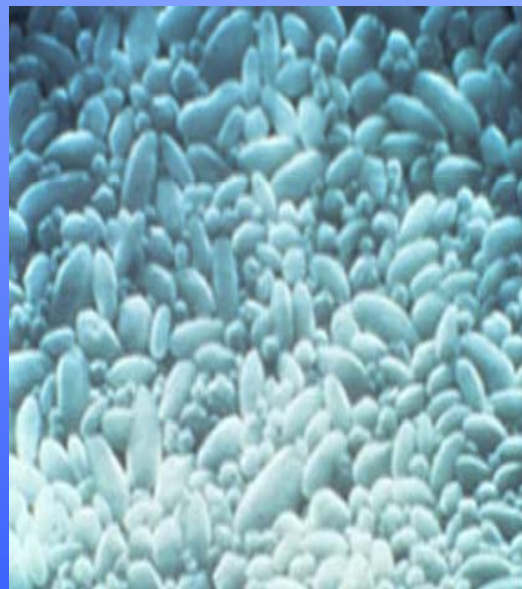

Program Selection Considerations

- Boiler pressure, design
- Pre-treatment plant type
- Feedwater quality
- Hot well, deaerator type
- Steam turbine
- Control capabilities

Phosphate/Polymer Treatment Boiler Control Parameters

- Phosphate residual as PO_4 depending on hardness in the feedwater
- usually associated with boiler pressure
- M alkalinity of 700 ppm as CaCO_3
- Polymer : min 15 ppm as polymer
- Still the most used method for treating low pressure boilers

Phosphate/Polymer

Advantages

- Tolerates a wide range of Feed water hardness
- Non corrosive treatment
- Suitable for low to medium pressure systems
- Easy operator control

Disadvantages

- Is a precipitation program (some deposition is normal)
- Higher blow down rates may be required

Chelant Programs

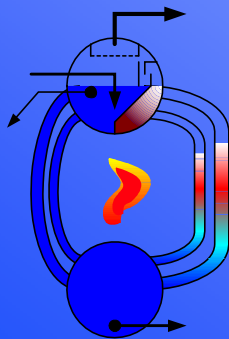

- Require <1ppm BFW Hardness
- Good up to 1000psi
- Clean Program - non precipitating
- Reduced blowdown required
- Chelant corrosion from chemical over-feed

Upset Conditions

What to expect from high BFW hardness

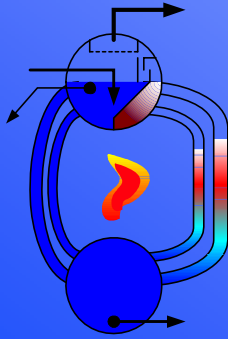

- Chelant Programs
 - Hard scale:
 - Calcium Carbonate

Chelant/Phosphate/Polymer Treatment

Advantages

- Primarily a solubilising treatment
- Effective on hardness and iron
- May allow reduced blowdown
- Increased reliability and efficiency
- Easy and accurate control test
- Tolerates a wide range of feedwater hardness
- Suitable for low to medium pressure systems

Disadvantages

- Some precipitation is possible
- Potentially corrosive if misapplied
- Competing ION

All Polymer Treatment

- Certain polymers can be effective complexing agents
- Principle mechanism is complexation of soluble impurities
- Secondary mechanism is dispersion of particulates
- Fed to the boiler feed water

Boiler Inspection

What you find tells the story

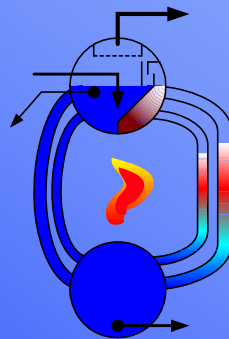

Boiler Scale



What Causes Boiler Scale?

Looking inside the drums

- **Steam drum water line**
 - Erratic indicates high riser velocity \ fireside problem
 - Incorrect height inhibits circulation \ control problem
- **Scale appearance**
 - Uniform and smooth coating is new, patchiness is old
 - Stratified \ intermittent BFW hardness problem
 - Non-stratified \ continuous BFW hardness problem
- **Amount of tube scaling**
 - Wide transition zone indicates circulation problem
 - Riser deposition can indicate too much heat

What Causes Boiler Scale?

Looking inside the firebox

- **Firebox flame pattern**
 - Heavy impingement inhibits circulation \ firing problem
- **Fireside tube slugging**
 - Slugging reduces heat transfer and inhibits circulation
- **Missing Refractory**
 - Can change heat zones and cause circulation problems

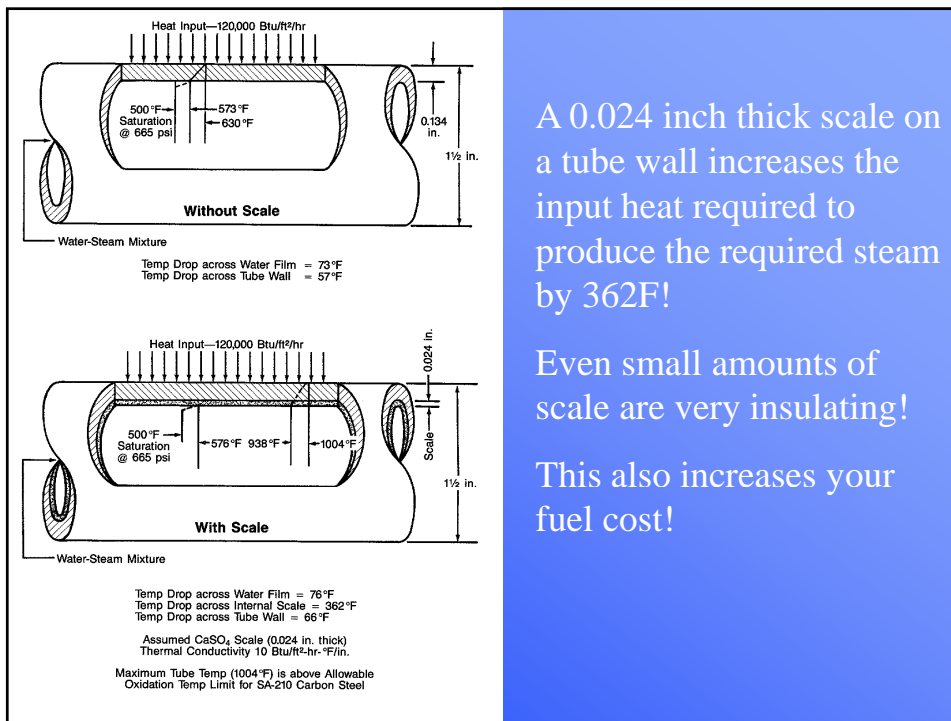

A 0.024 inch thick scale on a tube wall increases the input heat required to produce the required steam by 362F!

Even small amounts of scale are very insulating!

This also increases your fuel cost!

Boiler Deposits



What Causes Boiler Deposit?

- Poor quality boiler feedwater makeup
- Pretreatment system corrosion
- Pretreatment system solids passage
- Condensate system corrosion
- Internal boiler corrosion
- Steam blanketing
- Improper internal treatment control
- Improper Blowdown

Common Deposits in Boilers

Type:

- Silica
- Alumina
- Iron Oxide
- Copper
- Sodium Salts
- High Solids

Typically Caused By:

- Steam blanketing \ Low OH \ High BFW Silica
- Steam blanketing \ BFW Alumina
- BFW iron \ Condensate Corrosion \ Preboiler corrosion
- BFW copper \ Condensate Corrosion \ Preboiler corrosion
- Evaporation to dryness
- Improper control of TDS

Boiler Corrosion

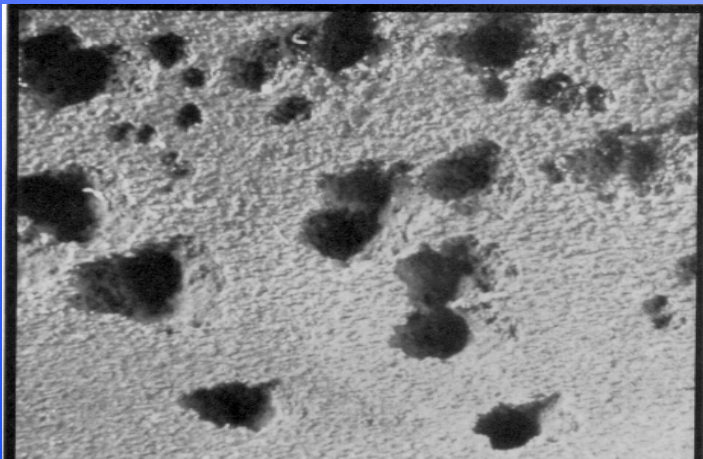

Corrosion Types in Boilers

Type:

- Oxygen attack
- Alkalinity concentration
- Acid attack
- Chelant \ Polymer attack
- Ammonia attack

Typically Caused By:

- BFW Oxygen
- Concentration of caustic under deposits
- Acid leaks into BFW or condensate
- Excessive chemical concentration
- High ammonia returned in condensate or from BFW

Neutralizing Amines

- Neutralize carbonic acid
- Do not protect against oxygen corrosion
- Maintain condensate pH 8.5-9.0
- Add in direct proportion to amount of CO₂ in steam
- Most products are blends of two or more neutralizing amines
- Important operational considerations are volatility, acid neutralization ability, and basicity

Neutralizing Amines

Basicity - a measure of amine's ability to raise pH in condensate

Enough amine must be added to neutralize all carbonic acid

Additional amine then added to maintain pH

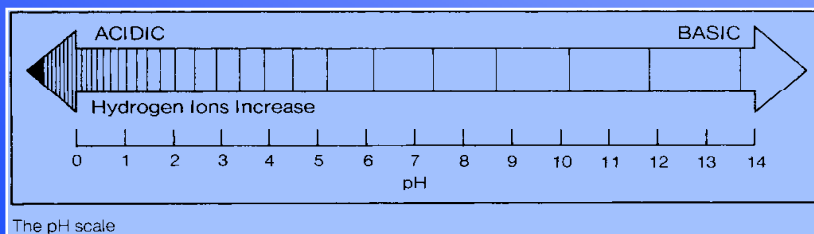

Steam Line Treatment

The four most common neutralizing amines (or amine blends) are ammonia, AMP, cyclohexylamine, diethylaminoethanol, and morpholine. Neutralizing amines are fed to maintain a pH of 8.2 to 8.6; however, in difficult to control systems a wider pH value of 7.6 to 8.6 may have to be used.

Ammonia

Ammonia is used in steam lines where the steam contains a large amount of carbon dioxide or where there is an appreciable amount of steam loss from the condensate system. The advantage of ammonia is that the relative cost is less than other amines. The disadvantage is that it cannot be used in systems containing copper or nickel.

Cyclohexylamine

Cyclohexylamine has been used primarily for low pressure systems (50 down to 5 psi) and also for systems with long condensate runs. This amine has a lower solubility ratio and may cause plugging in the steam line.

Diethylaminoethanol

Diethylaminoethanol also called DEAE is versatile in that the distribution ratio is between that of cyclohexylamine and morpholine making it a very good medium run amine, effective in many industrial condensate systems. The disadvantage is that DEAE is not very effective in low pressure systems.

Morpholine

Morpholine has a low distribution ratio and is commonly blended with other amines. The short distribution ratio makes morpholine effective on short run systems and also for the protection of steam turbines.

Blow down controllers are used to manage total dissolved solids during load swings and can be useful in Kiln Dry Operations



Driving a turbine with wet steam





Clarity Water Technologies, LLC
P.O. Box 1229
Twinsp of Washington, NJ 07676

Thomas Hageman Partner/Dir of Product Development
Durgin Rd
Chichester, NH 03258
603-568-5653

