

Introduction to Operation and Maintenance of Water Distribution Systems



JE van Zyl



**Introduction to
Operation and Maintenance
of Water Distribution Systems**

EDITION 1

JE VAN ZYL



**WATER
RESEARCH
COMMISSION
TT 600/14**

Obtainable from:

Water Research Commission

Private Bag X03

Gezina, 0031

orders@wrc.org.za

The publication of this report emanates from a project entitled *Practical Guidelines for Operation and Maintenance of Water Distribution Systems in South Africa* (WRC Project No. K5/2135)

Disclaimer

This report has been reviewed by the Water Research Commission (WRC) and approved for publication. Approval does not signify that the contents necessarily reflect the views and policies of the WRC, nor does mention of trade names or commercial products constitute endorsement or recommendation for use.

ISBN 978-1-4312-0556-1

Printed in the Republic of South Africa

July 2014

Designer: Jacob Krynanuw

Cover design and illustration: Jacob Krynanuw

jacobkrynanuw@gmail.com

This book is dedicated those dedicated men and women who operate and maintain our water distribution systems.

Acknowledgments

This guide book emanated from a project initiated and funded by the Water Research Commission as Project K5/2135:

Practical guidelines for operation and maintenance of water distribution systems in South Africa.

Particular credit and thanks are due to Mr Jay Bhagwan of the Water Research Commission, who initiated the project and chaired the Reference Group. I would also like to acknowledge the other members of the Reference Group and thank them for their time and guidance: Mr Keith Bailey (Elster Kent), Mr Basil Bold (Sensus), Mr Eddie Delpont (Breede Valley Municipality), Mr. Mpfafane Deyi (University of Cape Town), Prof Heinz Jacobs (University of Stellenbosch), Mr Grant Mackintosh (Emanti), Mr B Martin (Nelson Mandela Metropolitan Municipality), Mr Johan Mettler (Drakenstein Municipality), Mr Speedy Moodlior (Ethekewini Water and Sanitation), Mr Ntshavheni Mukwevho (Johannesburg Water), Mr Mike Rabe (Re-Solve) Mr Simon Scruton (eThekwini Water and Sanitation), Mr Kobus Streuders (Department of Water Affairs), Prof Fanie van Vuuren (University of Pretoria), Dr Kevin Wall (CSIR) and Mr Trevor Westman (City of Tshwane). A special thanks to Mrs Charmaine Khanyile (WRC) who coordinated the project meetings and administration and Mr Steven Sims, who helped with proofreading.

The book would not have had much practical value was it not for the input by numerous individuals who took part in workshops and site visits, or sent me their comments after reading drafts of the book. Thank you for the time and advice so generously given. I would like to particularly acknowledge the contributions of Mr Pravesh Boodhoo (Umgeni Water), Mr Graham Chapman (Ethekewini Water and Sanitation), Mr Mustafa Clarke (Kai !Garib Municipality), Mr Gregory Johnston (Ethekewini Water and Sanitation), Ms Melissa de Sousa-Alves (City of Cape Town), Mr Mpfafane Deyi (University of Cape Town), Mr David Drummond (Ethekewini Water and Sanitation), Mr Richard Edson (Overberg Water), Mr Johannes Fielies (Eskom), Mr Mervin Govender (Ethekewini Water and Sanitation),

Mr Hein Henning (Drakenstein Municipality), Mr André Kowalewski (Drakenstein Municipality), Johan Malan (Breede Valley Municipality), Mr Pierre Maritz (City of Cape Town), Mr Jabulani Mayise (Ethekewini Water and Sanitation), Mr Mawande Mbane (Ethekewini Water and Sanitation), Ms Eva Muinamia (Stabilis Development), Mr Sifiso Nkonyane (Drakenstein Municipality), Mr Alf Moll (City of Cape Town), Ms Mirriam Olifant (Johannesburg Water), Mr Vishal Poona (Joat Consulting), Mr John Potgieter (City of Cape Town), Mr Graham Reid (City of Cape Town), Ms Bhawna Soni (Ethekewini Water and Sanitation) and Mr Hennie van Staden (AECOM).

I would like to acknowledge and thank Mr Jacob Krynauw (Jacob Krynauw Creative Design Solutions) for the inspired front cover and excellent book layout and graphics. Thanks to the many individuals and organisations not mentioned who contributed in various ways to this book, and the University of Cape Town for administrative support.

Finally, I would like to thank my wife Hanlie and children Jean and Ankia for their unwavering love and encouragement throughout the writing of this book.

Photograph credits

I would like to acknowledge the following individuals and institutions who contributed photographs used in this book:

- City of Cape Town (Mr Alf Moll)
- eThekewini Water and Sanitation (Mr Mervin Govender and Mr Graham Chapman)
- DPI Plastics (Mr Renier Snyman)
- Marley Pipe Systems (Mr Ian Venter)
- Tasha Govender of the University of Cape Town

TABLE OF CONTENTS

Acknowledgments	iv
Chapter 1: Introduction	1
1.1 Why this Book?	1
1.2 Complexity of the problem	2
1.3 What is operation and maintenance?	3
1.4 System Integrity	4
1.5 Important notes	5
1.6 About this book	5
1.6.1 Who should read this book?	5
1.6.2 How are the chapters organised?	6
1.6.3 A few tips for getting more out of this book	7
Chapter 2: Physical Integrity	11
2.1 Introduction	11
2.2 Consequences of loss of physical integrity	12
2.3 Causes of a loss of physical integrity	12
2.3.1 Design and construction factors	13
2.3.2 Physical Factors	13
2.3.3 Chemical Factors	14
2.3.3.1 Corrosion	14
2.3.3.2 Permeation	16
2.4 Measuring physical integrity	16
2.5 Maintaining physical integrity	17
2.5.1 Design and construction	17
2.5.1.1 Design	17
2.5.1.2 Materials selection	18

2.5.1.3 Workmanship and quality control	18
2.5.2 Operation	18
2.5.3 Maintenance	19
2.6 Common materials used in distribution systems	20
2.6.1 Asbestos cement	20
2.6.2 Bitumen	20
2.6.3 Cement and concrete	20
2.6.4 Copper and Brass	21
2.6.5 Iron and Steel	22
2.6.6 Polyethylene	22
2.6.7 PVC	23
2.6.8 Rubber	23
2.6.9 Glass reinforced plastic (GRP)	23
2.6.10 Other materials	23
Chapter 3: Hydraulic Integrity	25
3.1 Introduction	25
3.2 Consequences of a loss of hydraulic integrity	26
3.3 Causes of a loss of hydraulic integrity	26
3.3.1 Excessive demands	28
3.3.2 Reduction in system capacity	29
3.3.3 Negative pressures	29
3.3.4 Pumping directly from the network	29
3.3.5 Pressure transients	30
3.3.6 Excessive pressures	30
3.3.7 Low velocities	30
3.3.8 Wrong operational settings	31
3.3.9 Air in the system	31
3.4 Measuring and modelling hydraulic integrity	31
3.5 Maintaining hydraulic integrity	32
3.5.1 Design and Construction	32
3.5.2 Operation	33
3.5.3 Maintenance	34
Chapter 4: Water Quality Integrity	35
4.1 Introduction	35

4.2 Properties of water	36
4.2.1 Physical properties	36
4.2.2 Chemical properties	38
4.2.2.1 Inorganic chemicals	38
4.2.2.2 Organic substances	38
4.2.3 Microbiological properties	39
4.3 Consequences of a loss in water quality integrity	40
4.4 Causes of a loss of water quality integrity	41
4.4.1 Contamination from external sources	41
4.4.2 Internal deterioration of water quality	42
4.5 Measuring water quality integrity	43
4.6 Maintaining water quality integrity	43
4.6.1 Design and Construction	44
4.6.2 Operation	44
4.6.3 Maintenance	46
Chapter 5: Systems for Managing Operation and Maintenance	47
5.1 Introduction	47
5.2 Water balance^r	47
5.2.1 Real losses	48
5.2.2 Benchmarking system leakage	50
5.3 Asset management	50
5.3.1 Introduction	50
5.3.2 Technical assessment	54
5.3.3 Financial assessment	54
5.3.4 Asset management practices ^b	55
5.4 Water safety plan^x	56
Chapter 6: Pipes	59
6.1 Introduction	59
6.2 Joint types	59
6.3 Pipe materials	61
6.4 Deterioration and common failure patterns	64

6.5 Operation and maintenance of pipes	65
6.5.1 Design and Construction	65
6.5.2 Operation	67
6.5.3 Maintenance	67
6.6 Common operation and maintenance tasks	69
6.6.1 Locating pipes	69
6.6.2 Locating leaks	69
6.6.3 Repairing leaking pipes	70
6.6.4 Trenchless rehabilitation and replacement of pipes ^v	71
6.6.5 Disinfection	74
Chapter 7: Pipe Fittings and Accessories	77
7.1 Introduction	77
7.2 Valves	77
7.2.1 Isolation valves	78
7.2.2 Air valves	79
7.2.3 Scour valves	81
7.2.4 Non-return valves	81
7.2.5 Control valves	81
7.3 Fire hydrants	82
7.4 Water meters	84
7.5 Chambers	87
7.6 Markers	87
7.7 Thrust blocks	88
Chapter 8: Reservoirs and Water Towers	91
8.1 Introduction	91
8.2 Reservoirs and water towers	91
8.3 Deterioration and common failure patterns	92
8.4 Operation and maintenance of reservoirs and water towers	93
8.4.1 Design and construction	93
8.4.1.1 Reservoir sizing	93
8.4.1.2 Structure	93

8.4.1.3 Pipe work	94
8.4.1.4 Other	95
8.4.2 Operation	95
8.4.3 Maintenance	96
8.5 Common operation and maintenance tasks	97
8.5.1 Reservoir cleaning ^d	97
8.5.2 Disinfection	97
Chapter 9: Pumps	99
9.1 Introduction	99
9.2 Pumps	99
9.2.1 Introduction	99
9.2.2 Characteristic curves of a centrifugal pump	99
9.2.2.1 Head-flow curve	100
9.2.2.2 Efficiency curve	100
9.2.2.3 NPSH curve	101
9.2.3 System curve	101
9.2.4 Duty point	102
9.2.5 Pump selection	102
9.2.6 Pump drivers ^d	104
9.2.7 Pump energy cost	104
9.3 Operation and maintenance of pumps	105
9.3.1 Design and construction	105
9.3.2 Operation	106
9.3.3 Maintenance	107
9.4 Common operation and maintenance tasks	108
9.4.1 Checking pump operation	108
9.4.2 Common pump problems	108
9.4.3 Common motor problems	114
Chapter 10: Water Distribution Systems	121
10.1 Introduction	121
10.2 Water distribution networks	121
10.2.1 Introduction	121
10.2.2 Network hydraulics	121
10.2.3 Hydraulic network models	122

10.2.4 Flow measurement	123
10.2.5 Pressure measurement	123
10.3 Operation and maintenance of water distribution systems	124
10.3.1 Design requirements	124
10.3.2 Operation	126
10.3.3 Maintenance	128
10.4 Common operational tasks	128
10.4.1 District metered areas (DMAs)	128
10.4.2 Pressure management	128
10.4.3 Dealing with low pressure problems ^s	129
10.4.4 Optimal pump scheduling ^s	130
References	133
Appendix A: Organisations	135
Appendix B: Forms	136

INTRODUCTION



1.1 Why this Book?

A reliable supply of clean and safe water is the first and most critical municipal service that people require. Developing countries like South Africa have made great strides in addressing the inequalities of the past in the provision of water, but unfortunately the focus on expanding service provision has often been at the expense of adequate operation and maintenance of existing infrastructure. This has resulted in increased levels of leakage and non-revenue water, maintenance backlogs and problems with service provision.

Proper operation and maintenance are indispensable to ensure that capital investments on new infrastructure result in sustainable service provision. Without it, a new water distribution system will soon decline to a point where service provision is compromised, leading to greater water losses, financial losses and health risks to consumers. If operation and maintenance are neglected for long enough, it may become necessary to replace the system, requiring a new injection capital that could otherwise be used for other needs or stimulating economic development.

The aim of this book is to assist service delivery by making information on proper operation and maintenance practices available in a practical and accessible way. The book focuses on water distribution systems including pipes, pumps, valves, storage reservoirs, meters and other fittings. It does not deal with other equally important elements of the water supply chain such as the protection of water sources, raw water systems, water treatment plants and plumbing systems. In addition, the book focuses on technical issues of operation and maintenance, and does not deal with associated factors such as human resources management, data systems, funding, and public participation and accountability.

The approach adopted in the book is to provide the reader with an understanding the processes leading to system decline, measuring system performance and the best practices in operation and maintenance of water distribution systems. It aims to provide guidance to empower the reader to implement a proper operation and maintenance system in practice, focussing on the most common and important aspects.

Selected documents with detailed operation and maintenance guidance on specific aspects of water distribution systems are listed at the end of each chapter.

1.2 Complexity of the problem

Operation and maintenance of water distribution systems are done in a very complex environment with numerous (and often conflicting) services to deliver, influencing factors, legislative requirements and stakeholder relationships. Factors making municipal service provision a challenging task are shown in Figure 1. Note that this book covers just two aspects (operation and maintenance) of a single component (the distribution system) of one of the municipal services (water supply) that municipalities are responsible for.

- **Technology changes** affect the way that services are provided and managed, particularly in information technology where hardware and software are constantly developing.
- **Diverse stakeholders** (national and provincial departments, local councils, the public, consultants, suppliers and contractors) need to be engaged with through various means (public participation, job creation, environmental protection, financial management, etc.).
- A large range of **legislation** that needs to be complied with in diverse fields including service provision, technical standards, equity, environmental protection, procurement, health and safety and financial management.

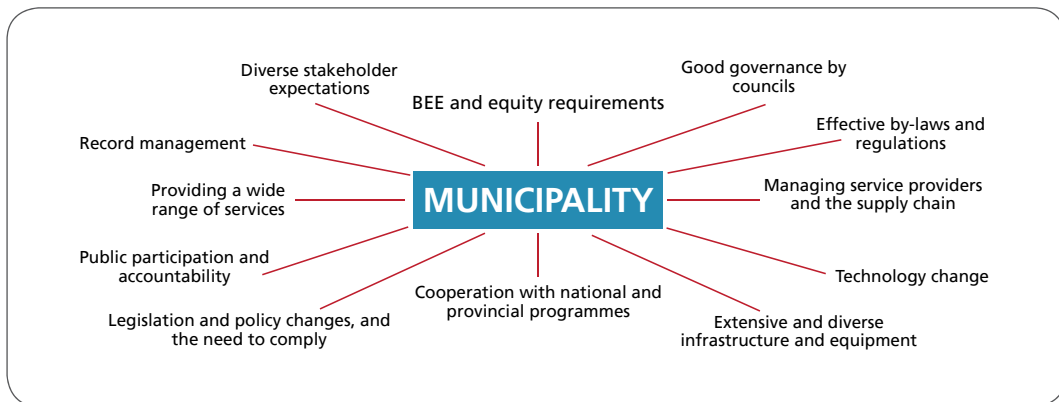

Figure 1 The numerous challenges facing municipalities in providing services^d

It is worth noting some of the factors adding to the complexity of operating and maintaining water distribution systems^d:

- A **wide range of services** needs to be provided by municipalities, often to a growing and diverse population.

In addition, most municipalities are struggling with three critical deficiencies: old and deteriorating infrastructure, a lack of resources and a lack of capacity^d (including properly trained personnel and institutional knowledge). The lack of resources and capacity often forces municipalities to focus

on the most critical problems and neglect crucial operation and maintenance functions that have longer-term impacts. This, in turn, leads to further deterioration of infrastructure and a downward spiral of escalating inefficiency.

The Department of Water Affairs state this clearly in the terms of reference for the National Water Services Infrastructure Asset Management Strategy ⁸:

Money “saved” on maintenance of assets is never a saving. This is a short-term outlook, often said to be due to political short-term imperatives and lack of capacity and know-how within the municipality. It can become a vicious cycle once infrastructure is allowed to deteriorate. Expensive refurbishment becomes necessary and there is even less money for on going maintenance. In addition, deteriorating infrastructure leads to poor service delivery and reduced payment by consumers, exacerbating lack of cost recovery. Government is facing a looming crisis unless something is done.

1.3 What is operation and maintenance?

The purpose of a water distribution system is to provide an adequate and reliable supply of safe water to its users. Operation and maintenance are those activities needed to continuously fulfil this purpose.

The difference between operation and maintenance is that operation involves

The purpose of a water distribution system is to provide an adequate and reliable supply of safe water to its users. Operation and maintenance are those activities needed to continuously fulfil this purpose.

activities necessary to deliver the service, while maintenance involves activities that keep the system in good operating condition ^d.

The difference between operation and maintenance is that operation involves activities necessary to deliver the service, while maintenance involve activities that keep the system in good operating condition.

Operation includes monitoring the system state, running the system and enforcing policies and procedures. Maintenance entails condition assessment, servicing, repair and replacement of system components. When maintenance is done before a system element fails in order to prevent it from failing, this is called proactive maintenance. Maintenance done after a component failure is called reactive maintenance.

Operation and maintenance of a water distribution system can be greatly affected by the system design and construction practices used. For instance, a design that specifies unsuitable pipe materials or pipes that are damaged during construction may lead to major future operation and maintenance problems for the system.

Cost is a major factor in the provision of municipal services and thus it is important that operation and maintenance is done in such a way that the required level of service is provided at the minimum cost over the long term. It is often possible to save major costs in the future by using higher quality components or performing preventative maintenance, even though it will be cheaper not to do this in the short term. For instance, installing a cathodic protection

system on a steel pipe can ensure that the service life of the pipe is greatly extended, saving the much greater cost of replacing the pipeline.

1.4 System Integrity

System integrity is defined as the state that a water distribution system has to be in to ensure that it fulfils its purpose. Three types of integrity can be identified ⁶:

- **Physical integrity** means that the system components are able to function as intended and provide a barrier

between the water in the system and external threats.

- **Hydraulic integrity** means that the system is able to provide the flows and pressures required for the required level of service.
- **Water quality integrity** means that the system is able to deliver water of acceptable quality to all its users (assuming that it receives source water of acceptable quality).

The different types of system integrity are not independent, but influence each other as shown in Figure 2. For instance, a loss

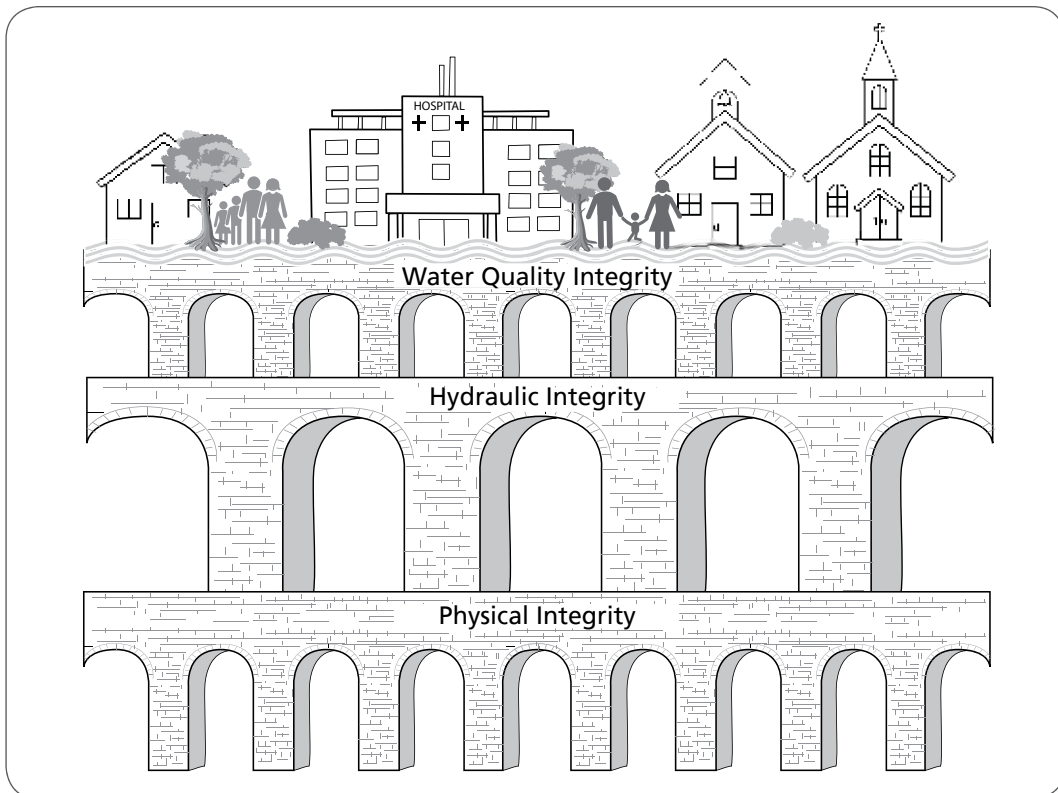

Figure 2 Physical, hydraulic and water quality integrity are essential for providing adequate and safe water to the public.

of physical integrity due to cracks in pipes may lead to a loss of hydraulic integrity through increased friction losses, and a loss of water quality integrity if polluted water outside the network is able to enter the pipes through the cracks.

Ideally, there should be no change in water quality from the time it leaves the treatment plant until its delivered to the consumer, but in reality substantial changes may occur as a result of complex physical, chemical, and biological reactions ^f.

The fact that the public depends on water distribution systems for drinking water places an important responsibility on the shoulders of the municipality and its employees. Consider how people carefully clean dishes and kitchen surfaces that come into contact with food. The public trusts water from the tap, and by extension the water distribution system, to comply with the same levels of hygiene. It is possible to think of the distribution system as a large and complex ‘kitchen bowl’ holding public drinking and cooking water.

Developing countries are not able to spend the same resources as developed countries on the operation and maintenance of water distribution systems. Conversely, consumers in developing countries are more dependent on a safe municipal water supply since they cannot afford bottled water or home treatment systems, and are more vulnerable to the effects of water-borne disease due to lower levels of nutrition, lack of adequate health care systems and the burden of immuno-compromising diseases such as HIV/AIDS.

1.5 Important notes

A number of important points should be kept in mind throughout the reading and use of this book:

- The **health and safety** of the public and employees are of highest importance and appropriate measures should always be taken to protect health and safety.
- It is not possible to cover all possible water distribution system components in a single book, and thus only the most important requirements are discussed in a generic way. It is always important to carefully **follow the manufacturer’s operation and maintenance requirements** of any specific component used in a water distribution system.
- Operation and maintenance functions require **competent and well-trained staff**, and this should be ensured in all cases.
- Each distribution system is unique and **knowledge and experience of local conditions and problems** are essential. It is always advisable to implement changes in system operations carefully and to use pilot studies to test these technologies whenever possible.

1.6 About this book

1.6.1 Who should read this book?

The book is primarily aimed at managers and staff who deal with the operation and maintenance of water distribution systems. The book does not require the reader to

have much technical background or prior knowledge of water distribution systems, although such knowledge will undoubtedly help with understanding the concepts covered. The book should also be useful to bulk water suppliers, government agencies, consultants and NGOs dealing with water supply.

1.6.2 How are the chapters organised?

This book is organised into two parts as illustrated in Figure 3:

Part 1: Introduction and basics. The objectives and approach of the book are explained in Chapter 1, followed by three chapters dealing with the basics of water distribution system integrity that motivate operation and maintenance actions. The final chapter of this part of the book deals with basic systems important for managing operation and maintenance in water distribution systems. Thus Part 1 consist of five chapters:

- Chapter 1: Introduction
- Chapter 2: Physical integrity

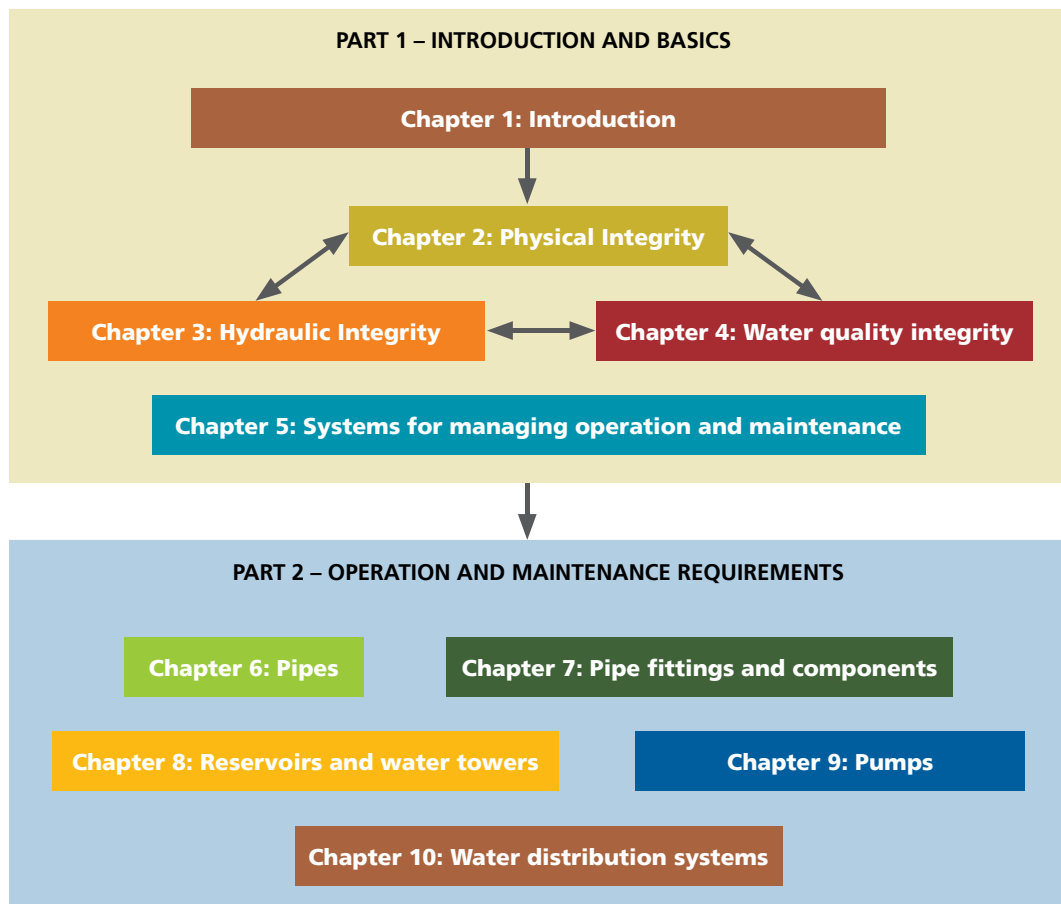

Figure 3 Layout of the chapters of this book

- Chapter 3: Hydraulic integrity
- Chapter 4: Water quality integrity
- Chapter 5: Systems for managing operation and maintenance

Part 2: Operation and maintenance requirements. In this section, the operation and maintenance requirements of specific network components are discussed. Part 2 consists of five chapters:

- Chapter 6: Pipes
- Chapter 7: Pipe fittings and components
- Chapter 8: Reservoirs and water towers
- Chapter 9: Pumps
- Chapter 10: Water distribution systems
- Reference material. At the end of the book a reference section provides a list of additional sources of information and resources.

1.6.3 A few tips for getting more out of this book

The illustrations, photographs and diagrams used in the book were carefully selected to assist with understanding the concepts covered. Two types of text boxes are used in the text to highlight important points made in the book, and to provide examples or case studies:

Text box highlighting important information

Text box giving an example or case study

Additional Reading

Operation and maintenance of water distribution systems

- The Operation and Maintenance Project of the Northern Cape, a partnership between several national and international bodies, produced the Water Supply Services O&M Handbook, a comprehensive and practical set of documents that can be of great use to municipalities in South Africa and other countries. It consists of a number of booklets:
 - i. Water resources in the Northern Cape
 - ii. Management services
 - iii. Management of drinking water quality
 - iv. O&M of intakes from rivers, canals and dams
 - v. O&M of groundwater supply
 - vi. O&M of pumps, drives and pump stations
 - vii. An introduction to water and water treatment
 - viii. O&M of treatment infrastructure and processes
 - ix. O&M of package and desalination treatment plants
 - x. O&M of reservoirs
 - xi. O&M of water supply networks and fittings
 - xii. Remote monitoring and control systems.
 - xiii. Water demand management
- Another useful set of documents produced by the Operation and Maintenance Project of the Northern Cape deals with wider management aspects and is called the Handbook on Management and O&M. It consists of the following booklets:
 - i. Management of services and O&M
 - ii. Asset management and O&M
 - iii. Communication, information and participation
 - iv. Planning O&M and performance management
 - v. Human resources management
 - vi. Enhancing individual and team performance
 - vii. Enhancing personal and organisational performance
 - viii. Project management
 - ix. Financial Management
 - x. Management of the supply chain and service providers
 - xi. Management of office, stores and workshops
 - xii. Records management

These documents may be obtained from Mr Kobus Streuders, Department of Water Affairs (Northern Cape), Private Bag X6101, Kimberley, 8300, Ph. 053 830 8800, Email streudersk@dwa.gov.za.

These documents may be obtained from Mr Kobus Streuders, Department of Water Affairs (Northern Cape), Private Bag X6101, Kimberley, 8300, Ph. 053 830 8800, Email streudersk@dwa.gov.za.

Legislation applicable to water distribution systems

- Review of Regulatory Aspects of Water Services Sector by Daniel Malzbender, Anton Earle, Hameda Deedat, Brian Hollingworth, Palesa Mokorosi. WRC Report TT 417/09.
- An article on the relevance of the Consumer Protection Act to municipal services by Sarah Slobber presented at the 2010 IMESA conference: Slabbert, S (2010) "What are your rights? Legal aspects of municipal services from the perspective of the domestic consumer." Download from <http://www.imesa.org.za/images/conf2010papers/3.pdf>.

Legislation related to the management of water distribution system infrastructure 9:

- Municipal Systems Act (Act 32 of 2000) which sets out rights, duties, authority and core processes, and, among other things, requires municipalities to prepare integrated development plans (IDPs).
- Municipal Structures Act (Act 117 of 1998), which defines municipal functions and powers and relating systems and structures.
- Municipal Finance Management Act (MFMA) (Act 56 of 2003) which defines financial management and accounting processes. In the case of water boards, which are "national government business enterprises", the equivalent legislation is the Public Finance Management Act (PFMA) (Act 1 of 1999).
- Division of Revenue Act facilitates financing of infrastructure grant funding and the equitable share.
- Water Services Act (Act 108 of 1997), which, among other things, requires WSAs to prepare WSDPs

Other legislation and strategy documents applicable to the water sector:

- The National Water Act (Act 36 of 1998)
- Strategic Framework for Water Services (DWA et al 2003)
- National Water Resource Strategy (DWA 2004)
- Occupational Health and Safety Act (Act 85 of 1993)
- National Environmental Management Act (Act 107 of 1998)
- Environmental Conservation Act (Act 73 of 1989)
- National Health Act (Act 61 of 2003)
- Disaster Management Act (Act 57 of 2002)

PHYSICAL INTEGRITY

2.1 Introduction

A water distribution system acts as a conduit to reliably transport adequate quantities of safe drinking water to consumers. To achieve this, the system needs to work as intended and maintain a physical barrier between the water inside the network and the external environment.

The physical integrity of the system refers to its ability to have correctly functioning components and maintain a physical barrier between the water in the network and the external environment. Another definition of physical integrity is the ability of a distribution system to handle internal and external stresses in such a way that its components do not fail. Internal stresses include things like operating pressure variations, water hammer and internal corrosion, while external stresses include soil stresses, external loadings and external corrosion.

The physical integrity of the system refers to its ability to have correctly functioning components and maintain a physical barrier between the water in the network and the external environment.

A water distribution system consists of a complex combination of components, including pipes, fittings, pumps, reservoirs, valves, hydrants, meters and backflow preventers that are all critical in maintaining physical integrity. At the same time, the distribution system is constantly changing through aging, replacement of components and the addition of new extensions. Table 1 provides a summary of the common components of a water distribution system, what external threats they protect against, and the common materials used in these components.

Table 1 Infrastructure components, what they protect against and common materials^f

Component	External threats the component protects against	Common materials used
Network pipes	Soil, groundwater, sewage contamination, surface run-off, human activity, animals, plants and pathogens.	Cast iron, ductile iron, steel, asbestos cement, PVC and polyethylene.
Plumbing pipes	Human activity, sewage and non-potable water.	Copper, iron, steel, PVC, polyethylene, polybutylene.
Fittings (meters, valves, hydrants, etc.)	Soil, groundwater, sewage contamination, surface run-off, human activity, animals, plants and pathogens.	Cast iron, brass, steel, rubber, plastics.
External coatings and wraps for pipes and fittings	Supporting role in that it preserves the pipe integrity from external threats.	Zinc (galvanising), polyethylene, bitumen coating, bitumen wrapping, cement-mortar.
Internal linings for pipes and fittings	Supporting role in that it preserves the pipe integrity from internal threats.	Zinc (galvanising), epoxy, urethanes, bitumen, cement-mortar, plastic inserts.
Storage facility walls, roof covers and vent hatches.	Air contamination, rain, algae, surface runoff, human activity, animals, birds and insects.	Concrete, steel, cast iron, bitumen, epoxy, and plastics.
Backflow prevention devices	Non-potable water	Brass, ductile iron, plastics.
Gaskets and joints	Soil, groundwater, sewage contamination, surface run-off, human activity, animals, plants and pathogens.	Rubber, leadite, bitumen, plastics.

2.2 Consequences of loss of physical integrity

There are three important consequences of a loss of physical integrity:

The system is *unable to function as intended* due to components not working as intended, whether due to failure or wrong settings.

Loss of water from the system through leaks and overflows, resulting in this water not reaching consumers.

The *risk of contamination* of the water in the system by external pollutants. These may be chemical or biological pollutants, or the introduction of particles such as sand or grit.

2.3 Causes of a loss of physical integrity

Numerous factors and mechanisms can lead to a loss of physical integrity. These factors may be categorised as design and construction, physical and chemical factors.

2.3.1 Design and construction factors

Operation and maintenance of a water distribution system is highly dependent on the way the system is designed and constructed (including modifications and repairs), and problems in these phases can result in major operation and maintenance problems. The main ways in which problems design and construction can lead to a loss of physical integrity are as follows:

- **Design faults** can lead to component failure, for instance when an insufficient pipe wall thickness (i.e. pipe class) is specified for the water hammer pressures experience in a pipe, or when materials susceptible to corrosion damage is used in an aggressive environment.
- **Defective materials** containing flaws that were not identified in the manufacturing process, such as microscopic cracks in steel or impurities trapped in plastic pipes.
- **Missing or defective parts** as a result of improper design or construction. Examples include missing or defective covers on reservoirs or insect barriers on air vents.
- **Improper construction or repair.** During construction or repairs the system is open to the surrounding environment and thus the physical integrity is compromised. Careful cleaning and disinfection of the exposed section of the network is required to ensure it is safe before being put in use.
- **Improper use**, or using components and materials outside their operating specifications.
- **Cross connections.** In some areas, non-potable water is provided through a parallel pipe network, for instance for industrial or agricultural use. A cross connection made between the drinking and non-potable network can result in contamination of the drinking water system.

2.3.2 Physical Factors

Various physical factors can cause a loss of physical integrity, including the following:

- **Excessive loads.** Loads or forces that exceed the strength of a material can lead to failure through cracking or rupture. This may be caused by external forces such as point loads (e.g. through a sharp rock in the pipe bedding), the weight of the soil above the pipe, external loads such as buildings or traffic and soil movements, or internal forces exerted by the water on the network components. Internal loads are caused by three mechanisms:
 - Water **pressure** creating stresses in the walls of pipes and fittings.
 - **Changes in the momentum** (i.e. direction or velocity) of flow in pipes at bends, junctions, reducers, valves and other fittings.
 - Transient or **water hammer** pressure waves created by sudden changes in the flow rate, such as a sudden valve closure or pump stoppage.

- **Damage** to components may result from construction activities or vandalism.
- **Erosion** is caused when material is removed from a component through a scouring action. This is sometimes observed outside leaks in pipes where the soil outside the leak is agitated causing the material to be eroded away. A leak may also erode the soil supporting the pipe, resulting in sagging and pipe failure due to an increased loading.
- **Exposure to sunlight** can damage certain materials such as PVC, and thus care should be taken not to lay PVC pipes above ground or leave them exposed to the sun during construction.
- **Cavitation** is a process whereby the pressure in the water is lowered below its saturation vapour pressure, causing small vapour bubbles to form. When these vapour bubbles are then suddenly moved to a high pressure zone, for instance inside a pump, they become unstable and implode, causing high intensity pressure waves in the fluid. These pressure waves can remove small amounts from a solid surface near the implosion point and slowly erode the material over time. Cavitation can cause serious and costly damage to pumps that are incorrectly installed or operated.

2.3.3 Chemical Factors

2.3.3.1 Corrosion

Corrosion is the degradation of a material by chemical reaction with its environment. Three types of corrosion are important for

water distribution systems i.e. galvanic, electrolytic and microbiological corrosion.

- **Galvanic corrosion** is an electrochemical process that occurs when two different metals are electrically connected and immersed in a suitable, typically an acidic, fluid. A galvanic cell is formed under these conditions, resulting in an electrical current flowing from one metal (called the anode) to the other metal (called the cathode) through the electrical connection. As the anode loses electrons, atoms of the anode metal are released into the fluid, resulting in a loss of material. At the same time, ions in the fluid are deposited on the surface of the cathode, thus covering or plating it. (The same process is used to galvanise metals with zinc, or plating jewellery with gold). In water distribution systems, soils generally contain enough water and the right conditions for galvanic cell to form. Metal pipes typically form an anode, causing corrosion damage to occur over time.
- **Electrolytic corrosion** occurs when a direct electrical current takes a shortcut through a metal pipe or component. Such a current is called a “stray current”, and may be caused by a cathodic protection system on an adjacent pipeline or electric railway systems. Electrolytic corrosion is similar to galvanic corrosion, except that outside current sources drive the electrolytic reaction, whereas chemical reactions drive the galvanic cell. When a stray current moves through a metal pipe, corrosion occurs at the point where current leaves the pipe.

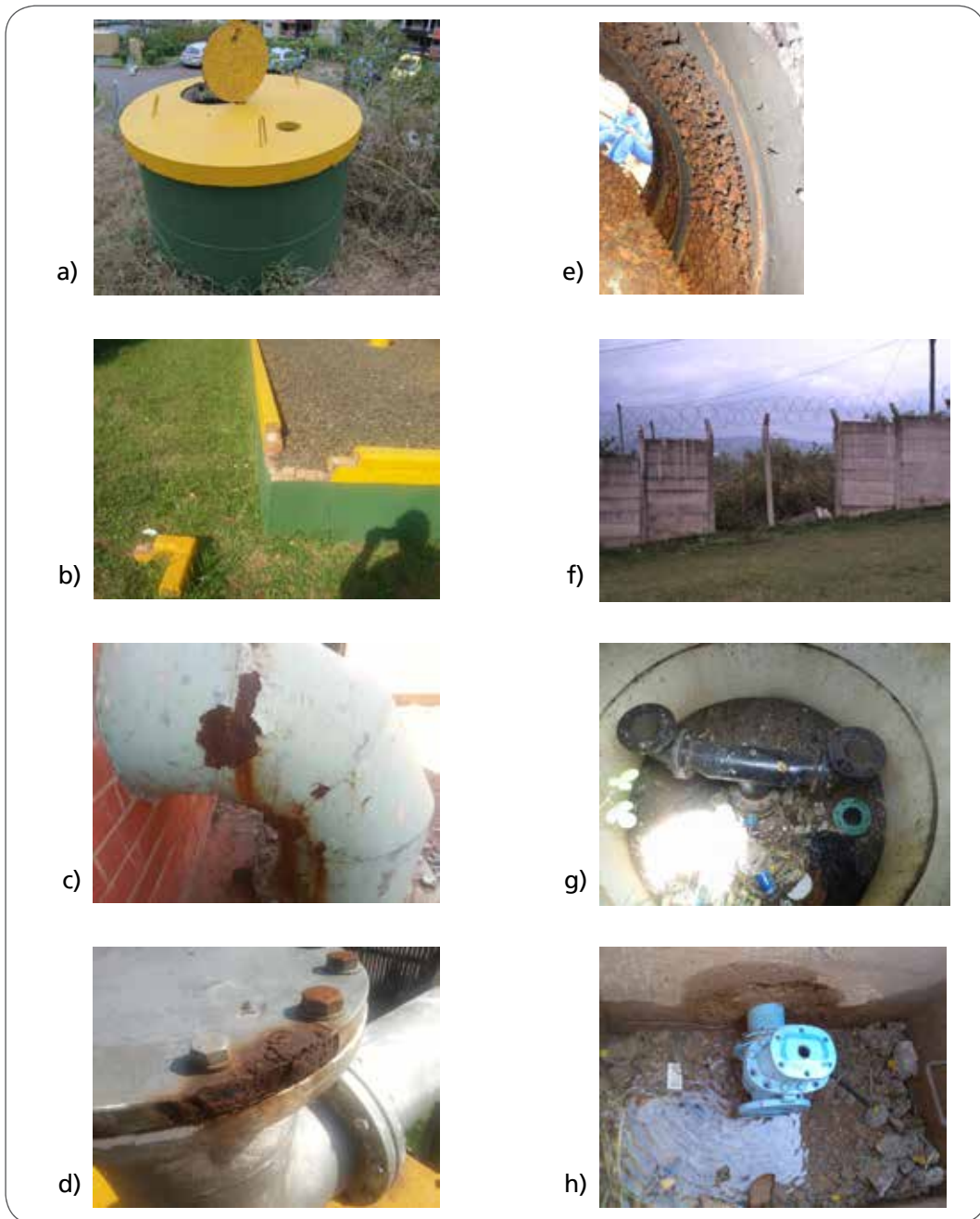

Figure 4 Examples of processes leading to a loss of physical integrity: a) missing air vent on an air valve chamber; b) damage to brickwork on a reservoir roof; c) external corrosion on a steel pipe; d) external corrosion on a pipe flange; e) internal corrosion in a steel pipe; f) vandalism damage to a reservoir fence; g) theft of air valves; h) vandalism damage to a scour valve.

- **Microbiological corrosion** is corrosion that is caused or influenced by microorganisms. This can be a problem in soils with low oxygen levels (or low redox potential), which creates the potential for anaerobic microbiological activity.

Corrosion occurring inside the distribution system is called internal corrosion, while corrosion occurring on the outside is called external corrosion. Corrosion can lead to failure of components by creating a hole in the material, or weakening it to such an extent that it fails due to internal or external loads.

External corrosion of buried components is exacerbated by ^f:

- Low soil oxygen levels, creating the potential for anaerobic microbiological activity.
- Soils with low pH values, i.e. acidic soils.
- Stray electrical currents in the soil that may take shortcuts through metal pipes.
- Galvanic reactions caused by different types of metals in contact with each other.

Internal corrosion causes problems in distribution systems that are commonly grouped as follows ^h:

- **Pipe degradation** (e.g., pitting), which can result in leakage or vulnerability to mechanical failure.
- **Tuberculation** or the build-up of corrosion products on the inside of the system that reduces hydraulic capacity and impairs water quality.

- **Corrosion by-products** that impair the quality of the water, typically by causing red, rusty water.

The rate of internal corrosion can be influenced by the physical, chemical and biological characteristics, in particular the pH and alkalinity of the water, disinfectant type and dose, types of bacteria occurring in biofilms, water velocity and the use of corrosion inhibitors.

2.3.3.2 Permeation

Permeation refers to a mechanism of pipe failure in which contaminants on the outside of the pipe compromise the structural integrity of the pipe in such a way that they can pass through it and into the water ^h. Permeation occurs when plastic pipes come in contact with chemical solvents associated with oil and petrol. Users downstream of a permeation failure often notice a chemical taste or smell in the water. The presence of these contaminants can be determined through volatile organic chemical gas chromatography analysis. These contaminants are common in soils surrounding leaking storage tanks, fuel spill sites, industrial sites, and near bulk chemical storage, electroplaters and dry cleaners ^h. In some cases the integrity of the pipe can be irreversibly compromised, requiring the complete replacement of the affected section.

2.4 Measuring physical integrity

The physical integrity of the system can be measured in various ways. Components that are not buried can be visually inspected for signs of deterioration or failure.

Underground pipes and components can be inspected by opening sections of the pipe, for instance when it is necessary to make new connections or repair pipe bursts. Pipes and valves can be evaluated using pressure tests.

Various internal inspection and sounding techniques exist to find leaks on pipes in water distribution systems. It is also possible to get indirect measures of the deterioration of the system by looking at trends in pipe failures, estimating the leakage rate in the system and testing the water quality.

Consumer complaints are a valuable source of information on system integrity and should be monitored for indications of a loss of physical integrity, including reports of leaks and broken components.

2.5 Maintaining physical integrity

Various measures should be taken to maintain the physical integrity of a distribution system and counteract threats. It has already been mentioned that design and construction practices play an important role in the operation and maintenance of a water distribution system. For this reason, an overview of design and construction measures that support good operation and maintenance practices are included in the book, in addition to specific operation and maintenance measures.

This section focuses on generic measure for maintaining physical integrity of water distribution systems that apply to most components. Measures that are specific to particular system components are discussed

in Part 2 of this book.

2.5.1 Design and construction

2.5.1.1 Design

It is critical that operation and maintenance are considered at the design stage, whether for a new system or when considering amendments to an existing system. Small increases in capital costs, for instance by selecting a different pipe diameter or more durable material, may result in major operation and maintenance savings over the lifetime the system.

A good example of the trade-off between capital and operational costs is the design of a new pumping line between a source and a reservoir. Consider a case where the designer can choose between a smaller and larger diameter pipe for the system. The smaller diameter pipe will be cheaper to construct, but since it will have greater friction losses, more energy (and thus higher operational cost) will be required to pump the water. Conversely, the larger pipe diameter will be more expensive to construct, but will have lower losses and thus require less energy to operate.

The correct approach would be for the designer to calculate the total capital plus operational cost of the system in the current value of money (by taking the interest rate and inflation into account), and the select the pipe diameter that will have the lowest cost over the lifetime of the system. Various similar trade-offs between capital and operational costs are possible.

A very important factor in design is durabil-

ity. Cheaper components that will fail more often and have to be replaced earlier may not really be cheaper if these costs are taken into consideration. Thus it is important to maintain a long-term view when making design decisions.

All user connections should have non-return valves to ensure that water delivered cannot return to the network, for instance under reduced pressure conditions.

Vandalism and theft in critical areas may be controlled through the installation of alarms or other deterrents.

2.5.1.2 Materials selection

Material selection is a key part of design. The following factors should be considered when selecting the material used for distribution system components ^f:

- The potential water quality and health effects of materials in contact with drinking water
- Hazards and safety in working with the materials
- Structural capabilities
- Cost and availability
- Durability and expected service life.
- Compatibility with other materials in the system, the distribution water and the surrounding soils
- Environmental impact
- Wall roughness of pipe materials
- Ease of use in construction

Different metals should not be in direct

contact with each other, especially on the outside of pipes, as this can lead to corrosion.

Finally, it is advisable to limit the number of materials and types of components used in the system as each new type of component requires the maintenance workshop to hold an inventory of spare parts to be used for maintenance. Maintaining a large inventory is both logistically difficult and expensive.

2.5.1.3 Workmanship and quality control

Quality of work in construction, repair, refurbishment and replacement procedures are critical as problems in these steps may have serious and costly consequences over the lifetime of the distribution system. It is essential to use good quality control procedures and install components according to manufacturer specifications.

2.5.2 Operation

The operation of a water distribution system should be done in such a way that consumers are provided with a high quality service in the most cost-effective way. This includes the following:

- Maintaining *proper operational settings* in isolation valves, control valves, pumps and other components.
- Components should be *operated within their capabilities* and according to manufacturer instructions to ensure optimal benefit is obtained from them.

- Information on the *state of the system* is important for system operation. Thus sensors and communication equipment such as SCADA are required.
- Relevant *regulations and bylaws* should be complied with, both by municipal staff and the public.
- Components should be operated in line with the *system's operational strategy*. Isolation valves should be open or closed to ensure that district management zones are isolated and users are provided with a sufficient service.
- *Records* should be kept of all operational actions, such as opening or closing isolation valves, changing control valve settings or amending pump operational schedules. Appendix B contains a number of useful forms that may be used.
- Timeous repair, refurbishing and replacement of components (*preventative maintenance*). It is important to understand the service behaviour of different components in the system and repair, refurbish and replace them through proactive maintenance at the optimal time to minimize operational interruptions and costs.
- *Protect the system environment* to ensure that components are not exposed to unnecessary risks. This includes protection against vandalism or accidental human entry, prevention of external water from entering the system and protection against organisms such as birds and insects.
- *Corrosion control* should be implemented to ensure that system components are not damaged. It is necessary to analyse system to determine areas where pipes and other components are vulnerable to corrosion, and then take appropriate steps to prevent it. For metal pipes, factors to use include soil resistivity, pH, redox potential, the presence of sulphides, and site drainage conditions^f. For concrete pipes, soil chloride content and resistivity should be considered. Methods for external corrosion control include selecting appropriate materials, applying protective coatings and linings, installing and maintaining cathodic protection systems and mitigating stray currents. Internal corrosion control methods include adding corrosion inhibitors, such as phosphates to water and adjusting pH and alkalinity to appropriate levels.

2.5.3 Maintenance

Maintenance actions can be classified into proactive and reactive maintenance. It will never be possible to only do proactive maintenance as unexpected failures are bound to occur even in the best-maintained system. However, it is important to do proactive maintenance to such an extent that unplanned failures are kept to a minimum and resources can be used in the most effective way to ensure the integrity of the system. A number of general maintenance principles are important in this process.

- *Condition monitoring* of components is important to know their condition and performance histories.

- **Cross connection control.** In systems with dual water systems that provide different quality water (for instance for industrial processes, gardening or fire fighting), it is essential that appropriate steps are put in place to prevent accidental cross-connection between the systems.
- **Backflow prevention.** Water supplied to consumer installations should be protected from being able to enter the system again through check valves or other measures where appropriate.
- **Records** should be kept of all maintenance actions.

2.6 Common materials used in distribution systems

The basic properties of common materials used in water distribution systems are introduced in this section.

2.6.1 Asbestos cement

Asbestos cement (AC) or fibre cement is manufactured from cement with 15 – 20% asbestos fibres added to give it tensile strength. It was a popular pipe material from the 1970s to the 90s. Asbestos cement had significant cost and handling advantages over iron before the arrival of plastics. It is resistant to corrosion, except for water with a low pH. Asbestos cement material is brittle, tending to crack under external loads and is difficult to repair. Asbestos is also associated with health risks when inhaled, and thus should be handled and cut with utmost care. However, it is considered as safe material for water supply and thus it

is not necessary to replace existing AC pipes in a system due to health concerns.

2.6.2 Bitumen

Bitumen is a black solid form of petroleum (i.e. a hydrocarbon substance) that is sticky and highly viscous when melted. It has been popular as a pipe coating and liner to protect the pipe material from corrosion.

2.6.3 Cement and concrete

Concrete is a composite material consisting of aggregate or sand bound together by cement. It is a versatile material used for foundations, pump stations and other buildings, valve chambers, anchoring and pipe linings. Sometimes pipes are encased in concrete to protect them from external loads. Concrete is also used as a pipe material when reinforced with steel wire.

Proper mix design, placement and curing of the concrete by an experienced contractor are essential to ensure it performs as intended. The mix design depends on the type of structure being built, how the concrete will be mixed and delivered and placed. Less water in the mix yields a stronger, more durable concrete, but less water means a stiffer mix, which is more difficult to work with ^d.

Concrete is mostly resistant to normal internal corrosion of water pipes, making it suitable as a lining material. However it cannot handle tensile forces and tends to form cracks and scaling due to temperature fluctuations. Since concrete is an alkaline material, it can be attacked by acidic chemicals. Thus the pH of water should be

high enough to prevent corrosion of pipe linings and concrete reservoirs. Carbon dioxide gas is a major factor contributing to the deterioration of concrete, although this happens slowly due to the low levels of carbon dioxide in the atmosphere.

High levels of magnesium, ammonium and sulphates in water result in chemical reactions that damage concrete surfaces. Steel reinforcing in concrete is susceptible to attack by chlorine if network water is able to reach it through cracks in the concrete cover. When the steel corrodes, it expands causing further cracking of the surrounding concrete and thus accelerating the deterioration process. This process is known as spalling.



Figure 5 Efflorescence on the outside of a water retaining structure.

Reservoir walls sometimes form a whitish, crystallized substance called efflorescence, caused by water seeping through cracks and pores in the concrete (see Figure 5). When the water evaporates, it leaves behind mineral salts leached from the concrete. These salts often seal the openings in the concrete, thus stopping further movement of water through the structure. However, when the salts recrystallize, they expand causing break-up of the concrete surface. This is normally not a serious problem, but should be monitored and action taken if serious damage is likely to occur.

Abrasion or erosion of concrete is caused by other materials rubbing over the concrete surface, for instance windborne sand. Minor erosion is normally not a problem, but severe erosion may lead to serious structural damage. Finally, since concrete is a brittle material, pieces may break off structures when subjected to impact loads.

2.6.4 Copper and Brass

Copper pipe is often used for small diameter pipes such as in plumbing systems. It is resistant to corrosion, but is an expensive material to use. Copper pipes are susceptible to corrosion pitting caused by contamination of the pipe interior, typically by soldering flux and stray current corrosion due to insufficient grounding of the pipes.

Brass is an alloy made of copper and zinc. It is often used in components such as water meters and taps. Brass is susceptible to corrosion under certain conditions, such as high water temperatures, the presence of chlorides and soft water (water with low levels of minerals such as calcium and mag-

nesium). Under these conditions, dezincification resistant (DZR) brass has to be used.

Due to its value as a material, copper and brass fittings may be subject to theft and thus should be avoided in areas where this might be a problem.

2.6.5 Iron and Steel

Cast Iron

Cast iron pipes were commonly used up to the middle of the 20th century. As the name implies, these pipes are cast, typically using a centrifugal process. Cast iron has a carbon content of 2.5 to 4 % and a silicon content of 1 to 3 %. It is often called grey cast iron, since the exposed surface when it breaks has a grey colour.

Cast iron pipe has been largely phased out due to cost and its susceptibility to both internal and external corrosion. It is still sometimes used for certain components, such as valves, pumps and hydrants.

Ductile Iron

Ductile iron is a type of cast iron where the graphite particles in the iron are in a nodular form, rather than the flake form found in cast iron. This gives it greater strength, ductility and impact resistance than cast iron. However, like cast iron pipe it is subject to both internal and external corrosion, and thus need to be protected with linings and coatings. Ductile iron replaced cast iron as a popular pipe material in the second half of the 20th century.

Steel

In steel, the carbon content is reduced to between 0.002 % and 2.1%. Lowering the carbon content in steel reduces its hardness and strength, while increasing its ductility. Increasing the carbon content has the opposite effects. Like cast iron and ductile iron, steel is subject to both internal and external corrosion. Steel is used for pipes, a structural material in buildings and reinforced concrete, and in many components used in water distribution systems.

Stainless steel

Stainless steel is a steel alloy with a minimum of 10.5% chromium content. This makes it highly resistant to corrosion and an excellent material to use in components that are in contact with water. Stainless steel is expensive, preventing its wider use in practice. However, certain municipalities have concluded that the durability of stainless steel makes it the material of choice. In such municipalities, Grade 316 stainless steel is used for underground installations and above-ground installations outside, while Grade 304 stainless steel is used inside buildings such as pump stations.

2.6.6 Polyethylene

Polyethylene is a thermoplastic polymer consisting of long hydrocarbon chains. It is the most common type of plastic and is used for various applications including plastic bags and bottles. High-density polyethylene (HDPE) actually has only a slightly higher density than low-density polyethylene (LDPE), but due to differences in the chemical bonding, it has greater

strength and can handle higher temperatures. HDPE is a commonly used pipe material that is tough, flexible and corrosion resistant. HDPE pipe is flexible and can thus be supplied in rolls instead of straight lengths. This means fewer joints, which is an advantage if the jointing is done well. However, the welding used to join HDPE pipes requires a high level of workmanship, which is sometimes difficult to achieve in the field.

2.6.7 PVC

PVC or polyvinyl chloride is a plastic used for various purposes in the construction industry, as well as for clothing, electrical cable insulation and inflatables. Various additives such as plasticizers are used to improve certain characteristics of the material. For pipe and construction applications, plasticizers are not used leading to the term uPVC (Unplasticised PVC). Modified PVC or mPVC incorporates an additive that makes the material less likely to fracture on impact and allows for lower wall thicknesses. In oPVC (oriented PVC), the molecules are oriented to give the material greater strength in certain directions. PVC has a high harness and strength, and is resistant to corrosion. It is not suitable for high temperature applications though, and PVC pipes should not be exposed to direct sunlight. Chlorination of PVC makes it more resistant to high temperatures and thus chlorinated PVC (cPVC) pipes are sometimes used for hot water applications.

2.6.8 Rubber

Rubber is an elastomer and a thermoplastic that originates from certain trees or can be produced synthetically. It is widely used in many applications and products. Rubber is able to stretch a great deal, has high resilience and is extremely waterproof, making it ideal for gaskets and seals.

2.6.9 Glass reinforced plastic (GRP)

Glass-reinforced plastic is a composite material that uses glass fibres embedded in a thermosetting resin, often in combination with other materials to give it desired properties. It is highly resistant to corrosion and is sometimes used as a pipe material for large diameter pipes.

2.6.10 Other materials

Epoxy is the cured end product of epoxy resins, a class of reactive polymers. Epoxy resins are applied and then cured through the use of catalysts or reactants to form a hard polymer with strong mechanical properties and high temperature and chemical resistance. Epoxy is often used to coat metal pipes or components as a barrier against corrosion.

Lead is an element that is known to have adverse health effects, especially for children and pregnant woman. It may be found in brass, soldering used for plumbing pipes and seals in old cast iron pipes.

Polybutylene is a saturated polymer used in pressure pipes, especially plumbing pipes.

Polypropylene or polycop pipes are used as a plumbing pipe material.

Additional Reading

- Committee on Public Water Supply Distribution, National Research Council. (2006). Drinking Water Distribution Systems: Assessing and Reducing Risks. Washington, D.C.: National Academies Press. The book can be downloaded for free or ordered from http://books.nap.edu/catalog.php?record_id=11728.

HYDRAULIC INTEGRITY

3.1 Introduction

While it is important to provide a physical barrier between the water in a distribution system and the external environment through functioning components, physical integrity is not enough in itself to provide water to consumers. It is also necessary for the system to have hydraulic integrity. For example, a pipeline may be in good physical condition (thus have physical integrity), but too small to provide the user demand at adequate pressures (and thus lack hydraulic integrity).

Hydraulic integrity is the ability of a distribution system to meet all user demands (domestic, industrial, commercial, fire fighting, etc.) while ensuring desirable pressures, velocities and water age in the system.

Pressure is the most important indicator of hydraulic integrity. System pressures are at their highest during the night, when flows and energy losses are at a minimum. Conversely, system pressures are at a minimum during peak demand periods when flow rates and energy losses are at a maximum. Design guidelines specify the minimum and maximum pressures in water

distribution systems to be 24 and 90 m respectively. The upper bound of 90 m is very high, and some municipalities use a lower maximum pressure specification.

Hydraulic integrity is the ability of a distribution system to meet all user demands (domestic, industrial, commercial, fire fighting, etc.) while ensuring desirable pressures, velocities and water age in the system.

Three ways to express pressure

Pressure is defined as force per unit area and is a very important quantity in hydraulic engineering. There are three common units in which pressure is expressed.

- **Pascal (Pa)** is the standard scientific unit in which pressure is measured. One Pascal is the pressure exerted by a force of 1 newton on an area of 1 m². One Pascal is a very small value – approximately the pressure exerted by a sheet of paper. For this reason, pressure is more often expressed as kiloPascal (kPa), where 1 kPa = 1000 Pa.
- **Bar** is another unit of pressure used for large pressures, with 1 bar = 100 kPa. One bar is approximately equal to atmospheric pressure.
- **Pressure head.** Pressure head is measured in length units (typically metres) and is the height to which water will rise in a vertical tube placed on top of a pipe or pressure vessel. If, for instance, a thin and long vertical pipe is connected to a distribution mains that has a pressure head of 20 m, the water rise in the vertical pipe to a height of 20 m above the pipe.

The term “pressure” is often used instead of the technically correct “pressure head”. However, this is not a problem since the units used (metres or Pascal) make it clear which form is used.

To convert from pressure head to pressure, the following formula is used:

$$p = \rho gh$$

Where p is pressure (in Pa), ρ the density of water (1000 kg/m³) and h the pressure head (in m). From this formula it is possible to calculate that a pressure head of 20 m is equal to 196 kPa or 1.96 bar.

3.2 Consequences of a loss of hydraulic integrity

A loss of hydraulic integrity can have severe consequences for service provision in a water distribution system, including the following:

- **Inability to satisfy consumer demand** due to inadequate system pressures.
- **Damage** to pipes and linings due to negative pressures.
- **Contamination** of the water in the system by external pollutants due to negative pressures.

- **Depletion of disinfectant residuals** due to long retention times of water in the system.
- **Accumulation of sediments** in pipes due to low velocities.

3.3 Causes of a loss of hydraulic integrity

Numerous causes of a loss of hydraulic integrity may be identified. In most cases an interaction between loss of hydraulic, physical and water quality integrity exists. For instance, a negative pressure event in the system (loss of hydraulic integrity) may lead to contaminated water outside the

Energy and hydraulic grade lines

The mechanical energy of a fluid depends on three parameters: its elevation (potential energy), pressure (another form of potential energy) and velocity (kinetic energy). The energy is commonly expressed per unit weight of fluid, which has convenient length units. In this form it is called energy head and it is typically measured in metres.

The Bernoulli equation describes the energy head of a fluid as the sum of its elevation, pressure head and velocity head as follows:

$$H = z + \frac{p}{\rho g} + \frac{v^2}{2g}$$

Where H is the total mechanical energy head, z is elevation above the datum level, p is pressure (in Pa), ρ the density of water (1000 kg/m³), g acceleration due to gravity (in m²/s) and v the flow velocity (in m/s).

An important measure in water distribution systems is the hydraulic grade, which is the sum of the elevation and pressure heads. Thus the hydraulic grade represents the fluid energy excluding the velocity head. In water distribution systems the velocity head is normally very small compared to the other two components, and thus the hydraulic grade is often used instead of the total energy.

The energy line (EL) and hydraulic grade line (HGL) are obtained by plotting the energy and hydraulic grade above a longitudinal section of a pipe. The energy line always slopes downwards in the direction of flow, and the drop in the energy line represents the loss of energy in the system. The figure below shows the HGL of a system during minimum flow conditions (early morning hours when demand is almost nothing) and under peak flow conditions (when demand is at a maximum).

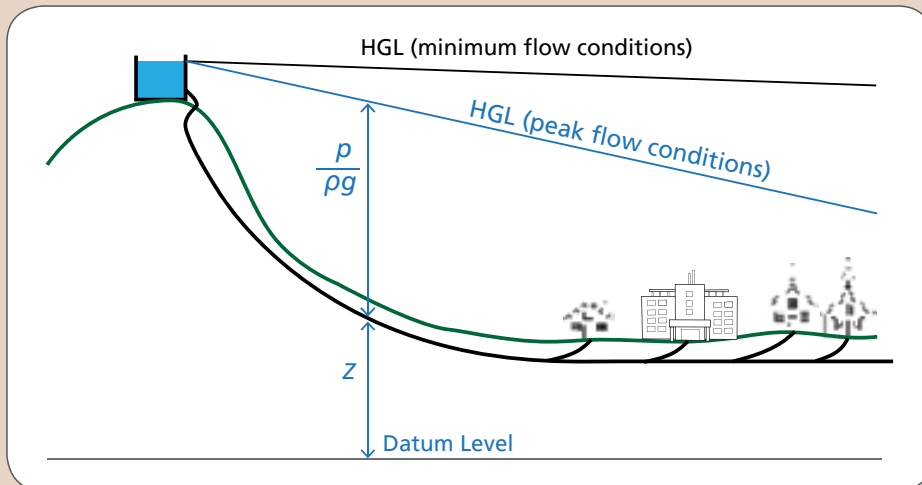

The height difference between the pipe and HGL indicates the pressure head, and thus the figure shows how the system pressure is at a maximum in the early morning hours and at a minimum under peak demand conditions.

system entering the pipe if a leak is present (loss of physical integrity), resulting in contamination of water in the system (loss of water quality integrity). In cases where more than one type of integrity is involved, the cause is only discussed under the most appropriate integrity heading.

3.3.1 Excessive demands

The components of a water distribution system are sized according to the design peak demand, which is the maximum demand that the system is expected to experience over its design horizon (typically 10 to 20 years).

Water demand is not constant, but varies with time: the average annual daily demand (AADD) tends to increase over time due to economic growth, densification and increased system leakage. There are also cyclical variations in the demand, such as seasonal, day-of-the-week and diurnal patterns. Finally, there are random fluctuations caused by user behaviour and unpredictable events such as fire fighting.

It is likely that the demand will exceed the capacity of the water distribution system at some point in its life as shown in Figure 6. Low pressures are most likely to be observed during periods of high demand such as during particularly hot and dry weather conditions, large fire fighting efforts or seasonal events such as the influx of tourist to coastal towns over holiday periods. A large pipe burst may also contribute to an exceptional system demand for a period.

The required minimum system pressure is typically around 24 m, but it is unlikely that consumers will notice much difference if the pressure only falls slightly below this level. However, as the pressure reduces further, the system becomes unable to supply the required demand of users in low-pressure parts of the network.

It is useful to consider the fact that users get water from the system by opening a tap or valve, and it is the pressure in the system that forces water out through the tap or valve. Thus lower pressures result in a reduced supply capacity of the system.

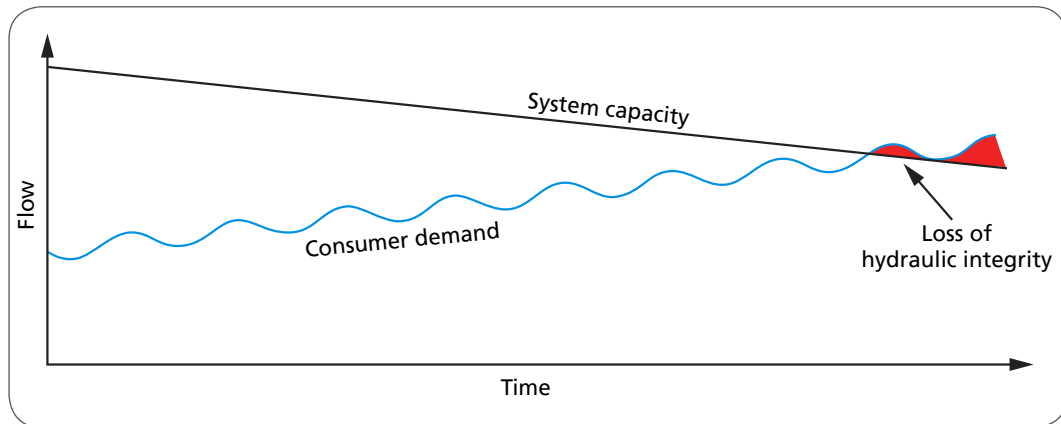

Figure 6 Variation in system capacity and water demand with time

Low pressures aren't experienced equally by all users, but are mainly felt by those users at the furthest and highest points in the network. Complaints of low pressures are often a good indication that the system's hydraulic integrity may be compromised.

3.3.2 Reduction in system capacity

Pipes deteriorate with age in several ways that may affect the hydraulic integrity of the system. The hydraulic capacity of pipes is reduced over time by build-up of deposits on internal pipe surfaces and an increase in wall roughness. Scales may form due to high concentrations of metal salts such as calcium carbonate and aluminium silicate in treated water. In iron pipes, corrosion by-products in the form of tubercles and other types of scales can substantially reduce internal diameter and increase pipe roughness. In addition, older pipes are more likely to experience bursts that reduce the system capacity through increased leakage flow rates. The reduction in system capacity is shown graphically in Figure 6.

The hydraulic capacity of a water distribution system is reduced when components are shut down for maintenance or to isolate sections that experience bursts or external damage. Since water distribution pipes are normally looped, most users downstream of the affected section should still be supplied with water through alternative routes. However, isolating sections of the system will inevitably lead to a reduced system capacity to these users, and may thus result in reduced pressures. Low pressures may also result from a valve left open, for instance between two district metering zones.

3.3.3 Negative pressures

In extreme cases the demand exceeding the system capacity can lead to pressures in the system dropping below atmospheric, i.e. become negative. This is a particularly undesirable situation, as negative pressures will suck in contaminated water from outside the system when a hole or crack is present in the pipe. Sources of contaminated water include sewage and chemical spills, ground water surrounding pipe leaks and flooded chambers.

Air sucked into the system may stir up sediments and produce discoloured water, and air flowing through water meters cause reading errors and may damage meter by exceeding their maximum flow rates.

If negative pressures are severe, pipe linings may be cracked or damaged, and in large diameter pipes may even cause pipe collapse.

3.3.4 Pumping directly from the network

Consumers experiencing low supply pressures may be tempted to have a pump installed to boost the pressure to their properties. However, connecting the suction side of a pump directly to the network exacerbates the problem in two ways:

- While the pump may boost the pressure in the building it is installed in, the increased demand on the system lowers the pressure further for other nearby consumers, and thus reduces their level of service.

- Pumps can induce negative pressures in the system, leading to ingress of contaminated water into the system and a health risk to consumers.

Thus pumps that connect directly to the network should be prohibited through municipal bylaws. Private pressure pumps should always be supplied from a private water tank that is open to the atmosphere and filled from the network. This will make it impossible for the pump to induce negative pressures in the system.

One possible exception to the above rule is the use of pumps for emergency situations such as fire fighting. However, even in these cases it is advisable to require a soft pipe connection between the fire hydrant and the fire pump. Unlike rigid connections, soft connections will close when the suction pressure reduces below zero, thus making it unlikely that negative pressures are induced in the network. Fire pumps can be very powerful and may cause negative pressures that cause damage to pipes and their linings.

3.3.5 Pressure transients

Pressure transients or water hammer occurs when sudden large changes occur in the flow rate of a pipeline. Examples include a valve that is suddenly closed, or a pump that is suddenly stopped. The effect of a sudden change in pipe flow rate is to induce an increasing or decreasing pressure wave that travels at high speed (500 – 1000 m/s) through the pipe. When it reaches the end of the pipe, it is reflected back in the opposite direction and inverted (increasing pressure waves becomes decreasing pressure

waves and vice versa). The intensity of the wave reduces as it oscillates through the pipe until it is exhausted.

If pipes are not properly designed, increasing transient waves can exceed the strength of the pipe, causing damage to linings or inducing a pipe burst.

On the other hand, decreasing transient waves may reduce the pressure below atmospheric, creating the potential for contamination of water as well as damage to pipe linings and structure. In extreme cases, column separation can occur during low-pressure cycles, creating severe pressure spikes when these cavities collapse during high-pressure cycle.

3.3.6 Excessive pressures

Pressures that are too high can also cause problems, including higher leakage rates (leakage has been found to be very sensitive to system pressure), more new leaks forming, reduction in pipe service life and the risk of damage to consumer fixtures such as geysers and washing machines.

3.3.7 Low velocities

The residence time of water in the system (i.e. the time it takes water to move from the water treatment plant to the consumer) should be kept as short as possible since longer residence times increases the risk of chlorine depletion and disinfection by-product formation.

Certain minimum velocities should be regularly exceeded to prevent settled particles from accumulating in the bottom of

pipes. This is done by using smaller pipe diameters and looped networks. If it isn't possible to avoid low velocities, municipalities should introduce a systematic flushing programme to remove accumulated sediments from affected pipes.

Sediments serve as a food source for bacteria and create a hospitable environment for microbial growth. If not removed these materials may cause water quality deterioration, taste and odour problems, or discoloration of the water. This is particularly evident if the sediments are disturbed by sudden changes in the flow of water, for instance as a result of a pipe break.

Finally, reservoirs and pipes that are too large cause water to have increased residence times in the system, creating opportunities for a reduction in water quality through chlorine depletion and disinfection by-product formation.

3.3.8 Wrong operational settings

Operational settings, such as isolation valves that are wrongly open or closed or wrong settings on control valves may cause a loss of hydraulic integrity. It is thus important that operations teams should be trained on the proper way to operate the system and should record all operational actions, including simple actions such as opening or closing a network valve.

3.3.9 Air in the system

Air can enter the distribution system dissolved in the water, when the system is drained for maintenance purposes or during negative pressure events. Air trapped

when the distribution system is operational is compressed due to the pressure in the system. When these air bubbles are released through a tap or leak in the pipe, they rapidly expand when the pressure is released, causing a sudden 'explosion' that may unexpectedly accelerate water exiting the system, or even damage system components such as shower heads.

3.4 Measuring and modelling hydraulic integrity

Hydraulic integrity is primarily determined from pressure measurements in the system. Ideally, reservoir water levels and system pressure should be monitored continuously. Unexpected changes to pressure may indicate problems such as closed valves or pipe bursts in real time. Typical measuring points include critical points in the network, such as the furthest and highest points, as well as the suction and delivery sides of pumps and control valves.

Flow rate should also be measured at critical points such as sources, bulk supplies, both inlets and outlets of reservoirs, transfers to other municipalities and consumers.

Critical measurements should be communicated to the system control room through a SCADA or alternative communication system, and in advanced cases, this data is used in combination with a hydraulic network model of the system to continuously monitor the hydraulic state of the system.

Consumer complaints are a valuable source of information on system integrity and should be monitored for indications of a

loss of hydraulic integrity, including reports of low pressures and water discoloration.

3.5 Maintaining hydraulic integrity

To maintain the hydraulic integrity of water distribution systems and ensure the best possible water quality, residence times in the system should be kept as short as possible and large fluctuations in flows and pressures, as well as low flows and pressures should be avoided ^f.

Hydraulic modelling is an important operational tool and can be used to investigate alternative operational methods, for instance when taking a pipe or reservoir out of operation, anticipate future problems and training of operators.

This section focuses on generic measures for maintaining hydraulic integrity of water distribution systems that apply to most components under the headings of design and construction, operation and maintenance.

3.5.1 Design and Construction

Various design considerations are important ensuring hydraulic integrity ^f:

- **Provide system redundancy** through the use of a looped pipe network, minimum pipe diameters and alternative water sources. Looped pipe networks has the advantage that each point in the network can be served through multiple routes, and thus water can be supplied to most consumers even when pipes are

isolated for maintenance work. It also improves the capacity of the network at any given point, and thus facilitates high demands, for instance for fire fighting.

System redundancy should also be provided in other ways, such as providing backup power supplies, pumps, storage and emergency connection points to other parts on the network. Redundancy can also be facilitated by ensuring an adequate number of isolation valves and hydrants placed in such a way that they allow for the isolation of sections of the system with minimum impact on the rest of the network ^l.

- **Use district-metering areas (DMAs).** District metering areas are sections of the network (typically consisting of about 2 000 stands) that are isolated from the rest of the system except for one metered supply point. DMAs form the basis for the system water balance, and allows leakage and pipe bursts to be monitored in manageable areas of the system.
- **Keep pressures as low as possible in the allowed range.** DMAs should ideally be selected in such a way that they can also be used as pressure management zones (PMZs) in which pressures can be kept as constant as possible. The pressure in a DMA should be maintained as close to the minimum level as possible, as excess pressures increase the burst rates and reduce the service lives of pipes, potentially increase leakage rates substantially, increase water demands and require more energy (in pumped systems).

- ***Avoid too low and high velocities.***
It is not always possible to avoid low velocities in remote parts of the network, especially when minimum pipe diameters are specified, but this should be done as much as possible. Dead-end pipes should be avoided, as they tend to be particularly prone to low velocities and resulting sedimentation.

High velocities mean that excessive energy losses occur in these pipes, and that cavitation may even occur in some cases, such as at partially opened isolation or control valves.

- ***Provide water hammer protection.***
Water distribution systems don't normally experience water hammer problems as changes in flow rates are mostly gradual and the interconnected nature of the network and many openings tend to dissipate transient pressures quickly. However, bulk supply pipes, especially pump lines, should be analysed for water hammer pressures and measures taken to ensure that these will not damage the system.
- ***Minimise water retention time.***
A primary reason for water quality problems in distribution systems is long water retention times. The design of a distribution system has to incorporate redundancy and additional capacity to accommodate long-term growth and cyclic variations in demand. Water retention times can be controlled through various measures, such as adjusting pump schedules, reducing the operational water level in reservoirs, ensuring that reservoirs don't have 'dead zones' (where pockets of water become

stagnant for long periods) and changing valving patterns.

3.5.2 Operation

Various operational measures are important to maintain hydraulic integrity:

- ***Monitoring*** of the operational parameters in a water distribution system should be done as widely as possible, starting with the flow rate at reservoirs, entrance to DMAs and pressures at critical points in the network.
- ***Hydraulic modelling*** is an important tool that can be used in combination with the monitoring data to identify problems and find operational solutions. Calibrated distribution system models can calculate the variations of flow, pressure, velocity, reservoir level, water age, and other hydraulic and water quality parameters throughout the distribution system. Such a model help identify areas of low or negative pressure and high water age, estimate filling and draining cycles of storage facilities, and determine the adequacy of the system to supply fire flows under a variety of demand conditions ^f.
- ***Positive water pressure*** should be maintained and the causes of low pressures investigated and rectified without delay. Direct pumping from the system should not be allowed, fire services should use soft couplings between the system and their pumps, and valves and pumps should be operated in such a way that negative pressures are not induced in the system.

- Where the risk of cross-connection to a non-potable network exists, it is advisable to maintain a ***higher pressure in the drinking water than the non-potable network***. This will ensure that non-potable water is unlikely to move from the non-potable to the drinking water networks even if a cross-connection occurs.
- ***Pressure management zones*** can be used to ensure that pressures are kept as low as possible without reducing them below the minimum required values.
- ***Reservoirs levels*** can be reduced during low demand periods to ensure that the retention time of water does not become excessive.
- ***Water metering*** should be done on all supply points and at other points in the network.

A master plan should be developed for the network and updated every few years. The master plan should look forward to identify risks and trends in the system, and consider operational plans and system expansions to deal with these well in advance.

3.5.3 Maintenance

Various maintenance measures are important to maintain hydraulic integrity:

- ***Flushing or cleaning of pipes*** should be conducted systematically to ensure that accumulated sediments are removed from pipes.
- ***Active leak detection*** should be conducted to find pipe leaks.
- Reported or discovered component failures should be ***repaired as soon as possible***.
- ***Quality control*** measures on repairs are critical to ensure that repairs are done properly and don't create new problems.

Additional Reading

Committee on Public Water Supply Distribution, National Research Council. (2006). Drinking Water Distribution Systems: Assessing and Reducing Risks. Washington, D.C.: National Academies Press. The book can be downloaded for free or ordered from http://books.nap.edu/catalog.php?record_id=11728.

WATER QUALITY INTEGRITY

4

4.1 Introduction

Water is indispensable for human health and wellbeing and is used for a wide range of activities including drinking, cooking, bathing, gardening and washing clothes. Thus it is of the utmost importance that water distribution systems provide water of a quality that will support and not harm health and wellbeing.

Water quality integrity describes the ability of a distribution system to deliver water of acceptable quality to its users. Water quality integrity is totally dependent on the water the distribution system receives from its source, whether a borehole, water treatment plant, reservoir or pipeline. However, it also means that the distribution system should not adversely affect the quality of the water it transports.

Water quality integrity is the ability of a distribution system to deliver water of acceptable quality to its users.

Water quality integrity has become the highest priority in many developed countries where it drives substantial investments in capital and operation and maintenance. The same levels of investment are not affordable in developing countries, which often have to focus on extending the provision of services to unserved communities. As a result, less emphasis is often placed on water quality, giving rise to the perception that this is a less important component of water supply.

However, water quality is in fact more important in developing than in developed countries. In developing countries consumers are more dependent on the water distribution system for a safe supply of drinking water, since they are generally not able to afford alternative supplies such as bottled water or home-treatment systems. People in developing countries also don't have access to the same standards of nutrition and medical care and have the world's largest populations of immunity-compromised people suffering from diseases such as HIV/AIDS.

Thus it is of utmost importance that municipalities do everything in their power to ensure water quality integrity. Water quality integrity is the ultimate test for the performance of an operation and maintenance system.

Water quality integrity is the ultimate test for the performance of an operation and maintenance system.

4.2 Properties of water

Water quality is a large and complex field and thus this section only provides a brief introduction to the associated properties of water.

Drinking water from any source and subjected to any treatment process may reasonably be expected to contain a large range of constituents. Some of these constituents are considered essential for human health, while others are considered as dangerous contaminants.

However, considering elements in water as either good or bad is an over-simplification and not accurate. It is well understood today that virtually all constituents in water are harmless at low enough concentrations and only become harmful when present at higher levels. Thus guidelines on water quality mostly specify allowable ranges, rather than the impossible target of completely removing constituents.

The South African Water Services Act prescribes compulsory national standards for the quality of potable water. This act requires every water supplier to have a water safety plan and a water quality monitoring

programme to ensure water quality standards are complied with. Minimum water quality standards are specified in SANS 241 – Drinking water °.

The most important properties and constituents of water are outlined in the rest of this section under the headings of physical, chemical and microbiological properties or determinants. (A determinand is a constituent or property of water that can be measured).

Note that some of these properties fit under more than one category, in which case they are discussed under the most appropriate heading.

4.2.1 Physical properties

The most important physical properties of water are discussed in this section. The South African guideline values from SANS 241 for these properties are listed in Table 2 and consists of the following:

- ***Disinfectant residuals*** are concentrations of the disinfectant used at the end of the water purification process that remain in the water as it moves through the distribution system. This provides a way to test that water is still safe for consumption, as the disinfectant residual will prevent the growth of harmful micro-organisms in the treated water. However too much disinfectant gives water an unpleasant taste.
- ***Colour***. Purified drinking water generally has a bluish tint when viewed in large volumes. However, organic matter and chemicals such as iron, manganese and copper can give the water a

different colour. Colour in the water is normally not harmful, but is sometimes deemed unacceptable on aesthetic grounds.

- **Electrical conductivity** is a measure of how easily the water conducts electricity. Pure water is a poor conductor of electricity, but dissolved salts increase its conductivity. Thus the conductivity of water gives an indication of the total dissolved salts in the water. Electrical conductivity (EC) is measured in milli-Siemens per metre (mS/m). Distilled water has an EC below 1 mS/m, while sea water has an EC above 150 mS/m.
- **Taste and odour.** Pure water is tasteless, but in practice water contains many constituents that give it its taste and odour. While people normally consider the taste and odour of water to be pleasant, certain chemicals and substances created by living organisms such as algae, fungi and other micro-organisms give it an unacceptable taste and/or odour. Unpleasant tastes or odours are generally not harmful, but are unacceptable on aesthetic grounds.
- **Total dissolved solids** are a measure of all the organic and inorganic substances present in the water.
- **Turbidity.** Solids dissolved or suspended in water will make it less transparent to light. Most waters contain microscopic particles of clay or silt, as well as organic matter. Turbidity is measured with a nephelometer based on the intensity of a light shone through a water sample in units called Nephelometric Turbidity Units (NTU). High water turbidity may make the water aesthetically unacceptable, and may indicate poor water quality caused by inefficient water treatment.
- **pH.** The pH of water indicates whether it is acidic or alkaline. The pH scale varies from 0 to 14, with a pH of 7 being neutral, i.e. neither acidic nor alkaline. Liquids with a pH below 7 are acidic (giving the water a slightly sour taste), with the acidity increasing as the pH decreases. Conversely, liquids with a pH above 7 are alkaline (giving the water a slightly soapy taste), with higher alkalinity water having higher pH values. The important role of pH is in controlling many chemical reactions and biological activities in the water.

Table 2 Physical quality determinands °

Determinand	Measuring Units	Allowable range
Free chlorine	mg/L	≤ 5
Monochloramine	mg/L	≤ 3
Colour	mg/L Pt-Co	≤ 15
Conductivity	mS/m	≤ 170
Taste and odour	–	Inoffensive
Total dissolved solids	mg/L	≤ 1 200
Turbidity	NTU	≤ 1
pH	–	≥ 5 and ≤ 9,7

4.2.2 Chemical properties

4.2.2.1 Inorganic chemicals

Water is abstracted from the natural environment before being treated and distributed, where it gets into contact with a large range of elements and compounds present in air, on the surface of the earth and in soil and rocks. The water may also have come into contact with human activities,

industrial processes or pollution. The most important inorganic chemicals that should be tested for in water distribution systems are listed in Table 3, with their allowable ranges as specified by SANS 241.

4.2.2.2 Organic substances

Various organic compounds found in water can cause water quality problems and concerns. The major groups of concern from

Table 3 Chemical water quality determinands °

Determinand	Units of measure	Allowable values
Nitrate as N	mg/L	≤ 11
Nitrite as N	mg/L	≤ 0,9
Sulphate as SO ₄ ²⁻	mg/L	≤ 250
Fluoride as F ⁻	mg/L	≤ 1,5
Ammonia as N	mg/L	≤ 1,5
Chloride as Cl ⁻	mg/L	≤ 300
Sodium as Na	mg/L	≤ 200
Zinc as Zn	mg/L	≤ 5
Antimony as Sb	µg/L	≤ 20
Arsenic as As	µg/L	≤ 10
Cadmium as Cd	µg/L	≤ 3
Total chromium as Cr	µg/L	≤ 50
Cobalt as Co	µg/L	≤ 500
Copper as Cu	µg/L	≤ 2 000
Cyanide (recoverable) as Cn ⁻	µg/L	≤ 70
Iron as Fe	µg/L	≤ 300
Lead as Pb	µg/L	≤ 10
Manganese as Mn	µg/L	≤ 100
Mercury as Hg	µg/L	≤ 6
Nickel as Ni	µg/L	≤ 70
Selenium as Se	µg/L	≤ 10
Uranium as U	µg/L	≤ 15
Vanadium as V	µg/L	≤ 200
Aluminium as Al	µg/L	≤ 300

SANS 241 are listed in Table 4 and are briefly explained below:

- **Dissolved organic substances** originate from biological activity and are mainly found in surface water. They are mostly harmless, but can include harmful substances such as pesticides. Organic substances can serve as a food source for micro-organisms leading to them growing in distribution systems and causing water quality deterioration.
- **Trihalomethanes** are disinfectant by-products that form when chlorine reacts with organic substances in the water. Some trihalomethanes are potential carcinogens (cancer causing substances), and thus limits are set for trihalomethanes in drinking water.
- **Phenols** are a class of chemical compounds that mostly originate from industrial pollution and may affect the taste of water.

4.2.3 Microbiological properties

Micro-organisms, such as viruses, bacteria and protozoa in water can cause diseases, taste and odour problems and corrosion of concrete and metals in the distribution system. Since it's impossible to routinely check for all possible micro-organisms, tests focus on microbiological indicators that may not be harmful themselves, but indicate that the water is contaminated and thus may also contain other harmful micro-organisms. The main microbiological determinants from SANS 241 are listed in Table 5 and are briefly explained below:

- **Coliforms** are used as an indicator of faecal pollution, and thus the possible presence of micro-organisms that can cause gastro-intestinal and other diseases. Faecal coliforms or Escherichia Coli (E. Coli) are coliforms that are common in the intestinal tracts of animals, and may be tested for separately, or with other coliforms in a total coliforms test.

Table 4 Organic water quality determinands °

Determinand	Units of measure	Allowable values
Total organic carbon as C	mg/L	≤ 10
Trihalomethanes		
- Chloroform	mg/L	≤ 0,3
- Bromoform	mg/L	≤ 0,1
- Dibromochloromethane	mg/L	≤ 0,1
- Bromodichloromethane	mg/L	≤ 0,06
Phenols	µg/L	≤ 10

- **Heterotrophic bacteria** use organic carbon as a nutrient source and provide an indication of general microbiological quality of water.
- **Cytopathogenic viruses** are a group of viruses that cause human diseases such as gastroenteritis, encephalitis, polio, meningitis, hepatitis, respiratory illness and diarrhoea.
- **Protozoan parasites** are present in water as cysts and thus have coverings (like the shell on an egg) that protect them against threats. This covering also protects them against chlorine, which means they can be transmitted through the water distribution system. The two most important protozoan parasites in water distribution are *Giardia* and *Cryptosporidium*, which both cause diarrhoea and vomiting in humans.
- **Somatic coliphages** are viruses that infect *E. coli* and certain related bacteria. Thus they may also be used as indicators of faecal pollution.

4.3 Consequences of a loss in water quality integrity

A loss of water quality integrity may have serious consequences, including the following:

- **Health risks.** The most important potential consequence of a loss of water quality integrity is health problems caused by substances in the water. Water can contain a large range of substances and many of these can be harmful to human health if ingested in high enough quantities. Exposure through the water distribution system may also occur by inhaling water droplets (e.g. in the shower), or through skin contact. Certain substances cause an acute health risk, meaning that a person can get ill from it shortly after contact with the contaminated water. Other substances create a chronic health risk, meaning that the substance will build up in a person's body over time and create health problems after prolonged exposure.

Table 5 Microbiological water quality determinands °

Determinand	Units of measure	Allowable values
Total coliforms	Count per 100 mL	≤ 10
<i>E. coli</i> or faecal coliforms	Count per 100 mL	Should not be present
Heterotrophic plate count	Count per mL	≤ 1 000
Cytopathogenic viruses	Count per 10 L	Should not be present
Protozoan parasites (<i>Cryptosporidium</i> and <i>Giardia</i> species)	Count per 10 L	Should not be present
Somatic coliphages	Count per 10 mL	Should not be present

- **Unacceptable aesthetics.** Water that is perfectly safe to drink may still be unacceptable on aesthetic grounds due to unpleasant taste, odour or colour present in the water.
- **Corrosion.** Certain water characteristics may enhance internal corrosion of metal or concrete pipes, reducing the service life of the pipes.
- **Reduction in system capacity.** Water may contain high concentrations of certain chemicals that build up on the inside of pipes, increasing roughnesses and reducing effective pipe diameters over time.
- **Reduced effectivity of water meters** due to biofilm growth or pieces of biofilm getting stuck in meter mechanisms.

4.4 Causes of a loss of water quality integrity

The causes of a loss of water quality integrity may be placed into two categories: those that allow contaminants from outside the network to enter the system, and processes inside the distribution system that result in water quality changes.

4.4.1 Contamination from external sources

For the water in a distribution system to be contaminated from external sources, three conditions have to be fulfilled:

- The presence of a contaminant outside the network.
- A loss of physical integrity, creating a route for the contaminants to enter

the system.

- A driver that moves the contaminant into the network.

Since it is impossible to control or know processes that occur outside the distribution network, it is safe to assume that all matter from outside the network will be contaminated and thus undesirable.

In most cases the driver for contaminants to enter the system is pressure, which occurs when the pressure inside the system is lower than outside it. This can happen when the pressure in the network drops below atmospheric pressure (i.e. become negative) due to excessive demands or water hammer. Negative pressures mean that groundwater and soil outside the network is sucked into it through cracks and holes.

Another possibility is that water supplied to a private pipe network or pressurised tank is sucked back into the system when the system pressure drops due to operational changes.

Finally, if non-potable water is supplied to an area through a parallel distribution system, an unintentional cross-connection between the two systems can cause non-potable water to enter the distribution system when pressures in the network are lower than in the non-potable system.

Below is a list of the most common instances where contamination from external sources may occur:

- **Intrusion** of contaminated water and soil particles into the pipe through leakage openings when negative pressures occur in the system. Even the best managed water distribution systems

have leaks, and thus negative pressures should always be avoided.

- ***Drowned air valves.*** Bulk pipelines are often equipped with air valves at various points to ensure that air entering the pipe can be vented. Air valves also allow air to enter the pipe when the pipe is drained or when negative water hammer pressures occur. Thus when an air valve chamber fills with water, this potentially polluted water that may be sucked into the system instead of air.
- ***Insufficient backflow protection*** on private systems that store water under pressure, or boost the pressure in their systems through pumps. Backflow prevention devices are installed at certain users to prevent water supplied from being able to return to the distribution system. However, if such devices are missing or malfunction, the water quality in the system may be compromised as a result.
- ***Contamination during construction and repairs.*** When a section of the distribution system is isolated and opened to connect new pipes or repair existing pipes, the system is vulnerable to polluted water, soil and other substances entering it. Thus it is essential that construction crews are well trained to prevent pipes from being contaminated during construction, and that repaired pipes are thoroughly flushed and disinfected before they are reconnected.
- ***Animals or insects*** may enter reservoirs when air vents and access openings are not properly sealed and protected with a fine mesh. Animals may fall in the water and drown, defecate in the water

or bring in other external materials that may pollute the water in the reservoir.

- ***Permeation*** occurs when chemical solvents associated with oil and petrol come into contact with plastic pipes, compromising the physical integrity of the pipe and entering the water. This occurs where plastic pipes are used in areas where fuel or chemicals related to petrol are spilled or leak from storage tanks.
- ***Vandalism or unauthorised access*** by people, particularly at reservoirs, resulting in accidental or even deliberate contamination of the water.

4.4.2 Internal deterioration of water quality

Water may deteriorate inside the distribution network, resulting in a loss of water quality integrity. Internal deterioration may occur the following ways:

- ***Reactions*** with pipe and reservoir materials. Water can corrode or leach constituents from concrete or metal surfaces of pipes, reservoirs and other network components. This may introduce undesirable elements such as lead or copper into the water, create tuberculation or introduce sediments that are suspended into the water when sudden changes in flow occurs.
- ***Advanced water age.*** As water ages, disinfectant by-products such as chlorine continuously reduce in concentration, while the concentration of disinfectant by-products increase. Thus, as a general rule it is desirable to deliver treated water to the consumer in the

shortest possible time, since long retention times provide more opportunities for disinfectant residuals to be depleted and disinfectant by-products to grow to higher concentrations.

- **Unstable water.** Water introduced into the distribution system should be stabilised in the treatment process, meaning that it should neither be corrosive, nor scale forming. Corrosive or aggressive water will tend to accelerate corrosion processes in the network, while scale-forming water will tend to deposit calcium carbonate scale on the surfaces of pipes and reservoirs, but particularly on the elements of water heaters or industrial equipment. Corrosive water tends to have low pH, be soft or have primarily non-carbonate hardness and have a low alkalinity. Conversely, scale-forming water tends to have high pH, be hard with primarily carbonate hardness and have high alkalinity.
- **Biofilm growth.** Pipe surfaces are not sterile, but develop a layer of microbiological activity called a biofilm that attaches to the surface of the pipe and sediments. The ecology of biofilms is still poorly understood, but it is known that they can lead to accelerated chlorine depletion, coliform and other bacterial growth, pipe corrosion and taste and odour problems. Higher chlorine concentrations and lower temperatures inhibit biofilm growth.

4.5 Measuring water quality integrity

Water quality integrity is measured by taking water samples at different points in the network (including the water treatment plant and sources) and measuring the concentrations of disinfectant residuals and other constituents in the samples using standard methods. Complaints from consumers provide another source of information on water quality integrity. Automatic samplers are available that can take samples at given intervals (e.g. every hour) over a period of time. Tools are also available to continuously measure the concentrations of certain constituents in water and signal alarms when critical levels are reached.

Consumer complaints are a valuable source of information on system integrity and should be monitored for indications of a loss of water quality integrity, including reports of smells, odours or dirty water. In addition, data from clinics or hospitals can be used to identify health problems that may be related to water quality.

4.6 Maintaining water quality integrity

This section focuses on generic measure for maintaining water quality integrity that applies to most distribution system components under the headings of design and construction, operation and maintenance. Measures that are specific to particular system components are discussed in Part 2 of the book.

Water quality should not rely on a single system, but should include various barriers,

that facilitate the delivery of high quality water. The multi-barrier water quality system of a distribution system includes various aspects of physical and hydraulic integrity, as well as specific water quality parameters. Examples of barriers include the physical barrier of an intact distribution network, higher pressures in drinking than in recycled water systems, non-return valves on all consumer supplies and maintaining disinfectant residuals.

4.6.1 Design and Construction

A number of design and construction factors are important to ensure that water quality integrity is maintained, including the following:

- **Storage reservoirs** should be sized to ensure that water retention times are not longer than necessary to ensure a reliable supply, fully mixed water in the reservoirs and that dead zones do not develop.
- **Materials** should be selected to ensure that the risk of negatively influencing water quality is minimised, including the risk of permeation and the potential of leaching chemicals into the network water.
- **Dead-end mains** should be avoided as they often cause stagnant water that create water quality problems through a loss of disinfectant residuals and increased sedimentation. Water is wasted when dead-end pipes have to be flushed regularly to remove accumulated sediments.
- **Construction procedures** should ensure that new pipes are properly

stored, cleaned, flushed and disinfected before being used in the system. The installation or rehabilitation of facilities such as storage reservoirs with floating covers must include water quality checks to ensure that water quality is not adversely affected.

- **Sewer pipe placement** should be such that an adequate distance exists between the sewer and water lines to reduce the risk of sewage contaminating groundwater around water pipes.

4.6.2 Operation

The following generic operational measures are important for maintaining water quality integrity:

- **Risk assessment.** SANS241 requires municipalities to assess risks of not maintaining constituent concentrations within the required limits throughout the water supply chain including the bulk supply system and distribution zones up to the point of delivery. The risk assessment should be done at least once per year at the most critical time of the year, and when major changes are made to the system. These risks are grouped according to their potential impact on human health as follows:
 - Acute health impacts.
 - Chronic health impacts of presence of certain organic or radionuclide contaminants.
 - Aesthetic impacts on water.
 - Operational importance.
 - The risk assessment includes the measurement of all the constituents

listed in Table 1 as well as others that may be anticipated. A monitoring programme and corrective and verification measures should be developed based on the risks identified.

- **Routine monitoring.** SANS 241 requires that routine monitoring of certain constituents is conducted on at least a fortnightly basis as specified.
- **Recovery monitoring.** When water quality failures are identified as part of the risk assessment or routine tests, SANS 241 requires corrective action as well as additional monitoring of the affected parameters on a weekly or monthly basis.
- **Receiving water quality.** Water from treatment plant should comply with the water quality standards and stabilised to minimize deterioration in the network, ensuring that water is neither corrosive nor scale-forming, and that organic carbon is minimized. Residual disinfectants should be chosen and applied in such a way that water quality is maintained in the system, while

the risk of disinfectant by-products is minimised.

- **Maintaining disinfectant residuals.** The concentrations of chlorine residuals in the system are affected by the dosing concentrations at the treatment plants, pump scheduling, retention time and booster chlorination practices. A chlorination strategy should be developed to ensure that residuals are maintained within the allowed range up to the point of delivery.
- **Emergency response.** The South African Water Services Act requires municipalities to issue public water quality notices within 12 hours of a confirmation of a drinking water quality failures. If the problem can be dealt with by boiling the water, a Boil Water Notice should be issued. However, if this will not be adequate, a Do Not Use Water Notices should be issued.

Table 6 Minimum routine monitoring frequency of water quality parameters in water distribution systems

Determinand	Test frequency
pH	Fortnightly
Turbidity	Fortnightly
Disinfectant residuals	Fortnightly
E. coli (or faecal coliforms)	Fortnightly but more frequently as population served increases
Heterotrophic plate count	Fortnightly
Treatment chemicals	Fortnightly

4.6.3 Maintenance

The following maintenance measures are required to ensure that water quality integrity is maintained:

- Regular *cleaning and flushing* of pipes and storage facilities to remove built up sediments.
- Proper *disinfection and flushing procedures* should be followed when-

ever a component is installed, replaced or repaired.

- Regular *cleaning of strainers* used upstream of flow meters, control valves and other components.

Additional Reading

Risk and integrity of water distribution systems

- Committee on Public Water Supply Distribution, National Research Council. (2006). *Drinking Water Distribution Systems: Assessing and Reducing Risks*. Washington, D.C.: National Academies Press. The book can be downloaded for free or ordered from http://books.nap.edu/catalog.php?record_id=11728.

Water quality

- The South African water quality guidelines are published in SANS 241 Drinking water, which consists of two parts:
 - SANS 241-1: Part 1: Microbiological, physical, aesthetic and chemical determinands.
 - SANS 241-2: Part 2: Application of SANS 241-1.
- The World Health Organisation's 2008 document "Guidelines for drinking-water quality" provides an excellent resource for water managers in developing countries. It and other WHO guidelines may be downloaded free of charge from www.who.int/water_sanitation_health/dwq/en/.
- The Department of Water Affairs has a website that provide comprehensive information about the their Blue Drop programme and water quality including documents, tools and data on water quality in South African cities and towns. (www.dwaf.gov.za/dir_ws/dwq/r/).
- Assessment of the occurrence and key causes of drinking-water quality failures within nonmetropolitan water supply systems in South Africa, and guidelines for the practical management thereof. By G Mackintosh and U Jack. WRC Report TT373/08.
- Quality of domestic water supplies
 - Vol: I: Assessment Guide. WRC Report no TT 101/98
 - Vol II: Sampling Guide. WRC Report no TT 117/99
 - Vol III: Analysis Guide. WRC Report no TT 129/00
 - Vol IV: Treatment Guide. WRC Report no TT 181/02
 - Volume V: Management Guide. WRC Report no TT 162/01

SYSTEMS FOR MANAGING OPERATION AND MAINTENANCE

5.1 Introduction

Operation and maintenance of water distribution happen in a dynamic and complex environment with many influencing factors and competing objectives. Thus it is necessary to put systems in place to benchmark and guide operation and maintenance actions to have optimal impact. This chapter presents three systems that are essential for any operation and maintenance plan:

- Water balance
- Asset management
- Water safety plan

5.2 Water balance'

The International Water Association (IWA) has been leading efforts to categorise water in the municipal system, and does this through the water balance shown in Figure 7.

The annual volume used in each of the

water balance categories is estimated and entered into the relevant cells. It is important to understand exactly what each of the terms in the water balance means. Most are obvious from their names, but these may not be:

- **Authorized Consumption** is the volume of water delivered to registered customers of the water supplier and others who are authorised to do so for domestic, commercial and industrial purposes, whether these users are metered or not. It includes water exported and water used for fire fighting, flushing, street cleaning, etc.
- **Water Losses** are defined as the *System Input Volume* minus *Authorised Consumption*. *Water Losses* consist of *Real Losses* and *Apparent Losses*.
- **Real Losses** consist of physical water losses from the system up to the point of customer meters. It includes water lost through all types of leaks, bursts and overflows.

System input volume	Authorised consumption	Billed authorised consumption	Billed metered consumption (including water exported)	Revenue water	
			Billed unmetered consumption		
		Unbilled authorised consumption	Unbilled metered consumption	Non-revenue water	
			Unbilled unmetered consumption		
	Water losses	Apparent losses			Unauthorised consumption
					Metering inaccuracies
		Real losses			Leakage on transmission and/or distribution mains
					Leakage and overflows at utility's storage tanks
	Leakage on service connections up to point of customer metering				

Figure 7 The IWA water balance

- **Apparent Losses** consist of components that seem like losses to the municipality, but are actually consumed. *Apparent losses* are mainly made up by *Unauthorised consumption* (theft or illegal use) and *Metering inaccuracies*, but can also include administrative errors.
- **Non-Revenue Water** is the difference between the *System input volume* and *Billed Authorised consumption*.

Standard methods have been developed to estimate the different components of the water balance, and should be calculated and analysed on an annual basis. Municipalities should operate and maintain their systems in such a way that water losses are minimised.

5.2.1 Real losses

A comparison of the readings on bulk transfer, zone, DMA and consumer water meters can be used to estimate real losses in different parts of the network. This is done

by either comparing the volume through a bulk meter with the sum of the volumes through all the consumer meters served by it or by analysing the minimum night flow in a DMA. Leak detection teams and pipe replacement programmes can then be focussed on the most problematic areas.

Leaks in distribution pipes are categorised as bursts or background leaks. Bursts are large enough to be detected through active leak detection efforts, while background leaks are too small to be detected and thus remain in place.

Real losses are reduced through four actions as shown in Figure 8:

- **Active leakage control**, which includes various methods to actively find and repair leaks in the system. Various leak detection devices exist, some based on listening for the sound leaks make from outside the network, while others place a sensor inside the pipe. Advanced DMA meter data analysis techniques

Steps for Calculating Non-Revenue Water and Water Losses^(adapted from r)

Water losses and non-revenue water are estimated based on the IWA Water Balance in the way described below. In each case, the value determined for a component is entered into the water balance table. Values are split up in the table so that columns will always add up to the same totals. For example, the values in the *Apparent Losses* and *Real Losses* cells should add up to the value in the *Water Losses* cell.

Step 1: Estimate the *system input volume*.

Step 2: Estimate the *billed metered consumption* and *billed unmetered consumption*. Enter the appropriate totals in *authorised consumption* and *revenue water*.

Step 3: Calculate the volume of *non-revenue water* as the *system input volume* minus *revenue water*.

Step 4: Estimate *unbilled metered consumption*

and *unbilled unmetered consumption*. Enter their sum in *unbilled authorised consumption*.

Step 5: Add *billed authorised consumption* and *unbilled authorised consumption* to give *authorised consumption*.

Step 6: Calculate *water losses* as the difference between *system input volume* and *authorised consumption*.

Step 7: Assess components of *unauthorised consumption* and *metering inaccuracies* and add these to get *apparent losses*.

Step 8: Calculate *real losses* as *water losses* minus *apparent losses*.

Step 9: Assess the components of real losses using methods such as minimum night flow analysis, burst frequency - flow rate - duration calculations, modelling, etc. Add these components and cross-check with *real losses*.

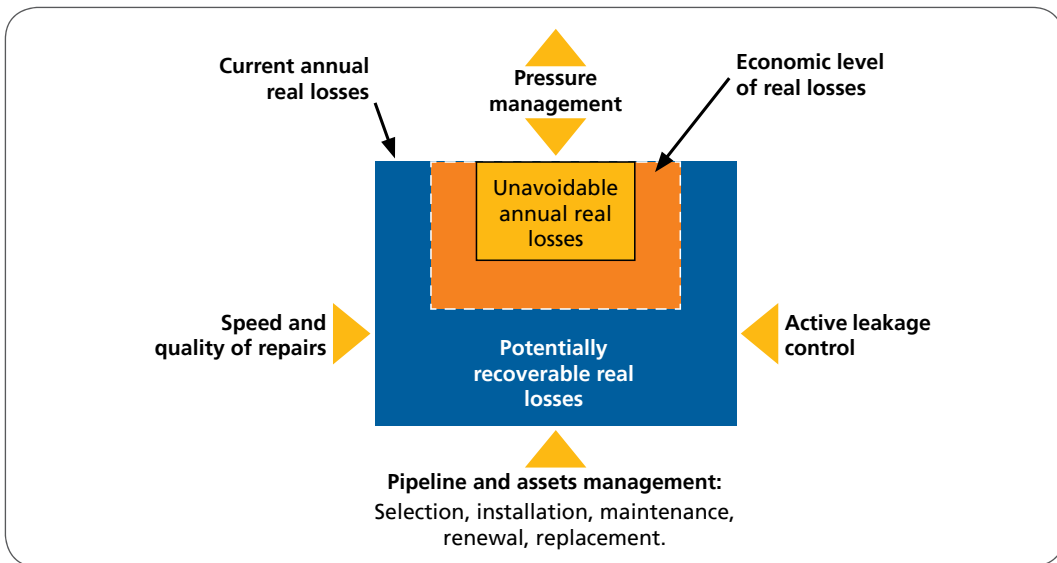

Figure 8 Components of real loss management (adapted from www.leakssuite.com)

are becoming available that detect new leaks as they occur in a DMA.

- **Pressure management** refers to the practice of maintaining pressures in the system as close as possible to the minimum required levels. Pressure management has been shown to have various advantages including lower failure rates, longer pipe service lives and lower water losses and wastage.
- **Speed and quality of repairs** to ensure that leaks are stopped as quickly as possible and do not reoccur.
- **Pipeline renewal** is the process of refurbishing or replacing pipes that present the greatest risk to disrupting service or increasing losses.

5.2.2 Benchmarking system leakage

It is not possible to completely eradicate leakage in a distribution system. To provide a measure of the lowest levels of losses possible to achieve in a distribution system the concept of unavoidable annual real losses (UARL) was developed^k. To calculate the UARL of a system, the following formula is used:

$$\text{UARL (litres/day)} = (18 \times L_m + N_s \times (0.8 + 25 \times L_p / 1\ 000)) \times h$$

Where

- L_m is the length of distribution pipes in the system, measured in kilometres.
- N_s is the number of service connections.
- L_p is the average length of service pipe between property boundary and the consumer meter (measured in metres).

This measure only refers to cases where the consumer meter is inside the property boundary. If the consumer meter outside the property boundary, L_p is equal to zero.

- h is the average pressure head in the system (measured in metres).

Once the UARL is estimated, the Infrastructure Leakage Index (ILI) is calculated as the ratio of the current annual real losses (CARL) to the UARL, or

$$ILI = \frac{CARL}{UARL}$$

This means that an ILI of one is lowest that any system can practically achieve. Note that the UARL is lower than the economic level of leakage, where the cost reducing leakage is higher the savings achieved (see Figure 8).

Finally the ILI can be used to quantify improvements in loss management and benchmark a municipality against others.

Table 7 provides a classification for distribution systems based on their ILIs and Table 8 recommends water loss interventions based on the classification.

5.3 Asset management

5.3.1 Introduction

Operation and Maintenance of water distribution systems are not done in isolation, but are integral to the much wider field of municipal asset management, often called Infrastructure Asset Management (IAM) or Infrastructure Management Systems (IMS).

The wider water services sector in South Africa is responsible for infrastructure assets with a replacement value of approximately R200 billion that is essential for healthy communities and economic growth.

An assessment of the state of water services infrastructure in South Africa by the Department of Water Affairs (DWA) indicated severe problems that needed to be addressed urgently. It was realised that municipalities generally don't manage their assets effectively due to growing demands in the quantity, capacity and quality of infrastructure services, the aging and deterioration of existing infrastructure, new legislative requirements and the drive towards improved efficiency ^c.

In response to the problems identified,

DWA developed a National Water Services IAM strategy with support of a number of important stakeholders. DWA is leading efforts to implement this policy at water service providers throughout the country. Thus the Government's IAM strategy is part of their proactive approach to ensure effective operation and proper maintenance, aimed at ensuring optimal utility from public investments and reliable and sustainable service delivery ^s. The Water Services Act requires every municipality to have an asset management plan.

In simple terms, asset management is a process that is followed to buy or create, maintain, replace and dispose of assets in a cost effective way, so that the delivery of services within the Municipal area of jurisdiction, can continue in the long term^b.

Table 7 Classification of distribution systems based on ILI (from www.leakssuite.com)

Developing Countries	Developed Countries	BAND	General description of Real Loss management Performance Categories
ILI range	ILI range		
Less than 4	Less than 2	A	Further loss reduction may be uneconomical unless there are shortages; careful analysis needed to identify cost-effective improvement
4 to < 8	2 to < 4	B	Potential for marked improvements; consider pressure management, better active leakage control practises, and better network maintenance
8 to < 16	4 to < 8	C	Poor leakage record; tolerable only if water is plentiful and cheap; even then, analyse level and nature of leakage and intensify leakage reduction efforts
16 or more	8 or more	D	Very inefficient use of resources; leakage reduction programmes imperative and high priority

Table 8 Recommended leak management strategies management (from www.leakssuite.com)

Recommended loss management interventions	A	B	C	D
Investigate pressure management options	Yes	Yes	Yes	
Investigate speed and quality of repairs	Yes	Yes	Yes	
Check economic intervention frequently	Yes	Yes		
Introduce/improve active leakage control	Yes	Yes	Yes	
Identify options for improved maintenance		Yes	Yes	
Assess Economic Leakage Level	Yes	Yes		
Review burst frequencies		Yes	Yes	
Review asset management policy		Yes	Yes	Yes
Deal with deficiencies in manpower, training and communications			Yes	Yes
5-year plan to achieve next lowest band			Yes	Yes
Fundamental peer review of all activities				Yes

Example of water loss benchmarking

A municipality has a water distribution system with 200 km of water mains and 10 000 service connections. The average pressure head in the system is 50 m. On average, water meters in the system are installed 2 m inside property boundaries. Real losses in the system are estimated at 3 000 MI/year. Evaluate the level of real losses in the distribution system and recommend interventions to address the problem.

Step 1: Calculate the Unavoidable Annual Real Leakage [UARL]

$$\text{UARL} = (18 \times 200 + 10\,000 \times (0.8 + 25 \times 2/1\,000)) \times 50 = 605\,000 \text{ litres/day or } 221 \text{ MI/a}$$

Step 2: Calculate the Infrastructure Leakage Index (ILI)

$$\text{ILI} = 3\,000/221 = 13.6, \text{ say } 14.$$

Step 3: Benchmark the municipality based on its ILI

From Table 7 for a developing country: B and C, which means poor.

Step 4: Identify potential loss management interventions

- Implement pressure management
- Improve speed and quality of repairs
- Introduce active leakage control (actively look for leaks)
- Improve maintenance practices
- Identify and replace pipes with the highest burst frequencies
- Improve asset management practices
- Improve available manpower, train staff and improve leak reporting system
- Put in place a five-year plan to move to Band B (ILI below 8)

The Institute of Municipal Engineering of Southern Africa (IMESA) also developed an asset management system by adapting a system widely used in Australasia to South African conditions and facilitating software for the implementation of their system available free of charge to municipalities.

While the DWA and IMESA asset management systems differ in their approaches and steps, they have a great deal in common and aim to achieve the same essential objectives. The two systems are compared in Table 9. Three phases can be identified in the development of an asset management plan:

- Technical assessment of the system
- Financial assessment of the system
- Implementation of appropriate asset management practices

The key ingredients of an asset management plan are as follows:

- A description of the **scope** of the assets and services the municipality is responsible for.
- An **asset register** containing data on all the assets owned by the municipality.
- **Financial** requirements for developing and maintaining the system.

Table 9 Steps in the development of an asset management plans as proposed by DWA and IMESA.

Phase	DWA IAM		Steps in IMESA IAM
	Step	Questions answered	
Technical assessment	1. Asset register	What do you own? Where is it located? What is it worth?	1. Asset Register
	2. Condition assessment	What is its condition? What is critical? What is its service life?	2. Condition assessment 3. Remaining Useful Life
Financial assessment	3. Current and future needs	Service Level Requirements Investment Requirements Funding Requirements	5. Levels of service and demand
	4. Costing analysis	Depreciation of Assets Life time Cycle Costs Risk Analysis	4. Valuation and life cycle cost 6. Business risk exposure
Asset management practices	5. Operational plan	Organisational Development Plan Training & Development Emergency response	7. Operation and maintenance plans 8. Capital investment validation 9. Future expenditure model and funding
	6. Maintenance plan	Current Practices Gap Analysis Routine and long term maintenance	10. Asset management plan to suit budget

- The *practices* that must be put in place to make the asset management successful.
- The *people* that manage and implement the asset management plan.

In developing an asset management plan the following approach is recommended⁸: start with the basics, and get them right. Use an incremental approach, but do not proceed to the next level until the basics are right. Address the weakest links in the system first, and then the next weakest once the first has been improved. Where there is strength, support it, and build on it.

5.3.2 Technical assessment

The technical assessment consists of identifying all assets in the municipality and assessing their condition. Assets include both movable (vehicles, furniture, equipment, etc.) and immovable (reservoirs, pipelines, buildings, etc.) assets. Each asset should be identified using various sources of information such as as-built drawings, reports and site inspections. This can be a tedious and long process, but is very important to do well.

The identified assets are then placed in a hierarchy consisting of five levels:

- System (e.g. water services, roads, electricity)
- Sub system (e.g. water or sewerage)
- Facility (e.g. water treatment plant)
- Asset (e.g. pump station or reservoir)
- Component (e.g. a valve, pump or flow meter)

Each asset is then given a unique number that preferably contains information about

the asset, such as the asset hierarchy it belongs to, coordinates and size. The assets are then listed in an asset register that contains information on things like the asset number, description, material, year constructed, photograph, condition and replacement value.

The second part of the technical assessment is an assessment of the condition of each asset. This can be done by scoring each asset according to three scales:

- The condition of the asset (see Table 10)
- The extent of defects in the asset (see Table 11)
- The relevance of defects in the asset in relation to it performing in its intended function or impact on safety (see Table 12).

5.3.3 Financial assessment

Financial assessment includes an analysis of the needs and costs of managing the assets. As part of this process, it is important to determine the value of assets owned by the municipality. The following aspects need to be considered:

- The *value* of the asset, which may be the replacement value (i.e. how much would it cost to replace the asset with a new one) or the current value (what is it currently worth).
- The *useful life* of the asset, which is the period that the asset can fulfil its intended function before it has to be replaced. The useful life of an asset depends on many factors, such as how well it is maintained, the climate, how often it is used, etc.

Table 10 Scale for asset condition

Degree	Detailed Description
0	No visible defects, not applicable
1	Generally good condition, no real defects
2	Fair condition, still performing adequately but could get worse if neglected
3	Poor condition, not performing its function properly or in such a state that it will soon become a significant problem
4	Very poor condition, not performing its function and will soon become a major problem

Table 11 Scale for the extent of defects in the asset

Extent	Detailed Description
0	Unable to inspect, underground or no access
1	Local, at one or 2 locations
2	Intermittent, at more locations than local
3	Almost general, at several widely spread locations
4	General, occurring extensively at all locations

Table 12 Scale for the relevance of defects for safety of the ability of the asset to fulfil its intended function

Relevance	Detailed Description
0	Not relevant
1	Minimum, very little effect on either function or safety
2	Minor, unlikely to have serious consequences
3	Major, could threaten structural integrity and / or safety of people
4	Maximum, could cause structural collapse and / or severe hazard

- Assets *depreciate* in value over their life spans. Typically, the value of the asset at the end of its service life (or its residual value) is estimated, and its value is then determined by a linear depreciation over time.

5.3.4 Asset management practices^b

Asset management practices consist of developing operational and maintenance

plans for the assets. A starting point is to identify the type and frequency of maintenance that is required for each asset. Based on this information, a maintenance schedule can be developed and used to ensure that other systems are in place to support the required planned and unplanned maintenance, such as the right items in the stores and plans for emergency maintenance. The manufacturer's recommendations are very important for any asset and should be

incorporated in operational and maintenance plans.

Asset management practices also include the appointment and training of competent staff that can run the different aspects of the operation and maintenance plans.

The maintenance plan should cover every component of every asset in every facility and system in the municipality. It is a good idea to start with a maintenance plan for the following year, and then cover at least five years into the future. The plan should be reviewed on an annual basis.

All maintenance activities must be incorporated into the maintenance staff work schedules so that the work is done on time and as required. All activities must be done according to an approved in the budget, and monitored accordingly.

Finally, monitoring the work that is done and keeping reports of work completed is critical to maximise the effectiveness of the maintenance and allow trends in asset performance to be analysed to make preventative maintenance practices more appropriate..

5.4 Water safety plan^x

Municipalities have a responsibility to ensure that water delivered to consumers comply with the relevant standards. Failure to do this may cause illness and even death as clearly illustrated by well publicised water quality failures in Bloemhof (2006 and 2014) and Delmas (2005).

The water safety plan (WSP) concept was developed as a water quality assurance programme based on the multi-barrier con-

cept. The multiple barrier concept refers to actions at all stages in the water purification and distribution process to ensure that consumers are supplied with water of adequate quality. This includes the protection of water sources, the different water treatment processes, the water distribution system and even the handling of water within households.

A WSP provides an organised and structured system to minimize the risk of water quality failures due to oversight or management lapse. It also includes contingency plans to respond to system failures or hazardous events.

A Water Safety Plan has three key steps as shown in Table 13:

- **System assessment** to determine the intended use of water and whether the water supply system can deliver the required water quality.
- **Risk assessment** to identify threats to water quality, events that may result in water quality failures and the potential risk to consumers.
- **Risk management** by putting in place control measures, monitoring, management procedures, support programmes, and documentation and verification processes.

The water distribution system forms a single, but important link in the water supply chain. However, a water safety plan cannot be developed for the distribution system in isolation of other components. This book will assist with identifying the risks and operation and maintenance measures for distribution systems that are relevant to the development of a water safety plan.

Table 13 Steps for setting up a Water Safety Plan^x

STEP ONE	STEP TWO	STEP THREE
Water supply system assessment	Risk assessment	Risk management
<ul style="list-style-type: none"> • Team assembled to conduct WSP • Intended use of water established 	<ul style="list-style-type: none"> • Hazard identification (biological, chemical, physical or radiological) from source to consumer • Hazardous event identification • Risk of hazard causing harm to population 	<ul style="list-style-type: none"> • Control measures applied • Operational monitoring • Management procedures (corrective actions and incident/emergency response) • Supporting programmes • Record keeping and documentation • Validation and verification

Additional Reading

Asset management

- DWAF (2011), Water services infrastructure asset management strategy (WSIAM), Water services: policy and strategy, Department of Water Affairs, Pretoria, South Africa. www.dwaf.gov.za.
- Bannister, M. (2012) Asset management plan – 'getting started', Department of Water Affairs, Pretoria
- Infraguide (2003) water – developing a water distribution system renewal plan, National guide to sustainable municipal infrastructure, NRC, Canada
- IPWEA (2011) International infrastructure management manual, International version, Institute of public works engineering Australasia
- Development of a toolkit for strategic asset management by Peter Dunn, Ronnie McKenzie, Caryn Seago. WRC Report no TT 413/09.

Water losses

- Couvelis, F.A., Van Zyl, J.E. (2012) Apparent water losses related to municipal metering in South Africa, Water Research Commission, Pretoria
- Aqualite Water Balance Software – User Guide by RS McKenzie. WRC Report no TT 315/07.
- PRESMAC: Development of a pragmatic approach to evaluate the potential savings from pressure management in potable water distribution systems in South Africa. (Presmac User Guide Version 1.1) by R McKenzie R and A Lambert. WRC Report No: TT 152/01.
- Development of a simple and pragmatic approach to benchmark real losses in potable water distribution systems in South Africa: BENCHLEAK by Ronnie McKenzie and Allan Lambert. WRC Report No: TT 159/01.

- Development of a Windows based package for assessing appropriate levels of active leakage control in potable water distribution systems: ECONOLEAK by Ronnie McKenzie. WRC Report No: TT 169/02
- Benchmarking of leakage from water reticulation systems in South Africa by RS McKenzie and C Seago. WRC Report No: TT 244/05
- An assessment of non-revenue water in South Africa by CJ Seago and RS McKenzie, WRC Report No: TT 300/07

Water safety plans

- Thompson, P., Majam, S. (2009) The development of a generic water safety plan for small community water supply, Report No. TT 415/09, Water Research Commission.
- WHO (2005) Water safety plans - Managing drinking-water quality from catchment to consumer, World Health Organisation. Available from www.who.int/water_sanitation_health/

6.1 Introduction

The vast majority of a water distribution system consists of pipes and couplings to link them to each other in different configurations. Bulk water suppliers and municipalities invest considerably more in the pipe network than in all other water assets combined, and thus it is important that pipes are operated within their limits and maintained to ensure that their service lives are maximised.

Various different pipe, lining and jointing materials have been used over the last century, and since pipes sometimes stay in service for fifty to a hundred years, it is likely that different pipe materials will be present in a given distribution system.

This chapter discusses the most common types of joints and pipe materials used in water distribution systems. This is followed by a discussion of the ways pipes deteriorate and/or fail. Finally, operation and maintenance of pipes are discussed in three sec-

tions: design and construction requirements that facilitate operation and maintenance, operation requirements and maintenance requirements.

6.2 Joint types

Various types of joints are available to connect pipes to each other. The type of joint used is mostly determined by the pipe material used, but also by other requirements such as the ability to handle tension forces, toleration of small deflections and ease of use in the field. The most common types of joints are listed below and illustrated in Figure 9:

- In *spigot and socket* (or *bell and spigot*) joints, one end of a pipe section (the bell) is enlarged and provided with a rubber seal, while the other end (the spigot) is left unchanged. To join two pipes, the spigot of one pipe is pushed into the bell of the other pipe to create a watertight seal.

- **Butt fusion** jointing is used to connect HDPE pipes: the ends of both pipes are heated and then pressed together at a prescribed pressure to create a bond. The quality of workmanship in butt fusion jointing is very important to ensure a strong and lasting joint.
- **Electrofusion** is an alternative jointing method for HDPE pipes that employs special collars with built-in heating coils. The ends of the pipes are cleaned and their outer layers removed using a

special scraping tool to expose virgin material. The electrofusion collar is then placed over the pipe ends and an electrical current applied to the heating coil. The heat melts the material of the collar and pipe together. Quality control is critical and it is important that pipe ends are perfectly round and clean, that the pipes are restrained throughout the fusion process and that joints are allowed to cool down fully before the restraints are removed.

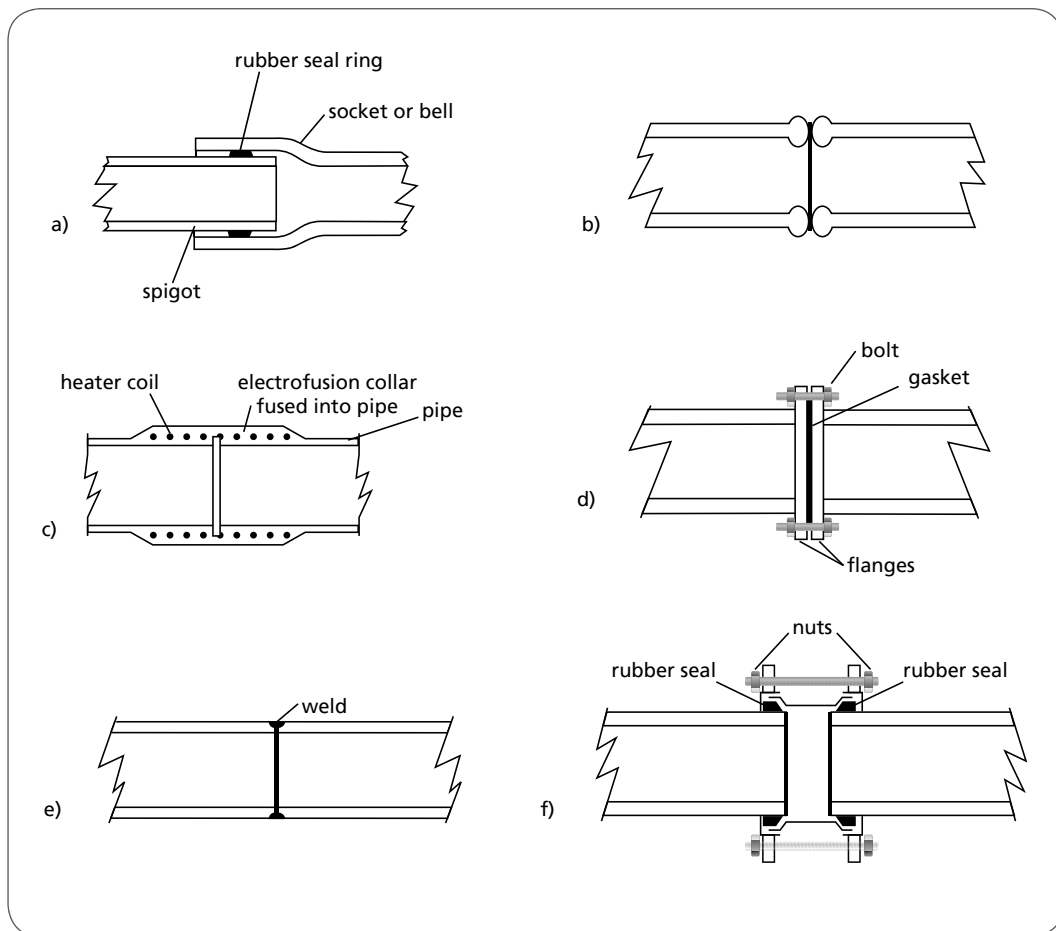

Figure 9 Common types of pipe joints: a) spigot and socket; b) butt welded; c) electrofusion; d) flanged; e) welded; f) mechanical coupling.

- **Flanged** joints consist of both pipes ending in flanges with holes allowing them to be bolted together. A gasket is fitted between the two flanges to ensure a watertight seal.
- Large diameter steel pipes may be joined by **welding** them together in the field. Quality control is critical to ensure that welds are done properly.
- Flexible **mechanical couplings** that compress sealing rings when their bolts are tightened. These couplings can be used to join the same or different types of pipe with plain ends. It is possible to leave a gap between the pipes being joined, which is useful in valve chambers or pump stations where this gap allows components to be easily disassembled and reassembled.

6.3 Pipe materials

Commonly used pipe materials in water distribution systems are briefly discussed in this section from the earliest to the most modern pipe materials:

- **Cast iron** is one of the earliest pipe materials and is still found in older distribution systems. Earliest versions were cast in pits, while later pipes were centrifugally cast. Cast iron has much better corrosion resistance than ductile iron and steel, and was often used without any coating or lining. Spigot and socket joints were mostly used, although flanged joints are also found. Early cast iron pipe joints were sealed with lead, which was later replaced with leadite and then with rubber. When unlined cast iron pipes react
- with water, tubercles may form that can severely restrict flow through the pipe. Disadvantages include that pipe sections are heavy and difficult to handle, that wrapping and corrosion protection is required (especially in corrosive soils) and that stray currents may accelerate corrosion.
- **Ductile iron** pipes replaced cast iron around the middle of the 20th century and are often lined with cement mortar or bitumen. Bitumen and bitumen tape are commonly used as coating. Spigot and socket joints with rubber seals are generally used. Ductile iron pipes have relatively good corrosion resistance and can handle water hammer pressures and soil loads due to its high strength. Disadvantages are the same as for cast iron pipes.
 - **Steel** pipes also came into use from about the middle of the 20th century and are still used today for large diameter pipes and high pressure applications due to its high strength. Steel pipes are susceptible to corrosion and thus need to be protected from the environment both on the inside and outside of the pipe. Cement mortar, bitumen, epoxy and hot-dipped galvanising are used for linings. Coatings may use the same materials, as well as wrapping applied on site to seal the outside of the pipe. Bell and spigot joints with rubber seals, mechanical couplings and flanged couplings are commonly used. Welding can be used to join pipes of 600 mm diameter and larger. Steel pipes are not brittle and thus can deflect without breaking. They are lighter than ductile iron pipes, are resistant to shock loads (such as water hammer) and can

be welded to form any diameter of pipe. Steel pipes are easy to modify and leaks can be repaired by welding them closed or welding a section of steel over the leak. Disadvantages include poor corrosion resistance, requiring the use of linings, coatings and cathodic protection. Stray currents may accelerate corrosion. Welding done in the field requires special equipment and training. Thin walled large diameter pipes rely on soil support to handle external loads. In small diameters, steel pipes become expensive and cannot compete with other materials.

- **Asbestos cement (AC)** pipes became popular in smaller diameters from the 1960s and were used until the 1990s. Fears about the potential health risks of asbestos and the introduction of plastic pipes resulted in asbestos cement not being used for new pipes anymore. However, most municipalities have significant quantities of AC pipes in use and studies have not linked water supplied through AC pipes with increased health risks. AC pipe is normally bitumen lined. Since it is a brittle material, good bedding and continuous support is essential. Insufficient support, point loads or soil movements can lead to the pipe cracking. Joints are typically push-on with rubber gaskets using a short coupling piece. Some connectors, such as twin-gasket couplings, are made out of AC, while others are made out of cast iron. AC pipes are lightweight and low cost compared to metal, but are susceptible to corrosion by soft waters, acids and sulphates. Mechanical joints may not work on AC pipes unless the ends are reamed to provide a smooth

surface. Special care should be taken when handling or cutting AC pipes to ensure that dust from AC pipes is not inhaled.

- **Polyvinyl Chloride (PVC)** is presently the most commonly used pipe in municipal water supply systems. Variations of PVC pipe include the commonly used unplasticised PVC (uPVC), but oriented PVC (oPVC) and modified PVC (mPVC) are also available. In oPVC pipes, molecules are oriented to provide greater strength in certain directions, while mPVC is able to better handle impacts without brittle fracture. uPVC pipes are lightweight and easy to handle, easy to joint and resistant to corrosion. Joints consist of a spigot and socket with a rubber ring seal. The seal is tightened by water pressure, and thus may be more likely to leak at low than at high pressures. PVC pipes and fittings should not be exposed to direct sunlight for long periods as this discolours the material and makes it brittle, and thus unsuitable for use in water distribution. PVC pipes should be stored in covered racks with all pipes laid flat and parallel. Socketed pipes should be stacked with socket and spigot ends alternating to eliminate sagging or distortion of the pipe. PVC pipes require good backfill support, have limited resistance to cyclic loading and susceptible to impact loads, point loads and permeation.
- **High density polyethylene (HDPE)** is another material that is commonly used today in water distribution systems. Unlike PVC, it is flexible, which means that it can be transported in rolls and used in trenchless installations where

it is pulled through an existing pipe to replace it. It is lightweight, resistant to cracking and has many of the benefits of PVC piping. However, it is not damaged by direct sunlight and can be used in above-ground applications. Since it is supplied in long lengths, fewer joints are required. Thermal butt-fusion or electrofusion joints are generally used, but these joints are susceptible to failure if not done perfectly - something that is difficult to achieve in the field. The flexibility of HDPE makes it popular for trenchless technology installations.

- **Glass reinforced plastic (GRP)** is a composite material that uses glass fibres embedded in a thermosetting resin, often in combination with other materials to give it the desired properties. It is light weight and highly resistant to corrosion. Disadvantages include susceptibility to impact damage, importance of properly prepared bedding and blanket to provide support, susceptibility to permeation and the difficulty of doing repairs in the field.



Figure 10 Samples of different pipe materials: a) flanged cast iron pipe showing corrosion tubercles; b) steel pipe with protective wrapping; c) steel pipe with cement mortar lining; d) AC pipes; e) GRP pipe

6.4 Deterioration and common failure patterns

Numerous factors can cause pipe performance to deteriorate or lead to failure. The main causes can be classified as follows:

- **Loads on a pipe exceeding its strength** can result from soil movements, traffic or other surface loads, water hammer, construction activities and natural disasters.
- In some cases, **pipe strength deteriorates** over time due to factors such as:
 - Plastic materials are known to undergo **visco-elastic creep** deformation, which means that they (like most other materials) have a limited service life. Plastic pipes will take much longer to fail at low than at high pressures relative to their design loads and new plastic pipes are designed with large safety factors to compensate for visco-elastic creep.
 - **Corrosion** removes material from metal pipes, thus creating leaks and reducing pipe wall thickness (and thus strength) over time.
 - **Direct sunlight** deteriorates PVC pipes.
 - **Exposure to chemicals** related to fuel degrades plastic pipes, leading to permeation.
- **Poor construction methods** may result in a well designed pipe failing due to insufficient bedding or blanket support (e.g. poor materials, voids in the bedding material or insufficient compaction), insufficient cover or sharp stones or other materials pushing against the pipe.

Causes of failure vary for different pipe materials and are related to the way in which the pipe fails. The main causes of failure and typical failure modes are summarised in Table 14 and illustrated in Figure 11.

Table 14 Main causes of failure and typical failure modes of different pipe materials ^f

Pipe material	Problems causing failure	Typical failure modes
Cast Iron	Internal corrosion Joint misalignment Joint seal damaged, obstructed or misaligned External corrosion Manufacturing flaws Shear failures due to inadequate bedding or external loads.	Circumferential cracks ^{s,m} Split bell ^{s,m} Corrosion through holes ^{s,m,l} Longitudinal breaks ^{m,l} Spiral cracks ^m Blowout ^m Bell shear ^l
Ductile Iron	Internal corrosion Joint misalignment Joint seal damaged, obstructed or misaligned External corrosion Manufacturing flaws Shear failures due to inadequate bedding or external loads.	Corrosion through holes

Pipe material	Problems causing failure	Typical failure modes
Steel	Internal corrosion External corrosion Excessive deflection Joint seal damaged, obstructed or misaligned Imperfections in welded joints	Corrosion through holes Large diameter pipes are susceptible to collapse
Asbestos cement	Internal corrosion Cracks Excessive deflection Joint misalignment Joint seal damaged, obstructed or misaligned Handling damage (especially small diameters) Insufficient bedding support Difficult to find non-metallic pipe underground Shear failures due to inadequate bedding or external loads.	Circumferential breaks, Pipe degradation in aggressive water Longitudinal splits
PVC	Excessive deflection Joint misalignment Joint seal damaged, obstructed or misaligned Exposure to sunlight. Excessive internal working or water hammer pressures Exposure to solvents Difficult to find non-metallic pipe underground	Longitudinal breaks due to excessive mechanical stress
HDPE	Excessive deflection Joint misalignment Welding jointing weakness due to misalignment, incorrect welding procedure or impurities Excessive internal working or water hammer pressures Exposure to solvents Difficult to find non-metallic pipe underground	Joint imperfections Mechanical degradation from improper installation methods

Notes: ^s small diameter (< 375 mm); ^m medium diameter (375 – 500 mm); ^l large diameter (> 500 mm)

6.5 Operation and maintenance of pipes

6.5.1 Design and Construction

A number of requirements in the selection and design of pipes are important for operation and maintenance, including the following:

- Ensure *pipe classes adequate* for operating, static and water hammer pressures.
- Don't use plastic pipes where a *risk of permeation* damage exists.
- Only use SABS or ISO compliant pipes that are manufactured using *strict quality control* measures especially for plastic pipes. Note that unscrupulous

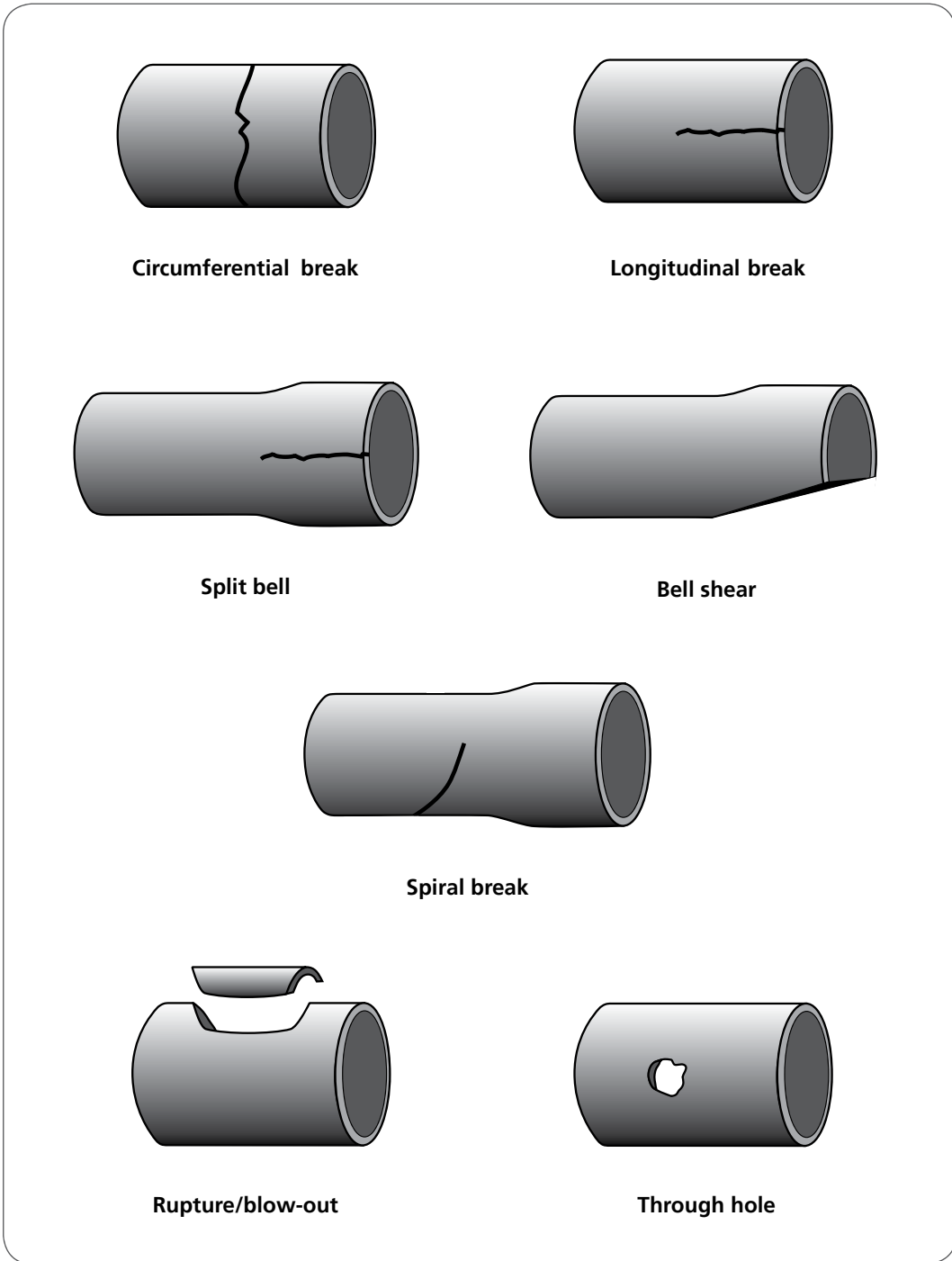

Figure 11 Structural failure modes of water pipes

manufacturers sometimes claim that their pipes have the SABS or other quality mark without this being the case. It is always recommended to verify quality marks directly with the testing organisation.

- Particular care should be taken in ensuring that pipes can withstand high stresses caused by **external threats** conditions such as heaving soils, high external loads and sink holes.
- It is important that a municipality is comfortable with their ability to maintain and repair a new pipe material before it is used.

Construction requirements that may affect operation and maintenance include the following:

- **Transport, storage and handling** of pipes should be done carefully and in accordance with manufacturer specifications.
- **Bedding and blanket** should consist of selected granular material compacted in layers. The bedding depth should be at least 100 mm or one sixths of the pipe diameter, whichever is greater.
- **Adequate cover** should be provided to ensure pipes are not damaged by activities above ground. Cover material should be placed and compacted in layers. Cover above the pipe should be at least 600 mm under normal conditions, and at least 800 mm at road crossings.
- Pipes should be **located in road reserves** and passing them under roads or through private property should be avoided.

- Pipes should be supported with concrete **thrust blocks** pushing against in-situ soil at bends, junctions and end caps.
- Pipes should be **stored on site** in a way that will not damage or deteriorate the pipes. When pipes with socket and **spigot joints are stacked**, the spigot ends should alternate between rows and protrude from the rest of the stack. In other words, the spigots should not carry any weight.
- PVC and polycorp pipes should not be stored or installed in **direct sunlight**.

6.5.2 Operation

Operational requirements of pipes include the following:

- The **rated operating pressure** of a pipe should never be exceeded even for short periods such as under water hammer conditions.
- **Negative pressures** should be avoided under all operating conditions.

6.5.3 Maintenance

Maintenance requirements of pipes include the following:

- **Check for pipe leaks** through appropriate active leak detection methods at regular intervals.
- **Flush pipes** to remove accumulated sediments, especially those pipes where low velocities are likely to occur such as dead-end pipes.

Models are available to determine when



Figure 12 Examples of failed pipes in water distribution systems: a) longitudinal split in a steel pipe; b) corrosion holes in a steel pipe; c) longitudinal crack ending in a bell shape in an AC pipe; d) erosion damage due to soil agitation on the outside of an AC pipe with a longitudinal crack; e) damage due to improper storage of PVC pipes; f) damage due to PVC pipes improperly stored against unprotected wooden poles; g) black discolouring indicating permanent damage to the structure of PVC pipes improperly stored in direct sunlight; h) damage to PVC pipes due to negative pressures; i) poorly done electrofusion weld on an HDPE pipe (note the melted plastic that flowed out of the joint).

a pipe should be replaced, i.e. when the cost of replacing it is lower than the cost of on-going maintenance. A rule of thumb of three failures in the life of a pipe section is sometimes used as an indication that this point has been reached and the pipe should be replaced.

Figure 12 provides some examples of failed pipes in water distribution systems.

6.6 Common operation and maintenance tasks

6.6.1 Locating pipes

Changes in pipe direction, including bends and T-junctions, should be marked with pipe markers so that it is possible to effectively locate a pipe for maintenance or expansion purposes. Valve boxes and hydrants may also be useful markers for the location of a pipe. In addition, as-built drawings should accurately indicate the location of pipes and other components.

Where the above methods are not available, pipe location techniques may be useful to avoid unnecessary digging. The following techniques are available:

- Steel pipes may be located using electromagnetic *metal detectors*, sometimes inducing a signal into the pipe from a valve or hydrant that may be picked up by an above-ground sensor.
- *Other methods* include ground-penetrating radar, sonic wave methods and infrared thermography.
- *Excavating* across the line of the pipe is a technique that may be used

if other techniques are not available or fails. Care should be taken not to cause damage to the pipe with a pick or shovel during the digging process.

It is a good idea to get different suppliers to demonstrate their equipment on a known section of pipe to ascertain their effectiveness before deciding on a system to purchase.

6.6.2 Locating leaks

Various techniques exist for finding leaks through active detection. Some methods are better suited to certain pipe materials and diameters, and whether the pipe has service connections on it or not. The main techniques are briefly explained below, and recommendations for methods to use are given in Table 15 and Table 16⁴:

- *A. Gas injection.* In this method a gas detector is used to find the presence of a tracer gas that has been injected into an emptied pipe. Hydrogen is the most common gas employed, but helium can also be used. A probe is used along the route of the pipeline to detect gas released through leaks in the pipe.
- *B. Manual listening stick.* A stethoscope or listening stick with an earpiece is pressed against fittings to listen for nearby leaks in the pipe.
- *Leak noise correlation.* Leak noise correlators work by comparing the noise detected at two different points on the pipeline. The times that a noise signal reaches the respective sensors are used to estimate the location of the leak on a pipe. Noise correlators will also pick up non-leak sources of noise,

and thus the existence of a leak should be verified, for instance using a ground microphone. Two types of noise correlators are used:

- **C: Accelerometers.** In this method, two accelerometer sensors are deployed on pipe fittings on either side of the suspected leak position. This method is most effective on metallic pipes.
- **D: Hydrophones.** Leak location with accelerometers is harder in plastic pipes due to their higher elasticity, and in large diameter pipes due to the higher diameter to wall thickness ratios. Hydrophones are placed in contact with the water, for instance at hydrants, and pick up the noise signal directly from the water.
- **E: In-line detection techniques.** These techniques are suitable for large diameter pipelines. Probes are placed

in the pipe and pick up leak noises as they pass through it. Tethered and free swimming systems are available.

- **F: Leak noise loggers** are placed on fittings and pick up the noise created by a leak in the pipe.

6.6.3 Repairing leaking pipes

The following steps are used to repair a leaking pipe:

1. **Locate the failure** from an external sign such as a water jet or wet area of soil, or from specialised leak detection equipment.
2. **Close isolation valves** in the system to isolate the leak. Clearly mark each valve that is closed, for instance on a worksheet or with a physical marker such as danger tape on the valve itself.

Table 15 Recommended leak detection techniques on pipes without service connections¹

Pipe material	Small diameters (75 – 400 mm)	Large diameter pipes (from 300mm)
Metals	A, B, C, D, F, G	C, D, E
AC	A, C, D	E
PVC	A, D	E
Polyethylene	A, D	E

Table 16 Recommended leak detection techniques on pipes with service connections¹

Pipe material	Small diameters (75 – 400 mm)	Large diameter pipes (from 300mm)
Metals	A, B, C, D, F, G	C, D, E
AC	A, C, D, F G	E
PVC	A, D, F G	E
Polyethylene	A, D, F G	E

3. Ensure that the **work area is safe** for working using appropriate signs, barriers and traffic diversion measures.
4. **Excavate** the failed pipe section while ensuring worker safety and avoiding further damage to the pipe.
5. Use an extractor pump capable of handling sludge to **drain water** from the trench.
6. **Repair** the failed pipe using an appropriate method:
 - a. For a small leak, a **repair clamp** may be fixed over the leak to seal it. Small leaks in steel pipe may be welded closed.
 - b. For a more extensive leak, the **damaged section of pipe is cut out**, a new section of pipe installed using appropriate connectors. PVC is often used for the replacement section and special fittings are available to connect PVC to other pipe materials. Note that AC pipes should not be cut – rather replace a whole length of pipe.
 - c. **Replace a whole length** of pipe if damage is extensive or it is clear that the pipe is bad condition and likely to fail again.
7. In all cases, ensure that exposed and new sections of pipe are **carefully cleaned and disinfected** (see Section 6.6.5). Take special care to ensure that any solids that may have entered the pipe during the repair are removed.
8. **Slowly** open one or more of the closed isolation valves as well as a hydrant or valve to **allow air to escape** from the system.
9. Ensure that all isolation and scour valves opened or closed are reinstated to their correct state.
10. **Flush** the section using a hydrant to ensure that any contaminants and solids are removed.
11. Once the section is under pressure, **inspect the repairs for leaks**.
12. Reinststate the pipe **bedding, blanket and backfill** using appropriate placing and compaction methods and materials.
13. **Reinststate and clean** the area where the excavations were done.
14. Complete a **pipe repair report**, including an analysis of the likely cause of the failure. Failure reports should be securely stored for future reference. A sample form for pipe repairs is provided in Appendix B.

6.6.4 Trenchless rehabilitation and replacement of pipes ^v

Trenchless technologies refer to a range of techniques used to replace or rehabilitate pipes with minimal excavation. Excavation is mainly required to gain access to the start and end of a pipe section, and most techniques are limited to a straight section of pipe only. All service connections, valves and other fittings also have to be individually excavated and reinstated on the new pipe.

Various trenchless options are available to rehabilitate a pipe that has reached the end of its service life, which may be indicated by a high failure frequency, high friction losses or water quality problems. These



Figure 13 Some steps in the pipe repair process: a) ensuring the work area is safe; b) carefully excavating the pipe; c) draining water from the hole; d) repairing the leak with a repair clamp.

methods may be divided into three categories: non-structural lining, structural lining and replacement.

In non-structural lining, a thin coating of a material is placed in the pipe to prevent leaks and increase the service life of the pipe. Before non-structural lining, the pipe needs to be cleaned to remove scale, corrosion products and sediments. Common non-structural lining techniques include the following:

- **Cement-mortar lining** applied by special equipment to the inside of the pipe. The thickness of the lining can be varied, but is typically large enough

to create a significant reduction in the diameter of smaller pipes.

- **Epoxy lining**, which places an epoxy lining of about 1 mm thick on the inside of the pipe.

Structural linings provide a new surface inside the existing pipe that also provides at least some structural support. Common structural lining techniques include the following:

- **Sliplining**. In sliplining, a new pipe with a smaller diameter is pulled in through the existing pipe. It is a relatively simple and inexpensive technique, but the new pipe has a smaller

diameter and thus a reduced flow capacity, typically between 35 and 60% depending on the size of the pipe. HDPE pipe is mostly used as the replacement pipe since it is supplied in long lengths and is flexible.

- **Cured-in-place** pipe consist of a fabric tube, impregnated with a thermosetting resin that hardens into a structurally sound jointless pipe when exposed to hot circulating water or steam.
- **Fold and form** and **close-fit** pipes uses thermoplastic materials such as PVC or polyethylene that are heated and deformed into a U shape or somehow reduced in diameter so that it can be inserted into the existing pipe. Hot water or steam is applied until the liner has been heated enough to regain its original circular shape.

Trenchless pipe replacement methods, where the existing pipe does not play any continued supporting role in the new pipe, include the following:

- **Pipe bursting** involves the use of a pipe cutting or bursting tool that breaks and opens up the old pipe. The replacement pipe (mostly HDPE) is pulled into the void left by the cutting tool. The replacement pipe can be up to two pipe sizes larger than the existing pipe.
- **Microtunneling** uses a remote controlled laser-guided pipe jacking system that forces a new pipe horizontally through the ground. The method can be cost-effective in built-up areas, to install pipes through existing roads or in areas sensitive to disturbance by surface excavation. Various types of pipes

can be installed in this way.

- **Horizontal or directional drilling** uses a drill rig that pushes a cutting or drilling head steered from the surface. Drilling fluid is pumped in behind the head to keep the hole open.

Table 17 provides a summary of the main rehabilitation methods and the pipe size range where they are applied, arranged from the lowest to highest cost according to a study done in the USA ^v. The cost of pipe rehabilitation depends on local conditions and is affected by various factors, including the total length of the project, pipe diameter, pipe material, access to the pipe, cleaning prior to application, excavation of insertion and receiving pits, pavement removal and replacement above the pits, and the replacement of valves, house connections and other fittings.

Table 17 Methods used for pipe rehabilitation arranged from low to high cost ^v

Method	Pipe size range (mm)
Cement mortar lining	100 - 1 500
Epoxy lining	100 - 300
Sliplining	100 - 2 500
Close-fit-pipe	50 - 1 000
Fold and form pipe	200 - 500
Pipe bursting	100 - 900
Cured-in-place pipe	150 - 1 400
Microtunneling	300 - 3 700
Horizontal directional drilling	50 - 1 500

6.6.5 Disinfection

Pipes and fittings need to be disinfected before they are connected to the distribution system, either when new pipes are installed or when pipes are exposed for repairs. The first requirement is to keep the pipe as clean as possible during all storage, transport and installation steps. A pipe trench is not a clean environment and mud and contaminated water is often present.

Workers should be trained to understand the need to keep the inside and joints of a pipe as clean as possible during construction, and know the potential consequences of not doing this.

To disinfect the pipe it is first flushed to clear any dirt left in it before being filled with water with a chlorine content of at least 25 mg/l for at least 24 hours. Calcium

hypochlorite granules or sodium hypochlorite liquid (liquid bleach) may be used as sources of chlorine. The water in the pipe should have a chlorine residual of at least 10 mg/l at the end of the period. Alternatively water with a chlorine concentration of 100 mg/l should be left for at least three hours, after which the residual chlorine concentration should be at least 50 mg/l.

The pipe is then flushed with potable water before connecting it to the rest of the network. Chlorinated flushing water should be dechlorinated or disposed of in a way that will not damage the environment.

When pipes are repaired they should also be flushed and disinfected. If it isn't possible to leave the disinfectant in the pipe for the required period, a precautionary "boil water" notice should be issued to affected consumers.

Important points

- Never cut or grind AC pipes due to the health risk of asbestos fibres when inhaled.
- Ensure that pipes were manufactured from high quality materials and with good quality assurance checks, particularly for plastic pipes.
- The use of correct equipment, well trained workers and good quality assurance measures are essential when doing butt or electrofusion welding.
- Steel and ductile iron should always be protected from corrosion.
- Do not store PVC pipes in direct sunlight.
- Ensure that grit and dirt do not enter the pipe system when doing pipe construction or repairs.
- Ensure that new or repaired pipes are flushed and disinfected before connecting them to the rest of the network.

Additional Reading

South African National Standards

Pipe Selection

- SANS 10102-1: 2013 - The selection of pipes for buried pipelines Part 1: General provisions

Ductile iron pipes

- SANS 10804-1:2010 - Restrained joint systems for ductile iron pipelines Part 1: Design rules and type testing

Polyethylene (PE) pipes

- SANS 4427:1996 - Polyethylene (PE) pipes for water supply - Specifications
- SANS 4427-1:2008 - Plastics piping systems - Polyethylene (PE) pipes and fittings for water supply - Part 1: General
- SANS 4427-2:2008 - Plastics piping systems - Polyethylene (PE) pipes and fittings for water supply - Part 2: Pipes
- SANS 4427-3:2008 - Plastics piping systems - Polyethylene (PE) pipes and fittings for water supply - Part 3: Fittings
- SANS 4427-5:2008 - Plastics piping systems - Polyethylene (PE) pipes and fittings for water supply - Part 5: Fitness for purpose of the system
- SANS 10112:2011 - The installation of polyethylene and poly vinyl chloride (PVC-U and PVC-M) pipes

PVC pipes

- SANS 966-1:2013 - Components of pressure pipe systems Part 1: Unplasticized poly vinyl chloride (PVC-U) pressure pipe systems
- SANS 966-2:2013 - Components of pressure pipe systems Part 2: Modified poly vinyl chloride (PVC-M) pressure pipe systems

Ductile Iron Pipes

- SANS 10802:2010 - Ductile iron pipelines - Hydrostatic testing after installation
- SANS 10803:2010 - Design method Training

Pipe Installation (Civil Engineering Construction)

- SANS 1200 DB:1989 - Standardized specification for civil engineering construction
- Section DB: Earthworks (pipe trenches)
- Section L: Medium-pressure pipe lines
- Section LB: Bedding (pipes)
- Section LF: Erf connections (water)
- Section LG: Pipe jacking
- SANS 10120-2 L:1983 - Code of practice for use with standardized specifications for civil engineering construction and contract documents Part 2: Project specification
- Section L: Medium-pressure pipelines
- Section LB: Bedding (pipes)
- Section LF: Erf connections (water)
- SANS 10120-3 L:1983 - Code of practice for use with standardized specifications for civil engineering construction and contract documents Part 3: Guidance for design
- Section L: Medium-pressure pipelines
- Section LF: Erf connections (water)
- SANS 10120-4 L:1983 - Code of practice for use with standardized specifications for civil engineering construction and contract documents Part 4: Typical schedule of quantities
- Section L: Medium-pressure pipelines
- Section LB: Bedding (pipes)
- Section LF: Erf connections (water)
- SANS 10120-5 L:1983 - Code of practice for use with standardized specifications for civil engineering construction and contract documents Part 5: Contract administration
- Section L: Medium-pressure pipelines
- Section LB: Bedding (pipes)
- Section LF: Erf connections (water)

PIPE FITTINGS AND ACCESSORIES

7.1 Introduction

Water distribution systems require a large range of fittings and accessories to link pipes into a network and facilitate operation and maintenance. This chapter discusses the different types of fittings and other components used in distribution systems and how they should be operated and maintained. The focus is on individual components since the operation and maintenance of the network are discussed in other chapters.

The following general requirements apply to most fittings and accessories:

- Where feasible, all components should be placed in valve chambers to protect them from the elements, accidental damage and vandalism. A limited range of each component should be used to reduce the number of spare parts that is required and make repairs easier to perform.
- Components should be trans-

ported, stored and handled carefully and according to manufacturer specifications.

- Where soft water is conveyed in the distribution system, brass components should be de-zincification resistant (DZR).
- Flanges should be clean and free of grease, and bolts should be tightened in a diagonal pattern.
- Details of all components should be clearly shown on as-built drawings and included in GIS databases. This allows components to be found when they are hidden, for instance by soil or by tar during road resurfacing.

A checklist for recommended maintenance intervals of network pipes and components is provided in Appendix B.

7.2 Valves

Various types of valves are used in distribution systems to shut down sections of

the network, release air or regulate flow or pressure in the system. The main types are the following:

- Isolation valves
- Air valves
- Scour valves
- Non-return or check valves
- Control valves

7.2.1 Isolation valves

Isolation valves are used to close off and thus prevent any flow through pipes. This may be required to shut down a section of pipe for repairs or isolate one supply zone from another. Most valves are made out of steel, ductile iron or cast iron. Gate valves are typically used for isolation of small diameter pipes, while butterfly valves are used for large diameter pipes.

Isolation valves are installed at junctions in pipe networks and at regular intervals of one to two kilometres on transmission lines. They should be located near street corners and in line with property side-boundaries so that they are easier to find. All isolation valves in a system should close in a same direction, whether clockwise or anti-clockwise.

Isolation valves can shut the flow off with a close fitting metal-to-metal seal or alternatively use a rubber seal (called a resilient seal valve). While resilient seal valves are generally cheaper and have some operational advantages, the rubber seal tends to lose its flexibility when the valve is closed for long periods of time, resulting in the valve subsequently not being able seal perfectly. Thus, resilient seal valves can be used in locations

where they have to be opened frequently, or will be open most of the time. However, critical valves that are closed most of the time, such as scour or DMA isolation valves, should use a metal-to-metal seals.

Isolation valves are prone to deterioration and failures such as stripped, broken or bent stems, leaking O-rings or packing, corrosion of the valve body and bolts and wear on the valve disk and seat ^h.

Isolation valves have the following operational requirements:

- Isolation valves should ***only be operated by staff trained and authorised to do this***, and all changes in valve setting should be recorded on a form designed for this purpose. Contractors should not be allowed to operate valves without being specifically authorised to do this and complying with the same standards as municipal staff.
- Gate valves should not be used to isolate pipes for ***pressure testing*** when the testing pressures exceeds the operational rating of the valve, as this can damage the valve seals.
- Isolation valves should be ***opened and closed slowly*** (approximately 10 minutes), especially on large pipelines to prevent water hammer. Valves on pipes with a water hammer risk should be fitted with gearboxes or actuators that regulate the valve closing speed.
- A gate valve should be turned until it is completely opened or closed, and then half a turn in the opposite direction. This helps to prevent the valve from getting stuck.

- **Gate valves should not be used to throttle flow** as the high velocity of water through a small valve opening can cause cavitation and scour damage to the valve. Butterfly valves are better suited to throttling.
- Large isolation valves should be fitted with **bypass valves** to allow the pressure to be equalised on both side of the large valve before it is opened.
- To prevent operators from using too much force when closing a valve resulting in shearing of the valve stem, it is advisable to use **special valve keys** that will not allow excessive force to be transmitted to the valve, or teach operators the number of turns required to close the valve (and thus not force it further).

Maintenance requirements of isolation valves include the following:

- Valves should be **inspected and maintained** on a regular bases, but at least once a year. Gate valves should be checked for leaks around the stem and flange gaskets. Nuts and bolts should be tightened, avoiding over-tightening. The valve body should be cleaned and corrosion protection applied when necessary. The valve stem and nut should be lubricated. Seals and gaskets should be replaced every five years.
- Isolation valves should be **exercised (opened and closed) at regular intervals** to ensure they are operational and don't get stuck.
- **Valves with gearboxes** should be serviced once a year, replacing gland packing and cracking the valve (close it

slightly before opening it again) at least once a year. However, critical valves in the system should be inspected at more regular intervals to ensure they are ready should it become necessary to operate them.

7.2.2 Air valves

Air valves are installed on pipelines to control the flow of air into and out of the system. Pipelines should be completely filled with water under normal operating conditions, and thus any air that enters a system needs to be released. This is necessary when filling a drained pipe, or when air enters the system as bubbles or dissolved in the water. If the air is not released, it will accumulate at high points in pipes, restricting and even preventing flow altogether.

Air should be allowed to enter a pipe when it is emptied, for instance to repair a leak, or when pressures drop below atmospheric pressure, for instance due to negative transient waves after a sudden pump stoppage.

Air valves operate by automatically opening a valve when air accumulates in the valve body or negative pressures occur in the system. The valve also closes automatically when the air has been expelled. Most air valves operate using a floating device that moves up and down with the water level in the air valve chamber. Different designs are used for small and large air flows, but combination air valves incorporate both types in a single body.

Air valves installations should include an air trap diameter similar to that of the pipe (typically a T-piece) onto which a smaller diameter isolation valve is connected (to

allow air valves to be removed for maintenance purposes), followed by the air valve itself. It is a good idea to have a small vent valve close to the air valve to allow maintenance staff to check that the air valve is isolated from the system pressure before dismantling it.

Air valves are not required everywhere in distribution systems since air is able to escape through consumer taps and valves. Bulk pipelines require air valves at high points in the pipe profile, where the pipe bends downwards and at regular intervals on straight pipe sections. In addition, air valves are required at isolation and check valves where negative pressures may occur when draining the pipeline.

Air valves experience two common problems: blocking of the orifice and the float getting stuck. Thus air valves should be checked at least every six months and maintained at regular intervals. Air valve should never be isolated or removed from the pipeline while the pipe is operational as the absence of the air valve may result in damage to the pipeline.

It is recommended that spare air valves be used to immediately replace valves removed for maintenance purposes. The removed valve can then be opened, cleaned and lubricated in a workshop. Corrosion on the outside of the valve should be removed and the valve sealed with appropriate epoxy paint.

Air valve chambers should be regularly inspected to ensure that air valves are not submerged by rainwater or a pipe leak, their isolation valves open, the valve chamber air vents open and insect screens intact.

a)



b)



c)



d)



Figure 14 Examples of valves: a) large butterfly valve with a small butterfly valve on a bypass pipe; b) scour valve; c) scour pipe outlet; d) air valves.

7.2.3 Scour valves

Scour valves are used to drain pipes for maintenance purposes. It typically consists of a reduced diameter off-take pipe closed with an isolation valve. In distribution networks, fire hydrants are mostly used to drain pipes instead of scour valves. On long pipelines, scour valves should be provided at the lowest points in the pipe profile. Each section of pipe that may require draining should be provided with a scour valve.

Scour valves should use metal-to-metal seals (and not resilient seals) and their outlets should be clearly visible so that they cannot be accidentally left open. The designer should consider the route of the water leaving a scour valve and ensure that it can safely flow into a watercourse or storm water drain. Adequate erosion protection should be provided near the valve to avoid damage by the drainage water. The scour valve should be inspected, cleaned of plant material and debris, and tested at least once per year.

7.2.4 Non-return valves

Non-return or check valves only allow flow in one direction. If water flows in the opposite direction, the valve automatically closes one or more flaps or diaphragms, shutting off the flow. Non-return valves should preferably be provided with counter-weights to ensure that they fully close when there is no flow in the pipe. If this does not happen, a sudden return flow can cause the valve to slam closed violently, resulting in damage to the system.

Non-return valves should be installed whenever flow is only allowed in one direc-

tion, including directly downstream of pumps, on pump bypass pipes and on large consumer connections.

Non-return valves generally have to be removed from the pipe for inspection and maintenance work, but don't need much attention. However, it is important to check that they still seal well from time to time, particularly on pump bypasses where a leaking non-return valve can cause significant reductions in pump efficiency.

7.2.5 Control valves

Control valves are used to control the flows or pressures in a distribution system by automatically varying their degree of opening in response to changes in system conditions. They use pressure from the network to open and close the valve, and thus do not normally require an external power source. Small diameter metal tubes are used as hydraulic circuits to transmit pressure signals from different parts of the valve or pipe to actuators that regulate the valve opening. Different hydraulic circuits are used to produce different types of control valves. The most common control valves in distribution systems are as follows:

- **Pressure reducing valves (PRVs)** ensure that the pressure on their downstream sides do not exceed a given value.
- **Pressure sustaining valves (PSVs)** maintain a given minimum pressure on their upstream sides.
- **Flow control valves (FCVs)** ensure the flow rate passing through them doesn't exceed a given value.

- **Level control valves** close when a reservoir is full, and opens when the water level drops to a pre-determined level.
- **Surge control valves** open or close to help dissipate water hammer pressures in a pipe or protect components against it.
- **Pump control valves** prevent water hammer from occurring in a system by controlling the rate at which the flow changes when pumps are started or stopped.

Control valves are used where special controls are required in a network, such as flow or pressure control. Most control valves also function as non-return valves. Control valves generally have a certain range that they can operate on, and in some cases it is necessary to use more than one valve in series or parallel to get the desired results.

Designers should consider the consequences of a control valve failing and ensure that

this will not result in permanent damage to the system. For instance, the distribution downstream of a PRV should be able to handle the increased pressures if the PRV fails. Break-pressure tanks may provide a fail-safe alternative where this is a risk. It is also advisable to monitor pressures upstream and downstream of control valves to allow the operation of the valves to be monitored.

Control valves must be kept clean from dirt and insects, especially the breather holes on the valves and pilots. They should be inspected at least twice a year (more for large control valves) and serviced every three years.

7.3 Fire hydrants

Fire hydrants are used to provide water from the distribution system for fire fighting. Fire hydrants incorporate an isolation valve and a standard fitting for connecting a fire hose.

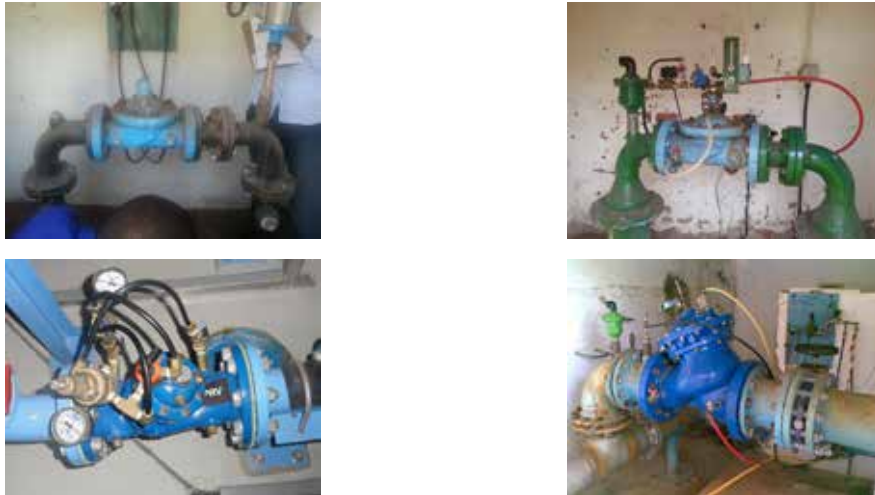

Figure 15 Examples of control valves

Break-pressure tanks

Break-pressure tanks are essentially small reservoirs that are used to prevent excessive pressure in the distribution system on their downstream sides. A break-pressure tank accepts water from the supply system through an automatic shut-off valve and then supplies the water through a separate outlet. Break-pressure tanks have the same functionality as pressure reducing valves, but are inherently safer since failure of the

break-pressure tank will not result in excessive pressures in the downstream system. Break-pressure tanks are more expensive to construct than pressure reducing valves, but should be considered in areas where the upstream pressures can cause serious damage to the system, or where control valve maintenance is not possible or is unlikely to be done.

Fire hydrants should be installed at 120, 180 and 240 m distances respectively in high, medium and low fire risk areas in networks on 75 mm diameter and larger pipes. They should be able to provide flow rates of 1500 l/min in High and Medium fire risk areas, and 900 l/min in Low fire risk areas. Hydrants should be provided at all dead ends in the pipe network to allow these pipes to be flushed.

Hydrants are often used for operation and maintenance functions in water distribution systems, such as flushing pipes, releasing air and logging pressures. However, such actions should never prevent the hydrant being accessible for its primary purpose of providing water for fire fighting.

Hydrant locations should be clearly marked to allow fire services to find them. They should be protected against obstruction, for instance by vehicles parking over them. Hydrants can be damaged by vandals, traffic and construction activities and should be protected against these where possible.

Hydrants on private properties are sometimes connected to the network through a separate unmetered connection, providing an opportunity for illegal connections to be

accidentally or deliberately made. Thus it is preferable that such hydrants is connected through a flow meter capable of handling the high flow rates required for fire fighting. Alternatively a check mechanism may be installed to indicate that a hydrant has been used.

Water services should work closely with fire services to ensure that their requirements are understood and accommodated in the provision of fire water.

Fire hydrants have the following maintenance requirements:

- Hydrants in high fire-risk areas should be **inspected** on a regular basis and in other areas annually to ensure they are ready to perform in case of a fire emergency.
- Hydrants should be **serviced and their flow rate checked** to comply with the required flow rate at least once per year. Obstacles and plants around hydrants should be cleared. The hydrant box or chamber should be cleaned of sand and debris, and the valve opened to check that it operates correctly. Stems and nozzles should be checked and

flange bolts tightened if necessary. The hydrant body should be cleaned and corrosion protection applied if required.

of the meter, including expected service life, loss of accuracy over time and failure rate, and not on purchasing price only.



Figure 16 Examples of fire hydrants

7.4 Water meters

Water meters are discussed in detail in a companion book “Introduction to integrated water meter management” available from the Water Research Commission. Water meters are used to measure the volume of water that passes through them. All consumer connections should be metered, including standpipes and other supply points. Water meters are also used to measure bulk transfers (e.g. from bulk suppliers or other municipalities), consumption in district metered areas (DMAs) and the flow of water in the network.

Water meters should be correctly sized and installed strictly in accordance with the manufacturer’s requirements. Meter selection should be done based on lifecycle cost

Meters should be read on a monthly basis, preferably at the same time of the month. Meter readings should be verified to ensure that they do not contain errors before the readings are used to bill consumers. Metering data should also be made available to engineering and management to use for water demand management, water loss calculations and long term planning.

Water meters should be inspected on a regular basis and required maintenance done without delay. Priority should be given to system input and bulk consumer meters. Maintenance includes the cleaning of strainers, cleaning and repair of meter boxes, fixing of leaks and replacing damaged registers and register covers. Where possible, larger water meters should be opened and their mechanisms inspected

for signs of damage or wear. A checklist should be completed by maintenance crews that include location and meter data, condition of the meter and auxiliaries and actions taken.

Knowledge of the system should guide a municipality on maintenance requirements of different meter models in different sup-

ply areas. The meter database should be used to identify meters that need urgent inspection or maintenance, and information obtained from maintenance visits should be fed back into the database for future use. It is recommended that maintenance is done on large water meters at least once a year. Domestic meters require less frequent

Water meter reading (adapted from p)



It is important that water meters are read at regular intervals, preferably once a month. In some cases meters are read less frequently and the readings of the intermediate months are estimated. This practice saves money, but can also introduce significant errors that may create problems when sudden large water bills are sent to correct wrong estimates.

Water meters are always read in the same direction as reading a book, i.e. from left to right. By law, all meters have to measure in cubic metres (m^3 or kilolitres), and must clearly distinguish between full cubic metre values and fractions of a cubic metre. In some meters this is done using contrasting colours; typically white numbers on a black background for full cubic metre values and white numbers on a red background for fractions. In other meters, rotating disks are used for full cubic metre values, and dials for fractions. Electronic indicators often use a decimal point or display the fraction values in

a smaller font. It is common practice for meter readers to only read the full m^3 values.

Meter readers should be precise and not suffer from any reading impairments. Proper training of meter readers is very important. When reading, both the meter serial number and meter reading should be taken to ensure the data is correctly assigned. It is also important that meter readers should be trained to identify and report problems with meters, such as signs of tampering, damage to meter boxes and leakage.

Meter readers should be provided with the correct tools, and properly trained on safety measures when reading meters. Injury can result from opening manhole covers without the proper tools and dangerous animals (such as snakes or bees) may potentially hide inside meter boxes.

maintenance and meter readers may be used to report on leaks or problems that require attention. Meters of 50 mm and larger can often be serviced instead of replaced. However, a municipality should have the capability to calibrate and test meters before servicing can be an option.

Like any mechanical device, water meters deteriorate with use and generally under-register as they age. The starting flows and accuracy at low flows are the areas on the accuracy curve that tend to deteriorate most rapidly.

It may also be desirable to log the flow through an existing meter in the system to characterise the flow pattern through the meter, or determine if the meter is correctly sized.

The accuracy of meters needs to be checked to ensure they are still operating satisfactorily. Meters of 100 mm and larger should be tested once a year and smaller meters once every five years. It is not feasible to test all domestic meters, and a representative sample of domestic meters should rather be tested based on size, model and year of installation, to estimate their performance. Meters may be checked in situ using a calibrated master meter, portable test rig or insertion flow meter. However, if a meter needs to be verified for trade purposes, such as a legal dispute on meter accuracy, the meter has to be tested by a certified testing officer in an approved testing laboratory.

An adequate number of spare meters should be available to replace broken or faulty meters without delay.

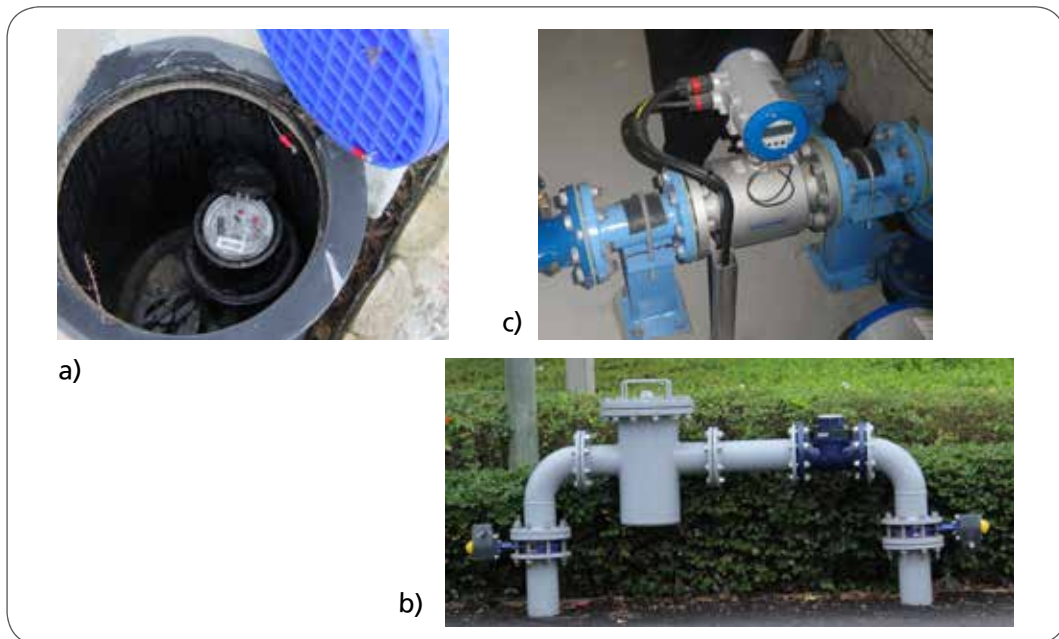

Figure 17 Examples of water meters: a) domestic meter installation; b) bulk consumer meter installation with isolation valves and dirt box; c) electro-magnetic meter installation.

7.5 Chambers

Chambers are used to house network fittings and components that need to be accessed for operational and maintenance purposes. Chambers may be constructed from reinforced concrete, bricks, cast iron or even plastics in the case of small chambers such as meter boxes.

Valve and component chambers should comply with the following requirements:

- Have **adequate space** for workers to install, remove and work on pipes and fittings installed.
- Where air valves are installed in the chambers, adequate provision for **air movement** in and out of the chamber.
- **Roof slabs and access openings** should allow all installed components to be removed and reinstalled, and should be able to handle the anticipated loading on them.
- Preferably **stand proud of the ground level** to ensure that storm water cannot enter the chamber.
- **Anchoring of pipes** in the valve chamber walls, and allowance for differential settlement between the pipe and

valve chamber.

- Allowance for space to remove and reinstall components with ease through the use of a **mechanical coupling**.
- **Secure exposed parts** of the network (e.g. valve chambers) from accidental damage and vandalism.
- Have an access opening with **lockable covers**.
- Steps should be taken to ensure that chamber covers are **not covered** by soil, construction work or road surfaces (e.g. when resurfacing the road).

7.6 Markers

Municipal employees must know where a pipe and other components are located before they can be excavated, for instance to repair leaks or connect consumers. Since pipes are buried and thus not visible above the ground, it is necessary to install above ground markers that indicate the position of the pipes. Valve boxes and hydrants may also be used to indicate the position of a pipe. It is good practice to install components at fixed locations, such as opposite stand boundaries to make it easier to find them.



Figure 18 Examples of chambers

Markers should be used to indicate the positions of important fittings, either through permanent marker posts on the verge opposite the fitting, or by painted symbols on the road surface, kerb, telephone poles or other structures. Symbols on markers should be durable and markers should be repainted or replaced at regular intervals.



Figure 19 Examples of pipe and valve markers

Pipe markers or beacons should be installed at pipe bends and at regular (no more than 500 m) intervals to ensure that its location can be determined. Where a pipe crosses underneath a road or other obstacle, pipe markers should be installed on both sides of the road. The pipe should follow straight lines between these markers.

7.7 Thrust blocks

Water in a distribution system exerts forces on pipes and fittings in the system through pressure, changes in momentum and transient pressure waves. At certain points in the network, the internal forces are unbalanced and may cause joints to move or open up to create a leak. For this reason, it is necessary to provide thrust blocks that transfer unbalanced pipe forces to a structure or undisturbed soils and so keep components in place. Examples of thrust blocks in distribution systems are shown in Figure 20.

Thrust blocks should be installed wherever unbalanced internal forces may cause components to move, such as at:

- Changes in flow direction, such as bends and junctions.
- Dead ends.
- Changes in pipe diameter.
- Components that may be susceptible to internal forces, such as valves.

Thrust blocks are really important and should be immediately replaced whenever they are removed for maintenance purposes. Quick-hardening cement should be used where a pipe needs to be placed back in operation urgently.

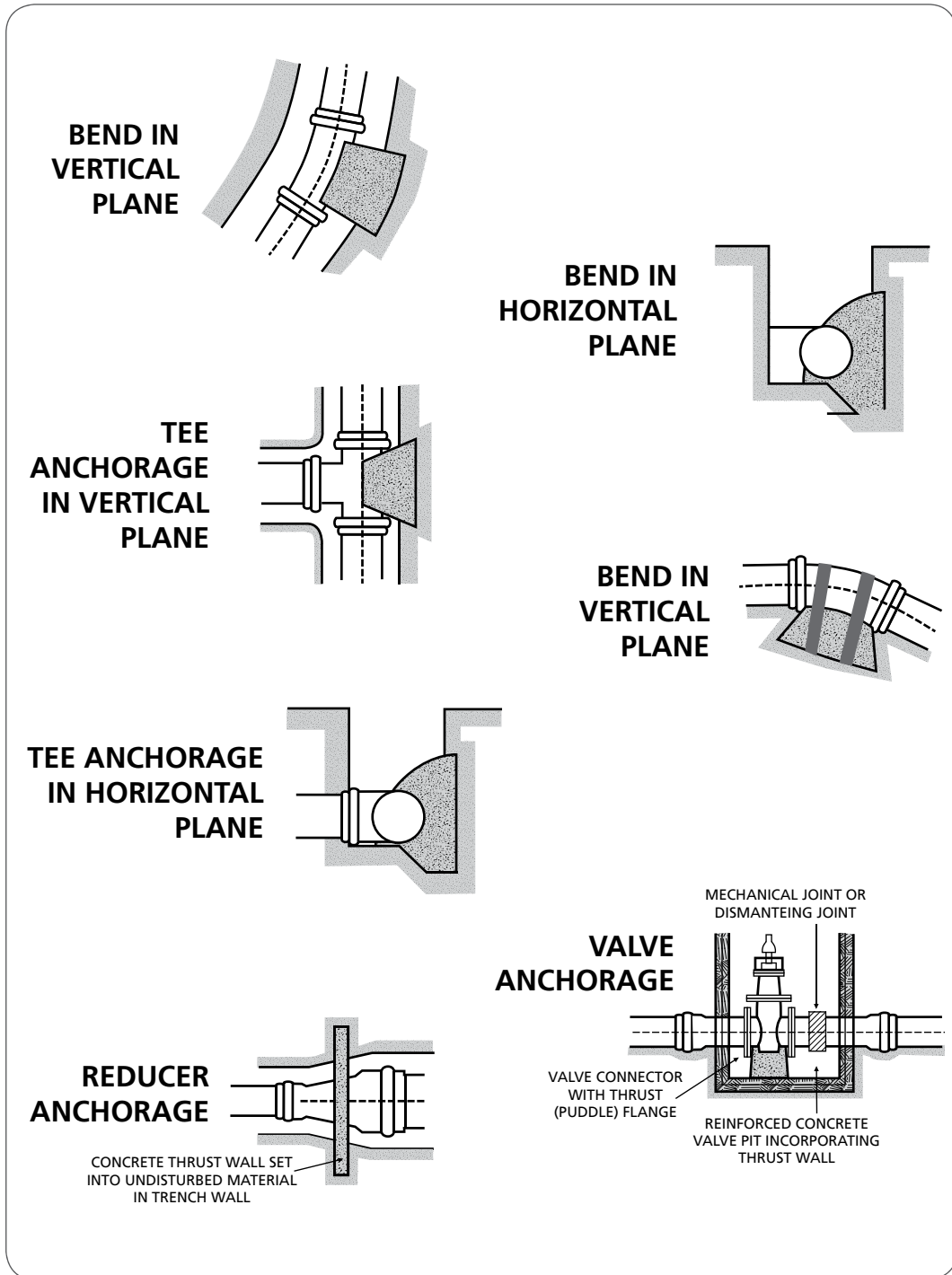

Figure 20 Examples of thrust blocks used in distribution systems.

Important points

- The positions of pipes, valves, hydrants and other components should be clearly marked in the field and accurately shown on drawings to allow them to be easily located.
- Resilient seal valves should not be used for valves that are closed for long periods of time, such as scour or DMA isolation valves.
- Isolation valves should always be opened and closed slowly, especially in large diameter pipes, to prevent water hammer.
- Gate valves should not be used to throttle flow.
- A pipeline should never be operated while any of its air valves is isolated or missing.
- Air valve chambers should have air vents that allow unobstructed air flow.
- The outlet of scour valves should be protected from erosion and visible to allow releases to be observed.
- Thrust blocks should always be replaced, if removed during maintenance, before a pipe is put back into operation.

Additional Reading

South African National Standards - Pipe Components

- SANS 4633:2008 - Rubber seals - Joint rings for water supply, drainage and sewerage pipelines - Specification for materials

Water metering

- *Introduction to Integrated Water Meter Management* by JE van Zyl provides a practical guide to municipal water metering in developing countries. It can be ordered from the Water Research Commission, or downloaded from their website www.wrc.org.za.

RESERVOIRS AND WATER TOWERS

8

8.1 Introduction

Water demand in a distribution system is highly variable and changes with the season, day of the week and hour of the day. In addition it is affected by various external factors such as temperature, rainfall and public holidays. In contrast to the variability in water demand, components such as water treatment plants, pump stations and bulk pipelines are designed for a fixed flow rate for cost and operational reasons. An important function of storage reservoirs is to provide balancing storage between the constant inflow and variable outflow. This means that reservoir water levels drop during the day when consumption is high, and increase again during the night when consumption is low.

Other functions of reservoirs include the provision of emergency storage (for instance when the pipe supplying the reservoir is shut down to repair a burst) and ensuring that water is available for fire fighting. Finally, the water elevations of reservoirs and water towers determine the pressure that can be supplied to users through gravity.

8.2 Reservoirs and water towers

It is important to distinguish between reservoirs and water towers as they have different functions: reservoirs are constructed on ground level and provide the bulk of the required storage volume. Where possible, reservoirs are located on higher ground above the system to provide the required pressure. However, in some cases users are located at high elevations relative to the reservoir and thus cannot be supplied with adequate pressure. In these cases water towers are commonly used to provide additional pressure for these users. Since it is expensive to provide elevated storage, water towers are sized for a few hours of peak demand only, and the pumps that supply them are sized to provide the peak user demand. Little emergency storage is provided in water towers, with the ground storage reservoirs holding the bulk of the required emergency storage.

Reservoirs are mostly constructed from reinforced concrete, although smaller reservoirs are sometimes built out of bricks or steel panels. Water towers are mostly



Figure 21 Examples of reservoirs and water towers

constructed out of reinforced concrete or steel panels. Jointing on all types of reservoirs and water towers are very important and needs to be specially designed and constructed to prevent leakage.

8.3 Deterioration and common failure patterns

Like other infrastructure, reservoirs and water towers need to be operated within their design limits and well maintained to ensure that they continue to provide a high quality service. A very important component is to ensure that the stored water is protected from contamination, and this requires attention to details such as insect proofing at air vents and ensuring that the reservoir

remains dark.

The main deterioration patterns that occur at reservoirs and water towers are as follows:

- **Erosion of ground** below and around reservoirs by rain, scour and overflow water.
- **Corrosion of metal or concrete** elements submerged in water or subjected to the high humidity inside a reservoir. Concrete is particularly susceptible to corrosion when in contact with soft waters.
- **Vandalism**, sometimes by livestock owners to get access to water (normally from the scour valve) or people wanting to explore the area.

- Contamination of stored water through ***rainwater, animals or even humans*** entering the reservoir.
- ***Chlorine depletion and disinfectant by-products*** forming when retention times of water in the reservoir are too long.
- ***Algae growth*** that can lead to taste and odour problems.
- ***Silt build-up*** on the floor that can cause dirty water and bacterial contamination.

8.4 Operation and maintenance of reservoirs and water towers

8.4.1 Design and construction

8.4.1.1 Reservoir sizing

Larger reservoirs are less likely to run dry and are thus inherently more reliable. However, larger reservoirs cost more to construct and maintain, and increase the time water spends in the system (called the retention time). Longer retention times increase the risk of chlorine depletion and disinfectant by-product formation. The challenge for the system designer is thus to find an appropriate balance between the risk of a reservoir running dry and operational costs and problems.

The South African design guidelines specify reservoir capacity of 48 hours of annual average daily demand (AADD) plus allowances for fire fighting and operational requirements. This has been shown to be excessive for many systems using stochastic

analysis simulations ^r that allow reservoirs to be sized based on local conditions. In addition, it is possible to further reduce the required reservoir capacity by providing a larger and more reliable supply capacity to the reservoir than the 1.5 times the AADD specified by the South African design guidelines ^e.

Sizing reservoirs according to fixed rules of thumb (for instance 48 hours of AADD) often results in reservoirs being significantly larger than required to ensure acceptable reliability.

8.4.1.2 Structure

The structure of a reservoir or water towers should have following components for proper functioning ^d:

- The ***inlet and outlet*** of a reservoir should be designed in such a way that water in the tank remains fully mixed, and that dead zones should be avoided ^f.
- A ***roof*** to prevent evaporation and contamination by bird droppings, rainwater and animals, and to keep the reservoir dark to prevent growth of algae.
- A mechanical or electronic ***water level indicator***.
- Inside and outside ***access ladders*** with cages to prevent falling.
- An ***access hatch*** in the roof that is hinged locked and won't let rainwater into the reservoir. Preferably two access hatches should be provided to allow workers inside the reservoir to escape in the case of an emergency.

- **Ventilation openings** fitted with insect-proof netting.
- **Lightning protection.**
- **Telemetry** to allow the reservoir level to be checked and pumps and valves operated remotely. The telemetry system should raise alarms for conditions such as the reservoir level being too high or low, and for unauthorised intrusion.
- An **overflow** to allow excess water to be released without damage to the structure or erosion of the soils surrounding the foundations. The overflow should be located in such a way that water flowing from it is visible from a distance.
- An **under-floor drainage layer** that is constructed in such a way that any leakage through the floor of the reservoir is directed to a visible outlet point where it can be observed.
- Reservoirs are sometimes provided with **compartments** that allows one half of the reservoir to be drained for maintenance or cleaning, while the other half is used to supply consumers. In such cases the reservoir pipework should be designed to allow each compartment of the reservoir to act independently.

8.4.1.3 Pipe work

The pipes transporting water to reservoirs and water towers, and from them to consumers normally have the following components^d:

- **Inlet pipes** supplying water to the reservoir or water tower from a source.
- If an upstream reservoir will be used to

supply consumers when the reservoir is taken out of operation, a **bypass valve and a PRV installation** (if applicable) should be provided.

- A **level control valve** on the inlet pipe that closes when the reservoir is full (to prevent water wastage due to overflows) and opens when its level drops.
- An **isolating valve on the inlet pipe** to allow the reservoir to be isolated.
- **Outlet pipes** supplying the distribution network (and thus users) from the reservoir or water tower. The entrances of outlet pipes should be raised above floor level to ensure that accumulated sediments are not washed into the system. Care should be taken that water hammer in a pumping inlet pipe cannot enter the distribution system through a bypass valve to the outlet pipe.
- **Isolating valves on all outlet pipes** as close as possible to the reservoir. This is important since a pipe burst between the reservoir and isolating valve cannot be isolated except by emptying the reservoir.
- **Water meters** on both inlet and outlet pipes.
- A **scour valve** with its entrance slightly below floor level to allow the reservoir or water tower to be emptied for maintenance purposes.
- The entrances of outlet and scour pipes may be **covered with steel grids** to prevent any large items that enter the reservoir accidentally or through vandalism from entering the pipes.

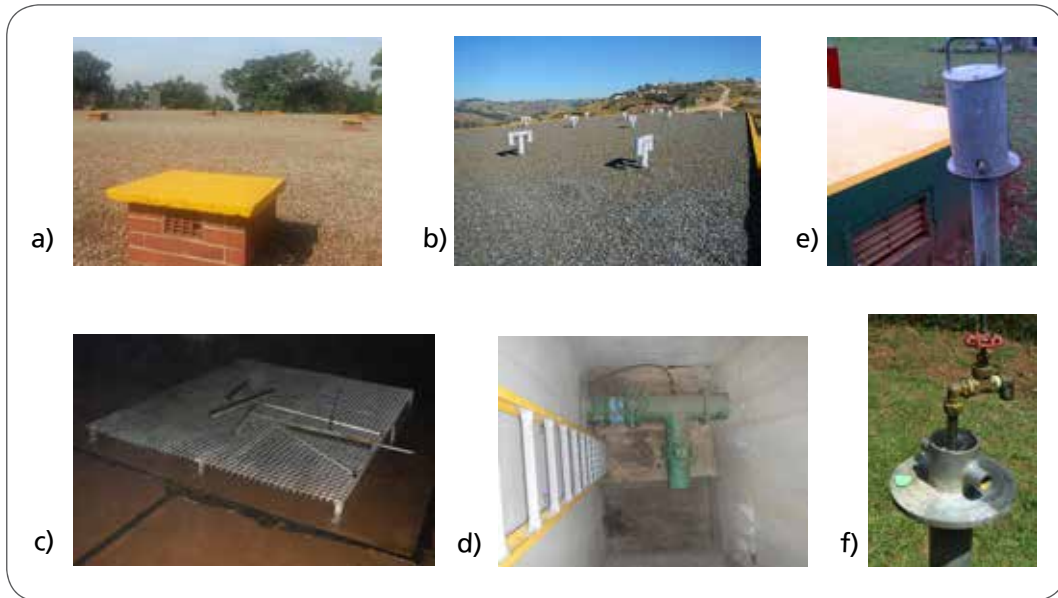

Figure 22 Examples of reservoir and water tower components: a) and b) reservoir roofs with air vents; c) grid over a reservoir outlet; d) reservoir scour valve; e) a water quality sampling point covered to protect it against contamination; f) an opened water quality sampling point.

- A **sampling point** to take water quality samples. The sampling point should be protected from contamination with a lockable cover.
- In some cases a **pump station** to transport water to a water tower or another reservoir.

8.4.1.4 Other

Other requirements for a reservoir or water tower include the following:

- A **perimeter fence** with a lockable access gate.
- A **sign with contact information** if members of the public notice any problems.
- A **sign that prohibits unauthorised access**.

- **Rainwater drainage** and protection to prevent contamination of the reservoir or erosion damage to the terrain.
- **Trees and shrubs should not be allowed** on reservoir and water tower terrains as their roots may cause damage to the structures.
- In some cases special **security measures**, such as such as intruder alarms and electrical fencing may be required.

8.4.2 Operation

The operational plan of a reservoir is normally not done in isolation, but in combination with other storage and pump facilities in the system. However, individual reservoirs should be operated based on the following:

- Reservoir operation is ***closely linked to energy costs*** since pumps are normally used to fill reservoirs. By pumping in the early morning hours, when electricity costs are at a minimum, and allowing the reservoir level to drop during the day, it is possible to minimize operational costs. A detailed analysis of the system and electricity tariffs is required to develop an optimal pumping schedule.
- The ***most critical time for reservoir reliability is during the summer peak*** demand period, where reservoir levels should be kept as high as possible and maintenance crews should be on standby to repair leaks on the reservoir feeder pipes as quickly as possible. The risk of a reservoir running dry is much lower during the winter months when the seasonal demand is lower, and it may even be considered to operate the reservoir at lower levels during these periods.
- Should reservoir retention times be so high that ***chlorine levels are at risk of being depleted*** in the system, a booster chlorination station should be installed on the reservoir inlet pipe.

8.4.3 Maintenance

Reservoirs and water towers need regular inspection and maintenance to keep them in good operating condition and prevent more serious problems from developing. Major maintenance on reservoirs and their pipework should be done during winter months when reservoirs have surplus capacity. Appendix B provides a checklist with required inspection and maintenance activi-

ties and their recommended frequencies. In all cases corrective action should be taken immediately when problems are discovered.

The ***weekly inspection*** and maintenance routine should include the following:

- ***Security fence, gate and lock and lighting.***
- ***Water meters*** for proper operation and leakage.
- ***Pump station*** for proper operation of pumps and other equipment (e.g. control valves or booster chlorinators),
- ***Pipework and reservoir*** for signs of leakage or reservoir overflow.
- Check that ***water level indicators*** function correctly.
- Cut grass and edges, and clean paths, channels and ***maintain gardens.***
- Take a ***water sample*** at the reservoir outlet and send for analysis.

The ***monthly inspection*** and maintenance routine should include the following:

- Open and inspect ***valve and meter*** chambers and other on-site installations for proper operation. Clean strainers and chambers. Check chamber lids and locks, and oil hinges.
- Check ***valves*** for corrosion or other damage, and that they are operating smoothly.
- Check ***lids/doors and locks*** on pump station, reservoir and other facilities and oil hinges.
- Check that ***signs*** are in place and legible.

- Take all *water meter readings* and compare inlet and outlet meters to look for signs of water losses. Note that differences in meter readings may be due to variations in reservoir levels between the readings.

Movable parts on valves should be greased every three months. Finally, reservoirs and water towers should be drained, cleaned, inspected and maintained every three to five years.

8.5 Common operation and maintenance tasks

8.5.1 Reservoir cleaning ^d

Reservoirs are mostly cleaned by staff entering the drained reservoir to remove accumulated sediments. During cleaning, consumers can be served from another reservoir or by a different part of the reservoir if it is sub-divided. Reservoir cleaning should be done during winter months when consumption, and thus the load on the reservoir, is at a minimum. In some cases, specially trained and certified divers may be used to clean the reservoir with special equipment without draining it. The steps required to clean the reservoir are as follows:

1. **Empty the reservoir.** The reservoir level should be allowed to drop as low as feasible by normal consumption. The valves on supply pipes are then closed and the scour valve opened to drain the remaining water.
2. **Collect accumulated sediments** from the bottom of the reservoir using spades, scrapers and brooms and remove it with buckets through the entry hatch. Alternatively the sediments may be liquefied using a high pressure spray and washed out through the scour valve. Special care should be taken not to damage linings that have been installed to waterproof the reservoir.
3. **Wash down the reservoir walls and floor** using a suitable detergent, high pressure spray and brooms. Use appropriate measures to reach higher parts of the walls and ensure that all joints and corners are properly cleaned.
4. **Rinse the walls and floor** using a high pressure spray until no traces of detergent are left in the rinse water.
5. **Inspect internal surfaces** and joints to ensure that all is in good condition. Do repairs if required.
6. **Disinfect** the reservoir as described in Section 8.5.2.

8.5.2 Disinfection

After construction, maintenance work or inspections where personnel enters a reservoir or water tower, the following disinfection procedure should be followed ^e:

1. **Ensure that the walls and floor of the reservoir are clean** and all traces of dirt and detergent washed out.
2. Ensure that the **scour valve is closed.**
3. **Prepare a solution** of water with a pH less than 7.5 (for optimal action of chlorine) and a chlorine concentration of 50 mg/l.

4. Thoroughly ***hose down all internal surfaces***, including pipe work and fittings with the chlorinated water.
 5. Some of the chlorinated water is poured or sprayed over the ***internal access ladder*** once all personnel have left the reservoir.
 6. The chlorinated water is ***drained from the structure through the scour valve***.
- Care should be taken to neutralise high chlorine content in the scour water where it can cause damage to the environment (for instance using sodium thiosulphate).
7. The structure is filled with potable water after a period of at least 6 hours.

Important points

- It is important to protect water in reservoirs from access by rodents, insects, sunlight and unauthorised persons.
- Reservoir pipework should be designed to keep reservoirs fully mixed in order to avoid dead zones.
- Reservoir sizes and water levels should be managed to minimize water retention time while ensuring adequate levels or reliability.
- Reservoir overflows and under-floor drainage should be visible to allow overflows or leakage to be observed.
- Water meters should be installed on reservoir outlets and inlets.
- Reservoir terrains should be kept neat, clean and free of bushes and trees.
- The most critical time for reservoir reliability is during the summer peak demand period. Maintenance crews should be on standby to address any problems experienced during this period, and routine maintenance should be done during the winter months when demand is at a minimum.
- Reservoirs should be cleaned every three to five years.

Additional Reading

The Operation and Maintenance Project of the Northern Cape, a partnership between several national and international bodies, produced the Water Supply Services O&M Handbook, a comprehensive and practical set of documents that can be of great use to municipalities in South Africa and other countries. It consists of a number of booklets, but the following booklet applies specifically to pumps:

x. O&M of reservoirs

This document may be obtained from Mr Kobus Streuders, Department of Water Affairs (Northern Cape), Private Bag X6101, Kimberley, 8300, Ph. 053 830 8800, Email streudersk@dwa.gov.za.

9.1 Introduction

Pumps are used to add energy to water in order to move it to a higher elevation, boost pressure or increase its flow rate. While different pump types exist, centrifugal pumps are almost exclusively used in water distribution systems. A brief overview of centrifugal pumps and their behaviour is given before discussing their operation and maintenance requirements.

9.2 Pumps

9.2.1 Introduction

Various different types of pumps are available, and they can be grouped into two categories: positive displacement and dynamic pumps. Positive displacement pumps move discrete ‘packets’ of water and are often used as dosing pumps in water treatment plants. Dynamic pumps produce a continuous stream of water through a rotating mechanism pushing the water

forward (similar to a boat propeller) or spinning it out using centrifugal forces. The latter type is called centrifugal pumps.

Centrifugal pumps are the most commonly used pump type in water distribution systems. They use enclosed spinning disks with curved vanes called impellers to generate centrifugal forces.

9.2.2 Characteristic curves of a centrifugal pump

The hydraulic properties of a centrifugal pump can be described with three curves, called the characteristic curves. These curves are called the head-flow, efficiency and NPSH (net positive suction head) curves respectively, and all three are plotted against the pump flow rate (see Figure 23). In many cases, the input power curve is provided in addition to, or instead of the efficiency curve. However, since it is possible to calculate the efficiency curve from the input power curve (and the other way round), only one of the two is required.

9.2.2.1 Head-flow curve

The energy transferred to the water by a centrifugal pump is used to increase both pressure and flow rate. However, if more of the energy is used to provide flow, less is available for pressure and thus the head-flow curve displays a reduction in pressure as the flow rate increases (see Figure 23 (a)).

If a valve on the downstream end of the

pump is closed, all the energy will be converted into pressure and the pump will deliver its maximum pressure head, called the shut-off head as shown in Figure 23 (a). Pumps are sometimes started against a closed valve, which is then slowly opened to prevent large water hammer from occurring. However, pumps should not be operated against a closed valve for long periods.

On the other extreme, if no delivery pipe is fitted and the water leaves the pump directly as a water jet, no pressure is generated and all the energy is converted to flow rate. This is the maximum flow rate the pump is able to deliver as shown in Figure 23 (a).

Neither of these extremes does useful work in a distribution system, and the desired operating point of a pump is always a combination of both pressure and flow. It is important to note that a given pump can only run on its pump curve, i.e. it can only produce the head and flow combinations shown on its head-flow curve.

9.2.2.2 Efficiency curve

The second characteristic curve of a centrifugal pump is its efficiency curve as shown in Figure 23 (b). The efficiency curve uses the same flow rate scale as the head-flow curve for its X-axis, and plots the efficiency of the pump on the Y-axis.

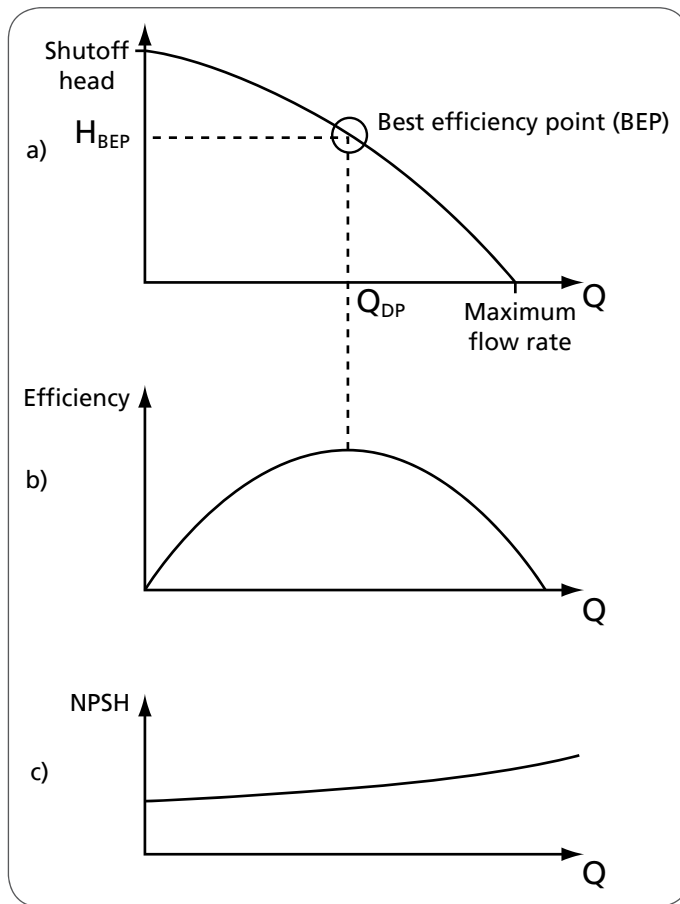

Figure 23 Typical characteristic curves of a centrifugal pump:

- a) H-Q curve,
- b) Efficiency curve and
- c) NPSH curve.

The efficiency curve uses the same flow rate scale as the head-flow curve for its X-axis, and plots the efficiency of the pump on the Y-axis.

The efficiency of the pump describes how much of the energy its motor receives from the electrical grid is converted to hydraulic energy. For example, an efficiency of 80 % means that if 100 kW of energy is taken from the electrical grid, 80 kW of energy is converted to hydraulic (flow and pressure) energy, while 20 kW is lost in the process - mostly through heat.

The cost of energy used by a pump over its service life is much more than the capital cost of the pump, and thus it is very important that the pump is operated at the best efficiency possible. It can be seen from Figure 23 (b) that the pump efficiency reaches a maximum value at a certain flow rate. This is called the best efficiency point, and every effort should be made to run the pump as close to this point as possible.

9.2.2.3 NPSH curve

The third characteristic curve of a centrifugal pump is called the NPSH curve. It also uses the same flow rate scale as the head-flow on its X-axis. On its Y-axis it gives the **required** NPSH (net positive suction head) of the pump. The **actual** NPSH of the pump is calculated with a formula and is affected by the suction pressure at the pump,

elevation above sea level and temperature of the water. The pump designer should confirm that the **actual** NPSH is always higher than the required NPSH to ensure that the pump will not experience cavitation.

9.2.3 System curve

Consider a system consisting of two reservoirs connected by a pipeline as shown in Figure 24. To pump water from the bottom to the top reservoir, energy is required to achieve three objectives:

- Lift the water to a higher elevation.
- Produce a velocity (and thus flow rate) in the pipe.
- Overcome the friction losses the water will experience as it moves through the pipe and fittings.

The height that the water has to be lifted is called the static head, and is simply the difference in elevation between the delivery and suction reservoir water levels. The other two components are both quadratic functions of the flow rate, meaning that they increase steeply as the flow rate in the pipe increases.

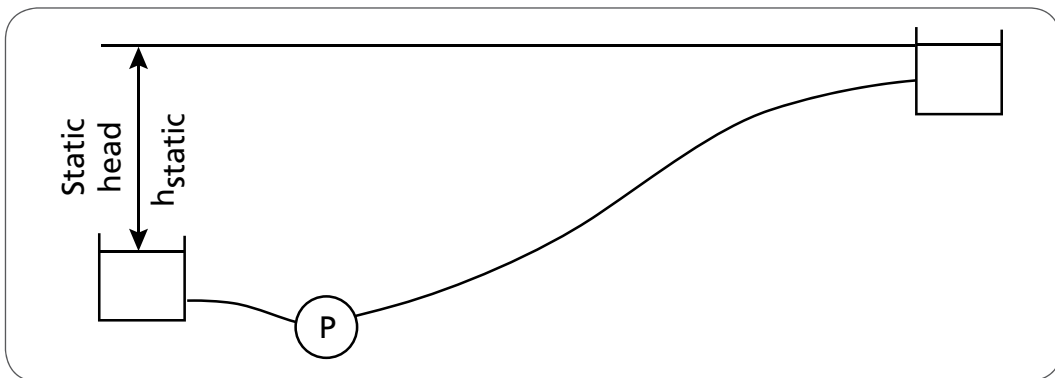

Figure 24 A simple pump system between two reservoirs.

A system curve is a curve of the pumping energy head required to move water from the bottom to the top reservoir for different flow rates as shown in Figure 25.

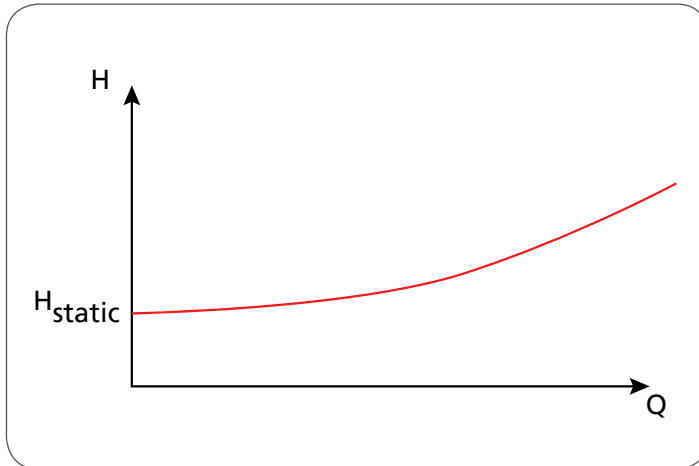

Figure 25 System curve for the system in Figure 24. It describes the required pumping head as a function of the flow rate.

It should be noted that the system curve would change if any of the system parameters changes. For instance, if the difference between the reservoirs water levels increases, the whole system curve will move up accordingly. If instead a valve is used to throttle the flow, the friction of the system will increase and the curve will rise at a steeper rate.

9.2.4 Duty point

To determine what will happen if the pump in Figure 23 is now installed in the system in Figure 24, the pump and system curves are plotted on the same axes as shown in Figure 26.

The only point where both the pump and system can operate is where the two lines

intersect. This is called the duty point of the pump. The efficiency and required NPSH of the pump can be read at the duty point flow rate as shown in Figure 26.

In a real system all operational conditions and their respective system curves should be considered to ensure that the pump would be able to operate under all operational conditions.

9.2.5 Pump selection

The challenge of the designer is to select a pump that is able to supply the required flow in the most efficient way. Besides the

large range of pump makes and models that can be chosen, other variables should also be considered, including the following:

- The **pump speed** can be increased or decreased to move the pump curve up or down respectively. This is normally done with a variable speed drive, although mechanical pump speed adjusters were mostly used in the past.
- Pumps may be **linked in series** as shown in Figure 27 (a) to increase the pressure that can be delivered. Pumps are mostly linked in series by using multistage pumps, in which more than one pump impeller is installed on the same shaft.
- Pumps may be **linked in parallel** as shown in Figure 27 (b) to increase the flow rate delivered and to provide operational flexibility and backup.

Figure 26 Pump and system curves showing the duty point and corresponding pump efficiency and NPSH requirement.

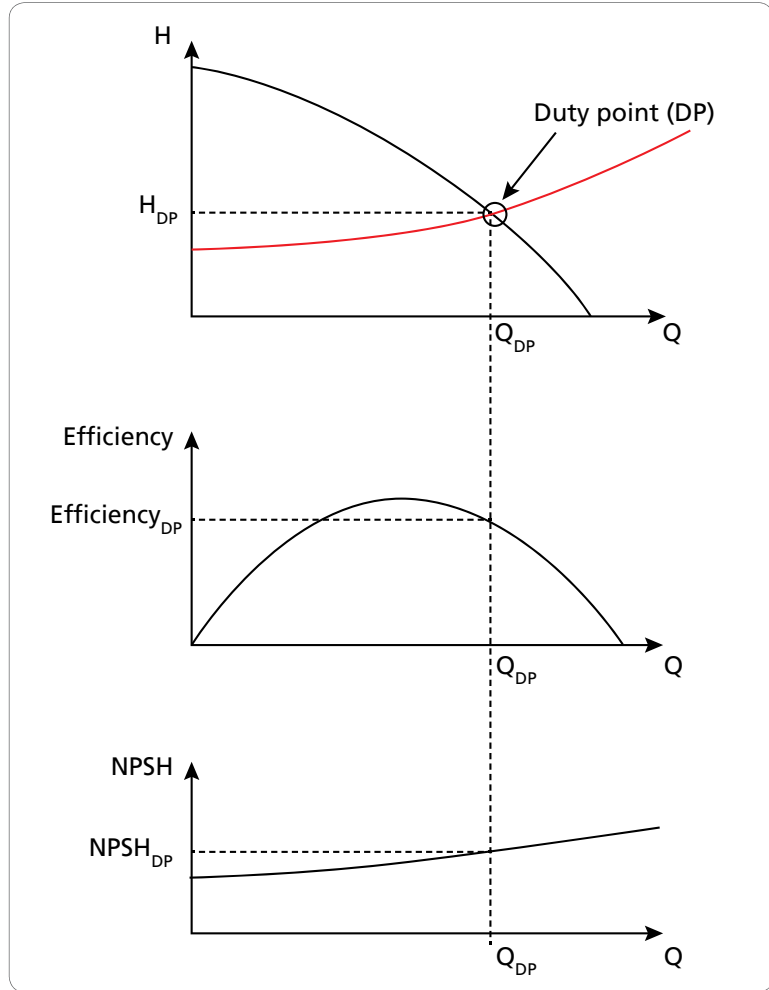

PUMPS

Figure 27 Pumps in a) series and b) parallel.

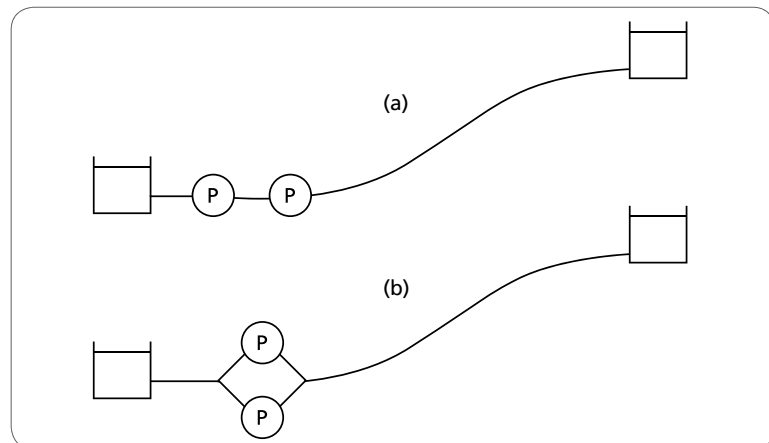

9.2.6 Pump drivers ^d

Pumps are mostly driven by electrical motors, but diesel engines are also sometimes used. Diesel motors have several disadvantages compared to electrical motors: their fuel has to be transported to and stored on site; they are less efficient, more expensive to operate and require substantially more maintenance. Diesel engines need regular replacement of air and fuel filters, as well as oil changes.

Electrical motors are substantially more economical to use than diesel engines, and require less maintenance. Thus they are preferred when an electric supply is available. The power consumption of an electrical motor is expressed in kilowatt (kW), and the quantity of energy consumed in kilowatt-hour (kWh). For instance, a pump using 10 kW of power and running for 8 hours will use a total of 80 kWh. Electricity consumption is charged per kWh unit, and may be more expensive during peak than off-peak periods.

Besides the consumption charge, electricity suppliers also have a charge that based on the maximum power consumed during a given month or year. This is called the capacity charge and is important when considering the starters used in electrically driven pumps. Electrical motors typically use six times the operating current when starting, although this may be reduced to 3.5 and 2.5 times by installing star-delta or soft starters respectively.

9.2.7 Pump energy cost

To manage pump operating costs, it is essential to understand the power rate structure used by the electricity provider. Some power utilities have time-of-day energy pricing, especially during peak energy consumption periods. This pricing can be accounted for by using the applicable energy price for each time period. Others use a block rate for which the unit price drops as the total power consumed increases. Still others use block rates that change based on overall electricity consumption patterns.

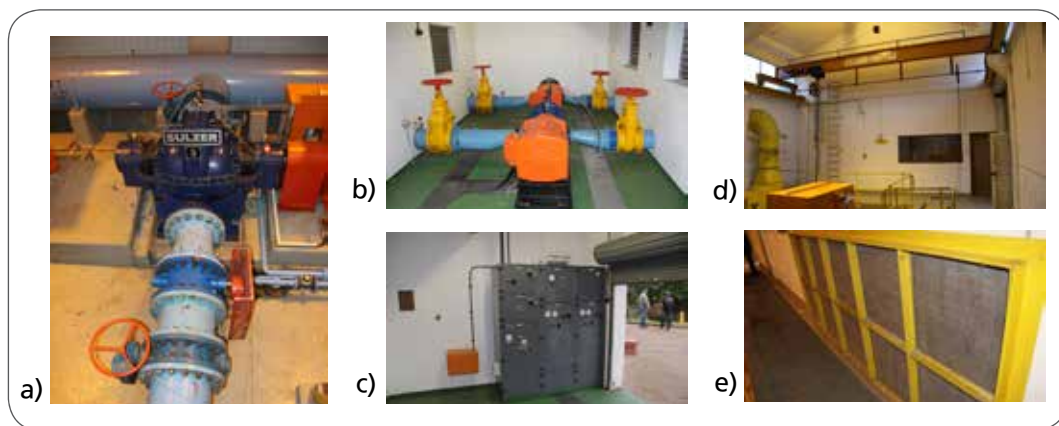

Figure 28 Examples of pump installations: a) centrifugal pump installation viewed from the delivery side b) centrifugal pump installation viewed from the side (electrical motors in front) showing the isolation valves on both sides and floor drainage; c) electrical switchgear and access door; d) crawl beam; e) air vents.

9.3 Operation and maintenance of pumps

9.3.1 Design and construction

The pump installation should incorporate a number of design features to facilitate operation and maintenance:

- **Correct pump selection** to ensure the pump is suitable for the application and that the best pumping efficiency is achieved.
- Ensure that **NPSH requirements are met**, since it is very expensive to fix NPSH problems on an existing pump installation, often requiring major work to construct a new pump station at a lower elevation.
- In general, pumps should be designed **not to operate for more than 18 hours per day**.
- The **maximum economical pumping line velocity** is normally around 1.8 m/s.
- **Backup pump capacity**. Pumps have to be stopped from time to time for routine maintenance or repairs, and thus it is important to provide backup pump capacity by using more than one pump in parallel. The simplest arrangement is to have two identical pumps in parallel, only using one of them at a time. This provides 100 % backup, which is considered high. A more economical solution may be to use three identical pumps in parallel, always running two of them at a time. This provides 50 % backup. Other backup arrangements are also possible.
- **Flexibility**. Pumping requirements are not fixed but may vary due to changes in reservoir water levels, changes in valve status, varying demands and increases in pipe roughness over time. The designer should ensure that the pump would run as close as possible to its best efficiency point under all expected operating conditions. A common way to achieve this is by installing variable speed drives on one or more pumps to allow the pump curve to be adjusted as required.
- **Allow for pump priming**. Centrifugal pumps cannot pump air effectively, and thus if a pump is installed above the suction water level, it may not be able to suck up water into the pipe to get the pumping process going. In order to pump, the suction pipe and pump will first have to be filled with water. This is called pump priming. Various methods are available for priming of pumps, such as special priming pumps or water tanks, or simply to install the pump below the suction water level.
- **Flow velocities should be limited** a maximum of about 1 m/s in the suction and 1.5 m/s in the delivery pipework to limit energy losses. The diameter of the suction pipe typically is larger than that of the delivery pipe.
- **Pump start and stop procedures** should be carefully considered and catered for in the design to minimise water hammer effects.
- The **potential for water hammer** caused by pump stops or starts should be considered and measures taken to minimise the impact of water hammer

on the system.

- If **bypass pipes** are installed around pumps, non-return valves should be installed on the bypass pipes.
- **Pumps and motor alignment** should be carefully done as part of the installation.
- **Distortion of the pump or motor casing** when its feet are bolted down on a slightly uneven surface (known as 'soft foot') should be avoided.

Pumps must always be installed in a pump house or pump station that should have the following components ^d:

- **Isolation valves** upstream and downstream of each pump to allow for its removal if required for servicing and repairs.
- **Eccentric and symmetrical reducers** respectively on the upstream and downstream sides of the pump. The reason for asymmetrical reducer on the upstream side is to prevent air from being trapped in the reducer and affecting the pump operation.
- A **non-return valve** on the downstream side of pump to protect it from water hammer pressures and prevent the pipeline from draining when the pumps are not in operation.
- An **air valve** at highest point on the downstream pipework.
- A **flow meter** on downstream side of the pump.
- **Pressure gauges** on both sides of the pump.
- **Telemetry** to allow the pump operation to be monitored and operated remotely. The telemetry system should raise alarms for conditions such as no-flow, high flow, abnormal temperatures, vibrations, unauthorised access and flood conditions (particularly when pumps are installed below ground level).
- **Lightning, surge and phase protection.**
- Good **ventilation with screens** to prevent animals entering the pump station.
- Good **security** to prevent unauthorised access.
- Adequate **space around the pumps** to allow them to be removed and maintained with ease.
- **Electrical cables** should be in neat cable trenches and not create a trip hazard. It is good practice to keep a laminated copy of the electrical switchgear of the pumps mounted in the station for easy reference.
- **Emergency stop controls** should be provided for all pumps.
- **Facilities to assist with removing the pump** from the pump station, including a crawl beam and large enough access doors to allow equipment to be loaded onto a vehicle.

The pump station terrain should comply with similar requirements as for reservoirs (see Section 8.1.4.1).

9.3.2 Operation

Pump energy consumption often represents

a major part of water supply operating costs, and thus it is important to ensure that pumps are operated as efficiently as possible. Many pump stations provide opportunities for cost savings by improving their operational parameters and schedules. Because so much energy is required for pumping, a savings of only few per cent can add up to substantial savings over the course of a year. Some stations operate as much as 20 to 30 % below their optimal efficiency ⁸.

Common operational problems that contribute to high energy use are:

- Pumps should be tested to determine their operational pump curve as soon as possible after commissioning, or when starting a new monitoring programme. Such measurements will take into consideration the actual pump operational conditions, and thus provide a benchmark to test the pump curve against as the pump ages.
- Pumps that are ***no longer pumping against their design head.***
- Pumps not running on their original curves due to ***deterioration of their impellers.***
- ***Variable-speed pumps*** being run at speeds that corresponds to inefficient operating points.
- ***Various pumps starting at the same time.*** This increases the maximum power used and thus has an important impact on the electricity capacity charge. It is advisable to stagger pump starting times to reduce the maximum electricity demand.

Where parallel pumps are used, the system should be operated in such a way that all pumps are regularly used, rather than keep the backup pumps for emergencies only. This will ensure that the backup pump remains in a good operational state.

Finally, a pump should never be throttled on its suction side as this can cause cavitation to occur in the pump.

9.3.3 Maintenance

Health and safety requirements are very important in pump stations, including not wearing loose clothing, preventing accidental contact with moving equipment, switching off electricity when working on electrical equipment, ear protection and ensuring that pumps are completely switched off (and cannot be switched on automatically) when working on them.

Backup power supply should be tested regularly to ensure that it is in good operating condition and starts up automatically. Backup engines should be run for at least one hour a month to lubricate all internal parts and ensure that batteries are fully charged. Switchgear on engines and generators should be checked regularly for correct operation.

The pump station floor, surfaces and control panels should be kept neat, clean and free from spills.

The following documents that explain maintenance requirements of centrifugal pumps and electrical motors are provided in Appendix B:

- Pump station ***weekly mainte-***

nance checklist

- Pump station ***monthly maintenance checklist***
- Pump station ***maintenance log***
- A checklist on the maintenance of diesel motors is also supplied in Appendix B.

9.4 Common operation and maintenance tasks

9.4.1 Checking pump operation

It is useful to check whether a pump is still operating on its original pump curve. To do this it is necessary that the flow rate through the pump and the pressures on both the suction and delivery sides are measured. Ensure that the flow meter and pressure gauges are in good condition and accurate.

Operate the pump and take readings on the flow meter as well as the two pressure gauges. Determine the pumping head by subtracting the suction pressure from the delivery pressure (if the suction pressure is a negative it will thus be added). Then plot the flow rate and delivery pressure on the pump's head-flow curve that should be on record, or can be obtained from manufacturers. If this point plots on or close to the original pump curve, the pump is still operating on its original curve.

It is possible to obtain a few points on the pump curve in this way by throttling a valve on the delivery side of the pump and then repeating the procedure above. If the power consumption of the pump motor can

be measured, the efficiency of the pump can also be calculated and plotted.

If the measured heads and flow rates do not plot close to the original pump curve, further investigations are warranted. A first step must be to verify that the flow and pressure meters give accurate readings. If the problem persists it may be necessary to service the pump or have the pump curve verified commercially.

If pump flow rate varies, for instance when used under different operational conditions or pumping directly into a supply area, the operating point of the pump should be determined under the different conditions. The different operational efficiencies can then be determined by plotting these points on the pump curve.

9.4.2 Common pump problems

Table 18 gives a useful description of common pump problems, possible causes and remedies, developed by the Southern African Pump Systems Development Association (SAPSDA, www.sapsda.co.za). Note that work on pumps can be very dangerous, and thus it is critically important to obtain and follow all applicable safety guidelines before doing any such work.

Table 18 Common pump problems, possible causes and remedies (SAPSDA, www.sapsda.co.za)

SYMPTOM	PROBABLE FAULT	REMEDY
Pump does not deliver liquid	Impeller rotating in wrong direction.	Reverse direction of rotation by swapping two phases on the electrical supply.
	Pump not properly primed -air or vapour lock in suction line.	Stop pump and reprime.
	Inlet of suction pipe insufficiently submerged and sucking a vortex in the water.	Increase suction depth of suction pipe to at least 3 x diameter of suction pipe.
	Air leaks in suction line or gland arrangement.	Make good any leaks or repack gland.
	Pump not up to rated speed.	Increase speed.
	Delivery/suction valve throttled or not fully opened or completely shut.	Check valve position.
Pump does not deliver rated quantity	Air or vapour lock in suction line.	Stop pump and reprime.
	Inlet of suction pipe insufficiently submerged and sucking a vortex in the water.	Increase suction depth of suction pipe to at least 3 x diameter of suction pipe.
	Pump not up to rated speed.	Increase speed by adjusting drive pulley ratios or use a variable speed drive.
	Air leaks in suction line or gland arrangement.	Make good any leaks or repack gland.
	Foot valve or suction strainer choked.	Clean foot valve or strainer.
	Restriction in delivery pipe work or pipe work incorrect.	Clear obstruction or rectify error in pipe work.
	Head underestimated and/or pump incorrectly selected.	Check head losses in delivery pipes, bends and valves, reduce losses as required or re-select pump to required delivery rate.
	Unobserved leak in delivery.	Examine pipe work and repair leak.
	Blockage in impeller or casing.	Remove half casing and clear obstruction.
Excessive wear at neck rings or wearing plates.	Dismantle pump and restore clearances to original dimensions.	

SYMPTOM	PROBABLE FAULT	REMEDY
	<p>Impeller damaged or vane angles not to specification.</p> <p>Pump gaskets leaking.</p> <p>Suction/delivery or non return valves faulty or not fully open.</p>	<p>Dismantle pump and renew impeller or re-machine vane angles.</p> <p>Renew defective gaskets.</p> <p>Check valves for defects replace if necessary.</p>
Pump does not generate its rated delivery pressure	<p>Impeller rotating in wrong direction.</p> <p>Pump not up to rated speed.</p> <p>Impeller neck rings worn excessively.</p> <p>Impeller damaged or choked.</p> <p>Pump gaskets leaking.</p>	<p>Reverse direction of rotation by swapping two phases on the electrical supply.</p> <p>Increase speed by adjusting drive pulley ratios or use a variable speed drive.</p> <p>Dismantle pump and restore clearances to original dimensions.</p> <p>Dismantle pump and renew impeller or clear blockage.</p> <p>Renew defective gaskets.</p>
Pump loses liquid after starting	<p>Suction line not fully primed - air or vapour lock in suction line.</p> <p>Inlet of suction pipe insufficiently submerged.</p> <p>Air leaks in suction line or gland arrangement.</p> <p>Liquid seal to gland arrangement lantern ring (if fitted) orifice choked.</p> <p>Lantern ring not properly located.</p>	<p>Stop pump and reprime.</p> <p>Increase suction depth of suction pipe to at least 3 x diameter of suction pipe.</p> <p>Make good any leaks or renew gland packing.</p> <p>Clean out liquid seal supply orifice.</p> <p>Unpack gland and relocate lantern ring under supply orifice.</p>
Pump overloads driving unit	<p>Pump gaskets leaking.</p> <p>Serious leak in delivery line, pump delivering more than its rated quantity.</p> <p>Speed too high.</p> <p>Bearings defective.</p>	<p>Renew defective gaskets.</p> <p>Repair leak or choke the pump with the delivery valve to ensure that it runs on its curve.</p> <p>Reduce speed.</p> <p>Replace bearing.</p>

SYMPTOM	PROBABLE FAULT	REMEDY
	Impeller neck rings worn excessively.	Dismantle pump and restore clearances to original dimensions.
	Gland packing too tight.	Stop pump, close delivery valve to relieve internal pressure on packing, slacken back the gland nuts and retighten to finger tightness.
	Impeller damaged.	Dismantle pump and renew impeller.
	Mechanical tightness at pump internal components.	Dismantle pump, check internal clearances and adjust as necessary.
	Pipe work exerting strain on pump.	Disconnect pipe work and realign to pump.
	Misalignment between drive and pump.	Align pump and drive.
	Pumping a product with a different density than what the pump was designed for (sludge vs water).	Check for what liquid the pump was designed for. Change the liquid product or change the pump.
Bearings wear	Pump and driving unit out of alignment.	Disconnect coupling and realign pump and driving unit.
	Rotating element shaft bent.	Replenish with correct grade of oil or drain down to correct level.
	Dirt in bearings.	Drain out bearing, flush through bearings; refill with correct grade of oil.
	Lack of lubrication.	Dismantle, clean out and flush through bearings; refill with correct grade of oil.
	Bearing badly installed.	Drain out bearing, flush through and refill with correct grade of oil. Determine cause of contamination and rectify.
	Pipe work exerting strain on pump.	Ensure that bearings are correctly bedded to their journals with the correct amount of oil clearance. Renew bearings if necessary.
	Deterioration of the oil lubricating properties due to ingress of dirt, moisture and excessive heat	Clean out old grease and repack with correct grade and amount of grease.
	Excessive vibration.	Disconnect pipe work and realign to pump.

SYMPTOM	PROBABLE FAULT	REMEDY
Excessive vibration	Air or vapour lock in suction.	Stop pump and reprime.
	Inlet of suction pipe insufficiently submerged.	Increase suction depth of suction pipe to at least 3 x diameter of suction pipe.
	Pump and driving unit incorrectly aligned.	Disconnect coupling and realign pump and driving unit.
	Worn or loose bearings.	Dismantle and renew bearings
	Impeller choked or damaged.	Dismantle pump and clear or renew impeller.
	Rotating element shaft bent.	Dismantle pump and straighten or renew shaft.
	Foundation not rigid or baseplate holding down bolts loose.	Remove pump, strengthen the foundation and reinstall pump. Tighten holding down bolts and fit lock nuts.
	Foundation/Pump plinth not large enough.	Foundation/pump plinth to be increased to roughly 5 x the weight of the pump and motor combination.
	Cavitation due to implosion of air bubbles.	Ensure that there is sufficient NPSH (Net Positive Suction Height) available. Bring the pump closer to the suction surface.
	Foundation/Pump plinth not wide enough.	Drop a vertical line from the center of the motor, two lines radiating out thirty degrees from this center-line should pass through the baseplate, not the sides of the foundation. Increase the width of the foundation.
	Coupling damaged.	Renew coupling.
	Harmonic vibration from nearby equipment.	The pump, or one of its components can vibrate in harmony with another piece of equipment located in close proximity. Isolate the vibration by installing vibration dampers.
Pipe work exerting strain on pump.	Disconnect pipe work and realign to pump.	
Shaft Alignment out.	Re-align.	

SYMPTOM	PROBABLE FAULT	REMEDY
Bearing overheating	Pump and driving unit out of alignment.	Disconnect coupling and realign pump and driving unit.
	Oil level too low or too high.	Replenish with correct grade of oil or drain down to correct level.
	Wrong grade of oil.	Drain out bearing, flush through bearings; refill with correct grade of oil.
	Dirt in bearings.	Dismantle, clean out and flush through bearings; refill with correct grade of oil.
	Moisture in oil.	Drain out bearing, flush through and refill with correct grade of oil. Determine cause of contamination and rectify.
	Bearings too tight.	Ensure that bearings are correctly bedded to their journals with the correct amount of oil clearance. Renew bearings if necessary .
	Too much grease in bearing.	Clean out old grease and repack with correct grade and amount of grease.
	Pipework exerting strain on pump.	Disconnect pipe work and realign to pump.
Irregular delivery	Air or vapour lock in suction line.	Stop pump and reprime.
	Fault in driving unit.	Examine driving unit and make good any defects.
	Air leaks in suction line or gland.	Make good any leaks or repack gland. arrangement.
	Inlet of suction pipe insufficiently immersed in liquid.	Increase suction depth of suction pipe to at least 3 x diameter of suction pipe.
	Suction inlet mesh blocked or dirty .	Clean suction inlet.
Excessive noise level	Air or vapour lock in suction line.	Stop pump and reprime.
	Inlet of suction pipe insufficiently submerged.	Increase suction depth of suction pipe to at least 3 x diameter of suction pipe.
	Air leaks in suction line or gland arrangement.	Make good any leaks or repack gland.

SYMPTOM	PROBABLE FAULT	REMEDY
	Pump and driving unit out of alignment.	Disconnect coupling and realign pump and driving unit.
	Worn or loose bearings.	Dismantle and renew bearings.
	Rotating element shaft bent.	Dismantle pump, straighten or renew shaft.
	Foundation or baseplate not rigid.	Remove pump and driving unit strengthen foundation.
	Cavitation due to pump not operating on it's designed duty point.	Throttle the pump delivery valve to force the pump back onto its operating curve. Select another pump to fit with the required duty.
	Waterhammer due to sudden pump stoppage. Sudden valve closure, etc.	Design pipeline and pump station components to minimize water hammer over pressures or release excess pressure to atmosphere by mechanical means.
	Mechanical seal arrangement has come loose from the pump shaft.	Stop the pump and replace the seat. Remachine pump shaft in case of serious damage.
	Mechanical seal faces are running dry causing a high pitched whistling noise.	Ensure that the pump is fully primed and avoid running the pump without water or fluid in the volute.
	The pump is being operated at a critical speed. (Any object made of an elastic material has a natural period of vibration. At the speed at which the centrifugal force exceeds the elastic restoring forcer the rotating element will vibrate as though it were seriously unbalanced - if it runs at that speed without restraining forces, the deflection will continue until the shaft fails.)	Avoid operation of the pump at the critical speed or ensure that there are sufficient restraining measures in place to deal with the unbalanced forces.

9.4.3 Common motor problems

Table 19 gives a useful description of common electrical pump motor problems, possible causes and remedies, developed by the Southern African Pump Systems

Development Association (SAPSDA, www.sapsda.co.za). Note that work on motors can be very dangerous, and thus it is critically important to obtain and follow all applicable safety guidelines before doing any such work.

Table 19 Common motor problems, possible causes and remedies (SAPSDA, www.sapsda.co.za)

SYMPTOM	PROBABLE FAULT	REMEDY
Bearing overheating	Pump and driving unit out of alignment.	Disconnect coupling and realign and driving unit.
	Oil level too low or too high.	Replenish with correct grade of oil or drain down to correct level.
	Wrong grade of oil.	Drain out bearing, flush through bearings, refill with correct grade of oil.
	Dirt in bearings.	Dismantle, clean out and flush through bearings. Refill with correct grade of oil.
	Moisture in oil.	Drain out bearing, flush through and refill with correct grade of oil. Determine cause of contamination and rectify.
	Bearings too tight.	Ensure that bearings are correctly bedded to their journals with the correct amount of oil clearance. Renew bearings if necessary.
	Too much grease in bearing.	Clean out old grease and repack with correct grade and amount of grease.
	Too much tension in chain or belt drive.	Reduce tension in chain or belt.
	Excessive end thrust.	Check motor if level, shim up. Reduce thrust from drive or machine. Shaft should have reasonable 'axial' float.
Bearings not greased regularly.	Motors fitted with greasable bearings should be greased at least weekly with an amount as prescribed by the manufacturer.	
Bearing wear rapidly	Pump and driving unit out of alignment.	Disconnect coupling and realign pump and driving unit. Renew bearings if necessary.
	Rotating element shaft bent.	Dismantle motor, straighten or renew shaft. Renew bearings if necessary.
	Dirt in bearings.	Ensure that only clean oil is used to replenish bearings. Renew bearings if necessary.

SYMPTOM	PROBABLE FAULT	REMEDY
	<p>Lack of lubrications.</p> <hr/> <p>Bearing badly installed.</p> <hr/> <p>Induced currents from variable speed drive.</p>	<p>Dismantle, clean out and flush through bearings; refill with correct grade of oil.</p> <hr/> <p>Ensure that bearings are correctly bedded to their journals with the correct amount of oil clearance. Renew bearings if necessary.</p> <hr/> <p>Some variable speed drive switch gear induce eddy currents in drive. the bearings causing the bearing to react like a capacitor. This causes arcing between the ball races and the bearing casing. This phenomenon can be prevented by using an in-line sine wave filter on the electrical supply or by installing ceramic bearings.</p>
Excessive vibration	<p>Pump and driving unit incorrectly aligned.</p> <hr/> <p>Worn or loose bearings.</p> <hr/> <p>Rotating element shaft bent.</p> <hr/> <p>Foundation not rigid.</p> <hr/> <p>Coupling damaged.</p> <hr/> <p>Mounting bolts not tight.</p>	<p>Disconnect the coupling set and realign pump and driving unit.</p> <hr/> <p>Dismantle and renew bearings.</p> <hr/> <p>Dismantle motor and straighten or renew shaft.</p> <hr/> <p>Remove motor, strengthen the foundation and reinstall motor.</p> <hr/> <p>Renew coupling.</p> <hr/> <p>Tighten mounting bolts and fit lock nuts to prevent them from loosening again.</p>
Motor overheating	<p>Motor incorrectly sized for duty.</p> <hr/> <p>Cooling air ducts/fan choked.</p> <hr/> <p>Cooling water system dirty/faulty or incoming water temperature too high.</p> <hr/> <p>Amps drawn too high due to under-voltage in supply.</p> <hr/> <p>General ventilation in plant room inadequate.</p>	<p>Check design requirements and replace motor if necessary.</p> <hr/> <p>Remove fan cowl and clean fan and ducting. On standard protected machines, it may be necessary to strip the motor and clean.</p> <hr/> <p>Investigate system, clean heat exchanger, supply water at correct temperature.</p> <hr/> <p>Check and rectify incoming supply.</p> <hr/> <p>Investigate and improve ventilation.</p>

SYMPTOM	PROBABLE FAULT	REMEDY
	<p>Overload, measure load and compare with name plate.</p> <hr/> <p>Rotor rubbing against stator.</p> <hr/> <p>Stator windings shorted.</p> <hr/> <p>Motor fan shear pin has failed allowing slippage.</p>	<p>Check for excessive friction in motor drive or machine. Reduce load or replace motor with right capacity motor drive.</p> <hr/> <p>Check bearings and replace if required.</p> <hr/> <p>Test windings with ammeter and repair/ correct</p> <hr/> <p>Open motor fan cover and replace shear pin. Check fan bush for damage and replace if necessary.</p>
Ammeter fluctuating during pump operation	<p>Incoming electrical supply inconsistent.</p> <hr/> <p>Loose connection in system.</p> <hr/> <p>Stator windings insulation breaking down.</p> <hr/> <p>On slipping motor brushes not contacting sliprings correctly.</p> <hr/> <p>Ammeter faulty.</p>	<p>Contact supply authority to rectify supply.</p> <hr/> <p>Check all connections in control panel, starters, terminal boxes.</p> <hr/> <p>Remove cable from motor terminal box and test windings and cable separately. Replace cable or have motor windings rectified by rewinding, re-insulation.</p> <hr/> <p>Expose sliprings and check and rectify brushes, brush holders, pressure springs.</p> <hr/> <p>Check and replace if necessary.</p>
Motor will not start	<p>Supply voltage not reaching motor.</p> <hr/> <p>Connections in system faulty or cable broken.</p> <hr/> <p>Motor incorrectly connected.</p> <hr/> <p>Motor incorrectly sized for application.</p> <hr/> <p>Starter contactor faulty.</p> <hr/> <p>Auto Transformer faulty.</p> <hr/> <p>Brushes not contacting slip rings correctly.</p> <hr/> <p>Internal connections in motor faulty.</p>	<p>Investigate and rectify.</p> <hr/> <p>Tighten and clean all connections and check cable for continuity.</p> <hr/> <p>Check connections against diagram.</p> <hr/> <p>Try starting motor uncoupled. Check sizing of motor to requirements of pump. If necessary change to motor more suited to requirements, i.e. high starting torque. etc.</p> <hr/> <p>Check and rectify.</p> <hr/> <p>Check and rectify.</p> <hr/> <p>Expose sliprings and check and rectify brushes, brush holders and pressure springs.</p> <hr/> <p>Check and rectify.</p>

SYMPTOM	PROBABLE FAULT	REMEDY
	Rotor resistance incorrect.	Check design and rectify rotor.
	Overloads in contactor incorrectly adjusted.	Check and reset to required value.
	Usually power supply problem - single phasing at starter perhaps a fuse has blown.	Check source of power supply.
Motor starts but will not take load	Overload incorrectly adjusted, or incorrect size of overload.	Check and reset to required value.
	Supply voltage incorrect.	Check and rectify.
	Loose connections in system.	Check and rectify.
	Motor incorrectly sized for duty.	Check and replace if necessary.
	Method of starting incorrect for duty requirement	Check design and rectify.
	Motor design incorrect.	Check design and rectify.
	Driven unit excessively stiff.	Check and rectify.
	Direction of rotation incorrect.	Check and rectify.
Excessive hum	Pump and driving unit out of alignment. Uneven air gap. Check with feeler gauge.	Replace bearings, check if rotor did not rubbed against stator.
	Winding fault, could be short circuit.	Inspect and test windings by an electrical re-winder.
	Rotor out of balance.	Dynamic balance rotor.

Important points

- Pumps should be provided with flow meters on their delivery sides, and pressure gauges on both sides to allow their pump curves to be measured.
- Pump efficiency is very important for operations costs, and thus pumps should be selected based on the best possible efficiency, and operated at their best operating points.
- It is very expensive to fix NPSH problems after a pump installation, and thus it is important that pump stations are designed in such a way that NPSH requirements are met.
- Backup pumps should be provided and regularly operated.
- The potential for water hammer should be investigated and appropriate steps taken to limit its impact if required.
- Pumps should be operated to minimize operational costs by staggering pump starts and pumping during low electricity demand periods.

Additional Reading

The Operation and Maintenance Project of the Northern Cape, a partnership between several national and international bodies, produced the Water Supply Services O&M Handbook, a comprehensive and practical set of documents that can be of great use to municipalities in South Africa and other countries. It consists of a number of booklets, but the following booklet applies specifically to pumps:

vi. O&M of pumps, drives and pump stations

This document may be obtained from Mr Kobus Streuders, Department of Water Affairs (Northern Cape), Private Bag X6101, Kimberley, 8300, Ph. 053 830 8800, Email streudersk@dwa.gov.za.

WATER

DISTRIBUTION SYSTEMS

10

10.1 Introduction

Water distribution systems consist of a large number of pipes and components connected in a network and functioning as a whole. While the operation and maintenance requirements of individual network components are discussed in chapters 6 to 9, this chapter deals with operation and maintenance on a system-wide level.

10.2 Water distribution networks

10.2.1 Introduction

Water distribution systems are difficult to analyse due to their many components, non-linear hydraulics and complex demand patterns. As a result, it computer network models are required to calculate flows and pressures in distribution systems. It is also important to measure flows and pressures in the network to monitor its behaviour, and identify potential problems early. This

section provides background on network hydraulics, computer models and measurement of flows and pressures in water distribution systems.

10.2.2 Network hydraulics

Water distribution systems are mostly supplied from water reservoirs located at high points above the supply areas, such as hills or water towers. Thus pressures and flows in the system are driven by gravity.

If there are no demands or leaks in the system, the water will be static and the pressure head at any point in the network will simply be the difference in elevation between the reservoir's water surface and the point. This is called the static pressure.

However, when a tap in the system is opened, the pressure in the system forces water out of the tap opening to supply it to the user. Similarly, when a system has leaks, water is forced out through the leak openings.

When water flows through the pipes from the reservoirs to the consumers and leaks, friction energy losses occur, which result in a reduction of pressure at any point in the system. The higher the demand in the system is, the greater the pressure losses will be.

From this explanation it should be clear that the system pressure would be at a maximum when consumer demand is at a minimum (typically between 3:00 and 4:00 in the morning). Conversely, when the demand in the system is at a maximum (typically between 6:00 and 7:00 in the morning), energy losses are at their highest and thus the pressures in the system

are at a minimum. The typical variation of demand and pressure in a system is shown in Figure 29.

When the pressures in the system become too low, the system is not able to supply the required flow rate and the system experiences a loss of hydraulic integrity. Design guidelines specify the minimum system pressure, which is typically 24 m'.

10.2.3 Hydraulic network models

It is very difficult to calculate the hydraulics (flows and pressures in the system) due to the size and complexity of the network layout, different operational conditions that

may occur (for instance pumps switching on and off, and reservoir or control valves opening and closing), as well as the complex hydraulic behaviour of water flowing through pipes and other components. For this reason, a hydraulic network model of the distribution system is an essential tool in the design and operation of water distribution systems.

Hydraulic network models require a lot of effort to set up, calibrate and maintain, but allow municipalities to predict the behaviour of the system under various conditions, such as future demand growth, valve closures, extensions and operational changes. It is essential that hydraulic models reflect the actual conditions in the field, and should thus be

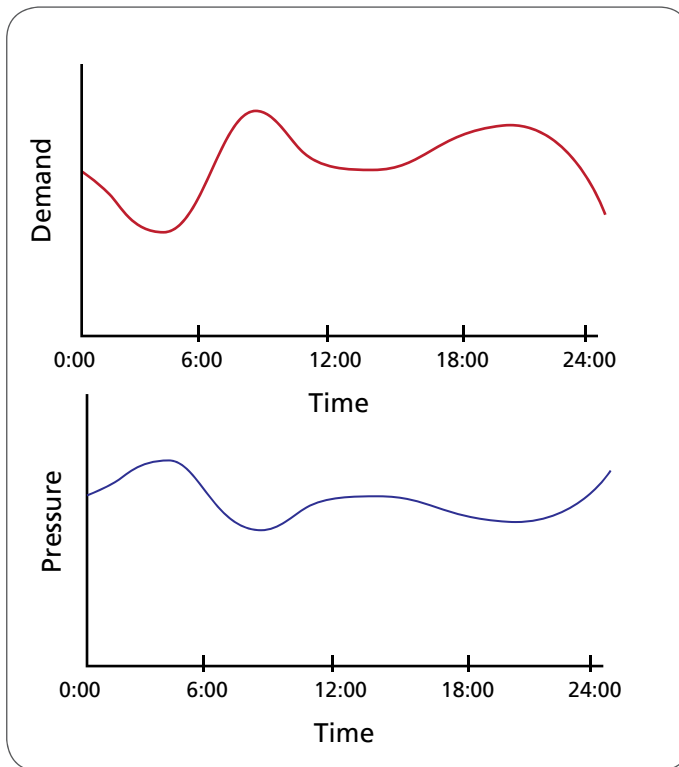

Figure 29 Typical variation of demands and pressure in a distribution system

calibrated against measured flows and pressures in the system.

10.2.4 Flow measurement

Water meters are essential in the management of water distribution systems, as they record the quantities of water that enters the system, how it is transported to different parts of the network and how much is delivered to consumers. There are four fundamental drivers for water metering in distribution systems:

- **Equity.** Consumer water meters form the basis for an equitable billing system based on the quantity of water used.
- **Water efficiency and losses.** By comparing the readings consumer water meters with the total system input volume, municipal engineers are able to estimate the level of water losses in a distribution system and identify illegal connections. Consumer meters can be used to focus the attention of users on their water consumption and encourage them to use it more efficiently.
- **Economic benefits.** Water meters form the basis of most municipal water bills, and thus have a direct impact on municipal revenues. Consumer water meters are sometimes called the cash registers of a municipality.
- **System management.** Water meters in the distribution system are essential to know how much water enters the system, where it is distributed too and what the losses in certain areas are. Water meters also play an essential role in calibrating hydraulic network models.

In South Africa, like many other countries, legislation requires municipalities to meter all consumers and monitor water losses in accordance with national standards. Water meters are used to sell water to consumers, and thus have to comply with strict accuracy requirements.

10.2.5 Pressure measurement

Pressure can be measured using a mechanical pressure gauge or an electronic pressure transducer, which converts the pressure reading to an electronic signal that can be logged or transmitted to a control room. Electronic pressure gauges are more versatile and are thus preferred. Pressure gauges should be selected based on the range of pressures expected at the measuring point. For instance, pressure gauges on the suction sides of pumps should sometimes be able to read negative pressures. Where hydraulic transient pressures need to be recorded, the pressure measuring equipment should be capable of taking readings at a rate that will record the full transient wave, and not just a few points on it.

Most important is that pressure gauges and transducers should be calibrated or verified before being put in use, and at regular intervals while in use. Errors in the pressure readings may cause difficulties when interpreting and using the data.

Pressures in a water distribution system are measured to monitor the level of service, but also to assist with leak detection and network model calibration. Pressure readings are invaluable when investigating the cause of network problems, especially if the readings are available in real time. Pressure readings are normally taken at pumps,

critical points in the network (i.e. lowest pressure points) and at points representing the average zonal pressure.

If pressure readings need to be taken for a short period of time only, a pressure gauge can be connected to a fire hydrant or tap. However, it is important to note that flow in the pipe between the pressure gauge and the intended measuring point on the distribution system will affect the pressure readings and should be avoided if possible. Unless they are close together, it is important to record the elevation of both the pipe and the pressure gauge, and to adjust the pressure reading to represent the system pressure. If the pressure gauge is higher than the pipe, the elevation difference between the gauge and pipe is added to the measured pressure head to get the correct pressure in the pipe.

10.3 Operation and maintenance of water distribution systems

10.3.1 Design requirements

Each component in a pipe network has to be designed or selected to function correctly under local conditions. However, these components function together as a unit in the network, and thus a failure of one component can affect other aspects of the system.

A network should be designed and constructed with operation and maintenance in mind. The following aspects should be considered:

- **Multiple sources.** A distribution

served from more than one source is inherently more reliable since the network will get water even if one of the sources fails.

- **Water demand patterns and growth.** Water demand tends to grow with time due to economic growth and densification, and thus the system should be designed for the demand at the design horizon, typically ten or twenty years into the future. In addition, water demand within any year is highly variable, especially in seasonal and diurnal patterns – consumers use more water in summer than in winter, and peak consumption typically occurs early in the morning when people get ready for the day. The pipe network should be designed to handle the diurnal peak demand during the seasonal peak demand period at the end of the design horizon.
- **A looped pipe layout** is better than a tree layout as this provides robustness in the system and reduces the risk of water stagnating. A network allows water to reach consumers via more than one route and thus is better able to maintain supply even when sections of the network are isolated for maintenance purposes.
- The **maximum allowable pressure in the system** should not be exceeded, particularly at night when there demand is at a minimum. The South African guideline for maximum pressure is 90 m, but it is highly recommended that the maximum pressure is kept as low as possible. Higher pressures cause pipe leaks to occur more frequently, pipe service lives to be reduced and the flow

rate from leaks to increase. It can also cause higher leakage on consumers' private plumbing systems, and result in higher levels of water wastage.

- The **minimum pressure in the system** that should be maintained even under peak demand conditions. The minimum pressure is 24 m in South Africa. It should be noted that in some cases users are located at such high elevations that it isn't possible to provide them with the minimum system pressure. This may still be acceptable if the pressures do not drop not too far below the minimum value, but ideally such developments should be avoided. Alternatively, the pressure for high-lying consumers can be improved by installing a water tower.
- **Minimum pipe velocities.** Pipes should regularly attain a velocity of at least 0.6 m/s and should not exceed a velocity of 1.2 m/s. However, it is often not possible to ensure that the minimum velocities are exceeded in pipes supplying only a few consumers. These pipes are more likely to accumulate sediments over time and will require regular flushing to avoid water quality problems.
- **A minimum pipe diameter** should be used in the system to ensure that there is adequate surplus capacity for high demands such as for fire fighting, and that the system is more robust. In addition, it is known that smaller diameter pipes have a higher frequency of failure and thus higher maintenance costs.
- **Limited pipe materials and diameters.** There are advantages to having a smaller number of pipe materials and diameters in a distribution system as this means that depots and maintenance crews need to carry less stock.
- **Suitable pipe materials** considering factors such as the chemical composition of the water, corrosive nature of soils, likelihood of stray currents and proximity to fuel depots to ensure that the pipes used are able to handle the system conditions.
- The **pipe class** determines the maximum operational pressure the system is able to handle. Ensure that this rated pipe pressure will never be exceeded, even in the case of a PRV or other system element failing.
- **Implement district metering areas (DMAs)** of around 2 000 users with similar elevations, preferably supplied through a single metered point where pressure can also be controlled if required. Steps should be taken to ensure that DMAs remain isolated from the rest of the network at all times. DMAs form the core of water loss and pressure management in a distribution system.
- **Water metering** should be done in accordance with a clearly defined strategy to ensure that the maximum benefit is obtained from the metering system. Water meters should be selected to have the correct size and the ability to handle the operating conditions in the system. Water meters should be installed strictly in accordance with manufacturer's requirements, including orientation.
- Use a **valve layout** in networks that allow sections of pipe to be isolated

with minimum impact on the rest of the network. Isolation valves should be installed so that not more than four valves need to be closed to isolate a pipe section of no longer than 600 m. However, the ideal is to have isolation valves at every branch at network nodes, so that only two valves are needed to isolate a pipe section. Bulk pipelines should have isolation valves every one to two kilometres.

- Use *different pipe materials or colours* when dual water distributions with both drinking and non-potable water are installed.
- **Reservoirs** should be located in such a way that pressures in the distribution system are adequate but not excessive. Reservoirs that are located too high require more pumping energy to fill and result in excessive pressures in the distribution system. Where a system has users at a large range of elevations, reservoirs should be installed at different elevations.
- In cases where large **water hammer** pressures may occur, for instance in large pumping lines, a water hammer analysis should be conducted and water hammer control measures implemented.
- Special measures should be taken to avoid pipe leaks in areas that have **dolomitic soils**, as leaks can lead to the formation of sinkholes that can cause major damage to buildings and services.
- Ensure that all **as-built drawings and GIS** information are correct.
- New pipes and components should be **pressure tested after installation** to

ensure that the construction was done correctly and is leak free.

10.3.2 Operation

Key system parameters should be continuously monitored to ensure that problems in the system are identified as quickly as possible. The following parameters should be monitored:

- **System input** flow rates from water treatment plants, bulk water suppliers and other municipalities, as well as water supplied to other municipalities. These flow rates are the largest in the system and thus accurate measurement is very important. Electromagnetic or ultrasonic flow meters are typically used and should be monitored continuously. The system input volume forms the basis for water loss estimation.
- **DMA meters** should also be monitored continuously and the results analysed for changes in consumption patterns and levels of leakage. Techniques are becoming available that can identify new bursts occurring in a DMA by analysing its consumption patterns. DMA consumption patterns are important in determining accurate water demand patterns for distribution system calibration and modelling.
- **Consumption meters.** Bulk consumers are the most important users of water in a municipality representing a high fraction of the total system demand. Their consumption monitoring should be given priority and should be done at least on a monthly basis, but more frequently if possible. Other consumer water meters should be read on a

monthly basis. Metered consumption should be analysed to identify patterns that may indicate defective meters, meter bypassing and on-site leakage.

- **System flow rates** are important for monitoring the movement of water in the distribution system and maintaining adequate reservoir water levels while ensuring that pumps are operated in the most efficient cost periods.
- **Water quality** should be monitored and corrective action taken immediately if problems are found.
- Information should be gathered from **pipe repair reports** on the type and likely cause of failures, as well as the condition of the distribution system at the failure. This information should be analysed annually to identify patterns and modify procedures if required.
- **Other aspects** of the network that should be monitored include galvanic protection, user complaints of pressure problems or strange tastes (that might indicate permeation occurring), pipe failures and pipe roughnesses.

Other operational requirements of water distribution systems include the following:

- **Operators** of the distribution system should be trained to correctly deal with situations that may potentially cause damage. For instance, if a pressure relief valve opens to protect the system from over-pressure after the failure of a PRV, the natural reaction of an operator may be to close the pressure relief valve, thus stopping it from fulfilling its protective function.
- **Maintenance staff** should be trained

to ensure that repairs are done correctly and safely, and cross-connections on parallel systems do not occur. For instance, valves should be opened or closed slowly to ensure that water hammer pressures are not generated. Pipe repairs provide an ideal opportunity to gather data on the state of the network and thus repair teams should be trained to complete reports on the state of the system as part of their maintenance tasks.

- Sudden **changes in velocity** should be avoided to prevent accumulated sediments from being suspended in the water.
- Fire services should use **soft couplings** to connect to the distribution system to prevent negative pressures being created by fire pumps.
- The **fire risk classification of areas** supplied should be investigated at least every three years, looking at all factors that affect fire risk and determining whether the fire risk classification remains the same or should be changed.
- **Water meters.** A database of all water meters should be developed and regularly updated. This database should include the reasons for meter failures and results of meter accuracy tests, and inform meter servicing, maintenance and replacement decision. Meters should be read on at least a monthly basis.

10.3.3 Maintenance

The following maintenance functions are important in water distribution systems:

- Adequate *quantities of network components* should be held in municipal stores for repair and replacement of pipes and other components.
- *Water meters* are subjected to wear and have finite service lives. Regular maintenance is important to ensure that water meters are able to function satisfactorily for as long as possible.
- The cost of maintaining pipes should be analysed and pipes *replaced or refurbished* when at come to the end of their economic service lives.

10.4 Common operational tasks

10.4.1 District metered areas (DMAs)

District metered areas are zones of a distribution system that are isolated from the rest of the system except for one (or sometimes more) supply points. All supply points are metered and sometimes also provided with PRVs to allow pressure management to be implemented in the DMA.

By monitoring the flow into a DMA, it is possible to analyse consumption patterns, and particularly the leakage in the system by measuring the minimum night flow. Once an allowance has been made for expected night-time consumption, the leakage in the system is obtained. Knowledge about the leakage levels in different DMAs allows a municipality to focus its leak detection efforts on those DMAs with the highest leakage rates. It also allows new leaks to be discovered soon after they appear.

It is important to check that DMAs are isolated from the rest of the system. This is done using a zero pressure test in which the supply to the network is closed and the network pressure monitored to check whether it reduces to zero (the DMA is isolated) or not (the DMA is connected to the rest of the system through an open valve or unknown connection).

Leaks in a DMA can be found by using a flow step-testing procedure during the minimum night flow period. This involves the systematic closure of valves to isolate sections of the network while continually monitoring the flow into the DMA. A sudden drop in flow when a section of the network is isolated is an indication that this section contains a major leak. Other methods, such as noise correlators can then be used to pinpoint the exact position of the leak. Step testing requires detailed maps of the DMA showing all pipes, valves and other components, as well as a pre-defined schedule for closing different valves in the system.

10.4.2 Pressure management

The International Water Association has been leading efforts on implementing pressure management in water distribution systems. Pressure management started as an effective technique to reduce leakage rates in distribution systems due to the fact that leakage is often quite sensitive to changes in system pressure. However, it is now recognised that pressure management has many other benefits for distribution systems, including lower pipe failure rates, longer pipe service lives and improved water demand management.

Where pressure zones experience pressures above the minimum level required, pressure management can be implemented without negatively affecting service levels. In some cases pressures can be reduced at all times of the day and night, while in others pressures are only reduced during the night.

To implement pressure management, a section of the network with similar elevations is isolated from the rest of the system and supplied through a single point (or sometimes more points) equipped with a water meter and PRV. These areas are called pressure management zones (PMZs) or pressure management areas (PMAs).

The PRV serving a pressure management zone can be controlled in four ways:

- **Fixed-outlet pressure control** is done using a standard PRV that limits the pressure on its outlet to a certain maximum value. This is a cost-effective and simple solution, but it does not have the ability to modulate pressure in response to the demand in the system, and thus pressures will still be higher at night than during the day.
- **Time-modulated pressure control** is done using a PRV similar to that of fixed-outlet control, but varies the pressure setting over a 24-hour period. Thus it is able to reduce pressures more during the night when demand is at a minimum. Time-modulated control is able to reduce leakage more than fixed-outlet control and is still relatively simple to implement.
- **Flow-modulated pressure control** is done by adjusting the PRV setting based on the flow rate into the PMZ and can thus adjust system pressure to

the actual demand. It is significantly more sophisticated than time-modulated control, but has the potential to reduce losses further. A major advantage of flow-modulated control is that the system is able to automatically respond when the fire service require high fire flows.

- **Closed-loop pressure control** is done by adjusting the PRV setting based on the pressure at a critical point in the PMZ, and thus has the best potential for maximizing the benefits of pressure management. However, these systems are also the most sophisticated and expensive.

A municipality should consider all the advantages and disadvantages of the different pressure controllers in light of its needs and capabilities to operate and maintain the system. The most sophisticated system is not necessarily the most appropriate one, and it is often possible to get substantial advantages by installing a simpler system.

10.4.3 Dealing with low pressure problems⁵

One of the most common problems experienced in water distribution systems is low system pressure, which is often discovered through complaints from consumers or routine pressure measurements.

If an individual consumer complains of low pressures, but the pressures in the supply pipes are normal, the problem may be due to a restriction in the consumer's plumbing system. However, if distribution systems pressures are low, it is advisable to monitor the pressures over at least a 24-hour period. If the pressure remains low throughout the monitoring period, the problem may

be caused by the consumer being at too high an elevation to supply with higher pressures, or as a result of a too low PRV setting. However, if the low pressures only occur during high demand periods, the problem may be caused by inadequate pipe capacity, a closed valve or even a blocked strainer.

If a calibrated network model exists, it can be used to model different potential causes in order to replicate the field conditions, and the most feasible causes can then be further investigated. A closed valve will normally cause a sudden drop in the hydraulic grade (i.e. the sum of the elevation and pressure head), and doing enough pressure measurements may thus show up a closed valve. To obtain a reliable picture of the hydraulic grade, it is important that both the pipe elevations and pressure measurements are accurately determined. Opening a hydrant to increase flow through the system will increase the drop in the hydraulic grade at a closed valve and may thus make it easier to find.

Finally, low pressures may be caused by a large leak in the affected area that increases system flow and thus reduces pressure. An analysis of the minimum night flow into the area can be used to confirm whether this is the case.

Once the cause of the low pressures is known, the solution is often straightforward and may include one of the following actions:

- Making operational changes such as opening closed valves
- Changing PRV or pump control settings

- Locating and repairing leaks
- Adjusting pressure zone boundaries
- Replacing pipes
- Cleaning and lining pipes
- Installing a booster pump
- Installing a new elevated tank to supply the affected area

10.4.4 Optimal pump scheduling⁵

It is possible to reduce operational costs of a distribution system by scheduling pumps to operate in such a way that they:

- Operate as close as possible to their best efficiency points.
- Operate during low electricity tariff periods.
- Reduce the peak electrical load.
- Pump against lower pressure heads.

It is important that changes to pump operating schedules should not compromise the system's ability to provide a reliable, high quality service. It is also important that accurate information on water demand patterns, pump and system curves, electricity tariff structures and minimum service levels are used in a pump scheduling analysis.

Once the pumps are checked and steps taken to operate them at maximum efficiency, further cost savings can be made by using the pumps to fill reservoirs during low cost electricity tariff periods, and allowing reservoir levels to drop during high electricity tariff periods. To ensure that the reliability of the system is not compromised, pumps should be switched on to fill reservoirs even during peak tariff periods

when they reach certain critical levels.

For a single pumping line, the optimal pump schedule is reasonably simple to find by considering different scenarios. However, systems with multiple pumps and/or reservoirs quickly become very complex to analyse, and optimisation algorithms or specialist software become necessary.

The general used to find the optimal pump scheduling are as follows:

- Build a **calibrated extended-period network model** that includes pump efficiency curves.
- Develop an **electricity cost model** based on the electricity price structure.

- Develop a system to ensure that **constraints** on reservoir water levels and system pressures are adhered to.
- Estimate **water demand patterns** for the period analysed.
- Run the **optimisation routine**.
- Check that the **results are reasonable**.
- Discuss the results with the system **operators**.

The last point is particularly important since operators often prefer to minimise the risk of reservoirs running dry by keeping them as full as possible, and they may resist efforts to allow reservoir levels to drop significantly.

Intermittent systems are failed systems!

It sometimes happen that water distribution systems provide water intermittently, in other words for only part of each day. This means that for the rest of the day pipes are drained of water and not under pressure, with devastating consequences to the integrity of the system.

Intermittent water distribution systems should never be considered as an option, but are in fact failed systems that are completely unable to provide consumers with clean and safe water, and the dignity that goes with it. Intermittent systems should be avoided at all cost!

Here are some of the consequences of intermittent water supply systems:

- **Complete loss of water quality integrity.** During periods where the network is not under pressure, contaminated water and soil enter the pipes through leak openings, resulting in the supply of unsafe water to consumers.
- **Inability to distribute water equitably.** Consumers in certain parts of the network are provided with high flows, while others get very little water.
- **Increased pipe failure rates.** Intermittent systems have been shown to have several times more burst rates and leakage than fully pressurised systems.
- **Increases water losses and wastage** due to greater failure rates and taps left open to collect as much water as possible during supply periods.
- **Loss of water metering systems** due to damage caused by particles entering the system and high air velocities that exceed maximum meter flow rates (and also register air flow falsely as consumption).
- **Loss of the ability to provide a reliable supply of water to fire services** to protect the community against fires.

Best practices for the operation and maintenance of water distribution systems.

The following points describing best practices in operation and maintenance of water distribution systems have been adapted from the Infraguide document Small System Operation and Maintenance Practices ²:

- Know and understand all **national and local regulations** applicable to the operation and maintenance of the water system.
- Get to know the water distribution system **assets and their locations**.
- Get to know the **condition** of the water distribution system.
- Determine **what is needed** to achieve the intended level of service.
- Develop a **plan to upgrade** inadequate components.
- Maintain an **adequate disinfection residual** in all parts of the system.
- Maintain **positive water pressures** under foreseeable operating conditions.
- **Monitor the quality of the water**. This includes water received from the treatment plant, in the distribution system and at the point of use (i.e., at the tap).
- Maintain comprehensive system **records and documents** reporting water quality.
- Ensure proper **disinfection and flushing procedures** are used for all repairs and new construction.
- Monitor for **internal and external corrosion** and, if necessary, implement measures to reduce the rate of corrosion.
- **Meter water supply and consumption** to quantify water losses from the system and, if necessary, implement a leak detection program.
- **Maintain** all pumping stations, water towers, reservoirs and chambers.
- Exercise and inspect the distribution system **valves and hydrants**.
- **Flush** water mains.
- Use a **maintenance management system and GIS**.
- Maintain a **spare parts inventory**.
- Prepare a **contingency plan** for emergencies.
- Prepare a plan to ensure the **financial sustainability** of the water system.

Additional Reading

Infraguide (2005) Small System Operation and Maintenance Practices, Federation of Canadian Municipalities and National Research Council, available from www.infraguide.ca.

Walski, T.M., Chase, D.V., Savic, D.A., Grayman, W., Beckwith, S., Koelle, E. (2003). Advanced Water Distribution Modeling and Management, Haestad Press, Waterbury, CT, USA.

Committee on Public Water Supply Distribution, National Research Council. (2006). Drinking Water Distribution Systems: Assessing and Reducing Risks. Washington, D.C.: National Academies Press.

Malcolm Farley, Icolm Farl (2003) Losses in Water Distribution Networks: A Practitioner's Guide to Assessment, Monitoring and Control, IWA Publishing.

Hamilton, S. and Charalambous, B. (2013) Leak detection – technology and implementation, IWA publishing, London.

REFERENCES



- a. Ahao, J., & Rajani, B. (2002). Construction and Rehabilitation Costs for Buried Pipe with a Focus on Trenchless Technologies. Report No IRC-RR-101. National Research Council Canada.
- b. Bannister, M. (2012) Asset management plan – ‘getting started’, Department of Water Affairs, Pretoria
- c. Byrne, R., Pietersen, J., Kumar, K., et al (2010) Taking a national approach to driving justified improvements in sustainable infrastructure asset management (SIAM) – A discussion paper designed to promote the adoption of a national municipal SIAM program in South Africa, Institute of Municipal Engineers of Southern Africa.
- d. Carlsson, B., Roux, J. (Editors) (2010) Water supply services O&M handbook, Department of Housing & Local Government, Northern Cape, and Department of Water Affairs & Forestry: Northern Cape Region.
- e. Chang C.-C., Van Zyl, J.E. (2014) “Optimal reliability-based design of bulk water supply systems”, *Journal of Water Resources Planning and Management*, 140 (1) 32 - 39
- f. Committee on Public Water Supply Distribution, National Research Council. (2006). *Drinking Water Distribution Systems: Assessing and Reducing Risks*. Washington, D.C.: National Academies Press.
- g. DWA (2011), *Water services infrastructure asset management strategy (WSIAM)*, Water services: policy and strategy, Department of Water Affairs, Pretoria, South Africa.
- h. FCMNRC. (2003). *Deterioration and inspection of water distribution systems - a best practice by the National Guide to Sustainable Municipal Infrastructure*. Retrieved 10 2012 from www.infraguide.gc.ca
- i. Hamilton, S. and Charalambous, B. (2013) *Leak detection – technology and implementation*, IWA publishing, London
- j. Infraguide (2003) *Potable water – developing a water distribution system renewal plan*, National guide to sustainable municipal infrastructure, NRC, Canada
- k. Lambert A; Brown T G; Takizawa M; Weimer D (1999) *A Review of Performance Indicators for Real Losses from Water Supply Systems*. AQUA
- l. Male, J.W. and T.M. Walski, 1990. *Water Distribution Systems – A Trouble Shooting Manual*.

- m. NGSi. (2003). Developing a Water Distribution System Renewal Plan. Retrieved 10 2012 from www.infraguide.ca
- n. NRC. (2004). Municipal Infrastructure Investment Planning, Report no B-5123.5. National Research Council Canada.
- o. SABS (2011) SANS 241: Drinking water, South African Bureau of Standards, Pretoria.
- p. Van Zyl, J.E. (2011). Introduction to Integrated Water Meter Management, ISBN 978-1-4312-0117-4, Report TT 490/11, Water Research Commission, Pretoria
- q. Van Zyl, J.E., Legat, Y., Piller, O., Walski T.M. (2012). "Impact of water demand parameters on the reliability of municipal storage tanks", *Journal of Water Resources Planning and Management*, **138** (5) 553–561.
- r. Lambert, A., Hirner, W. (2000) "Losses from water supply systems: Standard terminology and recommended performance measures", *International Water Association*. Available from http://www.iwahq.org/contentsuite/upload/iwa/all/Documents/Utilities/blue_pages_water_losses_2000.pdf.
- s. Van Zyl, J.E., Piller, O., Legat, Y. (2008). "Sizing municipal storage tanks based on reliability criteria", *Journal of Water Resources Planning and Management*, **134** (6) 548-555.
- t. Walski, T.M., Chase, D.V., Savic, D.A., Grayman, W., Beckwith, S., Koelle, E. (2003). *Advanced Water Distribution Modeling and Management*, Haestad Press, Waterbury, CT, USA
- u. CSIR. (2000). "Chapter 9: Water Supply (2003 revision)." *Guidelines for human settlement planning and design*, CSIR Building and Construction Technology, Pretoria.
- v. WHO (2008) *Guidelines for drinking-water quality*, World Health Organisation, www.who.int/water_sanitation_health/dwq/en/.
- w. Selvakumar, A., Clarck, R.M., Sivaganesan, M. (2002) Costs for water supply distribution system rehabilitation, *Journal of Water Resources Planning and Management*, **128** (4).
- x. Thompson, P., Majam, S. (2009) The development of a generic water safety plan for small community water supply, Report No. TT 415/09, Water Research Commission
- y. McKenzie, R.S., Wegelin, W., (2009), *Implementation of Pressure management in Municipal Water Supply Systems*, Available from http://www.miya-water.com/user_files/Data_and_Research/miyas_experts_articles/3_DMAs_Pressure_management/03_Implementation%20of%20pressure%20management%20in%20municipal%20water%20supply%20systems.pdf
- z. Infraguide (2005) *Small System Operation and Maintenance Practices*, Federation of Canadian Municipalities and National Research Council, available from www.infraguide.ca.

ORGANISATIONS

APPENDIX

A

Municipal Benchmarking Initiative

Website: www.munibench.co.za

Municipal Infrastructure Support Agent (MISA)

Department of Cooperative Governance

Website: www.cogta.gov.za

Phone (011) 100 3100

Water Support Centre

Website: www.watersupport.co.za

Phone 082 819 6862

South African Local Government Association (SALGA)

Website: www.salga.org.za

Phone (012) 369 8000

Department of Water Affairs Blue Drop System

Website: www.dwaf.gov.za

Phone (012) 336 6511

Institute of Municipal Engineering of Southern Africa (IMESA)

Website: www.imesa.org.za

Southern African Pump Systems Development Association (SAPSDA)

Website: www.sapsda.co.za

Phone 072 889 2789

Southern African Plastic Pipe Manufacturers Association (SAPPMA)

Website: www.sappma.co.za

Phone: (011) 314 4021

BULK CONSUMER WATER METER FIELD INVESTIGATION

General Information		
Details		
Customer name		
Account Number		
Suburb/Area		
Stand Number		
Street Name		
Street Number		
Time (with Reading)		
Inspection By		
Inspection By (Assist)		
Ref Number		
GPS ID		
GPS East Co-ord		
Photo Number		
Type of Business		
Fire Supply Metered	Y	N
Vacant Stand	Y	N

Installation detail		
Meter/s	Main Meter	
Size		
Make		
Date of Manufacture		
Serial Number		
Stand Number		
Factor		
Number of m ³ Digits		
Council Reading (m ³ only)		
Misaligned Numbers	Y	N
Legible Y/N	Y	N
Working Y/N	Y	N
Noisy Y/N	Y	N
Erratic Y/N	Y	N
Loggable Y/N	Y	N
Strainer/s Y/N	Y	N
Longitude Orientation	H	I
Lateral Orientation	H	I
Sub-Meter Y/N	Y	N

Comments and recommendations: _____

Installation drawing (with dimensions):

MAINS FAILURE, REPAIRS AND TEST PIECES REPORT

1. Locality: (Street number, Street name and suburb)

2. Locality sketch: (Indicate cross streets and north point.
Location of main from property boundary/Jkerb)

Date of burst:

Time of complaint

C3 Notification No

3. Description of repair (Briefly describe work done)

4. Pipe detail

4.1 Nominal size mm Outer diam mm Wall thickness mm

4.2 Type AC Steel CI uPVC Depth..... mm

4.3 Lining Nil Bitumen Cement

4.4 Sheathing Nil Bitumen Cement

4.5 Couplings Johnson Gibault Triplex Lead Push Home

5. Ground conditions

5.1 Position:- Carriageway Footway Verge Open ground

5.2 Surfaces:- Tarmac Concrete Ground water table Other

5.3 In situ ground:- Sand Sand Clay Soil/Stones Boilders

5.4 Backfill in trench:- Sand Clay Soil/stones Roots

6. Details of failure

6.1 Cause:- Crack Corrosion Joint Clamp Ferrule

6.2 If crack:- Circular Longitudinal Top Side Bottom

6.3 Was failure due to subsdnce? Yes No Was failure due to roots?

6.4 If damage by other party, (a) State name, (b) Foreman's name and contact details and (c) how damage occurred:-

7. Times: Reported to plumber On site Job complete

8. Plumber's signature: Date:

9. Superintendent's report: 9.1 Condition of site reinstatement:

9.2 Condition of pipe:

9.3 Site reinstatement notification no./Order no. Contractor: Date created:

9.4 Superintendant's signature: Date:

10. Depot Manager's report:

10.1 No. of properties affected: Other comments:

10.3 Depot Manager's signature: Date:

(Copies to be kept at depot and TOC (depot to fax to TOC))

RECOMMENDED MAINTENANCE INTERVALS FOR NETWORK COMPONENTS ^P

ITEM NO	MAINTENANCE ACTION	DAILY	WEEKLY	MONTHLY	ANNUALLY	OTHER
1	Pipelines					
1.1	Check for leakages in system (block by block)			√		
1.2	Check and clean chambers. Check chamber lock			√		
1.3	Take stock of spares (materials for pipe repairs)			√		
1.4	Flush entire system					√
1.5	Check marker posts and beacon				√	
1.6	Refurbish marker posts and beacons					√
2	Standpipes (communal and public buildings)					
2.1	Check for leakages	√				
2.2	Clean standpipe slab and surroundings		√			
2.3	Clean soak away		√			
2.4	Maintain standpipe equipment/accessories		√			
2.5	Read meters and clean meter chambers			√		
2.6	Replace biptap				√	
3	Bulk Meters					
3.1	Reading of bulk meters			√		
3.2	Cleaning of chambers			√		
3.3	Check for leakages			√		
3.4	Calibration of meters				√	
3.5	Replacement of registering unit					√
3.6	Replacement of entire meter					√
3.7	Check and empty all strainers protecting the bulk meters			√		
4	Consumer Meters					
4.1	Reading of meters			√		
4.2	Cleaning of meter chamber			√		
4.3	Check for leakages			√		
4.4	Check for tampering					√
4.5	Check meter accuracy					√
4.6	Replacement of entire meter					

ITEM NO	MAINTENANCE ACTION	DAILY	WEEKLY	MONTHLY	ANNUALLY	OTHER
5	Valves					
5.1	Open and close isolating valves		√			
5.2	Check functionality of scour valves		√			
5.3	Check functionality of air valves		√			
5.4	Check functionality of pressure reducing valve		√			
5.5	Service pressure management valves (pressure controllers) every two years					√
5.6	Maintain valve equipment/accessories				√	
5.7	Replacement of valves					√
5.8	Clean valve chambers. Check the cover lock		√			
6	Fire Hydrants					
6.1	Check for leakages		√			
6.2	Check and if required refurbish beacon/marker				√	
6.3	Check functionality of hydrants		√	√		
6.4	Test flow rate of hydrants				√	
6.5	Maintain hydrant equipment/accessories				√	
6.6	Replacement of fire hydrants					√
7	Record Keeping and reporting	√	√	√	√	

RESERVOIR CHECKLIST

Item	Frequency	Date and notes
Gate, gate lock and fence in good condition	Daily	
Water meters in running and in good condition	Daily	
Leaks on pipe routes	Daily	
Valve settings correct	Daily	
Leakage on reservoir outer walls	Daily	
Leakage from underfloor drainage	Daily	
Water level indicator working correctly	Weekly	
Grass cut, bushes removed and terrain clean	Weekly	
Water meter strainers cleaned	Monthly	
Take water meter readings	Monthly	
Chambers clean and in good condition.	Monthly	
Chamber lids oiled and locks in good condition	Monthly	
Exercise all valves	Monthly	
Valves cleaned and corrosion free	Monthly	
Signs on gate and fence clearly readable and in good condition	Monthly	
Check water quality	Monthly	
Grease movable parts on valves	Every three months	
Drain, clean and check reservoir	Annually	

WEEKLY MAINTENANCE CHECKLIST FOR PUMP STATIONS

Municipality: _____ Pump Station Name/No: _____

Monthly Schedule for: _____ Operator/Artisan: _____

	Checked		Remarks
	Yes	No	
1. Submersible Pumps			
1.1 Check for blockages and items snagged on impellor and remove			
1.2 Start the pump and check full load current			Full load current: _____ Amps:
1.3 Check pressure gauge readings			Delivery pressure: _____ kPa:
1.4 Lift pump and check operation of quick coupling (if fitted)			
1.5 Remove pump and clean off deposits with high pressure water jet (6 monthly)			
2. Centrifugal Pumps			
2.1 Check oil levels of the pump			
2.2 Check condition of the gland packing and adjust			
2.3 Check tightness of base plate mounting bolts			
2.4 Check pump for abnormal vibration			
2.5 Check pump for abnormal temperature			
2.6 Listen for any abnormal noises			
2.7 Start the pump and check for full load current			Full load current: _____ Amps:
2.8 Check pressure gauge readings			Delivery pressure: _____ kPa:
2.9 Check the alignment on the motor shaft-pump shaft coupling (monthly)			
2.10 Check the condition of the coupling, and coupling guard			
2.11 Check operation of the non-return valve			
2.12 Check operation of the motor cooling fan			
3. Electrical Switchgear			
3.1 Check operation of starters, contactors			
3.2 Check operation of over/under voltage protection mechanism			
3.3 Check operation of overload mechanism and circuit breakers			
3.4 Start the pump and check operation of ammeters and voltmeters			
3.5 Check proper operation of all panel lamps			
3.6 Check operation of overhead lighting			
3.7 Check operation of sump level control system			
3.8 Check operation of telemetry system (if fitted)			
3.9 Check condition of electrical motor bearings			

Operator/Artisan on Duty: _____ Signature: _____

MONTHLY MAINTENANCE CHECKLIST FOR PUMP STATIONS

Municipality: _____ Pump Station Name/No: _____

Weekly Schedule for Week: _____ To Week: _____ Operator/Artisan: _____

	Checked		Remarks
	Yes	No	
1. Submersible Pumps			
1.1 Check for blockages and items snagged on impellor and remove			
1.2 Start the pump and check full load current			Full load current: Amps:
1.3 Check pressure gauge readings			Delivery pressure: kPa:
1.4 Lift pump and check operation of quick coupling (If fitted)			
1.5 Remove pump and clean off deposits with high pressure water jet (6 monthly)			
1.6 Check oil levels and condition of oil. Replace if milky in colour			
2. Centrifugal Pumps			
2.1 Check oil levels of the pump			
2.2 Check condition of the gland packing and adjust			
2.3 Check tightness of base plate mounting bolts			
2.4 Check pump for abnormal vibration			
2.5 Check pump for abnormal temperature			
2.6 Listen for any abnormal noises			
2.7 Start tile pump and check for full load current			Full load current: Amps:
2.8 Check pressure gauge readings			Delivery pressure: kPa:
2.9 Check the alignment on the motor shaft-pump shaft coupling (monthly)			
2.10 Check the condition of the coupling, and coupling guard			
2.11 Check operation of the non-return valve			
2.12 Check operation of the motor cooling fan			
2.13 Grease oil pump bearings			
3. Electrical Switchgear			
3.1 Check operation of starters, contactors			
3.2 Check operation of over/under voltage protection mechanism			
3.3 Check operation of overload mechanism and circuit breakers			
3.4 Start the pump and check operation of ammeters and voltmeters			
3.5 Check proper operation of all panel lamps			
3.6 Check operation of overhead lighting			
3.7 Check operation of sump level control system			
3.8 Check operation of telemetry system (if fitted)			
3.9 Check condition of electrical motor bearings			
3.10 Wash down all switchgear enclosures with a wet cloth			
3.11 Blow out all dust and insects from inside of panel with blower			
3.12 Remove and dean all contactors using a suitable solvent			
3.13 Tighten all cable glands			
3.14 Check that all cables in racks and conduits are secure			
3.15 Check all terminals for integrity and corrosion			
3.16 Check ultrasonic level sensor settings and clean sensor face			
3.17 Check and tighten all electric motor terminals			
3.18 Grease all motor bearings			
3.19 Check all earthing systems and lightning arrestors for correct operation			

Operator/Artisan on Duty: _____ Signature: _____

DIESEL ENGINE PUMP MAINTENANCE CHECKLIST

PROCEDURE \ INTERVAL	8 HOURS	250 HOURS	500 HOURS	1 000 HOURS	2 500 HOURS
Check fuel tank level	✓				
Check coolant level	✓	✓	✓	✓	✓
Check drive belts		✓	✓	✓	✓
Clean fuel pump strainer			✓	✓	✓
Empty water trap	✓	✓	✓	✓	✓
Replace fuel filter element			✓	✓	✓
Check injector tips for atomization					✓
Check and adjust idle speed					✓
Check lubricating oil level		✓	✓		
Check lubrication oil pressure gauge	✓	✓	✓	✓	✓
Replace lubricating oil		✓	✓	✓	✓
Replace lubricating oil filter		✓	✓	✓	✓
Clean engine breather vent valve					✓
Clean air filter element		✓	✓	✓	✓
Replace air filter element				✓	✓
Clean turbocharger lubricating drain pipes					✓
Check condition of the exhaust and silencer				✓	✓
Check and adjust the valve tip clearances					✓
Check alternator, starter motor, etc					✓
Clean starter battery terminals		✓	✓	✓	✓
Check battery electrolyte levels and top up		✓	✓	✓	✓

Introduction to Operation and Maintenance of Water Distribution Systems

Professor JE (Kobus) van Zyl holds Bachelor and Master's degrees in Civil Engineering, and a Diploma in Scientific Computing from the University of Johannesburg, and obtained a Ph.D. in Civil Engineering at the University of Exeter in 2001. He was Chair of the Department of Civil Engineering Science and held the Rand Water Chair in Water Utilisation at the University of Johannesburg before joining UCT in 2009. He is currently the Assistant Dean for Academic Development in the Faculty of Engineering and the Built Environment.

Prof van Zyl is a registered Professional Engineer, a member of the South African Society of Civil Engineering, American Society of Civil Engineers and the International Water Association, and a Fellow of the Water Institute of Southern Africa. In 2008 he chaired the 10th Water Distribution System Analysis (WDSA) Conference, held in the Kruger National Park under the auspices of the American Society of Civil Engineers. This was the first time a WDSA conference had been held outside the USA.

Prof van Zyl has twice been awarded the Best Paper prize in the Journal of the South African Society for Civil Engineering. He is an Associate Editor of the Journal of Water Resources Planning and Management, and a member of the Editorial Board of the Urban Water Journal.

Prof van Zyl's research focuses on water distribution systems, and his current interests include hydraulic modelling, impact of pressure on leakage, reliability of bulk supply systems and water demand management.

