



Swimming Pool Operators Course

Environmental Health

Job#1710



northern health

the northern way of caring

TABLE OF CONTENTS

INTRODUCTION 1

- Prevention of Harm..... 1
- Outbreaks, Injuries and Chemical Mishaps 2
- Course Outline 3

PHYSICAL TREATMENT 4

- Part 1: Pool Recirculation..... 4
 - A. Turnover Rates 4
 - How to Determine Turnover Rate.....5
 - 1. Calculating Pool Volumes5
 - 2. Flow Rate7
 - B. Recirculation Equipment 7
 - 1. General Recirculation Pattern.....7
 - 2. Skimmers8
 - 3. Overflow Gutters10
 - 4. The Main Drain11
 - 5. Hair and Lint Strainer13
 - 6. Recirculation Pump13
 - 7. Filters.....15
 - 8. Flow Meter16
 - 9. Water Heater and Heat Exchangers16
 - 10. Chemical Feeders and Automation.....18
 - C. Summary - Physical Treatment: Pool Recirculation 22
 - D. Review Questions: Physical Treatment: Pool Recirculation 23
- Part 2: Filtration 24
 - A. Concept of Filtration..... 24
 - 1. Turbidity24
 - 2. Turbidity Standard.....24
 - 3. Backwashing.....24
 - B. Types of Filters..... 25
 - 1. Sand Filters.....25
 - 2. Non Permanent Media Filters34
 - 3. Cartridge Filters.....39
 - C. Summary - Physical Treatment: Filtration 41
 - D. Review Questions: Physical Treatment: Filtration 42

CHEMICAL BALANCE 43

- Part 1: pH Control..... 43
 - A. Theory of Acid Base Chemistry 43
 - B. pH 43
 - 1. pH Determinants.....44
 - 2. Importance of pH Control.....45
 - 3. Requirement for pH.....46
 - 4. Control of pH.....46
 - 5. Effect of Temperature on pH.....47
 - C. Summary - Chemical Balance: pH Control 47
 - D. Review Questions: Chemical Balance: pH Control 48

Part 2: Total Alkalinity And Calcium Hardness 49

- A. Total Alkalinity 49
 - 1. The Relationship Between pH and Alkalinity49
 - 2. The Ideal Range for Total Alkalinity.....49
 - 3. Problems Total Alkalinity Can Cause in Pools49
 - 4. Effect of Cyanuric Acid on Total Alkalinity50
 - 5. Lowering Total Alkalinity51
 - 6. Raising Total Alkalinity53
- B. Calcium Hardness..... 53
 - 1. The Ideal Range for Calcium Hardness53
 - 2. Problems Calcium Hardness Can Cause in Pools.....53
 - 3. Adjusting Calcium Hardness53
- C. Langelier’s Saturation Index 54
- D. Total Dissolved Solids..... 56
- E. Test Kits 56
- F. Summary - Chemical Balances: Total Alkalinity and Calcium Hardness..... 57
- G. Review Questions: Chemical Balance: Total Alkalinity and Calcium Hardness..... 58

BIOLOGICALLY SAFE POOL WATER 59

Part 1: Water Disinfection 59

- A. Requirement for Disinfectant Levels in Pool Water 59
- B. Bacteriological Water Sample Analysis 59
 - 1. Unsatisfactory Water Sample Results.....60
 - 2. Proper Sampling Technique61
- C. The Theory of Chlorination..... 62
 - 1. The Effect of pH on Chlorine Effectiveness.....62
 - 2. Chlorine disinfection terminology62
 - 3. Shocking64
 - 4. Superchlorination64
 - 5. Basic Formula for Chlorinating65
 - 6. Dechlorination66
- D. Summary - Biologically Safe Pool Water: Water Disinfection..... 68
- E. Review Questions: Biologically Safe Pool Water: Water Disinfection 69

Part 2: Types Of Disinfectants 70

- A. Unstabilized Chlorines..... 70
 - 1. Gas Chlorine70
 - 2. Calcium Hypochlorite.....73
 - 3. Sodium Hypochlorite.....77
 - 4. Lithium Hypochlorite78
 - 5. Salt Generated Chlorine.....79
- B. Stabilized Chlorine 81
 - 1. Stabilized Chlorine Compounds81
 - 2. Cyanuric Acid (CYA).....82
 - 3. Testing for Cyanuric Acid83
- C. Bromine83
- D. Supplemental Disinfectants.84
 - 1. Ozone.....85
 - 2. Chlorine Dioxide88
 - 3. Ultraviolet Light (UV) Disinfection89
- E. Summary - Biologically Safe Pool Water: Types of Disinfectants 90
- F. Review Questions: Biologically Safe Pool Water: Types of Disinfectants..... 91

MAINTENANCE AND TROUBLESHOOTING 92

- A. Other Chemicals 92
 - 1. Non-Chlorine Shock 92
 - 2. Flocculants and Coagulants 93
 - 3. Algaecides 94
 - 4. Sequestering Agents 94
 - 5. Degreasers 95
 - 6. Defoamers 95
 - 7. Biguanides 95
- B. Regulatory Requirements 95
 - 1. Permits 96
 - 2. Changes or Modifications to the Pool 96
 - 3. Recordkeeping 96
 - 4. Written Policies 97
 - 5. Pool Maintenance 100
 - 6. Rental Hot Tubs 101
- C. Whirlpools 101
 - 1. Whirlpools Bather Load: The Significance 102
 - 2. Emergency Shut-off 103
 - 3. Clock 103
 - 4. Thermostat Control 103
- D. Safety Equipment 104
 - 1. Emergency phone 104
 - 2. Lifesaving Equipment 104
 - 3. First Aid Kit 105
 - 4. Shower Temperature Control 105
- E. Summary - Pool Maintenance and Regulatory Requirements 106
- F. Review Questions: Pool Maintenance and Regulatory Requirements 107

Glossary of Terms 108

Appendix A - Defecation Control Strategies for Swimming Pools 110

Appendix B - Instructions for Sampling Pool Water for Bacteria 111

Appendix C (1) - Tables for Adjusting Total Alkalinity 112

Appendix C (2) - Tables for Adjusting Total Alkalinity 113

Appendix D - Pseudomonas Aeruginosa Information Sheet 114

Appendix E - Total Alkalinity Adjustment Required 116

Appendix F - Maintenance Checklist 117

Appendix G - Troubleshooting 118

Appendix H - Conversion Factors 123

SWIMMING POOL OPERATORS COURSE

INTRODUCTION

For fun, fitness and relaxation, swimming is a popular activity. Due to our geography and climate, much swimming done by residents of and visitors occurs in swimming pools. Pool patrons expect to have an enjoyable experience in a clean and safe facility. However, if a pool is not designed and maintained properly, bathers are at risk of serious injury and disease.

The BC Swimming Pool, Spray Pool and Wading Pool Regulations (hereafter referred to as “the Regulation”) states that:

‘Every swimming pool shall be operated and maintained by a competent operator and Manager. The Ministry of Health may require a certificate of competency obtained through attendance and successful completion of an approved swimming pool operator’s training course as evidence of compliance with this section.

The responsible person for a pool must ensure that the pool is operated and maintained by a qualified person trained in pool operation, water chemistry, pool filtration and maintenance. This course is designed to assist pool operators in meeting the training requirements as set out in the regulation.

PREVENTION OF HARM

Pools that are not constructed or maintained properly may lead to serious consequences for the patrons. Lives have been lost in pools with cloudy water where bathers in trouble could not be seen. Pool patrons have died or have been severely injured due to poorly designed or inadequately maintained pool equipment. Something as simple as a missing drain cover has caused the death of a child at a swimming pool. Numerous cases and outbreaks of disease have been associated with pools that have inadequate disinfection and cleaning procedures.

Pool water can easily become contaminated by harmful microbiological organisms (pathogens) carried into the pool by the bathers themselves. Various studies have shown the average swimmer releases about 200 billion bacteria during a swim. The organisms can be shed from the skin, nose, mouth, urinary tract and the intestinal tract. Not all are harmful, but the pathogens can cause diseases, including:

- skin infections such as athlete’s foot, plantar warts and rashes,
- eye and ear infections such as pink eye and swimmer’s ear,
- respiratory infections ranging from the common cold to Legionnaire’s disease,
- diarrheal illnesses such as cryptosporidiosis, norovirus and shigellosis.

Persons responsible for pools must be aware of the conditions within their facilities that can lead to injuries and disease. They must take all precautions to limit the possibility of their pool patrons being harmed. Training in safe pool operations is a necessity.

OUTBREAKS, INJURIES AND CHEMICAL MISHAPS

Unfortunately, sometimes things go wrong in and around pools which can have an impact on human health. Listed below are some local, national and international incidents that have occurred over the years:

- 2006 Quebec** – 7 year old boy had lower legs amputated after getting caught in waterslide park pump.
- 2006 Illinois** – 45 cases of Legionnaire’s disease from a hotel’s pools.
- 2005 Lake Louise** – chemical gas incident at a hotel – inexperienced employee used an acid bucket for sodium hypochlorite and toxic gas was formed. Emergency services were called, the hotel was evacuated and three people were hospitalized.
- 2005 Canmore** – chemical gas incident at a hotel – employee poured acid into the sodium hypochlorite bin and toxic gas was formed. Emergency services were called and the employee was treated in hospital.
- 2005 New York** state – 4076 cases of cryptosporidium at a spraypark.
- 2005 Kentucky and Ohio** – at least 200 confirmed & probable cases of cryptosporidium associated with region pools.
- 2005 Australia** – 180 cases of cryptosporidium linked to pools.
- 2004 BC** – E. coli outbreak in about 10 kids, linked to waterpark.
- 2003 Surrey, BC** – 33 cases of cryptosporidium – 31 direct exposure, 2 due to secondary spread. At least one employee worked throughout symptomatic period.
- 2003 Kansas** – about 600 ill with cryptosporidium from pools.
- 2001 Manitoba** – 59 cases of cryptosporidium associated with hotel pool.
- 2001 Medicine Hat, AB** – cryptosporidium – 38 cases linked to area pools.
- 1998 Australia** - > 1000 cases of cryptosporidium linked to pools.
- 1991 Winnipeg** - 12 year old girl drowns in whirlpool because her hair got caught in an improper whirlpool fitting.

COURSE OUTLINE

The course is divided into sections. First, the physical cleanliness of the pool water will be discussed. The construction of the pool enclosure, the pool circulation system and the filtration equipment all play a role in keeping the water clear.

Next, the **chemical balance** of the pool water must be maintained. The chemistry of the water, including the pH and alkalinity, must be kept within optimal limits. If not, bathers may experience discomfort, the disinfection procedures may be adversely affected and the pool basin and equipment may break down.

Microbiological safety is an important component of this course. Pool disinfection systems must be maintained to help prevent the illnesses associated with the use of pools. Special procedures must be followed in circumstances when the pool water or facility has become contaminated.

Furthermore, a pool should have **written policies** covering:

- safety and supervision of the public,
- posting of rules and education of bathers,
- response to water quality issues,
- a general sanitation plan.

A knowledgeable and conscientious pool operator is the best line of defence in preventing swimmers from being harmed in a pool environment. Local health officials are available to assist in ensuring that pools are being maintained to prevent injury and disease. Ultimately, though, it is the responsibility of the pool owner and the trained pool operator to ensure bathers enjoy the fun, fitness and relaxation they seek while swimming.

PHYSICAL TREATMENT

PART 1: POOL RECIRCULATION

Pool water must be circulated through filters and other pool equipment in order to keep it physically clean. The Regulation requires that pool water be taken from the overflow gutters or skimmers and the main drain, then filtered and treated before being returned through inlets back to the pool. The circulation system must be designed to encourage water mixing and prevent areas in the pool where water does not move, so called 'dead spots', from occurring.

A. Turnover Rates

When an amount of water equal to the total volume of the pool has moved through the recirculation system, it is called a **turnover**. The time it takes for the total volume of water to circulate once through the recirculation system is called the **turnover period**. The **turnover rate** is a measure of the amount of water moving through the recirculation system in a 24 hour period of time.

POOL TYPE	OPTIMUM TURNOVER RATE
Swimming Pool - New	4 hours (6 turnovers/day)
Whirlpool less than 4000 litres	15 minutes
Whirlpool 4000 litres and greater	20 minutes
Water slide receiving pool	1.5 hours
Water Spray Park (recirculating)	2 hours
Wading Pool (recirculating)	2 hours

When clean water comes to the pool from the filter, it dilutes the pool water making the whole pool somewhat less turbid. Initially, if four turnovers per day are accomplished, approximately two days are necessary to remove 98% of suspended matter.

A pool operator needs to know the required turnover rate in order to determine how to properly size and operate the recirculation pump so that the water flows fast enough to meet the required turnover period.

How to Determine Turnover Rate

To calculate the turnover rate the following information is required:

- a. The pool volume, or number of litres of water in the pool; and
- b. The number of turnovers required per day.

Turnover rate = volume of pool x # of required turnovers/day

For example, an existing swimming pool is known to have a volume of 100,000 litres. This pool only has 4 turnovers per day (6hr).

$$\text{Turnover rate} = 100,000 \text{ litres} \times 4 \text{ turnovers/day}$$

$$\text{Turnover rate} = 400,000 \text{ litres/day}$$

Note: For conversion of metric to Imperial measurements, please see Appendix H.

1. Calculating Pool Volumes

If the pool volume is not known, calculations can be done to determine it. For pools with a square or circular pattern, the following formulas may be used. To determine the volume of an irregular shaped pool, an operator may have to consult the manufacturer.

Please note that the calculated volume of the pool may not be exact, as the level of water may vary and some water exists in the circulation system. The calculated water volume will be close enough for the purpose of operating the pool when you follow the information contained in the pool manual.

a. Rectangular Pool with Constant Depth

$$\text{Volume (V)} = \text{Length (L)} \times \text{Width (W)} \times \text{Depth (D)}$$

$$V = L \times W \times D$$

b. Rectangular Pool with Variable Depth

(Use this formula for each section of depth and add together)

$$V = L \times W \times \frac{D1 + D2}{2}$$

c. Circular Pool with Constant Depth

$$V = R^2 \times 3.14 \times D$$

R = Radius

1 Cubic Metre (m³) = 1000 Litres (220 Gallons)

1 Cubic Foot (ft³) = 6.24 Gallons (28.37 Litres)

Example: Determining Turnover Rate in a Swimming Pool with Variable Depth

Pool shape is:

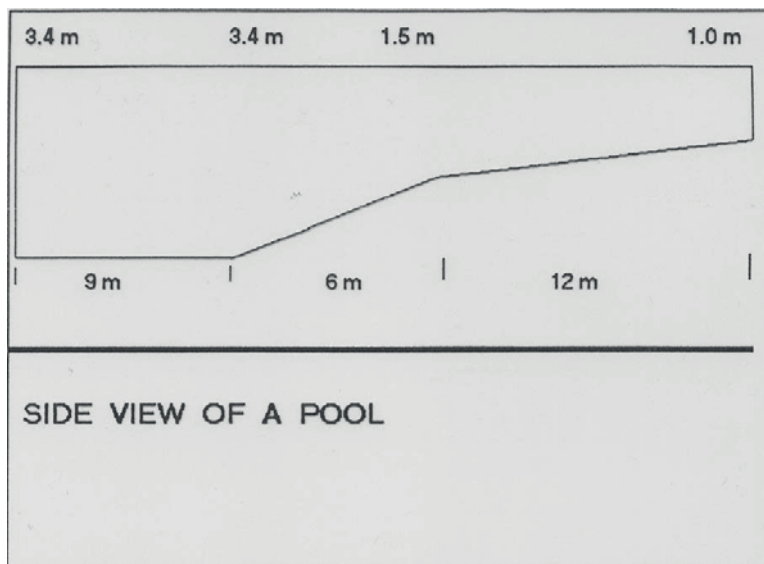

In this example, the pool width is 15 metres.

To Determine Pool Volume

Shallow end $\frac{12 \text{ m} \times 15 \text{ m} \times 1 \text{ m} + 1.5 \text{ m}}{2} = 225 \text{ m}^3$

Middle section $\frac{6 \text{ m} \times 15 \text{ m} \times 1.5 \text{ m} + 3.4 \text{ m}}{2} = 220.5 \text{ m}^3$

Deep end $9 \text{ m} \times 15 \text{ m} \times 3.4 \text{ m} = 459 \text{ m}^3$

Total $225 \text{ m}^3 + 220.5 \text{ m}^3 + 459 \text{ m}^3 = 904.5 \text{ m}^3$

$1 \text{ m}^3 = 1000 \text{ L}$

$904.5 \text{ m}^3 \times 1000 \text{ L/m}^3$

$= 904\,500 \text{ L in the pool}$

To Determine Turnover Rate

$$\begin{aligned}\text{Turnover Rate} &= \text{volume} \times \# \text{ of required turnovers/day} \\ &= 904\,500 \text{ L} \times 4/\text{day} \\ &= 3\,618\,000 \text{ L are required to go through the recirculation system} \\ &\quad \text{each day}\end{aligned}$$

2. Flow Rate

The **flow rate** is a measure of the water volume passing through the recirculation system over a period of time. It is usually measured in litres per minute (L/min) or gallons per minute (gal/min). The flow rate is monitored by the flow meter (which will be discussed in more detail later). Pool operators must ensure that the observed flow rate meets the turnover requirement.

To Determine Flow Rate

$$\begin{aligned}\text{Flow Rate} &= \frac{\text{Turnover Rate}/(24 \text{ hours/day}) \times (60 \text{ min/hour})}{3\,618\,000 \text{ L/day} (24 \text{ hours/day}) \times (60 \text{ min/hour})} \\ &= \frac{3\,618\,000 \text{ L}}{1440 \text{ min}} \\ &= 2512.5 \text{ L/min}\end{aligned}$$

This pool's recirculation system must be designed to operate at 2500 litres per minute. This is what the minimum flow meter reading should be for this pool in order to meet the requirement of 4 turnovers per day.

B. Recirculation Equipment

1. General Recirculation Pattern

A good working knowledge of your pool equipment and performing regular maintenance is needed to maintain a safe and well-operated pool. Swimming pool operators must be familiar with all equipment in the pool facility. A flow chart diagram is an excellent guide and can be posted in the equipment room.

All equipment should be clearly identified. Water lines should be identified to determine the direction of water flow. In an equipment room where more than one pool system exists, the

different systems must be clearly identified. Color coding or labelling of lines is a convenient method of identification.

Diagram: General Recirculation

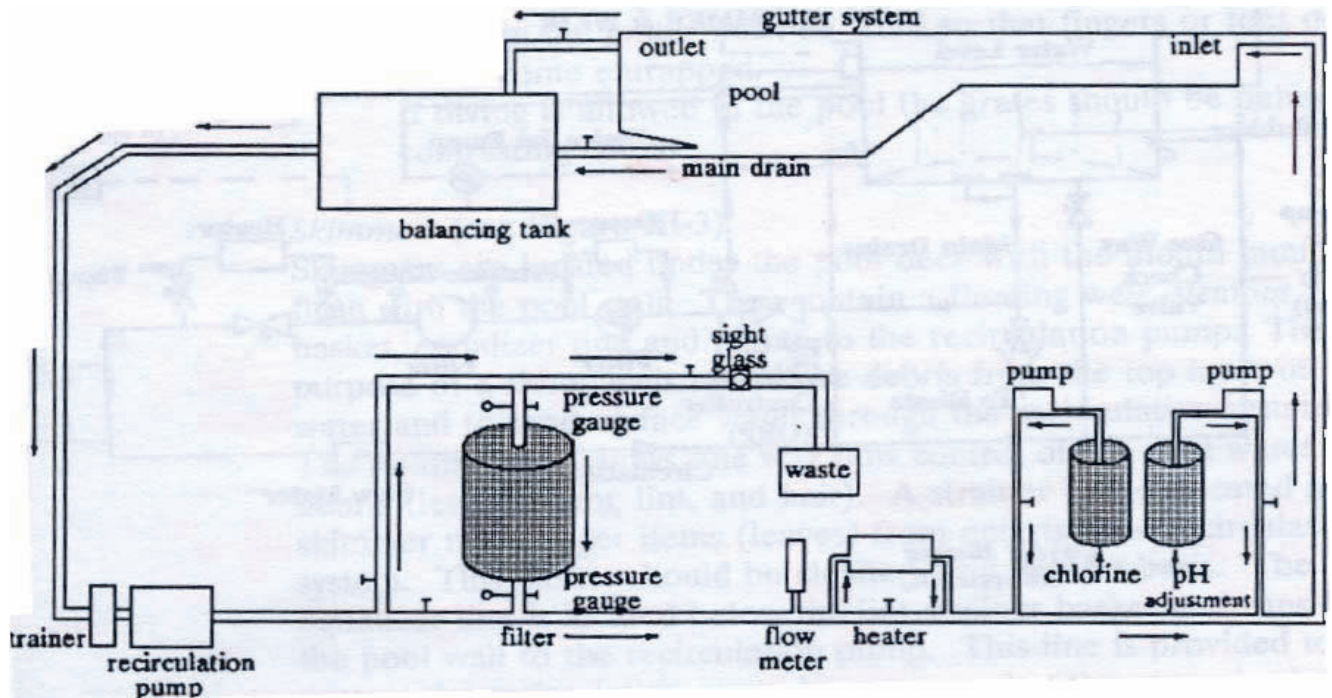

2. Skimmers

Skimmers are located under the pool deck at the water level. The mouth of the skimmer is flush with the pool wall. The purpose of skimmers is to remove water from the pool surface for recirculation and filtration. This will also remove body oils, hair, etc. that float on the surface. To remove the maximum contaminant load, 80% of water that is being recirculated should flow through the skimming devices when the pool is being used.

A **floating weir** is required in a skimmer. This device allows only one way flow from the pool into the skimmer so that scum, lint, hair, leaves, etc. cannot flow back into the pool. Floating weirs, which usually look like a gate hinged at the bottom of the skimmer opening, operate best when they are floating at a 45 degree angle. The water level needs to be constant to ensure the proper angle is maintained. Water levels can be affected by bathers entering the pool. This is especially true for smaller pools or whirlpools. An automatic water

levelling device may be required if water levels fluctuate greatly in order to keep the water at the optimal level.

Another type of weir that can be used is a floating ring that sits inside the skimmer.

A **strainer basket**, also known as a leaf basket, is provided in the skimmer to stop debris from entering the recirculation line. This strainer basket should be cleaned on a regular basis.

An **equalizer line** is provided on skimmers to protect the recirculation pump. The line ensures that the pump is always sucking water and not air. When the pool water level is too low (below the floating weir), the valves on the equalizer line open and allow water to flow through to the recirculation line.

The equalizer line may be located in the main drain to prevent an entrapment hazard.

Diagram: Skimmer

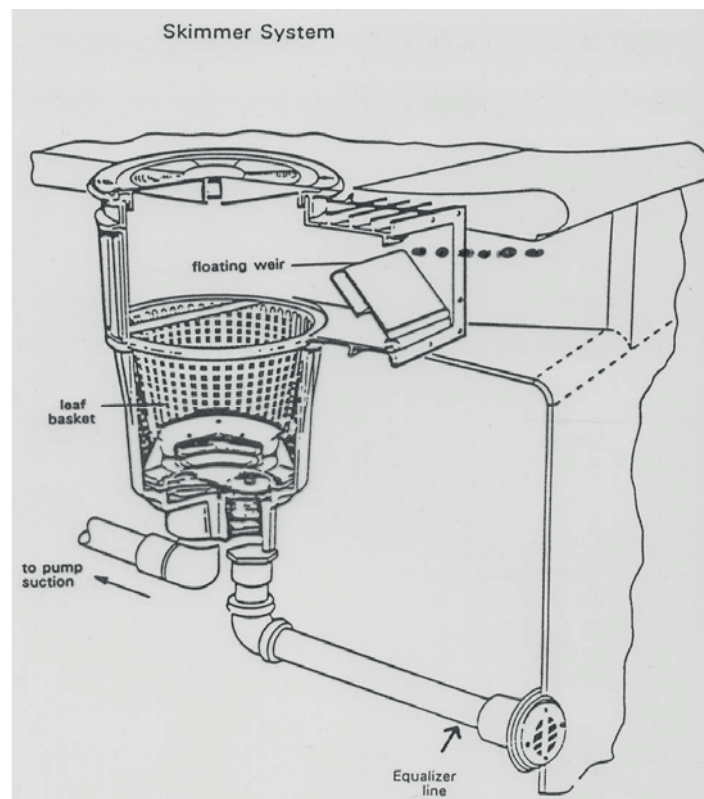

Picture: Skimmer Assembly

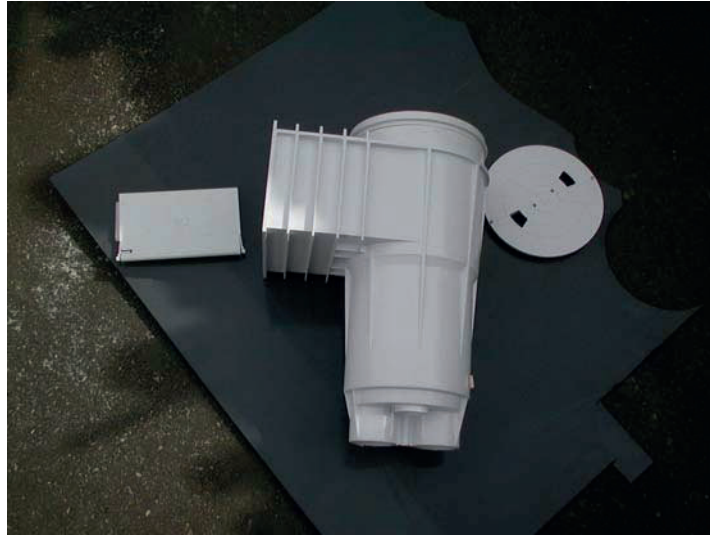

Picture: Floating Weir Insert



3. Overflow Gutters

Overflow gutters serve the same purpose as skimmers, but skim a much larger surface area. A **balancing or surge tank** needs to be used with the gutter system.

The surge tank will store water that is displaced by bathers entering the pool. As bathers leave the pool the water is sent back to the pool from the surge tank to maintain water level

at the lip of the gutter system for constant skimming action. A surge tank will also ensure the pump pulls water rather than air.

Picture: Overflow Gutters

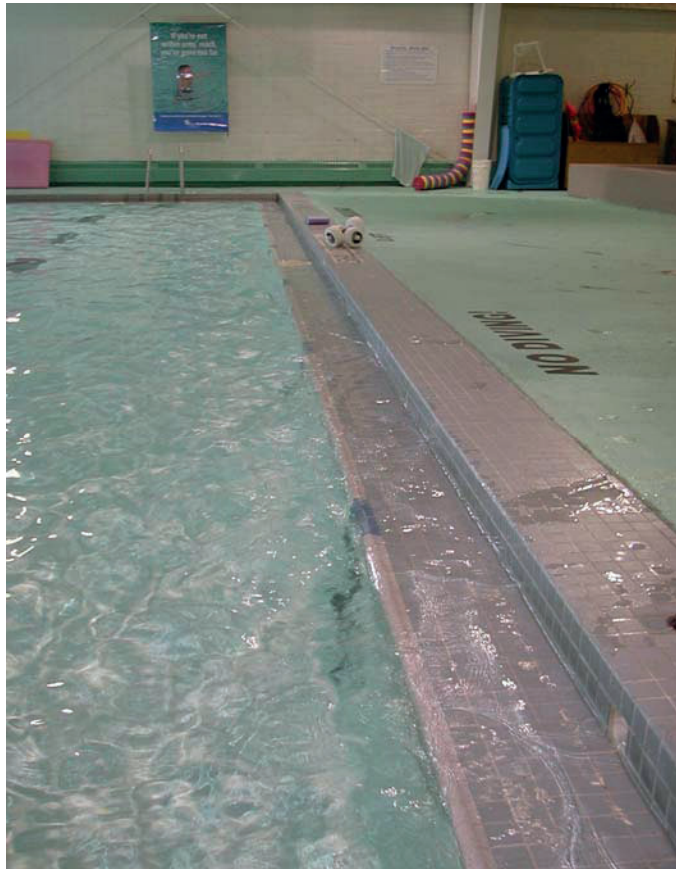

4. The Main Drain

The main drain is located at the lowest point of the pool floor. It is used as part of the recirculation system to remove heavier debris that does not float. It is also used to drain the pool when required.

The main drain is a good indicator of clarity. If the main drain can be seen from the deck, then an underwater swimmer or swimmer in distress would also be visible in the deep end.

Following are some safety concerns with the main drain:

- grates covering the main drain must be secure to the floor

- suction through the main drain must be at a velocity that swimmers will not be drawn down onto the grate
- holes in the grate must be sized properly so that fingers or toes do not become lodged between them
- the grate should be painted a contrasting colour (aids in visualizing water clarity; stands out as a warning to swimmers)

Note that the Building Code also has requirements that must be met at time of construction regarding size of the main drain and rate of water flow.

Entrapment Prevention

Pools with submerged suction outlets should be equipped with one of the following anti-entrapment devices:

- A minimum of two outlets per pump with pipe centres at least 920 mm (3 feet) apart with covers listed, approved and installed in accordance with American Society of Mechanical Engineers (ASME) and American National Standards Institute (ANSI);
- Anti-entrapment covers on all suction outlets other than the skimmer(s), listed, approved and installed in accordance with ASME A112.19.8M performance requirements and flow through drain grate which does not exceed 1.5 feet/second;
- A safety vacuum release system that relieves suction when a blockage is detected and that is installed to meet the performance standards of the ASTM International F2387 and/or ASME/ANSI A112.19.17s
- Drains which are at least 46 cm x 59 cm (18 x 23 inches) in size, or
- If approved by the Executive Officer, alternative anti-entrapment devices or solutions may be implemented which:
 - Comply with Guidelines for Entrapment Hazards: Making Pools and Spas Safer. United States Consumer Product Safety Commission March 2005, or
 - Are approved by a professional engineer

The responsible person must ensure that all anti-entrapment devices are properly installed and in good working order.

The responsible person must be able to demonstrate that no entrapment or entanglement risk exists in the operation of a pool.

5. Hair and Lint Strainer

The hair and lint strainer is located ahead of the recirculation pump (usually it is part of the pump unit). Its purpose is to remove objects, hair, or lint that may damage the pump.

This strainer must be checked daily and cleaned as often as necessary. It is recommended that a spare basket be used so that the pump is only shut off for a limited time while changing the hair and lint basket.

Picture: Hair and Lint Strainer



6. Recirculation Pump

Centrifugal pumps are used in swimming pools to either pull water from the pool and push it through the filter (closed filter tank) or to pull water through the filter and push it back to the pool (open filter tank).

The two characteristics against which pumps are measured are flow rate (measured in gallons or litres per minute) and water resistance or total dynamic head (measured as 'feet of head'). A pump must circulate enough water to meet the required number of turnovers and overcome any resistance in the system.

The friction of water in the pipes and filters, as well as the necessity to lift water causes resistance in the system. Pump manufacturers supply a pump curve with each pump that states the flow rate as compared to the feet of head.

Once the total resistance in the system is calculated, one will be able to read how many litres of water per minute a pump will pump at a determined resistance.

Pictures: Centrifugal Pump

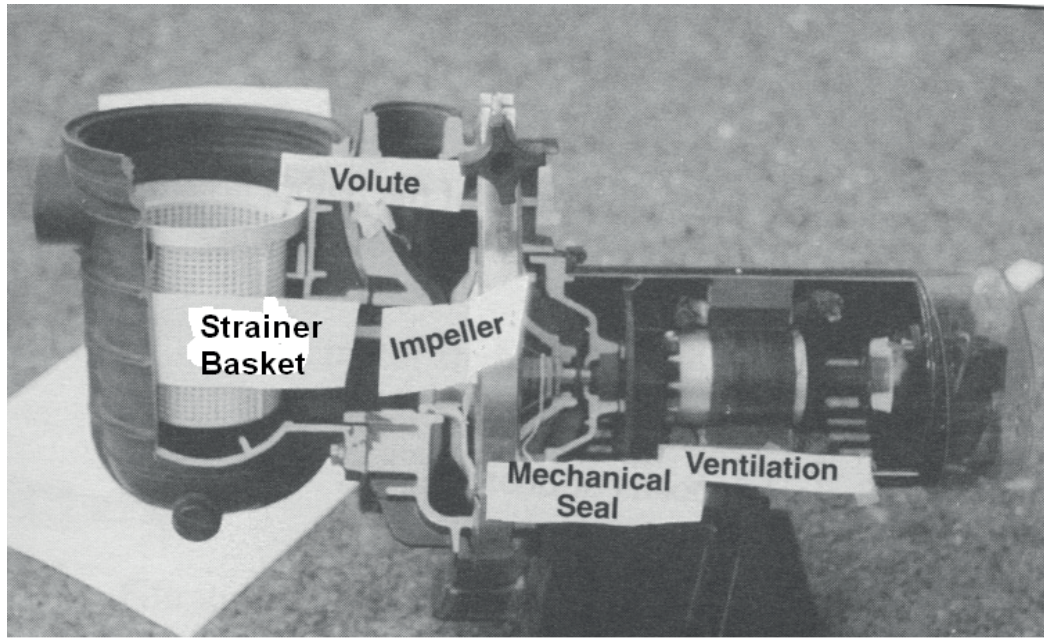

Pictures: Centrifugal Impellers



Diagram: Example of a Pump Curve

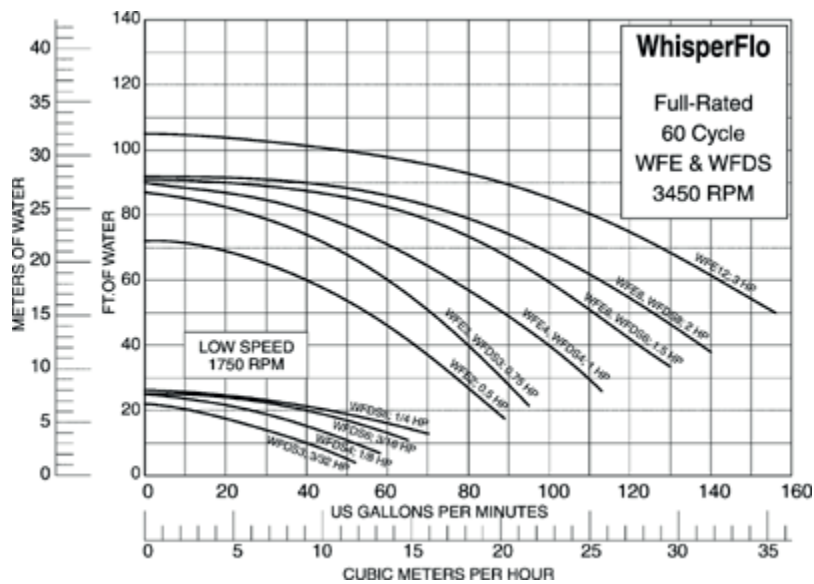

7. Filters

A swimming pool filter consists of a tank containing some small pore material such as sand through which water is forced. As the water passes through the filter, some of the particulate matter in the water will cling to the grains or fibres and others will be trapped in the spaces between them. As the spaces, or voids, between the materials become clogged with dirt, it becomes increasingly more difficult to force water through. Either the force used to move the water through must be increased, or the rate of flow will decrease.

Specific filter types will be discussed in the next section of the manual.

8. Flow Meter

The flow meter measures the actual flow rate of the water as it moves through the recirculation system and can be used to ensure the required number of turnovers is met.

The flow meter is located after the filters in order to measure the flow rate of the water returning to the pool. Flow meters improperly located ahead of the filter are influenced by the increasing pressure from the filter and are not an accurate indication of water flow.

Sand particles or other debris may restrict movement of the float located inside the meter. As such, flow meters must be cleaned on a regular basis.

Flow meters must be installed according to manufacturer recommendations to accurately reflect the water flow. Improper installation of a flow meter may affect the reading obtained. Elbows, pipe diameters and space constraints are some determinants regarding the location of installation. Typical installation requires a distance equivalent to 10 times the pipe diameter prior to the flow meter and 5 times the pipe diameter after the flow meter.

Picture: Flow Meter



9. Water Heater and Heat Exchangers

Water heaters and heat exchangers are used to maintain desired pool water temperatures.

The heater should be located after the filters to prevent debris and calcium build-up in the

heater. Heat exchangers should be located before any chemical addition to prevent corrosion.

The formation of scale deposits can reduce the heater's efficiency. Scale deposits restrict the ability of the metal to transmit heat. Water with high pH or hardness may cause this. If the pH is low, a problem with corrosion may develop in heat exchangers having copper lines.

Picture: Water Heater



Picture: Heat Exchanger



10. Chemical Feeders and Automation

Most well operated pools have automated mechanical chemical feeders to add chemicals directly into the return line in order to maintain pH and disinfection levels in the proper range. These chemicals are usually soda ash, sodium hydroxide, muriatic acid and various chlorine products.

Picture: Chemical Feeders

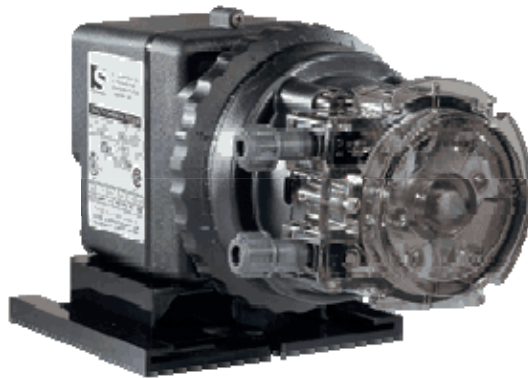

a. Automation

Chemical feed pumps must be controlled by an automated monitoring device. Automation includes the real time monitoring of the disinfection value and the pH of the pool water. Disinfection and pH monitoring probes continually check the water. The probes monitor water being returned to the equipment room (typically after filtration to reduce fouling of the probe) and record a value which is monitored by a control panel. The control panel then sends a signal to the chemical feed pump when chemical adjustment is required which automatically adjusts the chemical level.

b. Oxidation Reduction Potential (O.R.P.)

Automated systems typically measure disinfection values in millivolts indicating the strength of the Oxidation Reduction Potential (ORP) or Redox. Redox refers to the property of disinfectants and their ability to be strong oxidizers. ORP works with all standard disinfectants and is an accurate way to judge the actual disinfecting power of the chemical used for disinfection.

ORP cuts through the complicated tangle of variables (type of disinfectant, influence from pH, temperature, etc.) and gives a simple, reliable and accurate reading of disinfectant activity and water quality. It directly measures the electrical potential resulting from oxidizing agents in the water. In effect, ORP indicates the total disinfection level; therefore by relying on an ORP reading, you are not as concerned about how much chlorine is in the pool, but rather how effective the chlorine is.

ORP measuring instruments are like a highly sophisticated voltage meter. Data has shown that when 650 millivolts (mV) or more is measured, the water being tested has good bacteriological qualities. However, when the ORP falls below 650 mV, bacteriological contamination was evident. When a pool has an ORP value of 700 mV or more, a free chlorine residual of at least 0.5 ppm must be maintained. Chlorine residuals must be higher if the ORP value is below 700 mV.

In pools where cyanuric acid (CYA) is used (outdoor pools), inaccuracies in ORP readings can happen due to high levels of the CYA. It is therefore very important

not to exceed the maximum recommended concentration of CYA in the water. Data has shown that high pH values and high CYA levels can lead to low ORP levels, even though the parts per million of free chlorine is above the minimum recommended value.

c. Probes

An ORP probe is two electrodes contained in one casing. A reference electrode and a platinum electrode allow the transfer of electrons to be measured when the probe is immersed in water. The pool water acts as a conductor to complete the circuit.

d. Controllers

There are a number of manufacturers of ORP/pH controllers. All controllers use basically the same type of electrodes. The installation of the ORP/pH controller is shown below:

Examples of ORP/pH controllers and probes are shown below.



Sensors are mounted on the recirculation line with standard PVC fittings. The controller activates chemical feed pumps (or a solenoid valve to control water flow through an approved erosion feeder) when pH or ORP readings drop to a pre-set point. Feed is stopped when readings increase to a pre-set point.

Manufacturers of ORP/pH controllers recommend these units be calibrated based on the conditions at the individual facility. Calibration is also required after cleaning or

maintenance is performed on the probe. Follow manufacturer's instructions for calibration.

Cleaning of the probe is performed with a soft, non-abrasive cloth. Acid solutions and degreasing solutions are often used to prevent scratching of the metal sensing surface.

Automated systems do not replace the need to do manual tests. If you have an automated system, you must still complete manual tests of chlorine and pH at least once per day.

e. Amperometric Titration/Probes

Another type of automated system that can be used to monitor disinfection levels is amperometric titration. This is an oxidation-reduction titration procedure which determines the concentration of chlorine. A small electrical voltage is applied across two electrodes and measures the change in current from chemical reactions after a titrating solution has been added. The titrating solution measure changes in millivolt readings from the start of the titration to the end of the titration and gives a direct reading of free available chlorine. This test is not subject to interference from colour or turbidity.

Although extremely accurate, amperometric titration goes beyond the requirements of smaller pool facilities.

Picture: Amperometric Titration



C. Summary - Physical Treatment: Pool Recirculation

Operators of swimming pools must be familiar with all the equipment they are required to operate. A flow chart diagram is an excellent guide and should be posted in the equipment room.

All equipment should be clearly identified and colour coded. A good working knowledge of your pool equipment is essential. Regular checks and maintenance of all recirculation system components must be done to keep them in good repair and prevent damage to your pool or harm to the bathers.

D. Review Questions: Physical Treatment: Pool Recirculation

1. Name three safety concerns with the main drain.

2. What two types of systems could be used to remove hair, lint and other debris from the surface of the pool water?

3. Define a turnover.

4. How many turnovers per day are required for a new swimming pool operation?

PART 2: FILTRATION

A. Concept of Filtration

Water for swimming must be **physically** clean. Water in a swimming pool that appears dirty or cloudy is said to be **turbid**. Water that is turbid may not be physically safe as bathers may not be clearly seen if they are in distress. Turbid water can also interfere with the disinfection process causing harmful bacteria and viruses to remain in the water. Pool water must pass through a filter system to remove dirt, oils and other particles that make the water unclean.

1. Turbidity

Physically clean water is free from **particulate** matter which includes dirt, oils, and dissolved minerals. Clean water is obtained by pumping the water through a filter to remove the solids prior to returning it to the pool.

Turbid water will appear hazy or cloudy. Slightly turbid water does not have the desired sparkling look. Excessively turbid water can be so cloudy that the pool bottom cannot be seen. Excessive turbidity is unsafe. If you cannot see to the bottom of the pool, you cannot see a swimmer in trouble.

If the main drain cover cannot be seen in detail, use of the pool must be prohibited. The pool should have the best possible clarity, not only for safety, but also for proper disinfection of the pool water and improved length of filter runs.

2. Turbidity Standard

Turbidity measures how clear the water is. The pool should set a standard of 0.5 turbidity units or less for swimming pools. Testing equipment is available to measure turbidity. Where clarity problems persist, turbidity testing equipment may be required for the facility.

3. Backwashing

When it becomes too difficult to move water through the filters at an adequate flow rate, the filter must be **backwashed** (cleaned) with the dirty water sent to waste. Once backwashing is completed, the pressure reading(s) should be recorded and the filter put into operation again.

After backwashing, a new **filter run** begins. A filter run is the length of time between backwashes and may vary from a few hours to several days or weeks in some cases. The factors that will dictate how often backwashing will be required are:

- i. The quality of the water supply.
- ii. The type, design and size of the filters.
- iii. Bather load.
- iv. The location of the pool (indoor, outdoor, near a dusty street).
- v. Algae growth.

Filter pressure is the factor that determines when a backwash is required. The filter pressure desired to initiate backwashing is dependant on the type of filter being used. All filters must be backwashed and cleaned according to manufacturer instructions.

B. Types of Filters

1. Sand Filters

The most common type of sand filter in use today is the **high rate pressure sand filter**. The **low rate pressure filter** (also known as **rapid sand filters**) is not in common use now, but is discussed in the text for your information.

a. High Rate Pressure Sand Filters

i. How They Work

The high rate filter consists of a closed tank containing an upper distribution system or baffle, sand and a collection manifold. On the top of the filter tank is a multi-port valve that allows the operator to control the direction of the water flow from one valve. This is where the water coming from the pool enters the filter tank. Large filters may have water distribution line valves to manually control water direction in the absence of a multiport valve.

The water passes through a **baffle** that evenly distributes the water over the filter bed of sand. The water travels through the filter bed leaving debris on the filter surface.

As more water passes through the filter, the added debris forms a mat on the surface that increases the pressure. The pressure pushes this dirt into the filter, allowing the surface to continue the filtering process.

Filtered water is collected at the bottom of the tank through the underdrains in the **collection manifold**. This water is sent back to the pool.

As the dirt is pushed deeper and deeper into the filter bed the pressure continues to increase until such time that the flow of water is restricted through the filter and the flow rate is affected.

Diagram: High Rate Pressure Sand Filter (Water Flow While Filtering)

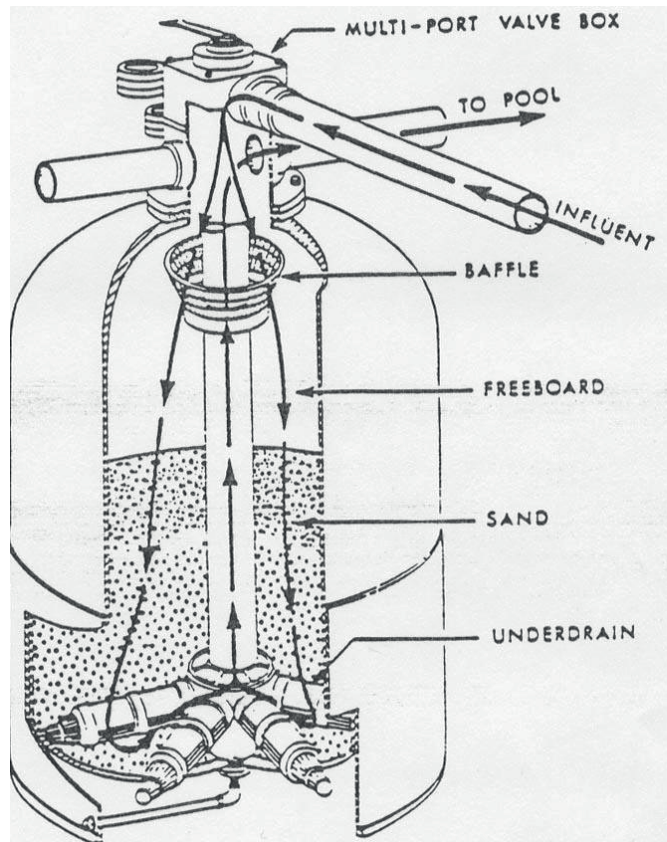

ii. Flow Rate

Optimum operating procedures indicate that filtration rates for swimming pools should not be more than 57 litres/minute/square foot (15 US gallons/minute/square foot) and 47 litres/minute/square foot (12.5 US gallons/minute/square foot) for whirlpools, or follow manufacturers specifications.

iii. Backwashing

For filters with pressure gauges on both the influent (incoming) and effluent (outgoing) sides, a backwash should be done when the pressure differential between the two gauges is 68-103 kPa (10-15 psi).

Where only one pressure gauge is present, it must be located before the filter. After backwashing, the pressure gauge will measure the backwashed or clean filter pressure, which the pool operator should note. The pressure reading on the gauge will increase over time. Follow the manufactures instructions as to the pressure reading that indicates another backwash is required. This is generally a pressure rise of about 8 psi.

During a backwash, water from the pool enters the filter tank and is directed to the manifold (underdrains) at the bottom of the tank. Water is then circulated from the underdrains up through the filter bed to expand the sand and loosen the dirt particles, which are sent to waste.

General procedures for backwashing high rate filters are:

1. Shut off boilers (heaters) approximately 30 minutes prior to starting backwash. This prevents excess heat build up and potential explosion.
2. Shut off pump to prevent excess pressure on the multiport valve.
3. Arrange valves/multiport in backwash position.
4. Turn on pump and leave on until water runs clear.
5. Shut off pump.
6. Clean hair and lint strainer at this time as the system is already turned off.
7. Arrange valves to **downwash or rinse** position.
8. Start pump and run for 1 minute.
9. Shut off pump.
10. Arrange valves to normal filter position and start pump.

The time required to backwash a high rate pressure sand filter can vary, but generally takes 2 to 4 minutes. A **sight glass** should be present to view the water going to waste. The sight glass allows the operator to determine when the backwash water is clear, indicating backwashing is complete.

Diagram: High Rate Pressure Sand Filter (Backwash Water Flow)

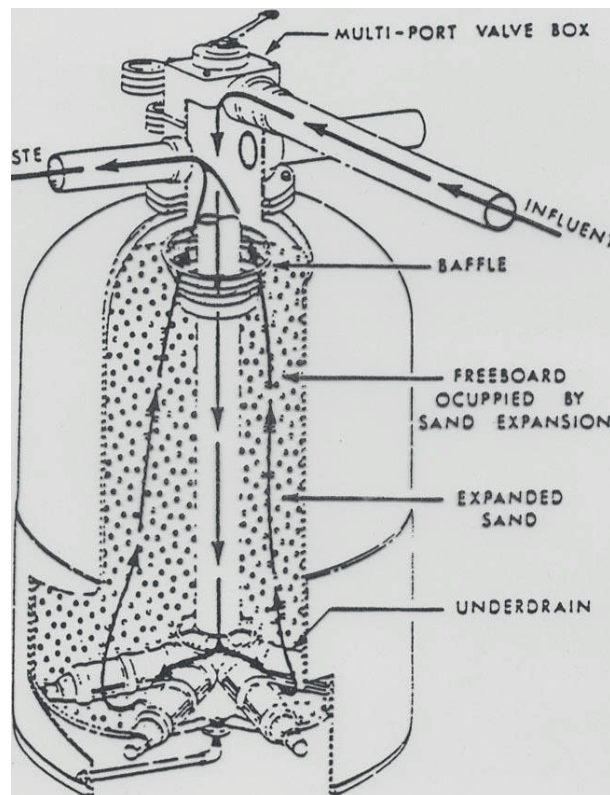

Downwashing is setting the filter to the normal flow pattern, but discharging to waste for the first 30-60 seconds. Downwashing is designed to prevent a small surge of dirt from entering the pool as the sand in the filter settles back after backwashing.

iv. Operational Problems

Problems occur if the filter is not operated properly. Insufficient backwashing or insufficient flow rates during the backwash cycle may not remove all of the debris and dirt in the filter bed. This will eventually lead to accumulation of debris in the filter referred to as **mudballs**.

Mudballs will build up on the filter surface and reduce the area available for filtering. As these mudballs grow in size and weight they are forced deeper into the filter. With the existence of mudballs, the water will tend to channel along side and reduce filtering efficiency. When water flows around a restriction and makes a permanent path in the filter media it is referred to as **channelling**.

Channelling may occur from mudballs being present in the filter. Channelling may also occur as a result of a broken baffle that no longer distributes the water evenly over the filter media causing a channel to occur in the sand.

Another problem due to insufficient backwashing is **calcification**. This is a common problem in hard water areas due to the high number of calcium compounds. Calcium carbonate crystals can build up into a solid mass encrusted into the filter bed. At the point when the filter bed becomes impervious and channelling will result. Both of these problems can be corrected by chemical treatment or filter sand replacement.

Other problems may arise from **backwashing too frequently**. As the sand filter starts to build up some pressure, more effective filtering is achieved. A small amount of sand can be lost during backwashing which after repeated loss may result in poor filtration.

If the pump pressure is not properly matched to the filter problems may arise. **Insufficient pressure** may cause incomplete

backwashing. The sand bed will not be properly expanded (fluidized) and mudballs or calcification may occur. **Excess pressure** during backwashing may result in over expansion of the sand that is then lost to waste. Backwash rates must match filtration rates.

An annual inspection of the filter and filter media should be conducted to check for any of the above noted problems.

Sand needs to be replaced after a period of time (dependant upon your facility's operation). Typical replacement occurs on an annual basis.

Pictures: High Rate Pressure Sand Filters





b. Low Rate Pressure Sand Filters

i. How They Work

The number of low rate pressure sand filters in use in swimming pools is declining as most pools are using the high rate pressure sand filter. Low rate pressure sand filter systems are composed of one or more cylindrical steel tanks generally placed in a row. The size and the number are determined by the pool requirements. A typical low rate pressure sand filter system at a public pool would consist of 3 or 4 tanks about 1.8 meters (6 feet) in diameter.

The pipes are arranged so that water flows in near the top of the tank and out the bottom. Adjusting a series of valves can reverse the direction of flow. Each tank has a collection manifold in the bottom and contains about 4 layers of gravel or crushed anthracite topped by a layer of sand or finely ground anthracite. The gravel layers are carefully screened for size so that stones of the finer gravel will not fit between the stones of the next larger size. Therefore, the finer layers will stay on top.

The gravel performs no function in the filtering process, but supports the sand and distributes the water flow evenly throughout the tank.

Pressure gauges mounted on the influent and effluent lines of each filter tank must be mounted at the same vertical height. They will show very little difference between incoming and outgoing pressure when the filter run is started with clean filters.

These filters will remove most solid matter from the water, but in many cases clarity can be increased noticeably by adding a **flocculent** such as alum to the filter.

ii. Flow Rate

The critical factor in the choice of filter size is the number of square meters of surface area on the top of the sand.

The total surface area of the filter sand should be such that the entire capacity of the pool can be pumped through the filter in 4 hours at a rate no greater than 120 litres per minute per square meter (3 gallons per minute per square foot) of filter area.

iii. Backwashing

As the filter run continues, dirt slowly collects on the filter material and begins to block the flow of water to the extent that the pressure gauge reading on the influent line begins to rise above the pressure gauge reading on the effluent line. When the difference in pressure between influent and effluent lines reaches 41 to 55 kPa (6 to 8 psi), it is time to backwash.

The backwash flow rate must be 4 times the filter flow rate to achieve effective backwashing. A backwash flow rate of 580-780 litres per minute per square meter (12-15 gallons per square foot of filter area) will expand the sand layer and flush out all dirt and flocculent in 8 to 10 minutes.

iv. Operational Problems

The cost of backwashing more often than necessary or for longer periods than is necessary can be considerable and the addition of new make up water may have a detrimental effect on the pool water chemical balance.

To backwash the filters, all the valves must be adjusted in such a manner that the entire incoming supply from the pump will pass upward through one tank at a time.

An economically efficient operation requires that the backwash procedure be limited to the minimum amount of time necessary to get the filters clean. Full flow operation to waste for 8 to 10 minutes for each tank requires the use of a considerable quantity of heated, treated pool water. To prevent loss of water from the pool, water from the municipal distribution system should be used for backwashing if possible.

Serious consequences will result from failure to backwash when needed, or for too short a period or with less than the required rate of flow.

When the filters are inadequately backwashed, dirt may accumulate over a period of time and form lumps or balls of hair, grease and other organic matter that will destroy the ability of the sand to filter properly.

Diagram: Low Rate Pressure Sand Filter

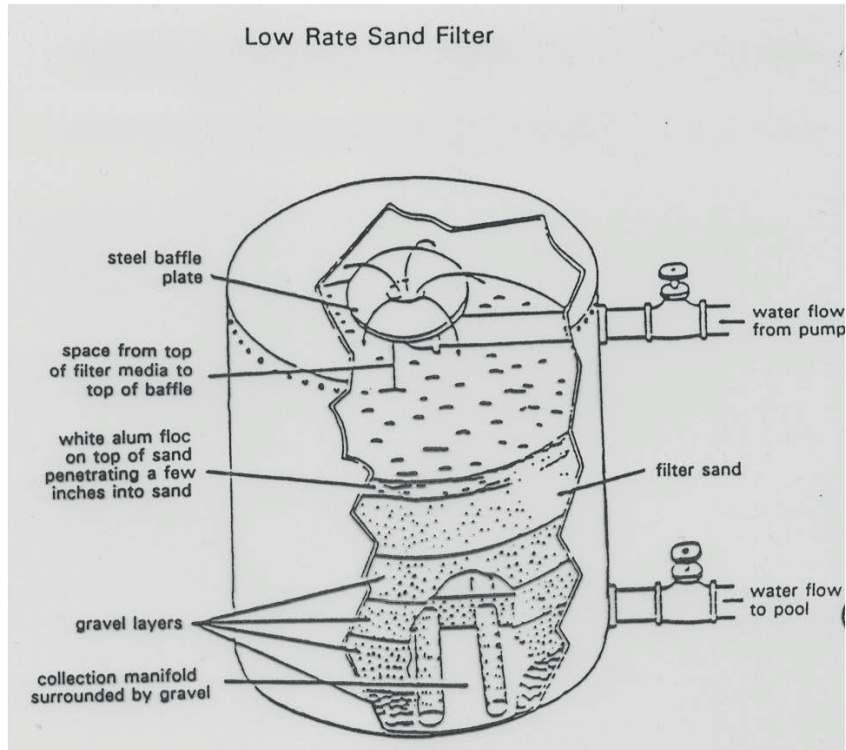

2. Non Permanent Media Filters

Non permanent media filters use substances with extremely small pore sizes to trap the particulate matter in the pool water. This filter media is flushed to waste during backwash procedures, thus the name 'non permanent'. Non permanent filter media are either **diatomaceous earth (D.E.)** which is a natural substance, or a man made alternative to D.E. such as **Perlite**.

a. How They Work

Diatomaceous earth chemical composition is similar to that of sand and it does not react with any chemicals used in swimming pools.

The name diatomaceous earth is derived from the fact that it is composed of the fossil remains of tiny aquatic plants called **diatoms**.

Water passes readily through and around these grains, but the openings are so small that a layer of diatomite only 3 millimetres (1/8 of an inch) thick will

provide a filter bed equivalent to 0.6 meters (2 feet) of sand. It will retain particulate matter so small that even some micro-organisms can be filtered.

Perlite is silica which has been ground to a specific size then expanded under heat to form shapes and crevices that aid in the filtration process. The issue of being a hazardous respirable material is not present such as with DE.

The two basic types of non permanent media filters are:

- i. Pressure Filters - use a closed tank.
- ii. Vacuum Filters - use an open tank.

Diagram: Pressure Non Permanent Media Filter

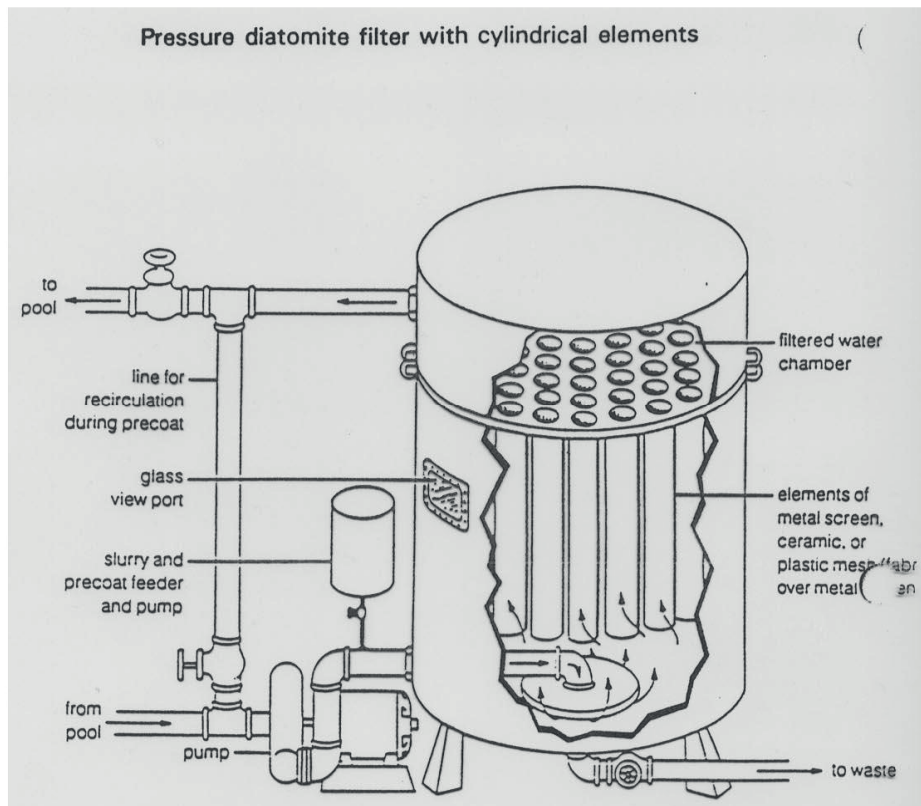

To begin operation of a non permanent media filter, the filter must be isolated from the pool by closing valves leading from the pool to the filter, and from the filter to the pool. The recycling valve must be opened, allowing water from the filter to be directed through the pump and back into the filter again.

When the filter tank has filled with clean water, the pump is started and recycling begins. Non permanent media is introduced to the filter tank through a feeder or is added directly to the filter by hand. As the water passes through the filter, the larger particles of diatomite or perlite are caught on the surface of the elements and the smaller particles pass through.

These larger particles block the element screen so that they, in turn, will catch the smaller particles as they are recycled again and again. This process is called **pre-coating** and results in a smooth even layer of non permanent media (called a **filter cake**) covering the surface of the filter elements.

The **pre-coat** is complete when all of the element surfaces have been coated with perlite or diatomite. The valves leading from the pool to the filter and from the filter to the pool are then opened and the recycling valve is closed in that sequence. This arrangement of valves allows water from the pool to be either pushed (as is the pressure filters) or pulled (as in the case of the vacuum filter) through the layer of filter media and fed back into the pool.

Opening valves resulting in a loss of pressure on the filter cake may cause the filter cake to fall off. The precoat must then be started over.

Suspended particles of dirt from the pool will begin to clog the pores of the filter cake causing the flow rate to decrease and the pressure/vacuum to increase.

The filter run can be extended by the addition of filter media during the filter run. It will mix with the dirt and keep the filter layer porous as it builds in thickness.

The continuous addition of non permanent media during the filter run is called **body feeding** or **slurry feeding**. The rate of slurry feeding is dependent upon the rate at which dirt from the pool is clogging the filters. A greater slurry feed rate is necessary during periods of heavy bather load.

Chemical aids such as flocculants are not used with non permanent media filters, as they would only clog the filter cake and shorten the filter run.

b. Flow Rate

In non permanent media filters, flow rates of 120 litres per square meter (2.5 gallons per square foot) of filter area are recommended for greatest efficiency.

c. Cleaning Non Permanent Media Filters

When the elements become sufficiently clogged so as to reduce the flow rate significantly, the material must be replaced. The point at which pressure filters should be cleaned depends upon the design of the filter. Manufacturer recommendations should be followed.

Cleaning the non permanent media filters is not always accomplished by a reversed flow. Some filters are cleaned by air expanding inside the elements from a special compressor. Some elements are cleaned by flexing the element within the tank, or by rotating the entire element with a hand crank causing centrifugal force to clean the element. Still others are cleaned by spray nozzles directed on the elements. Most vacuum filter elements are cleaned by spraying them with water from an ordinary hose.

When the filter tank is clean, it is refilled with clean water and the pre-coat process is repeated. New filter media is introduced for each filter run.

d. Operational Problems

i. Clogged Filter Elements

It is important to keep the filter elements clean. If dirty water is allowed to circulate through the filter without a coating of diatomite or perlite on the elements, they may become clogged with dirt. Grease on filter elements may also result in the DE or perlite not coating that section of the element. Occasionally, filter elements may become clogged with scale, rust or grease, even under the best of operating conditions. In such cases, it will be necessary to clean or replace the elements.

In most cases, if the clogging substance is greasy in nature, it can be removed by recycling water to which a generous quantity of a

low sudsing detergent has been added. Recycling for 2-3 hours, followed by a very thorough rinsing should be sufficient.

If rust or scale clogs the filter elements, they can be cleaned by recycling water in which several kilograms of oxalic acid have been dissolved. **Oxalic acid should not be used for bag-type filters.** The filters should be thoroughly rinsed before returning them to service.

On some occasions, the filter elements may become so badly clogged that the only solution is to remove them and scrub them by hand. Elements in vacuum filters may need to be removed and replaced on occasion.

ii. Power Loss

Whenever the pump is stopped, even momentarily, the filter cake loosens, shifts, and may drop from the elements. Restarting the filter without first cleaning and pre-coating causes dirt to come in direct contact with the filter elements, which may damage the elements. It may also result in dirt and diatomite being washed into the pool. Always clean and pre-coat before re-starting a filter cycle. Perlite has been reported as forming a more stable filter cake and is less affected by power losses.

Diagram: Vacuum Non Permanent Media Filter

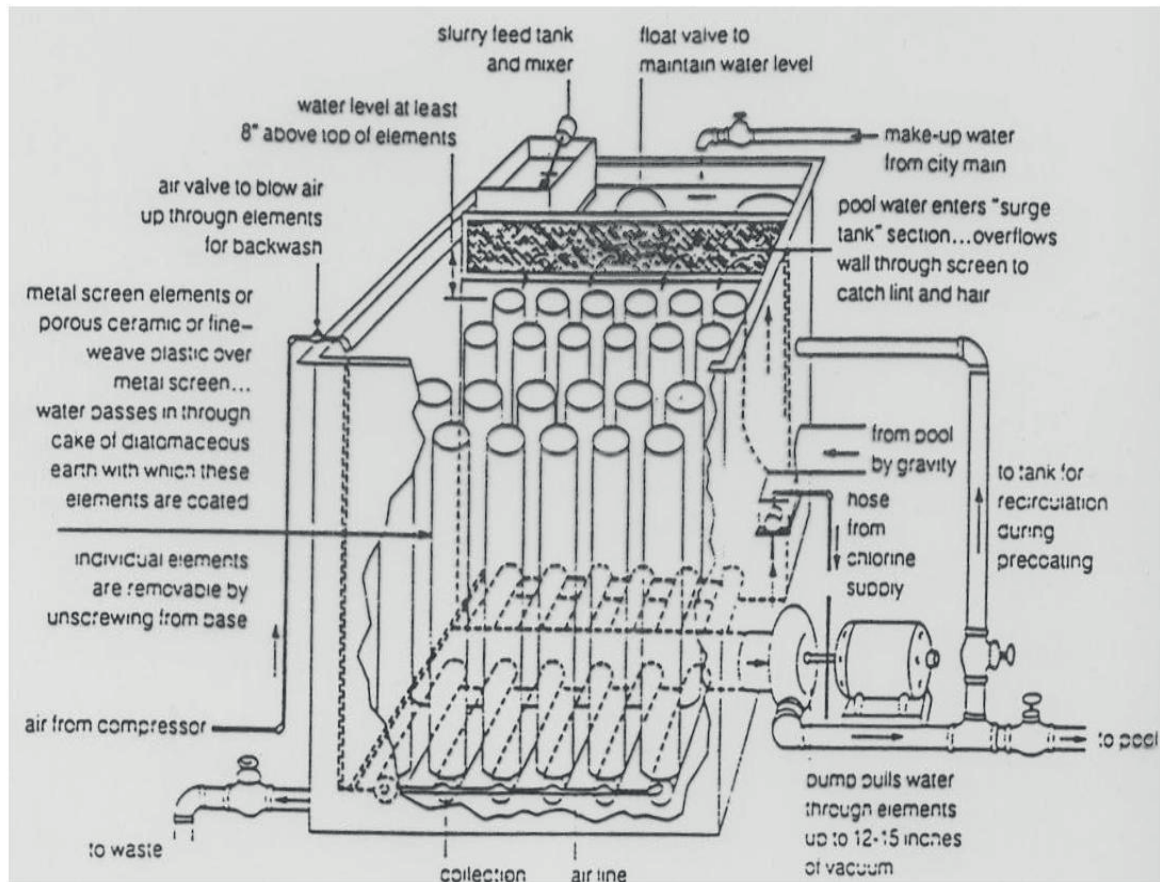

3. Cartridge Filters

a. How They Work

Cartridge filters are sometimes used in small volume swimming pools. The filters are generally made of a pleated material consisting of polyester or Dacron. Although the material has a much lower filter capacity per square foot, the pleating greatly increases the filter area.

The filter resembles an air cleaner found in a vehicle. Water will pass through the filter but dirt and other particles will not. Cartridge filters generally become more efficient as they become slightly soiled. The larger debris becomes trapped in the material, which aids in the filtering of smaller particles.

Cartridge filters traditionally have relied on surface area for filtration capacity. Some cartridge filters on the market rely on depth of the filter as well.

Although these filters are available, most are not practical for large pools.

Pool using cartridge filters must have a second set of filters available to allow for adequate cleaning.

b. Cleaning Cartridge Filters

Most cartridge filters are cleaned when the filter pressure reaches an 8 to 10 psi difference between the filter inlet and outlet. Always check the manufacturer recommendations. A second set of cartridge filters are required on site to allow for continuous circulation when the other set is being cleaned.

When the filter becomes dirty it can be cleaned with a high-pressure air hose or with an ordinary water hose. Cleaning aids such as degreasing agents or acid washes are sometimes used to enhance the cleaning process. Each manufacturer may have different recommendations.

c. Operational Problems

When the filter can no longer be adequately cleaned, it must be replaced. The large commercial drum style filters can be very expensive.

Some less expensive filters are designed to be disposable and are replaced when they become dirty. Disposable filters must not be reused.

Cartridge filter systems are generally not viable for large volume pools.

Picture: Cartridge Filters

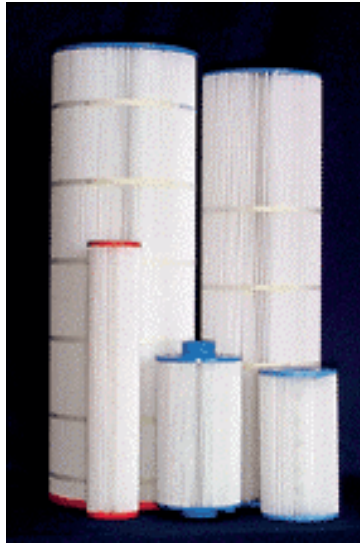

C. Summary - Physical Treatment: Filtration

Swimming pool water is filtered to remove particulate matter to keep the water physically clean. The three types of filters used in swimming pool operation are sand filters, non permanent media filters and cartridge filters.

Flow rates differ for each type of filter used. A reduced flow rate indicates that the filter(s) must be backwashed or cleaned.

High rate sand filters are more commonly used than low rate sand filters because the high rate sand filters are more efficient.

Non permanent media filters use substances with extremely small pore sizes to trap the particulate matter. These substances are either diatomaceous earth (D.E.) or a less hazardous man made alternative called perlite.

Cartridge filters use a pleated synthetic fibre to filter water. They are sometimes used in small volume pools, but are not viable for large pools.

D. Review Questions: Physical Treatment: Filtration

1. Name three types of filters that can be used in swimming pools.

2. Give two examples of problems that may occur with sand filters due to insufficient backwashing?

3. Define the term backwash.

4. Name four factors that affect the length of a filter run.

CHEMICAL BALANCE

PART 1: PH CONTROL

Balanced pool water has certain chemical components that are within appropriate ranges for bather comfort, disinfection efficiency and protection of pool equipment and basin. The source of pool and make-up water, as well as the chemicals and contaminants introduced into the water, determine the chemical composition of water in the pool. In order to achieve balanced water, pH, total alkalinity, calcium hardness, total dissolved solids and temperature must be maintained within proper ranges. These chemical parameters will change over time. They must be monitored regularly and adjusted as required to keep the water balanced. To accomplish this, pool water must undergo chemical treatment.

A. Theory of Acid Base Chemistry

Water is a simple compound of hydrogen (H) and oxygen (O). When water (H₂O) splits, it forms hydrogen ions (H⁺) and hydroxyl ions (OH⁻). This splitting process is called **ionization**.



Pure water ionizes leaving an equal number of H⁺ and OH⁻ ions in a solution. These charges cancel each other out. The resulting solution has no net charge, positive or negative. Water is neither acidic nor basic and is called neutral.

All pool chemicals ionize when added to water. If a chemical breaks up into its composite ions leaving free H⁺ ions, the chemical is said to be an acid. If this chemical is added to pool water, the water will become more acidic. Conversely, if the chemical breaks up leaving free OH⁻ ions, it is said to be a base. If this chemical is added to pool water, the water will become more basic.

B. pH

pH is a number given to a substance which is related to its acidity. It is measured on a scale ranging from 0 to 14. pH is a measure of how much hydrogen (H⁺) or hydroxide (OH⁻) ions are present in the solution. Pure water has a pH of 7, the midpoint on the pH scale. Because they have more H⁺ ions than OH⁻ ions, acids have a pH lower than 7. Solutions with pH approaching zero on the pH scale are extremely acidic. Bases, which have more OH⁻ ions, have a pH greater than 7.

Diagram: pH Scale showing the pH of Various Substances

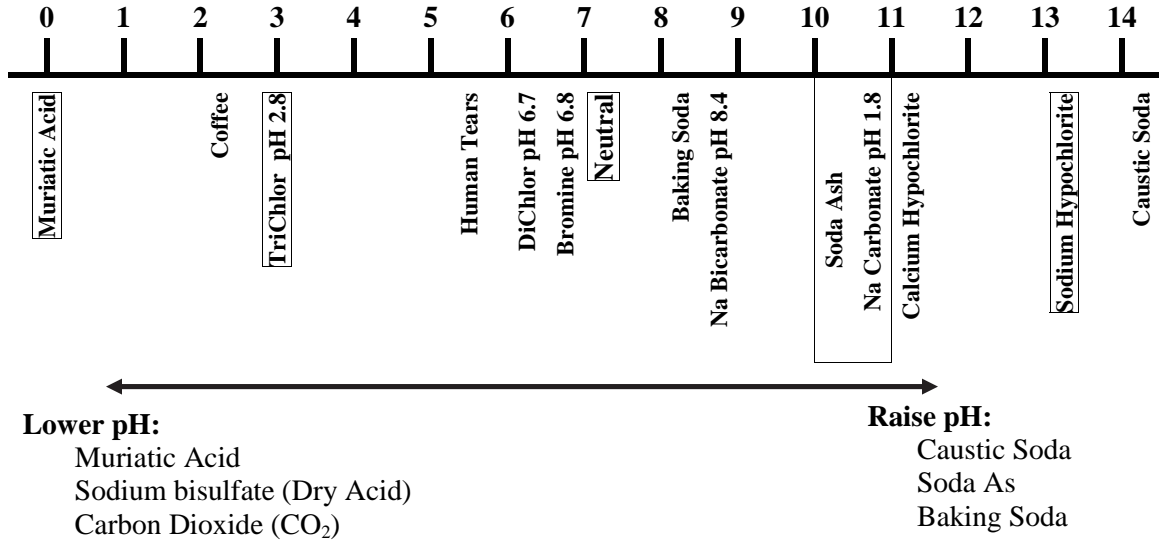

1. pH Determinants

Many factors affect the pH of pool water. Every substance that enters the pool may cause the water to become either more acidic or more basic.

a. Source water

The most abundant chemical in your pool is the water itself. The pH of the source water can vary due to where it comes from and the time of year. It is the start of all your chemical parameters. As an example, the City of Calgary water has a pH that ranges from 7.3-8.0.

b. Swimmers (and their wastes)

Body oils, sweat, urine, perfumes and lotions, etc... all have their own pH and will affect the pool water depending on their values and amounts.

c. Disinfectants:

The pH will increase or decrease depending upon the type of chlorine product used as a disinfectant:

- Gas chlorine: pH < 1
- Lithium hypochlorite (powder): pH 10.7
- Calcium hypochlorite (powder): pH 11.8
- Sodium hypochlorite (liquid): pH 13.0

d. Water Balance Chemicals:

pH adjusting chemicals (acids and bases) commonly have the greatest effect on pH. However, all the other chemicals you add to the pool (de-scaler, floccs, shocks, algaecides etc.) will also have an influence on your pH.

e. Others:

Factors such as organic contamination from the land or air, aeration, evaporation, and temperature will also potentially affect the pH of your pool.

2. Importance of pH Control

Control of pH is important because it affects almost all aspects of pool operations. Changes in pH will alter the factors as discussed below.

a. Disinfectant effectiveness

When any type of chlorine is added to the water, it disassociates into the following:

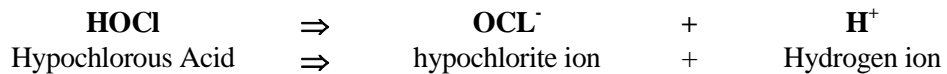

The hypochlorous acid ion is a much more effective disinfectant than the hypochlorite ion. The hypochlorite ion (OCl⁻) is about 1/100th the strength of hypochlorous acid (HOCl). **The higher the pH, the less hypochlorous acid forms in the pool water, decreasing the effectiveness of the chlorine as a disinfectant.** These two forms of chlorine are both detected when you test for free chlorine. Your test kit can not distinguish between the hypochlorite ion and hypochlorous acid.

b. Bather comfort

Skin and eye irritation occurs with high or low pH.

c. Equipment maintenance

Corrosion of pipes and other pool equipment can occur as a result of low pH. Scaling of pool surfaces can occur if the pH is too high.

d. Flocculent use

A low pH prevents good flocculent formation.

e. Algae growth

High pH reduces the effectiveness of chlorine which may then allow algae to grow.

Diagram: Effects of pH

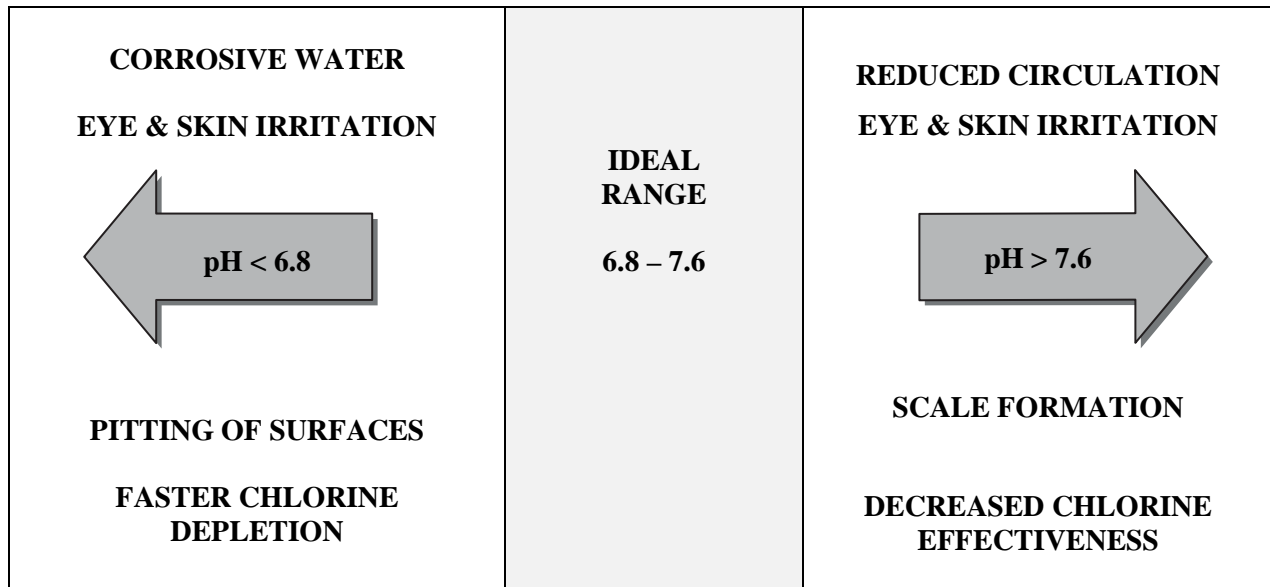

3. Requirement for pH

The pH of water in the pool must be maintained at not less than 6.8 and not more than 7.6.

4. Control of pH

The pH of pool water can be raised or lowered using various chemical products. Chemical reactions take time, therefore, the best time to manually add chemicals is in the evening when the pool has closed down and no patrons are present. Adjusting chemical balance in the evening will also give time for the pool to stabilize prior to opening.

a. Lowering pH by Spreading Acid

To lower pH, a procedure called **spreading the acid** is required. To spread the acid is to add acid over the entire surface area of the water, or at least around the entire perimeter of the pool. This may be accomplished by batch method or mechanically by feeding acid through a chemical feeder intermittently.

The pH of the water can be lowered by the addition of **sodium bisulphate or muriatic acid**. The amount of acid (H^+) required to bring a high pH down to the correct level depends upon the pH drop needed and the volume of water.

b. Lowering pH with CO₂

Carbon dioxide (CO₂) can also be used to lower the pH of water. When CO₂ bubbles into water it creates carbonic acid which then dissociates to acid H⁺ and bicarbonate (HCO₃⁻) thus lowering the pH.

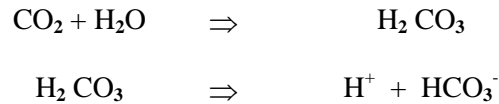

This reaction works in a high pH environment.

Disadvantages:

- Difficulty regulating carbon dioxide and properly diffusing in water
- Carbon dioxide tanks require regular monitoring to ensure they are not empty
- Increases alkalinity

c. Increasing pH

The pH of pool water may be increased by the addition of sodium carbonate (soda ash) or sodium hydroxide (caustic soda, NaOH). Soda ash is dissolved in water and the solution is added through a mechanical feeder on a continuous basis. Liquid caustic soda is added to the pool by a mechanical feeder.

One time adjustments can be made by manually adding chemicals to the pool when no bathers are present.

5. Effect of Temperature on pH

Temperature can be thought of as a source of energy that contributes to chemical reactions. Temperature can shift the pH of water the same as a chemical would.

For example, distilled water at 25°C has a pH of 7 whereas at 40°C the pH shifts to 6.7.

C. Summary - Chemical Balance: pH Control

pH is a number given to a substance which is related to its acidity or H⁺ concentration. It is measured on a scale ranging from 0 - 14. Substances with a pH below 7 are called acids. Substances with a pH above 7 are called bases.

The control of pH in pool water is very important because it affects disinfection effectiveness, bather comfort and pool water chemistry.

The required range for pH in pool water is 6.8 - 7.6. Chemicals may be used to lower or raise the pH as the situation requires. Acids lower pH and bases such as soda ash raise pH.

D. Review Questions: Chemical Balance: pH Control

1. List three reasons why a pH level below 6.8 is not desirable.

2. List three reasons why a pH level above 7.6 is not desirable.

3. If your pool has a pH level above 7.6, what chemical would you use to lower it?

4. Why is pH a concern for pool equipment maintenance?

PART 2: TOTAL ALKALINITY AND CALCIUM HARDNESS

A. Total Alkalinity

A substance that reacts with or neutralizes hydrogen ions (H^+) is called an **alkali**. Pool water contains alkaline substances such as **bicarbonate, carbonate and hydroxide** ions. Total alkalinity is a measure of these substances in the water and is measured in mg/L (ppm). Bicarbonate alkalinity is the most important form of alkalinity in pool water.

1. The Relationship Between pH and Alkalinity

As indicated in the previous section, pH is a very important factor in maintaining a chemically balanced pool. pH and alkalinity are very closely related. The pH of a pool can change abruptly or gradually depending not only upon the chemicals added, but also upon the alkalinity of the water. The alkalinity of the water holds the strings that regulate the pH levels.

Alkalinity has the ability to buffer pH. Alkalinity is the measure of the water's ability to resist changes in pH. The form in which alkalinity will exist in water is entirely dependent upon the pH. In fact, if you are maintaining your pH in the acceptable range of 6.8-7.6, the only form of alkalinity you will have in your pool is bicarbonate.

2. The Ideal Range for Total Alkalinity

Alkalinity must be maintained at 80-120 ppm and measured weekly.

3. Problems Total Alkalinity Can Cause in Pools

a. pH Drift

High total alkalinity can cause the pH of the pool water to gradually rise. This is known as pH drift.

When alkalinity is too high the water becomes over buffered. This will result in water that is resistant to pH adjustment.

In many areas of Canada, excess alkalinity is a common problem, particularly if the source of supply is a deep well.

High alkalinity can also cause cloudy water and scale formation on pool equipment.

b. pH Bounce

When the total alkalinity is too **low** in the pool, the buffering capacity is reduced and pH may fluctuate wildly. This is known as pH bounce. When alkalinity is low, pH bounce may occur even with minor chemical changes or if only a few bathers enter the pool. When no other parameters of the pool have been adjusted by the operator and the pH is changing, it may be due to a low alkalinity reading. The result is a pH that is difficult to monitor and/or control.

4. Effect of Cyanuric Acid on Total Alkalinity

In outdoor swimming pools, cyanuric acid (CYA) is used to stabilize the chlorine in the pool water. CYA in the water will affect the total alkalinity reading. When testing the total alkalinity, both the bicarbonate alkalinity and cyanurate alkalinity will be measured, resulting in a reading that is higher than if CYA was not present. In order to determine bicarbonate alkalinity only, the procedure noted below should be followed:

1. Measure the cyanuric acid, total alkalinity and pH of the water as accurately as possible.
2. Determine the cyanuric acid factor (CAF) from the table in Appendix L with respect to pH.
3. Multiply the measured cyanuric acid concentration by the CAF to determine the amount of total alkalinity, which is due to cyanuric acid.
4. Subtract this amount from the measured total alkalinity to determine the measured "bicarbonate" alkalinity.

Example: Determining Alkalinity in a Pool with CYA

Water tests show that your pool water has a pH of 7.9, a total alkalinity of 130 ppm, and a cyanuric acid concentration of 100 ppm. What is the total bicarbonate alkalinity?

ANSWER:

From Appendix L: CAF is 0.35

Therefore:

Effect of cyanuric acid on total alkalinity

CAF x cyanuric acid concentration

$$0.35 \times 100 \text{ ppm} = 35 \text{ ppm}$$

AND

Total alkalinity - cyanuric acid effect = Bicarbonate alkalinity

130 ppm - 35 ppm = 95 ppm

As a result, the corrected alkalinity (bicarbonate) lies within the recommended operating range.

5. Lowering Total Alkalinity

To reduce excess alkalinity in the pool, one must **slug the acid** as opposed to feeding it through a chemical feeder or spreading the acid as you would do to lower the pH of the water. To slug the acid means to add the acid at three or four columns around the pool. This procedure concentrates the acid in the column thereby lowering the total alkalinity in that immediate area.

Total alkalinity is not appreciably reduced until the pH of a small volume of water is lowered to the 4 to 6 pH range. The alkalinity is removed from the column of water and allowed to mix with the remainder of the pool water to give an overall lowering effect.

By carrying out this procedure at different locations around the pool, the total alkalinity will be significantly reduced. The amount of acid to be used for this purpose can be determined by the table in Appendix C (1).

a. Chemical Equation for Lowering Alkalinity

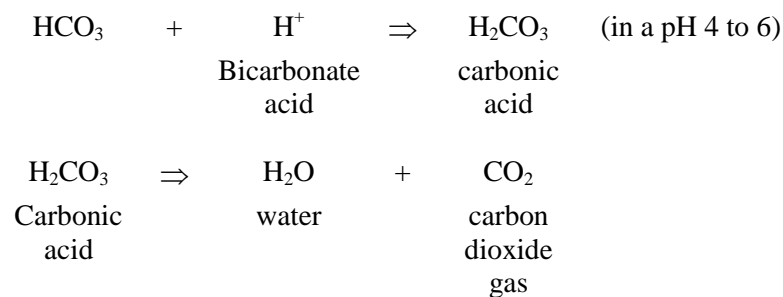

Note: If you review using CO₂ to adjust pH (see page 46), you will see that this is the reverse reaction.

b. Procedures for Slugging the Acid

Remember: Never slug acid in a pool when it is open to the public!

1. Turn off the recirculation system.
2. Always add acid to two or three locations in the deepest portion of the pool in a slow, careful manner so that acid does not lie on the pool bottom. To prevent damage to the pool bottom, slugging should not be done in the shallow end of the pool.
3. Never over treat with acid.

Acids used to reduce total alkalinity are usually either **muriatic acid** or **sodium bisulphate**. These acids are readily available on the market from your chemical supplier in the form of various trade name products. Muriatic acid is a liquid and sodium bisulphate is a dry powder.

When adding acid to reduce total alkalinity it is recommended that the addition be as follows:

- 50% of acid on Day 1
- 25% of acid on Day 2
- 25% (or remainder) of acid on Day 3

Chemical addition to a hot tub can be done over an hourly basis to ensure proper mixing of chemicals due to the higher turnover rate.

Example: Reducing Total Alkalinity

A 20 000 litre pool has a total alkalinity level of 220 mg/L. The required alkalinity range is between 80 - 120 mg/L and therefore must be reduced by 100 mg/L.

Using the table in Appendix C (1), determine how many litres of muriatic acid are required and what procedure should be used to add the acid.

Answer: 3.25 litres of muriatic acid should be added using the slugging procedure.

6. Raising Total Alkalinity

When total alkalinity is too low, sodium bicarbonate (baking soda) should be used to increase the total alkalinity. Sodium bicarbonate will increase the total alkalinity of the water with little effect on the pH.

Appendix C (2) indicates the correct amount of sodium bicarbonate to be used to increase total alkalinity to the required range.

B. Calcium Hardness

Hardness is defined as a characteristic of water that represents the concentration of calcium (Ca⁺⁺) and magnesium (Mg⁺⁺) ions. It is important to note that in swimming pool water chemistry, **only calcium hardness is of great importance**. Ensure that your pool test kit is measuring calcium hardness and not total hardness.

1. The Ideal Range for Calcium Hardness

Calcium hardness concentrations are expressed in parts per million (ppm). The desirable swimming pool range for calcium hardness is between 125 - 275 ppm.

2. Problems Calcium Hardness Can Cause in Pools

Low calcium hardness levels can cause “aggressive water” that may etch plaster, pitted metal fittings or make pool surfaces rough.

High calcium hardness levels can cause scale formation, formation of blockages, reduced circulation, heater inefficiency and cloudy water.

3. Adjusting Calcium Hardness

Hardness may need to be increased or decreased to prevent damage to pool equipment.

a. Increasing hardness

The chemical used to increase calcium hardness is calcium chloride dihydrate.

b. Decreasing hardness

Hardness removal can be expensive; however treatment of pool water with sodium hexametaphosphate (S.H.) may help correct the problems associated with high calcium hardness. The suggested treatment is 172 grams of S.H. for every 27 500 litres of water (6 ounces for every 7 265 gallons of water) initially. This

is to be followed by the addition of 21.5 grams per 27 500 litres of water (0.76 ounces for every 7 265 gallons of water) every second week during the season.

This treatment prevents scale formation, cloudiness and precipitation of calcium and other hardness producing compounds.

C. **Langelier's Saturation Index**

In 1936, Dr. Wilfred F. Langelier of the University of California, Berkeley developed a formula to assess the chemical composition of pool water to determine if it is balanced. This formula takes into account the pH, alkalinity, calcium hardness and temperature to determine whether the pool water is corrosive, scale forming or balanced. When the numbers are plugged into the formula and the calculation is done, a final number called the **saturation index** is achieved. A saturation index of +0.3 or higher indicates the water is scale forming. If the result is -0.3 or lower, the water is corrosive. A saturation index between -0.3 and +0.3 is said to be balanced.

The Langelier's index formula is as follows:

$$\textit{Saturation Index (S.I.)} = \textit{pH} + \textit{TF} + \textit{CF} + \textit{AF} - 12.1$$

Where:

TF = temperature factor
CF = calcium hardness factor
AF = total alkalinity factor

The number for pH used in the Langelier's calculation is a direct measure of the pool water pH as determined by a test of a pool sample. Temperature, alkalinity and hardness must also be tested, but these results are not used directly in the calculation. Instead, a 'factor' for each of these components must be used. These factors are found in a 'factor table' as noted below.

Factor Table

Temperature (°C)	TF	Calcium Hardness	CF	Total Alkalinity	AF
0	0.0	5	0.3	5	0.7
3	0.1	25	1.0	25	1.4
8	0.2	50	1.3	50	1.7
12	0.3	75	1.5	75	1.9
16	0.4	100	1.6	100	2.0
19	0.5	150	1.8	150	2.2
25	0.6	200	1.9	200	2.3
29	0.7	300	2.1	300	2.5
34	0.8	400	2.2	400	2.6
41	0.9	800	2.5	800	2.9
53	1.0	1000	2.6	1000	3.0

Example of Saturation Index Calculation:

Tests of a water sample show that the pH is 7.8, total alkalinity is 120 ppm, calcium hardness is 300 ppm and the temperature is 30 degrees Celsius. Based on the factors as found in the factor table, the total alkalinity factor is approximately 2.1, the calcium hardness factor is 2.1 and the temperature factor is 0.7. Plugging the numbers into the formula $SI = pH + TF + CF + AF - 12.1$ gives the following calculation:

$$SI = 7.8 + 2.1 + 2.1 + 0.7 - 12.1$$

$$SI = 12.7 - 12.1$$

$$SI = 0.6$$

In this example the saturation index is +0.6, indicating the pool water to be scale forming.

If the pH of the water was lowered to 7.3 in this example, the resulting equation would be:

$$SI = 7.3 + 2.1 + 2.1 + 0.7 - 12.1$$

$$SI = 0.1$$

After lowering the pH to 7.3, the resulting saturation index is now + 0.1 indicating the pool water is balanced.

D. Total Dissolved Solids

Total dissolved solids (TDS) is a combination of all the dissolved minerals, body oils and other similar dissolved materials in the water. TDS levels should be kept below 1500 parts per million (ppm). If levels get too high, the following problems may occur:

- ◆ eye irritation
- ◆ scale formation
- ◆ decrease in effectiveness of chlorine disinfection
- ◆ water cloudiness

TDS levels tend to increase over time due to the following reasons:

- ◆ addition of pool chemicals
- ◆ bather load
- ◆ dirt and other contaminants entering the pool

TDS also increases as water evaporates from a pool. It will increase faster in hot pools and outdoor pools due to high evaporation rates..

The only way to lower TDS is to drain a large volume of the pool and replace it with fresh water. There are methods of testing TDS, but it is not a common test for pool operators. If you suspect a problem with high TDS because of cloudy water and all other causes have been ruled out, contact your local health inspector or your pool chemical supplier for information on testing.

Please note, if you have a salt water pool, the TDS reading will include the salt. The TDS level of 1500 ppm is exclusive of the added salt. For instance, a salt water pool with 3000 ppm of salt does not have a TDS problem if the test shows less than 4500 ppm TDS.

E. Test Kits

Every responsible swimming pool operator must have an accurate test kit in order to determine the chemistry of the pool water to ensure that it remains balanced and safe for the bathers. A number of different test kits are available on the market. Any test kit being used must be able to determine free available chlorine, total available chlorine, pH and total alkalinity. If cyanuric acid (CYA) is used in the pool to stabilize the chlorine, the test kit must also be able to check for CYA.

Types of test kits include:

- Colorimetric test kits
- Titration test kits
- Test strips, and
- Photometric kits.

For any test kit being used, it is imperative that the manufacturer's instructions are followed in order to have accurate and meaningful results. If the test results are inaccurate, any chemical additions done that are based on those results could make the pool water worse for the bathers and could adversely affect the pool equipment and basin.

The most common test kit used by pool operators is a colorimetric kit. In such kits, chemical reagents are added to a pool water sample and the resulting colour change is compared to a standard colour wheel or other similar device. When such kits are used, it is important to store the reagents at proper temperature, otherwise they may lose their accuracy. The sample vials may become discoloured over time and should be changed if this occurs. Rinse the test vials out with tap water after each use. Do not pour the solutions back into the pool after the tests are done – they should be poured down a sanitary sewer drain.

Occasionally when performing these tests, an unusual colour may be seen. This usually means the water chemistry is off in some manner. When this occurs, refer to the test kit instruction manual in order to determine the true concentration of the chemical being tested.

F. Summary - Chemical Balances: Total Alkalinity and Calcium Hardness

Alkalinity exists in three basic forms: bicarbonate, carbonate and hydroxide. A correct total alkalinity level will aid in pH control. The ideal range for alkalinity is between 80 - 120 mg/L.

Excessive alkalinity is reduced by adding acid described in the slugging procedure.

Sodium bicarbonate (baking soda) is used to increase alkalinity.

Total hardness refers to the total concentration of Ca^{++} and Mg^{++} ions in the water. In swimming pool water chemistry, only the calcium hardness is of great importance. Calcium hardness should be kept in the range between 125 - 275 mg/L.

Waters vary tremendously with respect to calcium hardness. Calcium chloride dihydrate can be used to increase hardness and sodium hexametaphosphate is used to prevent problems associated with high hardness.

Regular testing of water chemistry must be performed following the test kit instructions precisely. Tests performed incorrectly will cause inaccurate readings. Any adjustments made to the pool chemistry based on false test results may make the pool water worse.

G. Review Questions: Chemical Balance: Total Alkalinity and Calcium Hardness

1. When pH of the pool water fluctuates or “bounces”, what is the likely cause?

2. What is the ideal range for calcium hardness in pool water?

3. If your pool test shows your alkalinity to be 60 ppm, what chemical would you add to the pool? How would you add it?

**Biologically Safe
Pool Water**

BIOLOGICALLY SAFE POOL WATER

PART 1: WATER DISINFECTION

A disinfectant is a chemical that is capable of destroying micro-organisms, algae and organic substances. Disinfectant residuals must be maintained in pool water in order to ensure that it is biologically safe for swimmers (free of pathogens).

Disinfection must be continuous when a swimming pool is in use; automatic disinfection is required.

The Regulation also requires that certain tests be done by the pool operator, on a routine basis, to ensure that the water remains biologically safe.

Most pool-associated disease outbreaks are the result of insufficient disinfection of the pool water. Where excessive bather loads or other sources of organic loading (faecal accidents) are noted, additional attention must be placed on the operating procedures to ensure micro-organisms are eliminated.

A. Requirement for Disinfectant Levels in Pool Water

The Regulation requires that the disinfectant residual level in a pool must be sufficient to maintain the pool water in a bacteriologically safe condition. Optimum operation shows that levels should not be less than the following:

- 1.0 mg/L (ppm) in a pool with an operating water temperature of 30 degrees Celsius or less.
- 2.0 mg/L (ppm) in a pool operating with a water temperature of more than 30 degrees Celsius.
- Pools that has an ORP value of 700 mV or more may be operated with a residual of 0.5 mg/L (ppm).

For hotel, motel and other high patron pools (especially those with small volume) it may be necessary to increase the chlorine concentration further. Assess the volume and bather loading for each pool and increase the residual accordingly. Free chlorine residuals can be maintained up to 10 ppm without adverse effect upon swimmers as long as proper water chemistry balance is maintained.

B. Bacteriological Water Sample Analysis

Pool operators should submit weekly water samples to the Provincial Laboratory for bacteriological analysis. The local Health Authority is notified when an “unsatisfactory result” is

obtained from one of these samples. The weekly sample results, in addition to inspection results, are used to assess the quality of water in your pool.

1. Unsatisfactory Water Sample Results

The following criteria are used to determine if a water sample result is unsatisfactory.

a. Heterotrophic Plate Count

This is a general bacterial count, measured as Colony Forming Units (CFU) per ml, and interpreted as bacteria per mL. This includes pathogenic (disease causing) and non-pathogenic bacteria. Levels over 100 CFU/ml constitute an unsatisfactory sample. An unsatisfactory HPC count indicates ineffective disinfection.

b. Coliform Bacteria

Coliforms are bacteria found in the intestinal tract of warm-blooded animals. Their presence in pool water may indicate contamination by feces. The presence of any coliforms is unsatisfactory in a sample.

c. Pseudomonas aeruginosa

This bacterium is tested in pools kept at temperatures above 30°C. Pseudomonas is common in the environment and can be introduced to the pool from bathers. Pseudomonas grows best at 30°C or above; thus, is most problematic in whirlpools, toddler pools and therapy tubs. Pseudomonas can cause folliculitis (infection of hair follicle), dermatitis (skin rash), and otitis externa (ear infection).

Pseudomonas can also form biofilms (slime layer). Biofilm protect bacteria from chlorine disinfection. Once a biofilm has formed, it is difficult to eliminate.

Biofilms are a constant source of harmful bacteria in a pool. Any presence of Pseudomonas in a sample is unsatisfactory and should be eliminated immediately.

Any of these results indicate inadequate disinfection of pool water or improper sampling technique. Whenever unsatisfactory results are received by the Health Agency, a Public Health Inspector will contact the operator and advise him/her of the necessary action.

2. Proper Sampling Technique

1. Wash your hands.
2. Use sample bottle for “Bacteriological Examination of Water” supplied by the Regional Health Authority.
3. Remove the cap from the bottle, being careful not to touch the mouth of the bottle or the inside of the cap.
4. Choose a sampling location near a skimmer, if applicable, or anywhere in a pool with a gutter system.
5. Plunge the bottle into the pool until your arm is almost fully submerged. Be sure not to spill the chemical powder/pill from the bottle. Be careful to always move the mouth of the bottle forward, so that water passing over your hand will not contaminate the sample. Move the bottle slowly, until it is filled to between the fill line marked on the bottle and the top of the bottle. If the bottle is overfilled, start over again with a new bottle.
6. Replace the cap immediately.
7. Attach the identification label from the requisition form to the sample bottle. Complete the requisition form, ensuring to fill in the date and time. Remember to add the “access code”. Place the bottle and completed form in the shipping bag or container.
8. Refrigerate the sample until delivery.

The sample will not be processed if the bottle is not labelled; the form is not submitted or not filled out completely.

For further information on water sampling, including drop off locations for samples taken in the Calgary Health Region, please see Appendix B.

It must be stressed that bacteriological testing is a confirmation of the operation of the pool on the date of the sampling only. Results are reported two to three days after sampling and as a result cannot be relied on for immediate feedback on the operation.

C. The Theory of Chlorination

When chlorine is added to the pool water, it reacts as follows:

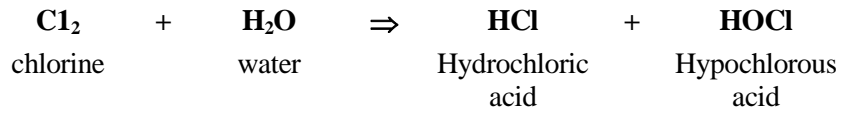

The hydrochloric acid formed is not a disinfectant and tends to lower the pH of the water.

Hypochlorous acid (HOCl) is a strong disinfectant. This acid ionizes in a high pH solution to:



The ionized form (OCl⁻) is about 1/100th the strength of hypochlorous acid (HOCl).

1. The Effect of pH on Chlorine Effectiveness

The degree of ionization is strongly affected by pH.

<u>pH</u>	<u>Hypochlorous acid (HOCl)</u> (active oxidizing agent)	<u>Hypochlorite Ion (OCl⁻)</u> (Inactive agent)
7.0	78%	22%
7.5	50%	50%
8.0	21%	79%
9.0	1%	99%

The above table shows that as the pH increases, the percentage of the active disinfectant (HOCl) decreases and the inactive form (OCl⁻) increases. This is why it is necessary to keep the pH as low as is comfortable for the bathers

2. Chlorine disinfection terminology

a. Chlorine Demand

The chlorine in hypochlorous acid is an active oxidizing agent combining readily with other substances. Swimming pool water contains many different substances: bacteria, body oils and wastes, and organic matter such as leaves, etc.

The hypochlorous acid combines with many of these substances and oxidizes them, but in the process is used up. The amount of chlorine which must be added to a

pool at any given moment to react with all of these substances is called the **chlorine demand**.

b. Free Chlorine Residual

After the chlorine demand has been satisfied, additional chlorine is added so that chlorine is readily available when other wastes or contaminants enter the pool. The amount of chlorine not yet used is called **free available chlorine (FAC)**. It includes both the hypochlorous acid and the hypochlorite ion. The test kit result for FAC does not distinguish between the two forms of chlorine.

c. Combined Chlorine

Residual chlorine may combine with nitrogen-containing substances, such as ammonia or organics containing nitrogen, to produce compounds called **chloramines** or combined chlorine. The most common sources of ammonia and/or nitrogen containing organic contaminants in your pool are urine, sweat, and the environment.

Combined chlorine (CC) is much more stable than free chlorine, but is far less effective as a disinfectant (only 1/12th as effective). In addition, they can result in eye irritation and the so-called chlorine odour in the pool area. For these reasons, chloramines are considered a nuisance for pool operators.

Do not allow the combined chlorine level to exceed 1.0 ppm in your pool. This will reduce the number of complaints from patrons regarding odour problems and eye or skin irritations.

d. Total Chlorine

Total chlorine (TC) is the sum of the free available chlorine residual and the combined chlorine.

$$\text{TC} = \text{FAC} + \text{CC}$$

Example: Determining Combined Chlorine from Total Chlorine and Free Available Chlorine

If the total chlorine in a pool is 1.5 mg/L and the free available chlorine is 0.2 mg/L, the combined chlorine is calculated to be 1.3 mg/L.

When you order supplies for your test kit, make sure to order both free and total chlorine reagents.

3. Shocking

As mentioned earlier, combined chlorine residuals (chloramines) tend to form in swimming pool water over time causing eye irritation and chlorine odour. These can be eliminated by a treatment called shocking.

a. Shocking with Chlorine

Break point chlorination is the process of raising the free available chlorine concentration to 10 times the combined chlorine level measured in the water. This high dosage of chlorine will “shock” the pool and burn off the ammonia-based compounds.

b. Non-chlorinated Shock

An alternate method of shocking is to use a non-chlorinated oxidiser (typically **monopersulfates**). Non-chlorinated shock chemicals are oxidisers that are strong enough to react with chloramines but will not kill any bacteria. Note that monopersulfates will interfere with tests for combined chlorine. For more information on this chemical, please see the “Other Chemicals” section in this manual.

c. When to Shock

If the combined chlorine residual is calculated to be 1.0 ppm or more, the pool requires shocking. As noted earlier, if a non-chlorinated shock chemical is used in the pool, the regular test method for combined chlorine will not be accurate. If such products are used, a test kit that distinguishes the interference of the non-chlorinated shock should be used.

4. Superchlorination

Superchlorination is the process of increasing the amount of free available chlorine to increase the level of disinfection in your pool. Superchlorination may be done for several reasons:

- To eliminate chlorine resistant organisms such as *Pseudomonas aeruginosa*

- To break down a biofilm
- To disinfect following a fecal event (the procedure for disinfection will be covered later in the manual)
- To disinfect following contamination by blood or body fluid
- To eliminate algae
- To disinfect following a large bather load

Superchlorination is achieved by increasing the free available chlorine (FAC) in the pool far above the normal amount. Depending on the reason for superchlorinating, the FAC could be increased anywhere from 8 ppm to 50 ppm. This process must be done with chlorinated products, not non-chlorinated shock products.

When a pool is superchlorinated after a fecal accident, the high concentration of chlorine must remain in the water for a given amount of time to achieve thorough disinfection. The combination of time and concentration of chlorine is known as the **CT value**. The 'C' stands for the concentration of free chlorine (as measured in ppm) and 'T' stands for time (measured in minutes).

For example, a CT value of 15300 must be achieved for a chlorine treatment after a diarrheal incident in a pool. This value can be achieved if a free chlorine residual of 50 ppm is maintained in the water for 306 minutes (just over 5 hours).

$$CT = \text{concentration} \times \text{time}$$

$$CT = 50 \text{ ppm} \times 306 \text{ minutes}$$

$$CT = 15300.$$

For any given CT value, if the dosage of chlorine is raised, the amount of time needed to achieve the CT value would decrease. For instance, in the above example, if the chlorine concentration was doubled to 100 ppm, the amount of time to reach the CT of 15300 would be reduced by half (153 minutes).

5. Basic Formula for Chlorinating

If chlorine is added to shock the pool, to superchlorinate, or simply to add chlorine after a drain and refill, the basic formulas found below can be used to determine the desired chlorine to be added depending upon the type of chlorine product used. (The different types

of chlorine products will be discussed in greater detail in the following section of this manual.)

a. Using Sodium Hypochlorite (liquid):

$$\frac{\text{Litres of pool water} \times \text{desired chlorine dosage (ppm)}}{10,000 \times \% \text{ chlorine in sodium hypochlorite}} = \text{litres of sodium hypochlorite}$$

b. Using Calcium or Lithium Hypochlorite or Gas Chlorine (solid):

$$\frac{\text{Litres of pool water} \times 1\text{kg/L} \times \text{desired Cl}_2 \text{ dosage (ppm)}}{10,000 \times \% \text{ of available chlorine in product}} = \text{kilograms of chlorine}$$

Example: Shocking a Pool with Sodium Hypochlorite

A pool containing 522 100 litres (115 000 gallons) of water is to be shocked to 15 ppm using 12% sodium hypochlorite. Calculate the amount required.

(Note: The present chlorine level is 0 mg/L.)

$$\frac{522\ 100 \text{ litres} \times 15 \text{ ppm}}{10\ 000 \text{ ppm} \times 12} = \text{L of sodium hypochlorite is required}$$

$$\frac{522\ 100 \text{ litres} \times 15 \text{ ppm}}{120\ 000 \text{ ppm}} = 65.26 \text{ L of sodium hypochlorite is required to shock to 15 ppm}$$

6. Dechlorination

Certain circumstances arise when the chlorine concentration in the pool water may be too high. For example, if an operator superchlorinates/shocks, the residual chlorine remaining in the water may be too high.

Two methods for lowering the chlorine residual in the water are by dilution and through chemical treatment.

a. Dilution

The first method is by simple **dilution**. To reduce the chlorine residual using this method, simply drain some water from the pool and top it up with fresh make-up water.

b. Chemical Treatment

The second method of dechlorinating pool water is by chemical means. **Sodium thiosulphate** and **sodium bisulphite** are dechlorinating agents that can be added to the pool water at a rate described on the manufacturer's label. The following example shows how to calculate the amount of sodium thiosulphate necessary to reduce the chlorine residual:

Example:

The volume of your pool is 150 000 Litres. The chlorine measurement reveals the following:

$$\text{FAC} = 15 \text{ ppm} \qquad \text{The desired FAC} = 2 \text{ ppm}$$

You are using sodium thiosulphate to dechlorinate. The label on the container of thiosulphate states: "120 grams of sodium thiosulphate per 200 000 litres of pool water will reduce chlorine by 1.0 ppm".

Question:

How much sodium thiosulphate must be added?

Answer:

Step #1

Determine the FAC reduction.

$$\begin{aligned} \text{FAC reduction} &= \text{measured FAC} - \text{desired FAC} \\ &= 15 \text{ ppm} - 2 \text{ ppm} = 13 \text{ ppm} \end{aligned}$$

Step #2

Determine the amount of sodium thiosulphate required in grams.

$$\begin{aligned} &= \frac{\text{g from label} \times \text{your pool volume} \times \text{desired reduction}}{\text{volume from label} \times \text{FAC ppm change from label}} \\ &= \frac{120 \text{ g} \times 150\,000 \text{ L} \times 13 \text{ ppm}}{200\,000 \text{ L} \times 1.0 \text{ ppm}} \\ &= 120 \text{ g} \times 0.75 \times 13 \\ &= 1170 \text{ g} = 1.17 \text{ kg} \end{aligned}$$

Allow sufficient time for the chemical reaction to take place prior to retesting.

Be careful not to add too much sodium thiosulphate, or you will have trouble producing a chlorine residual!

D. Summary - Biologically Safe Pool Water: Water Disinfection

A disinfectant destroys micro-organisms and must be used in pool water. Pool water must be tested every week for bacteriological quality.

Superchlorination of the pool water is required when an unsatisfactory bacteria result has been detected or a fecal accident has occurred in a pool.

Shocking will remove chloramines (combined chlorine) from pool water.

Dechlorination can be achieved by diluting water or adding a dechlorinating agent such as sodium thiosulphate.

E. Review Questions: Biologically Safe Pool Water: Water Disinfection

1. What level of chlorine residual is required in swimming pools?

2. What are coliform bacteria?

3. Which form of chlorine is a potent disinfectant?

4. Define chlorine demand.

5. How often does a water sample need to be submitted for bacteriological testing?

PART 2: TYPES OF CHLORINE DISINFECTANTS

Chlorine disinfectants are available in many forms and may be added to a pool by various methods in order to destroy micro-organisms. Each chlorine product has different chemical properties, such as pH, which will affect the water chemistry. Generally speaking, chlorine can be divided into two main categories:

- Unstabilized chlorine
- Stabilized chlorine

Unstabilized chlorine compounds are the most commonly used and include such products as:

- | | |
|--|---------|
| • Gas chlorine: | pH < 1 |
| • Calcium hypochlorite (powder and tablets): | pH 11.8 |
| • Sodium hypochlorite (liquid): | pH 13.0 |
| • Lithium hypochlorite (powder): | pH 10.7 |

Stabilized chlorine compounds are disinfectants which have cyanuric acid (a stabilizer) added to prevent chlorine loss from reaction with sunlight. They are available on the market in various forms. **Stabilized chlorine compounds cannot be used with a mechanical feed system. Also, stabilized chlorine is only for use in outdoor pools.**

Supplemental disinfectant methods and products can also be used, but only in conjunction with chlorine or bromine products.

A. Unstabilized Chlorines

1. Gas Chlorine

a. Properties

Under normal conditions, elemental chlorine is a gas that is heavier than air, greenish in colour, is extremely toxic and has a very irritating odour. This gas liquefies under high pressure and is therefore sold commercially as a liquid under high pressure in steel cylinders. Rupture of such a cylinder would release enough of this toxic gas to cause death to many people.

Gas chlorine is a highly efficient method of swimming pool disinfection, but **it is dangerous and requires extra care and training if used.**

The available chlorine content of chlorine gas is 100%.

b. How Gas Chlorine is Used

Gaseous chlorine is supplied in steel cylinders under high pressure; the gas enters the main supply line to the pool via a demand valve and injector. Water flowing past the aperture of the injector produces a negative pressure on the gas supply line. This negative pressure activates the demand valve allowing gas to enter the line.

In order to keep all chlorine equipment (i.e. injector) in the chlorine room it is suggested that the water supply line be brought to the chlorine room.

The amount of gas that enters the system is controlled either by the operator, via a manual control valve, or by an automatic control valve. The automatic control valve constantly measures the amount of free chlorine available in the pool water and determines if sufficient gas is being added.

In this way, the pool operator or the automatic feeder will control the amount of gas entering the system during any specific period.

The pressure demand valve is a safety feature. Because it is activated by negative pressure, if recirculation stops or a line break occurs, the required negative pressure will not occur thereby shutting off the flow of chlorine gas.

c. Safety Rules

It is imperative that strict adherence to specific safety rules be followed. These are:

- i.. Chlorine cylinders should always be stored indoors in a fire-resistant building.
- ii.. Chlorine cylinders must be chained or strapped to a rigid support to prevent accidental tipping (even when empty).
- iii. Cylinders and chlorinator should be kept in a room by themselves and this room must have the following characteristics:
 - ◆ It **must** have a door that opens outwards to the outside air.
 - ◆ It **must** allow for visual inspection of the room from outside the room.

- ◆ It **must** have either continuous mechanical ventilation to the outside air, or be provided with screened vents located in or near the ceiling and within 150 millimetres (6 inches) of the floor.
- iv. Chlorine cylinders and the chlorinator should be checked daily for leaks. A small amount of commercial-grade ammonium hydroxide on a piece of cloth will produce white smoke in the presence of chlorine (combined chlorine).

Note: The lead washer, which forms the seal between the cylinder and the regulator, must be changed when you are changing the chlorine cylinder to ensure a tight seal is maintained.

- v. A gas mask approved for chlorine use must be conveniently located **outside** the chlorine room at all times. The canister type of gas mask is not recommended. A self-contained air breathing apparatus or air pack should be used for emergency purposes.

Note: There is no guarantee that activated charcoal canister masks will provide respiratory protection to the wearer in a chlorine gas atmosphere greater than 1%. There is also no specified safety time factor for the wearer.

It is absolutely essential that personnel handling chlorine gas be provided with maximum protection in the event of a chlorine gas leak. Self-contained air breathing apparatus is available for emergency use in either 15 or 30 minute air packs, and when used properly, will give the wearer the confidence to do the job properly by supplying sufficient guaranteed air time.

The cylinder of chlorine in use should be chained upright on a scale so that the pool operator will have a daily check of how much chlorine has been used and how much remains in the cylinder.

d. Emergency Procedure

Adequate knowledge of the effect of chlorine gas is necessary so that proper procedures can be taken should a leak occur. It is interesting to note that it takes only:

- 4 mg/L chlorine before you can smell it;
- 15 mg/L to cause throat irritation;

- 30 mg/L chlorine to make you cough;
- 40-60 mg/L to be dangerous in 30-60 minutes; and
- 1,000 mg/L to kill you in a few breaths.

1,000 mg/L is the equivalent of 0.1% chlorine gas in the air. It does not take much chlorine gas to kill!

It is also necessary to know the equipment and how to isolate it quickly and carefully. Proper safety precautions must be taken and the following steps adhered to should you smell a leak:

CALL 911!

- i. Do not enter the gas chlorine room if your clothing or skin is wet.
- ii. Evacuate the pool and the immediate area downwind of the gas leak.
- iii. **Put on an air pack.**

Note: The air pack should be located within 5 meters of the door leading to the chlorine room.

- iv. If your chlorine room has one, turn on the exhaust fan. Check fan discharge point and be sure personnel or equipment are not in the way. If there is a casualty, remove him/her immediately and apply first aid.
- v. Shut off cylinder(s). Remember, if the leak is large, or if the equipment has been leaking for some time, the room will be full of gas. **Do not attempt a repair unless you are trained and even then, never alone.**
- vi. Notify supervisor and the fire department immediately so that qualified people can repair the leak.

2. Calcium Hypochlorite

a. Properties

Calcium hypochlorite is a dry, white compound available in granular or tablet form. It contains approximately **65% available chlorine** by weight and will remain relatively stable if kept dry and cool.

The use of calcium hypochlorite generally will raise the pH of the pool water and adds considerably to the alkalinity and hardness of the water over time. This may necessitate the use of muriatic acid or sodium bisulphate for pH control.

b. How Calcium Hypochlorite is Used

Granular calcium hypochlorite is dissolved in water and fed in liquid form through a **hypochlorinator** into the pool recirculation line. However, upon dissolving, a heavy precipitate of calcium carbonate forms. This precipitate will clog the hypochlorinator and increase the calcium hardness and the total alkalinity levels in the pool water. For these reasons, the precipitate should not be added to the pool.

Elimination of most of the precipitate can be accomplished by mixing in one container, allowing the precipitate to settle, and siphoning the clear liquid into a second container. It is from the second container that the hypochlorinator should be drawn from. If the hypochlorinator does clog, it can be rectified by acid washing.

Pictures of Calcium Hypochlorite Feed Systems

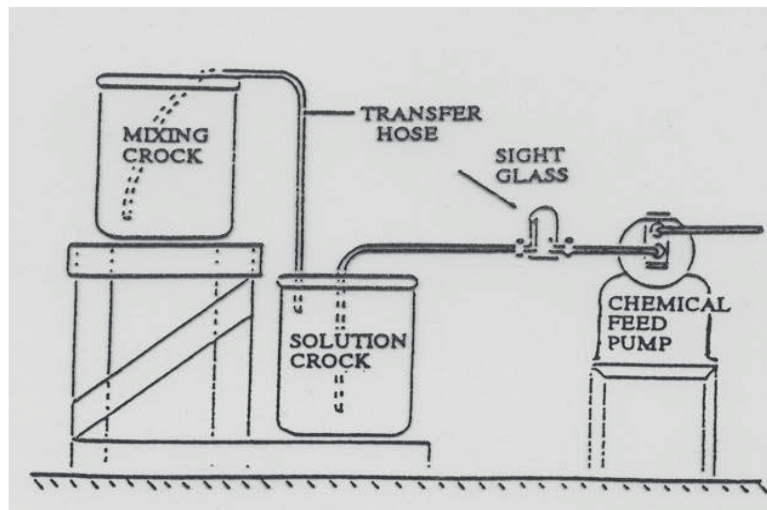



c. Safety Rules

Calcium hypochlorite is very hazardous due to its highly reactive nature as an oxidizing agent. A small amount of soft drink or any kind of beverage accidentally added to it could cause an explosion that may result in personal injury and property damage. For this reason, empty calcium hypochlorite containers should never be reused.

Contact with any of the materials listed below can result in a fire or explosion:

- Cigarettes
- Oil or grease
- Beverages
- Paint thinner
- Solvents
- Rags
- Paper
- Cosmetics
- Suntan lotions and creams
- Blood
- Dead vegetation and other organic material

The following precautions should be taken when using calcium hypochlorite:

- i. Read the container label carefully prior to using the product and carefully follow instructions while using it.
- ii. Mix only with water.

Always add chemical to water, never water to chemical!
- iii. This product is a powerful oxidizing agent, so keep it away from combustible materials and do not contaminate it with foreign matter. A fire of great intensity may result.
- iv. The safest way to store calcium hypochlorite is in a closed fibre or a plastic container. Never store other pool chemicals in a container previously used to store calcium hypochlorite.
- v. Use only a clean, dry cup to measure calcium hypochlorite.
- vi. Always wear gloves and an apron when handling calcium hypochlorite.
- vii. Do not inhale the dust when mixing or pouring the granular powder. Always use a dust mask.
- viii. Do not mix with household products, acids, solvents, or other pool chemicals.
- ix. Store in a cool, dry place in the original container and always replace the cover.
- x. Do not drop, roll or skid the container and always keep it upright.
- xi. Do not reuse empty calcium hypochlorite containers.

d. Emergency Procedure

If a fire or explosion should occur, evacuate the swimming pool area and call the local fire department. Extinguishers of the vaporizing-liquid type, such as carbon tetrachloride, **must not** be used on fires involving calcium hypochlorite as a more serious fire may result.

If this product is accidentally ingested, call poison control. If this product comes in contact with skin, flush with a large amount of water for 15 minutes.

3. Sodium Hypochlorite

a. Properties

Sodium hypochlorite is a clear, slightly yellow liquid solution that is used in diluted form as common household bleach (5% chlorine). In its commercial form, it contains **12-15% available chlorine**. Sodium hypochlorite is relatively unstable, and will quickly lose its strength if stored in sunlight.

It is strongly basic in nature, which will generally cause an increase in pH and add to the alkalinity of the pool water. This may necessitate the use of muriatic acid or sodium bisulphate for pH control.

b. How Sodium Hypochlorite is Used

Sodium hypochlorite does not form a precipitate or sediment and therefore can be fed directly through the **hypochlorinator** as is, or diluted to any desired concentration. Scaling of the feed tube or pump may occur and result in blockage of the chemical feed. If this occurs, dilution of the sodium hypochlorite in the storage bin may be required.

Picture: Sodium Hypochlorite Tank and Hypochlorinator



c. Safety Rules

Gloves and an apron should be worn when handling this chemical. Spillage on the skin should be washed off with copious amounts of water. Sodium hypochlorite is corrosive in nature and should be handled with care.

**** Contact with acid will result in the release of gaseous chlorine. ****

Handle and store sodium hypochlorite as per manufacturer instructions. **Always add chemical to water, never water to chemical.**

4. Lithium Hypochlorite

a. Properties

Lithium hypochlorite is a white, relatively odourless, granular substance. It is completely and readily soluble in water and does not produce a turbid residue even in pool water with a high pH or total alkalinity, nor does it bleach pool liners.

Lithium hypochlorite is safe and easy to handle primarily because there is no pre-mixing required. This hypochlorite product contains **35% available chlorine** and is quite stable for prolonged storage.

Lithium hypochlorite has a pH of 10 and consequently will raise the pH of the pool water making it necessary to add muriatic acid or sodium bisulphate for pH control.

b. How Lithium Hypochlorite is Used

Lithium hypochlorite dissolves completely in water and therefore can be fed directly through the hypochlorinator.

c. Safety Rules

The following are safety precautions to follow when handling lithium hypochlorite:

- i. Gloves, apron, safety glasses and a dust mask should be worn.
- ii. The manufacturer directions shall always be followed.

5. Salt Generated Chlorine

The salt generated chlorine process uses free available chlorine (HOCl) produced from the electrolysis of salt water. When electricity is passed through salt water (2 NaCl and $2 \text{ H}_2\text{O}$), the atoms dissociate into NaOCl (sodium hypochlorite) and H_2 (Hydrogen). Sodium hypochlorite is dissolved in water, and used to create free available chlorine (HOCl) used for disinfection.

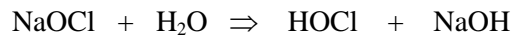
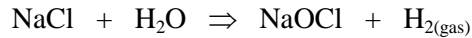

Thus, there is a tendency for salt generated chlorine systems to increase the pH of water (around 8.0) and require lowering with an acid.

Diagram: Disinfection System Using Salt

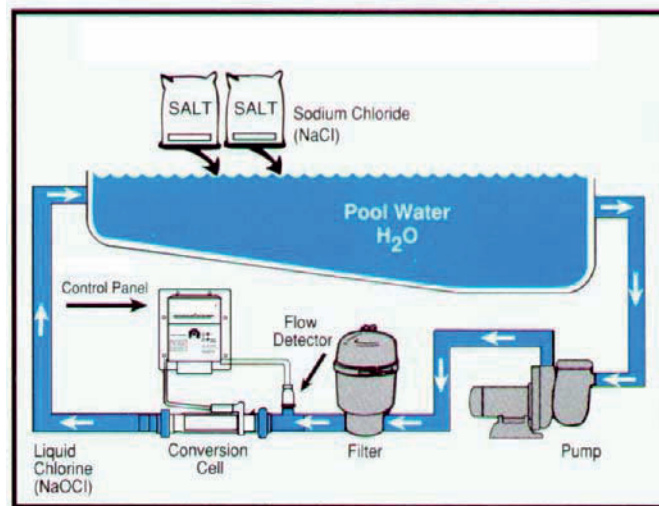

a. How Salt Generated Chlorine is Used

Commercial salt water systems use low levels of salt at a minimum of 0.3% or 3000 ppm (one third as salty as your own teardrop).

Please note that salt can be purchased in two forms, stabilized (i.e. with cyanuric acid added) and unstabilized (plain, non-iodized salt). Stabilized is not to be used in an indoor pool.

The system consists of:

- a power supply,
- control panel, and
- electrolytic cell.

A portion of the salty pool water passes through the electrolytic cell(s) producing the chlorine that is re-introduced into the water as a disinfectant.

Safety features include water flow, gas and temperature sensing with provision for addition of a pressure switch or other protective devices.

The electrolytic cell should be fitted in a bypass situation to allow for servicing without turning off recirculation system.

b. Advantages

- No handling or storing of chlorine
- Fully automatic, safe and simple to use
- Non irritating to skin and eyes
- Sparkling clear pool water
- Mild salt water has received positive feedback from bathers (buoyancy, non drying to skin, etc)

c. Disadvantages

- Initial installation costs are high (thus a tendency to undersize by owners)
- Slow to respond to large chlorine demands (may be compensated with a liquid feed pump for peak demand periods)
- Salt levels must remain constant or damage to electrochemical cell may result
- Use on small volume whirlpools is not practical due to frequency of changing water.
- Cell can experience mineralization on electrochemical plates (especially where water has excessive contamination such as whirlpools)
- Systems are not practical for superchlorination due to the time required to raise the free chlorine level.

Picture: 5 lb Chlorine Generation Cell



Picture: Control Panel and Electrolytic Cells



B. Stabilized Chlorine

Ultraviolet (UV) rays from sunshine react with chlorine in outdoor pools, depleting the chlorine residual. Sunlight through windows in an indoor pool is not a concern as the glass blocks the UV rays. The chlorine loss in an outdoor pool can be significantly reduced by the addition of a chlorine stabilizer such as cyanuric acid. This chemical will bind with chlorine to create a more stable chlorine compound. Pre-formed stabilized chlorine compounds are also available. These contain both the disinfectant and stabilizer in one product.

1. Stabilized Chlorine Compounds

Stabilized chlorine chemicals are the chlorinated salts of isocyanuric acid. They contain both the disinfectant and the stabilizer in one compound.

Stabilized chlorine compounds are marketed under a variety of brand names. The generic compounds in common use are:

a. Trichlor

Trichloro-isocyanuric acid or Trichloro-s-triazinetriene (Cl_3NCO_3)

Minimum 90% available chlorine. It is found in tablet/puck form, and usually used with erosion feeders. It is acidic and will lower the pH of the pool.

b. Dichlor

These products come in various chemical forms:

i. Sodium-dichloro-isocyanurate or Sodium-dichloro-triazine-trione ($\text{Cl}_2\text{Na}(\text{NCO}_3)$)

Minimum 63% available chlorine. This is a dry granulated product that mixes well into water, and is applied by pumping this mixture into the pool service line. It is pH neutral.

ii. Potassium dichloro-isocyanurate or potassium dichloro-s-triazinetriene ($\text{Cl}_2\text{K}(\text{NCO}_3)$)

Minimum 59% available chlorine. This is also a dry granulated product that mixes well into water, and is applied by pumping this mixture into the pool service line. It is also pH neutral.

These pre-mixed stabilized chlorine products are not intended for use in automated chlorination systems.

When these compounds dissolve, the stabilizing chemical enters the water and keeps accumulating over time. This results in the chlorine becoming over-stabilized and no longer effective as a disinfectant.

2. Cyanuric Acid (CYA)

The same stabilizing effect can be achieved by adding **cyanuric acid** (or isocyanuric acid) manually to pool water. The stabilizing chemical reacts with any unstabilized chlorine product that is used as a disinfectant. Cyanuric acid is a weak acid with virtually no effect on the pH of the pool water. In fact, another advantage of cyanuric acid is that it tends to keep the pH more stable.

3. Testing for Cyanuric Acid

Whether stabilizer is added to a pool using unstabilized chlorine or a stabilized chlorine compound is used, cyanuric acid should be kept at a concentration between the ranges of **25-35 ppm**. The concentration of cyanuric acid must not exceed 50 ppm. When chlorine is over-stabilized, it will cause a decrease in chlorine effectiveness called “chlorine lock”.

The only way to reduce the concentration of cyanuric acid is to drain some pool water and replace it with fresh water. If you use chlorine stabilizer in your outdoor pool, you must test it regularly. Test kits designed to measure cyanuric acid are available on the market.

Never superchlorinate or shock with a stabilized chlorine compound as this may cause the chlorine to become over-stabilized. Always use an unstabilized chlorine product, such as calcium hypochlorite.

C. Bromine

1. Stick Bromine

Bromochloro dimethylhydantoin - BCDMH
 $BCDMH + H_2O \rightarrow HOBr + HOCl + DMH$

HOBr disinfects and leaves Br^- which reacts with the HOCl (released from BCDMH) to form additional hypobromous acid (HOBr)

$HOCl + Br^- \rightarrow HOBr + Cl^-$ (debated whether this occurs)

a. properties

Stick Bromine, Bromo-chloro-dimethyl Hydantoin (BCDMH) is a solid white stick or puck. It is shelf stable and does not break down over time. It is soluble in water and produces hypobromous acid, HOBr, which is responsible for disinfecting the water.

In the solid form it contains up to 96% available Bromine. It is relatively pH independent which allows pools using bromine to operate up to pH 8 and still be effective. It is acidic but does not have a large effect on the overall pool pH. Continued use of BCDMH will result in a build-up of the organic DMH which must be shocked to keep the DMH residual below 200ppm.

Effects of pH on Bromine Effectiveness

HoBr %	OBr- %	pH
100	0	6
99.4	0.6	6.5
98	2	7
94	6	7.5
83	17	8
57	43	8.5

The above table demonstrates that bromine effectiveness is maintained at elevated pH levels and may be a more suitable disinfectant in water where high pH is a concern.

b. how stick Bromine is used

Stick bromine is fed to a pool through an erosion feeder. The stick bromine dissolves slowly to allow for a controlled rate of bromine to be fed to the pool.

Erosion feeders have the limitation of only being able to feed the dissolved Bromine that is contained in the erosion feeder. Depending on the size of the erosion feeder the amount of disinfectant may not be adequate and the feeding unit may require resizing. HOBr levels to 10ppm do not pose a health risk to the bather. Normal levels should be maintained at 2ppm – 2.5ppm

c. Safety rules

Contact with acids and oxidizers may generate heat and cause fires or explosions.

Advantages

- Shelf stable
- 96% available strength
- Relatively pH independent (pH 8 is ok)
- Combined bromine is an effective sanitizer
- Combined bromine has no odour
- Acts as a coagulant for undissolved solids

Disadvantages

- Slow dissolving (White solid stick)
- Destroys Alkalinity – results in pool damage
- Chemical cost is higher
- Will have to shock to burn off DMH build up (No test kit available for DMH)
- Can not be used for shock dosing because of the build up of DMH
- Destroyed by sunlight and can not be protected with CYA

D. Supplemental Disinfectants

Although chlorine or bromine is used as the primary disinfectant in licensed pools, alternative disinfectant treatments may be used in conjunction with chlorine or bromine to supplement disinfection.

1. Ozone

a. Ozone Properties

Ozone (O₃) is an unstable form of oxygen where three oxygen atoms are bonded together instead of two. Ozone is one of the most powerful oxidants and disinfectants known. Ozone is a colourless gas. It has a pungent sweet odour and is toxic at fairly low levels.

Ozone has a neutral effect on pH.

Ozone is created in nature by the combination of oxygen in air and the ultraviolet rays of the sun or by the corona discharge during a lightning storm. Corona Discharge technology is similar to the natural process of ozone production via lightning.

Ozone has three functions in swimming pools and whirlpools including disinfecting, partial oxidizing and complete oxidizing. Ozone is very unstable and will change to oxygen quickly; having a half-life of only seconds. In swimming pools and whirlpools, ozone must be used in conjunction with a chlorine disinfectant to ensure a residual can be measured.

i. Ozone as a Partial Oxidant

Although ozone has the ability to completely oxidize organic compounds, a majority of these compounds are only partially oxidized. This means that ozone reacts with organic material, thus changing its nature and overall charge in solution. The newly charged organic material interacts with oppositely charged particles (i.e. calcium, magnesium and flocculating agents) to form a larger mass of material. This material can then be filtered out through sand filtration. This process is commonly called micro flocculation.

ii. Ozone as a Complete Oxidant

Ozone has the ability to completely oxidize only a few organic compounds found in swimming pool and whirlpool water. In this process, organic material is "burnt off".

NOTE: The use of ozone will reduce the amount of organic material in pool water and the chlorine demand, which in turn, reduces chlorine consumption and other chemicals used with chlorine.

Currently, ozone is very popular in Europe for use in swimming pools and whirlpools and is now being used in North America. It should be noted that some pools in Europe have much stricter rules on discharge water and thus must maintain a lower chlorine level, which can be achieved through the use of ozone.

b. Ozone Generation

Ozone can be produced for swimming pool disinfection in two ways:

- **Corona Discharge:** subjecting dry air or oxygen to high voltage electricity. This method is capable of producing several pounds of ozone per day.
- **Ultraviolet Light:** subjecting dry air to ultraviolet radiation. This method can only produce several grams of ozone per day.

i. Corona Discharge

Using a Corona Discharge (CD) system, ozone is produced by passing air or oxygen through a high voltage electrical discharge (corona). A minimum of approximately 5 000 volts of electricity is necessary to create the corona (14 000 is a practical design maximum voltage). Air (containing 21% oxygen) or concentrated oxygen (95% pure oxygen) dried to a minimum of -60°C dew point passes through the corona which causes the O_2 bond to split, freeing two O_1 atoms which then collide with other O_2 molecules to create ozone (O_3).

Drying the air is done for two reasons:

1. The production of ozone is increased.
2. The formation of nitrogen oxides will be reduced. In the presence of moisture, these produce nitric acid which is corrosive. CD units are capable of producing significantly more ozone at higher concentrations than UV unit. For this reason CD units should be installed at swimming pools where larger amounts of ozone are required.

ii. Ultraviolet Light (UV) Generated Ozone

Ozone may be produced photochemically by passing an oxygen-containing gas through a high-energy radiation source of UV radiation having a wavelength of 185 nm (1 nanometre = 1/1 000 000 000 metre).

Only a very small portion of the oxygen will be converted to ozone in these systems. Therefore, only minimal amounts and concentrations of ozone are produced. Once the ozone has been produced, a venturi process will bubble ozone into the water.

The ozone gas produced by either method is injected into the pool return lines. Ozone is short-lived and because residuals are difficult to maintain, it must be used with another disinfectant to maintain a residual in the pool.

c. **Health Concerns with Ozone**

A pungent odour can be detected at concentrations between 0.01 and 0.04 ppm. At concentrations between 0.1 ppm - 1.5 ppm ozone will irritate the eyes and respiratory organs, and will cause headaches, vomiting and severe irritation of the bronchial passages.

Ozone is harmful if inhaled. Thus ozone must be removed from the water prior to being returned to the pool. Because of ozone's toxicity, commercial pools are usually required to have strict safety controls very much like those for gas chlorine. Ozone present in the air at levels of only 5 ppm is an immediate danger to life and health. Fortunately, ozone's odour can be detected at levels of less than 1ppm.

Breathing low levels of ozone may have both immediate and long term health effects. Low level exposure to ozone (0.12 ppm to 0.96 ppm) for 1 to 6 hours in the air has been shown to decrease lung function. The immediate health effects seem to

be reversible after the ozone exposure is terminated. Long term exposure to ozone has been associated with the build up of collagen. This causes thickening of the lungs, making it hard for them to remove bacteria and other micro-organisms, resulting in increased lung infections. Breathing slightly higher levels of ozone can create some irreversible effects on lung capacity, especially when breathing deeply.

At swimming pools and whirlpools with ozone generating equipment, there should be:

- no ozone in the pool/whirlpool basin water
- no ozone in the air above the pool/whirlpool water (off gassing)
- no ozone in the air of the rooms in which ozone is produced and used.

2. Chlorine Dioxide

Chlorine dioxide (ClO₂) is a synthetic yellowish-green gas with a chlorine like odour. ClO₂ is unstable as a gas and will undergo decomposition into chlorine gas (Cl₂), oxygen (O₂) and heat. However, ClO₂ is stable and **100% soluble in an aqueous solution**. For example, solutions of approximately 1% ClO₂ (10 g/L) may safely be stored if the solution is protected from light and kept chilled. In solution, ClO₂ exists as a true gas. The instability of ClO₂ has an important consequence. It negates the possibility of creating and transporting cylinders or rail cars of the gas. Instead **ClO₂ must be produced on site**.

Currently in North America, ClO₂ is used mainly as a primary disinfectant for surface waters with odour and taste problems. It is an effective disinfectant at concentrations as low as 0.1 ppm and over a wide pH range.

Some research indicates that chlorine dioxide may be effective at removing biofilm.

Chlorine dioxide gas can permeate the biofilm causing the biofilm to detach at various sites. The detachment can allow other oxidisers to react with the bacteria as well as provide means for the shear action of the water to aid in the removal of the biofilm.

ClO₂ reacts with the bacteria through oxidation (stealing electrons). The chlorine dioxide reacts to form chlorite (ClO₂⁻). Toxicological studies have shown that ClO₂'s disinfection by-product, chlorite, poses no significant adverse risk to human health.

a. Advantages

- ClO₂ is an extremely effective and powerful disinfectant agent and

oxidizer.

- ClO_2 is generated on site, thereby eliminating the need for on-site storage and/or transportation of chlorine.
- Chlorine dioxide may be prepared chemically from either sodium chlorite or sodium chlorate or generated electrochemically.
- Chlorine dioxide is relatively unaffected by pH or water chemistry.

b. Disadvantages

- ClO_2 is more expensive than hypochlorites.
- It is generally only used on large water volumes.

3. Ultraviolet Light (UV) Disinfection

Ultraviolet light is a treatment process, not something that is added to water. The system consists of passing a stream of water by specialized lights that emit wavelengths from the ultraviolet end of the radiation spectrum. When UV light passes through the water, it does not kill microorganisms, but it does prevent them from functioning normally by disrupting their DNA. Harmful microorganisms (pathogens) are rendered harmless.

UV disinfection has the secondary benefit of helping to control chloramine production through oxidation. It should not be relied on for controlling or fixing a problem with combined chlorine, but can help in maintaining a well run pool.

UV technology in pools provides additional treatment and can improve water quality, but chlorine residuals must still be maintained as per the Regulation. If a UV system is used at a pool, the chlorine must be added downstream otherwise the UV light will denature the chlorine in the same manor as UV rays from the sun eliminates chlorine from outdoor pools.

E. Summary - Biologically Safe Pool Water: Types of Disinfectants

TYPES OF CHLORINE

UNSTABILIZED

Chlorine:	Form	How Fed	pH	Effect on pool water	% available chlorine	Special notes
Gas	Gas, but is liquid under high pressure (i.e. in the cylinders)	Direct injection into main line	< 1	↓ pH	100%	Safety is key!
Lithium hypochlorite	Granular	Hypochlorinator	11	↑ pH	35%	Very soluble
Calcium hypochlorite	Granular or tablet	Mixing container, then hypochlorinator or erosion feeder	12	↑ pH ↑ hardness	65%	Very reactive
Sodium hypochlorite	Liquid	Hypochlorinator	13	↑ pH	12 – 15%	Most common; industrial strength bleach
Salt systems	Non iodized salt	Salt water goes through electrolytic cell	8	↑ pH		No chlorine handling; not practical for whirlpools

STABILIZED:

Chlorine:	Form	How Fed	pH	Effect on pool water	% available chlorine	Special notes
Dichlor	Granular or powder	Hypochlorinator	6.9	Little effect on pH	60%	Stabilized chlorine is not to be used in indoor pools or fed through any mechanical feeder. Never use stabilized chlorine to shock/superchlorinate.
Trichlor	Tablet/puck	Erosion feeder	2.9	↓ pH	90%	
Bromine (BCDMH)	Stick or tablet	Erosion feeder	6	Little effect	64% Br 32% Cl	Need to shock on a regular basis

F. Review Questions: Biologically Safe Pool Water: Types of Disinfectants

1. List three types of unstabilized chlorine.

2. What substance added to a pool is converted to chlorine in an electrolytic cell?

3. List three safety rules that must be followed when using calcium hypochlorite.

4. Under what conditions can Cyanuric acid (stabilizer) be used in a pool?

MAINTENANCE AND TROUBLESHOOTING

A. Other Chemicals

A well run pool with a properly sized filtration system, good water circulation, adequate disinfection and balanced chemicals will need little else to keep the water clean and clear. If problems such as cloudy water, staining or algae growth occur, the filtration, disinfection and water chemistry should be checked first to ensure they are adequate before using other chemicals to solve the problem. Sometimes, addition of other chemicals may be required due to the nature of the incoming water or other contaminants entering the pool.

The pool operator must follow all precautions that come with the chemicals to be used. Health and Safety Act and Regulations require that workers follow safe work procedures to protect themselves and their fellow workers. Many, if not all, of the chemicals used in the pool environment are regulated under the WHMIS and Transportation of Dangerous Goods Regulation. This serves as an additional safety measure for those workers who are handling the chemicals in the pool environment.

1. Non-Chlorine Shock

In order help reduce the problem of combined chlorine (chloramines) in pool water, a variety of non-chlorine shock treatment products are currently on the market. The active ingredient in these products is potassium peroxymonosulfate, also called permonosulfate. These products can be used on an on-going basis by the pool operator to control chloramine production, or can be used on an occasional basis to reduce high combined chlorine.

a. How it Works

- Permonosulfates destroy organic contaminants in pool water by oxidation of these compounds with oxygen, instead of chlorine.
- By controlling organic contaminants and combined chlorines, non-chlorinated shock products leave the chlorine to do its main job of destroying micro-organisms in the pool water.

b. Advantages

- Permonosulfates do not contain any chlorine or calcium, thus reducing concerns over excessive chlorine residuals or adding solids to the pool water. They do not contain cyanuric acid and have little effect on the pH of the water.
- Permonosulfates are 100% water-soluble. They are safe to store and handle

because they will not burn or produce chlorine gas.

- Permonosulfates can be added prior to swimmers entering the pool and do not require the same waiting period as chlorine shock treatments.

c. Disadvantages

- Permonosulfates will not kill off bacteria and are intended for use as an oxidizer of combined chlorine only.
- Permonosulfates will produce milky water if used excessively.
- Permonosulfates are more expensive than chlorine based oxidizing agents.
- Permonosulfates interfere with reagents used to determine disinfectant residual concentrations. See the next section for details.

d. Persulfate Interference

Non-chlorine shock products interfere with the test results when checking for combined chlorines. If such products are used, the total chlorine test reading will be inaccurate and tends to register the combined chlorine higher than it actually is. The pool operator may then believe that he needs to shock the pool due to high levels of combined chlorine when, in fact, what appears to be combined chlorine is the non-chlorine shock.

If non-chlorine shock products are to be used, a test kit that can distinguish the interference of the non-chlorine shock should be used.

2. Flocculants and Coagulants

In cases where the pool has become cloudy, a flocculent or coagulant can be used to help clear the water. These compounds combine with contaminants to form larger gelatinous clumps that are more easily trapped in the filter or precipitate to the pool bottom. Flocculants are not intended for use in diatomaceous earth filters. Please note that high rate sand filters may not be designed for use with flocculants.

Alum, also known as aluminium sulphate, is a commonly used flocculent. It is introduced as a filtering aid at the most convenient location ahead of the filter. The filter and feeder, hair and lint strainer, or skimmers are effective points of introduction.

Alum can also be used to coagulate particles in pool water by broadcasting powdered alum over the pool surface and permitting the pool to stand overnight, or for a minimum of two

hours with no use. After the floc has formed and settled to the pool bottom, vacuum the pool with a minimum of agitation to prevent the floc from becoming diffused.

Flocculent aids have been used to produce heavier or more stable flocs. These aids include colloidal silica, a bentonite clay product, and a new family of organic polyelectrolytes.

3. Algaecides

Algae are small aquatic organisms that can grow rapidly in pool water if given the chance. Sunlight, temperature, pH, chlorine residual, and the mineral content of the water affect the presence and growth rate of algae. Algae can be introduced to a pool by dirt and debris, or it may be present in the pool make up water. If not controlled, algae can spread rapidly, turning an entire pool dark green in as little as a day or two. Proper chlorination and water circulation in the pool basin should prevent algae growth.

Removing existing algae from a pool can be difficult. Algaecides and algaestats are chemicals that can be used for controlling algae in pools, but have distinctly different purposes. Algaecides kill algae when it has already become a problem. Algaestats help prevent the growth of algae.

The chemistry of algaecides is complex because there are numerous different species of algae. Some algaecides work better on one kind of algae than on others. Fresh water algae may be blue-green, red, brown or black and can cause taste, odours, turbidity, slippery spots, as well as increased chlorine demand. Algae growth is a much greater problem in outdoor pools because sunlight is necessary for the growth of algae.

If a pool basin becomes coated with algae, the pool may need to be drained and thoroughly washed down with a dilute muriatic acid or hypochlorite solution.

Algae inhibitor is a commercial product that acts as a penetrating or wetting agent to allow the chlorine to be more effective. Algae inhibitor is said to control all types of algae growth and provide a stable backup system to chlorine. It is not pH sensitive, does not evaporate, doubles activity with each 20°C rise in water temperature, concentrates on surfaces and is a powerful wetting agent.

4. Sequestering Agents

Many stains that form around main drains and inlets of pools may be the result of metals and minerals in the pool water. Such stains can often be cleaned by hand, but they can be prevented from returning. Sequestering agents, also called chelating agents, are chemical

products that increase the ability of the pool water to keep dissolved metals and mineral in solution instead of precipitating out to form stains. Pools with high iron content use sequestering agents as part of routine pool water treatment.

5. Degreasers

Degreasers are commercial acids and biodegradable detergents that effectively clean diatomaceous earth filter bags (septa) and filter sand. Each product has its own ability to degrease and rejuvenate filters. Check the manufacturer's instructions for recommended cleaning procedures for your filter.

6. Defoamers

Foam or suds are a chronic problem for most whirlpools. This may occur due to body oils, suntan lotion, detergents, shampoo or soap. A surfactant or wetting agent (defoamer) made specifically for pools may be necessary to defoam the water. Please note, use of defoamers only temporarily reduces the foam, and does not correct the underlying cause of the foam.

7. Biguanides

Biguanide sanitizer (polyhexamethylene biguanide) is not currently allowed as a sanitizer in commercial swimming pools. This sanitizer is becoming popular in the home pool/spa market. Biguanide must be used with special companion products. It is incompatible with most traditional forms of swimming pool disinfection and shocking chemicals.

B. Regulatory Requirements

The Regulation defines a manager as the person who, while on duty, is responsible for the supervision of the operation of the pool and auxiliary facilities.

The manager should:

- Have care and control of the operation of the pool
- Be available for contact by the health region and to accept orders, notices and other documents
- Be qualified to operate and maintain a pool and be trained in pool operation, water chemistry, pool filtration and maintenance.
- Make sure the pool is operated to ensure physical cleanliness, chemical balance and biological safety.

- Test for pool water quality and keep proper records of the tests
- Have written policies for the pool about safety and supervision of the public, posting of rules, education of swimmers, response to water quality issues, a general sanitation plan, and other items as required by the health region

1. Permits

Swimming pools must be approved by the health authority. This includes all pools with the exception of those constructed for the use of a single family dwelling and used only by the owners and their guests, and not operated as a business. A permit is issued to the owner. Pools are not allowed to operate without a permit.

It should be noted that all pools must conform to the Building Code. Although the Building Code is enforced through a separate government agency, the applications require many of the same pieces of information. The pool must meet the building code to proceed with the Health permits.

2. Changes or Modifications to the Pool

The health region must be notified in writing if there is a change in ownership or responsible person.

Before making any significant changes to the operating procedures of the pool, the responsible person must apply to the health region for written approval. This does not include routine and ongoing maintenance.

Before conducting renovations or alterations to the pool that will affect the hydraulic system, disinfection system, filtration system, or the pool basin the responsible person must apply to the health region for written approval.

Some of these changes can be quite substantial so an engineer's report may be required.

3. Recordkeeping

Records are required to be kept in a written form.

Pool records need to include information on:

- a. quantities and dates of all chemicals used
- b. time and results of all pH tests
- c. time and results of all free chlorine residual tests

- d. time and results of all combined chlorine residual tests
- e. results of all microbiological tests
- f. temperature of the water at least once every 24 hours
- g. any other tests conducted

Tracking of this information may assist the operator in identifying the source of a problem.

The local health region will provide a copy of the test results of pool bacteriological samples to the responsible person for self-monitoring purposes.

Fecal accidents must be recorded in a log book. The date and time of the event, type of incident, concentration of free available chlorine and the ORP at the time, pH, the procedures followed and the person conducting the procedures all need to be noted in the log book. A liquid fecal material release into a pool needs to be reported to the regional health authority within 24 hours.

4. Written Policies

Written policies should be drawn up for every pool. The responsible person for each facility should have policies on:

- Safety and Supervision,
- Signs for Public Safety,
- Public Education,
- Water Quality Issues,
- General Sanitation Plan.

These policies will help guide the operator in keeping a safe and healthy environment for pool patrons. Information required in each policy is outlined below.

a. Safety and Supervision Policy

Each pool should have a safety and supervision plan that includes information on:

- lifesaving equipment to be provided
- location and availability of a phone for emergency use
- first aid kit and location
- bather to lifeguard ratios or recommendations for bather safety during special events at a pool that does not usually provide lifeguards
- chemical storage in compliance with the Fire Code

In addition to the Ministry of Health legislation that must be followed by pool operators, other public agencies have legislation that applies in a pool setting. As mentioned in the last point above, chemicals must be stored in accordance to the Fire Code. Workplace Health and Safety has legislation covering worker safety, including Workplace Hazardous Materials Information System (WHMIS). Information on chemical product safety, storage and responses in case of mishaps must be maintained on site. Legislation covering the transportation of dangerous goods must also be followed.

b. Notices for Public Safety

The following information is required on signs and markings around the pool area. They should be sized and located to be easily seen by all pool users. The notices must include:

- requirement to take a cleansing shower prior to entering .
- statements about no glass allowed on deck or in barefoot areas.
- the depth of the pool and whether diving is allowed.
- no swimming if intoxicated.
- the temperature range of the whirlpool, steam room and sauna.
- advice on consulting a physician if on medication for high blood pressure, heart conditions, or other medical conditions prior to use of a whirlpool or sauna.
- bather load and why it is limited.
- a restriction on pets in the pool area (animals used to assist persons with disabilities are allowed).
- removal of street shoes in wet areas.

The notices can also include any other information that will assist the responsible person in maintaining the health and safety of the pool facility users.

For those facilities where lifeguards are not provided, signs must indicate the following information:

- **Do not swim alone.**
- **Children up to 14 years must be supervised.**
- **No lifeguard on duty.**

c. Public Education

The responsible person is required to develop and implement an education plan for the pool users that is appropriate to the type of pool facility. The pool patrons must

be informed of the following issues to help maintain their own health and safety as well as that of other pool users:

- Bathers must stay out of the pool if they have diarrhea, or a history of diarrhea over the previous two weeks,
- Use of protective, water-resistant swimwear to prevent contamination is required if the bather is under 35 months old or is incontinent,
- Time limitations of ten minutes are recommended in the whirlpool, sauna or steam room, and
- Bathers with certain conditions should consult a physician prior to use of a whirlpool, sauna, or steam room. Such bathers include those who are pregnant, have heart disease, hypertension, seizures, diabetes and obesity or are over the age of 65 years. Children under 2 years of age should be closely monitored by their guardian if they are allowed to use a whirlpool, sauna or steam room as their body temperatures can rise rapidly in heated environments.

d. Water Quality Issues Response Plan

The responsible person must develop a response plan that outlines the steps to be taken when any of the following scenarios occur:

- Standards for the ORP, free chlorine, combined chlorine, cyanuric acid, pH and turbidity are not being met
- Blood, food or chemicals foul the pool
- Fecal matter or vomitus foul the pool

The plan for water quality issues needs to identify who is responsible to take action if any of the above situations occur. The plan must also include emergency contact numbers. Since people and information change regularly, it is critical that this information be updated as often as changes occur. Emergency contact information should be reviewed at least on a monthly basis. In the event of an emergency it is important to have correct and up-to-date information.

It is important to have a fecal contamination management plan for your pool. There is a difference in how you deal with formed stool versus liquid stool or vomitus.

The difference is in how much bacteriological contamination can be spread by each form and what it will take to inactivate the disease-causing organisms or pathogens

that may be present. Response plans for each situation are outlined in the appendices. If the pool is a low-volume pool, such as a whirlpool, teach pool or wading pool, the pool must be drained and the pool basin cleaned and disinfected.

Records of all fecal accidents in a pool must be kept that describe the date, time and type of incident, the free chlorine, ORP and pH readings, and the procedures followed by the person dealing with the situation. Any liquid fecal material released into a pool must be reported to the local health region within 24 hours of its occurrence.

A sample faecal response plan is in Appendix A.

e. General Sanitation Plan

The responsible person must develop and implement a plan which outlines a routine schedule for cleaning and disinfection of:

- pool decks,
- washrooms and change rooms,
- showers,
- steam rooms and saunas, and
- any other equipment in contact with users of the facility (e.g. common gym equipment)

5. Pool Maintenance

The floors and decks used by bare foot patrons must be impervious to moisture, easy to clean, and easy to maintain. Cleaning products used on the pool deck should not be ammonia based. Such chemicals could adversely affect pool water chemistry if they are splashed into the pool.

Other surfaces such as benches and washroom fixtures that patrons may come into contact with must also be maintained in a clean and sanitary manner to prevent the spread of disease.

The pool basin and liner must be kept in good repair. Loss of water due to cracked basins can be a big cost for your pool operation. Pool basin surfaces in disrepair may also allow for the growth of algae in the area.

In general, the entire pool premises must be kept in a condition that allows for the safe and sanitary operation of the pool. All parts of the pool must be operated so that contamination of the pool water is limited and the patrons are safe. For a sample maintenance checklist, see **Appendix F.**

Appendix G has been included at the end of this manual to assist the pool operator in troubleshooting some water quality and maintenance problems that may occur in swimming pools.

6. Rental Hot Tubs

If a hot tub is a mobile rental unit, the owner must prepare an operating manual describing the proper disinfection, operation and maintenance of the hot tub. The manual must be supplied to anyone who rents the hot tub unit. It is required that an executive officer of the local health region approves the operation of the mobile rental hot tub if it is to be used in a public place.

C. Whirlpools

High temperature pools are known by various names such as whirlpools, hot tubs and spas. Due to their hotter temperatures, smaller volumes, high bather loads and fast flow rates, such pools are often more difficult to maintain than other pools and pose extra safety concerns. The operator must be aware of certain conditions that are unique to whirlpools in order to keep the water clean and safe for the bathers.

One consideration for high temperature pools is that *Pseudomonas aeruginosa* bacteria thrive in water above 30 Celsius. These bacteria can cause skin, ear and other types of infections. They can also produce a protective slime layer, or biofilm, that makes it more difficult to destroy with regular disinfection. For more information on *Pseudomonas aeruginosa* in whirlpool water, see **Appendix D**.

Picture: Whirlpool



1. Whirlpools Bather Load: The Significance

It has been said four (4) people in a 600 gallon spa are equivalent to 200 people in a 40,000 gallon swimming pools. It seems a little excessive when heard, but the loading of perspiration alone becomes significant.

A single bather in a spa pool at 40°C (104°F) is estimated to lose up to 3 pints of perspiration per hour. With each pint of perspiration there are approximately 2000 parts per million of inorganic and organic nitrogen compounds which rapidly combine with the chlorine in a pool.

To illustrate the difference between a swimming pool and spa pool, first consider a 40 000 gallon pool compared to a 600 gallon spa pool. Assuming there is 2 ppm of chlorine in the pool, this is equal to approximately 2/3 lb. of chlorine. If 40 people jump in and use it for an hour, they can easily use up 0.5 ppm of chlorine from the perspiration they generate alone. This would reduce the chlorine to 1.5 ppm.

A 600 gallon spa with 5 ppm of chlorine has only 0.4 ounces of chlorine. If four bathers come into the spa for one hour, they can add 12 pints of perspiration. This alone can consume 0.4 ounces of chlorine, using up all of the chlorine in one hour.

So in our example above, even though there is a higher concentration of chlorine in the spa to begin with, the heavy bather loads can readily use it up. If a spa pool has disinfection

interrupted for even a few hours, bacteria are able to multiply quickly (once every 20 minutes) and the pool may have millions of organisms in a relatively short period of time.

2. **Emergency Shut-off**

Due to the high velocity of the water being recirculated in whirlpools, there is the potential for injury from hair being sucked into skimmers or drains. Incidents have occurred where children have been trapped underwater by the suction caused by the main drain at the bottom of a spa. An emergency shut-off device will help prevent potential injuries and deaths. A whirlpool should have a well marked switch close to the whirlpool that, when pressed, will shut off all pump systems, including the main pump and jets. Once the pumps are shut off, the suction stops and the individual can be freed. This can be connected to an audible alarm system that will alert others that help is needed.

3. **Clock**

A clock is required to be visible to patrons to allow them to monitor their time in whirlpools and saunas. Time exposed to elevated temperatures should be limited to 10 minutes. Since the time spent in the hot tub or sauna is typically a self-monitored event, a clock must be available.

4. **Thermostat Control**

Whirlpools must be fitted with temperature regulators. Situations have occurred where heater thermostat controls have not worked properly causing whirlpool temperatures to become dangerously hot. In one such case, a young football player jumped into a spa pool where the heat control-limiting switch failed. The temperature of the spa pool was 60 degrees Celsius (140°F). The individual was hospitalized with serious 2nd and 3rd degree burns. There have been many instances of similar situations reported. **For safety reasons a whirlpool must not operate at greater than 40 degrees Celsius (104 F) while in use.**

A thermostatic control equipped with an automatic safety shutoff should be installed in all high temperature pools to prevent the water from climbing above the maximum allowed. The water temperature should also be manually checked on a routine basis. If temperatures seem to be drifting higher, it may be time to repair the equipment.

D. Safety Equipment

Certain safety equipment must be provided at a permitted pool facility. In emergency situations, the patrons must be able to easily access lifesaving equipment and be able to contact emergency personnel.

1. Emergency phone

An emergency phone must be available for use by pool patrons. It is vital that you have an emergency phone easily available near the pool so that emergency responders can be called quickly when necessary. Make sure the location of the phone is clearly posted. The phone should be within one minute of the pool and needs to be available at all times the pool is open. It is a good idea to have the phone available even when the pool is closed. Make sure that emergency phone numbers are posted by the phone.

Picture: Poolside Emergency Phone



2. Lifesaving Equipment

Lifesaving equipment needs to be in good condition and readily available if a rescue is necessary. Reaching aids allow a person on the deck to rescue someone in trouble in the water without the risk of entering the water themselves.

Picture: Lifesaving Equipment



If your pool has a lifeguard, you will also need a backboard for spinal injuries. This piece of equipment must only be used by someone trained to handle spine and neck injuries.

3. First Aid Kit

A first aid kit should be made available at your pool. No matter how careful pool operators are, unintentional injuries can and do happen around pools. The facility staff should have first aid training. Keep your first aid kit fully stocked. Because of the hazards of blood-borne pathogens (Hepatitis B, HIV/AIDS), it is important that you also have gloves, CPR masks, and goggles or a face shield.

4. Shower Temperature Control

A shower must be equipped with a thermostatic mixing valve capable of providing water to each shower head with a temperature of 35 to 40 degrees Celsius. Higher temperatures could cause scalding and lower temperatures are uncomfortable for most bathers. If the shower water is not hot enough, pool patrons are less likely to shower as required prior to entering the pool.

E. Summary - Pool Maintenance and Regulatory Requirements

Other chemicals can be used to help keep pool water clean and clear. However, before they are used, the pool's circulation, filtration, and disinfection systems should all be checked to ensure they are functioning properly. Whatever chemicals are used, the manufacturer's directions and precautions must always be followed.

Responsible persons for a permitted pool should have written policies covering safety, water quality and sanitation of the pool.

Whirlpools and other warm water pools have certain maintenance problems due to their high bather loads relative to their water volume. The higher temperatures of such pools also pose a health risk to bathers.

F. Review Questions: Pool Maintenance and Regulatory Requirements

1. Will test results for combined chlorine be accurate if a non-chlorinated shock chemical is used?

2. A permitted pool must have written policies covering what subjects?

3. Name three safety features required for whirlpools.

GLOSSARY OF TERMS

Acid:	A solution that contains more H ⁺ ions than OH ⁻ ions and has a pH of less than 7.
Algae:	Chlorophyll-containing plants ranging from one-celled to multi-celled.
Algaecide:	An agent capable of killing algae.
Backwash:	The process of cleaning a filter where the water flow is reversed and sent to waste.
Bacteria:	Microscopic one-celled living organisms.
Bactericide:	An agent capable of killing bacteria.
Base:	A solution that contains more OH ⁻ ions than H ⁺ ions and has a pH greater than 7.
Calcification:	To become hardened by calcium carbonate.
Chloramines:	Chlorine combined with ammonia containing contaminants (also known as combined chlorine).
Coliforms:	Bacteria found in the intestines of animals and humans. Their presence in water indicates the possible presence of pathogens.
Combined Chlorine:	See chloramines.
Corrode:	To eat away gradually by chemical action.
Cyanuric Acid:	A chemical stabilizer that combines with chlorine in pool water to prevent the loss of chlorine due to direct sunlight.
Diatomaceous Earth	Fossil remains of tiny aquatic plants called diatoms that are used as a type of filter media.
Disinfection:	Destruction of pathogenic microorganisms and reduction of non-pathogenic microorganisms by thermal or chemical procedures.
Effluent:	The water that flows out of the filter.
Flocculent:	Alum or similar substances added to water that combine with contaminants making them easier to filter out.
FAC:	(or Free Available Chlorine) Chlorine disinfectant in pool water that is available to react with new contaminants introduced to the water.
Hardness:	Calcium, magnesium and other dissolved minerals which may cause scale build-up.
HPC:	Heterotrophic Plate Count. A general bacteria count in a water sample.

Indicator:	A weak acid or base whose colour depends on the pH of the solution because it's acid and base forms has different colours.
Influent:	The water that flows into the filter.
O.R.P.:	Oxidation reduction potential is the electrical potential generated by an oxidising or reducing chemical in solution. A value of 650 millivolts or more on an O.R.P. sensor indicates pool water has good bacteriological disinfection.
Particulates:	Dirt and other larger dissolved substances in pool water.
Pathogen:	Disease producing micro-organism.
pH:	The concentration of H ⁺ ions in a solution measured on a scale from 0-14. The acidity of a solution.
Reagent:	A chemical substance that, because of the reaction it causes, is used in chemical analysis and synthesis.
Scale:	A hard or brittle coating or crust usually caused by calcium carbonate.
Shock:	Raising the chlorine level to 7 to 10 times the combined chlorine level to burn off chloramines and to practice algae control.
Slurry:	A suspension of a solid in a liquid.
Superchlorinate:	Raising the free chlorine residual to 25 mg/L or higher for short periods of time to achieve greater disinfection.
Total Chlorine:	A combination of free available chlorine and combined chlorine residuals.
Turbid:	Unclear or murky water due to sediment or suspended particulate matter.
Turnover:	The total volume of pool water circulated once through the recirculation system.

APPENDIX A - DEFECATION CONTROL STRATEGIES FOR SWIMMING POOLS

Environmental Health recommends the following defecation control strategies for swimming pools.

1. Increase user/parent awareness not to use the pool when they or their children have diarrhea. Possible methods of distributing this information are on handouts and information to users, swim registrations, signs in the washrooms, etc.
2. Babies and very small children who do not have control of their bowels should wear appropriate clothing to prevent faecal contamination of the pool (i.e. pool pants, tight bathing suit with rubber pants over them, or training pants and rubber pants over them).
3. If a **faecal accident** does occur, the staff should enlist the following protocol:

The owner of a swimming pool that is contaminated with vomit or solid faecal matter, or whirlpool contaminated with vomit must perform the following procedure:

- i. Close the affected area. (A whirlpool would require full closure.)
- ii. Physically remove as much material as possible with a leaf skimmer or other similar type scoop. Dispose of material into a toilet. Sanitize the skimmer or scoop with a solution of 100 ppm chlorine for two minutes.
- iii. Treat the immediate area of the swimming pool water and surfaces with a concentration of chlorine that will yield a CT of 200.
- iv. Balance water
- v. Submit water sample to provincial laboratory for bacteriological analysis.
- vi. Reopen area.

The owner of a swimming pool that is contaminated with diarrhea or a whirlpool that is contaminated with fecal matter must perform the following procedure:

- i. Close the swimming pool and instruct all bathers to exit the pool.
 - ii. Physically remove as much material as possible. If a vacuum is used, direct waste to the sanitary sewer.
 - iii. Treat the entire volume of swimming pool water with a concentration of chlorine that will yield a CT of 15300 or another scientifically proven method capable of completely destroying cryptosporidium cysts throughout the whole circulation system. Ensure that the pH is maintained at about 7.0.
 - iv. Backwash.
 - v. Balance water
 - vii. Submit water sample to provincial laboratory for bacteriological analysis.
 - vi. Reopen pool.
4. Record faecal accidents in the pool records, including time, location and action taken. If it was a diarrheal incident, contact the local health authority.

APPENDIX B - INSTRUCTIONS FOR SAMPLING POOL WATER FOR BACTERIA

Proper Sampling Technique

1. Wash your hands with soap and warm water.
2. Use sample bottle for “Water Bacteriology” supplied by the Health Region.
3. Fill out the identification label on the bottle when the bottle is dry. **Samples that are missing the information on the label may not be processed.**
4. Remove the cap from the bottle. **Do not touch the mouth of the bottle, inside of the cap, or place the cap down on a surface.**
5. Choose a sampling location near a skimmer, if applicable, or anywhere in a pool with a gutter system.
6. Plunge the bottle upright into the pool until your arm is almost fully submerged. Be sure not to spill the chemical powder/pill from the bottle. Be careful to always move the mouth of the bottle forward, so that water passing over your hand will not contaminate the sample. Move the bottle slowly, until it is filled to between the fill line marked on the bottle and the top of the bottle. **Do not overfill the bottle; if this occurs, begin again with a new bottle.**
7. Replace the cap immediately.
8. Complete the requisition form, including the following information:
 - Submitter or sampling person name and address
 - Address, City, Postal Code and Telephone number
 - Date & Time of Collection, AM/PM and Phone number
 - System Name *i.e. Pool Name*
 - Site Name *i.e. main pool*
 - Water information *i.e. free chlorine residual and pH*

The Provincial Lab (BCCDC) may not test water if any of the above information is missing.

9. Place the bottle and completed form in plastic bag. Ensure the cap is on tight.
10. Keep water sample refrigerated in a cooler, or place on ice, and deliver to the Health Region as soon as possible (location and times listed below). *Samples must arrive at the lab not later than 24 hours after collection.*

Notification of Results

When an unsatisfactory result is received, a Public Health Inspector will attempt to contact the person listed on the requisition form to discuss the result.

APPENDIX C (1) - TABLES FOR ADJUSTING TOTAL ALKALINITY

Decreasing Total Alkalinity - Adding Muriatic Acid

Metric Measure Table Litres of Pool Water

Required Decrease in ppm	2000 L	20 000 L	40 000 L	80 000 L	200 000 L	400 000 L
10 ppm	32.5 mL	325.0 mL	650.0 mL	1.30 L	3.25 L	6.50 L
20 ppm	65.0 mL	650.0 mL	1.30 L	2.60 L	6.50 L	13.0 L
30 ppm	97.5 mL	975.0 mL	1.95 L	3.90 L	9.75 L	19.5 L
40 ppm	130.0 mL	1.30 L	2.60 L	5.20 L	13.0 L	16.0 L
50 ppm	163.0 mL	1.63 L	3.26 L	6.52 L	16.3 L	32.5 L
60 ppm	195.0 mL	1.95 L	3.90 L	7.80 L	19.5 L	39.0 L
70 ppm	228.0 mL	2.28 L	4.56 L	9.12 L	22.8 L	45.5 L
80 ppm	260.0 mL	2.60 L	5.20 L	10.4 L	26.0 L	52.0 L
90 ppm	293.0 mL	2.93 L	5.88 L	11.7 L	29.3 L	58.5 L
100 ppm	325.0 mL	3.25 L	6.50 L	13.0 L	32.5 L	65.01 L

English Measure Table Imperial Gallons Of Water

Required Decrease in ppm	500 gal.	5000 gal.	10000 gal.	20000 gal.	50000 gal.	100000 gal
10 ppm	1.25 oz.	12.5 oz.	17.3 oz.	1.56 oz.	3.92 oz.	2.35 gal.
20 ppm	2.5 oz.	0.25 qts.	0.47 qts.	3.12 qts	2.35 gal.	4.70 gal.
30 ppm	3.75 oz.	0.36 qts.	0.70 qts.	4.68 qts.	3.53 gal.	7.06 gal.
40 ppm	5.0 oz.	0.47 qts.	0.90 qts.	1.88 gal.	4.70 gal.	9.40 gal.
50 ppm	6.25 oz.	0.59 qts.	1.17 qts.	2.35 gal.	5.89 gal.	11.76 gal.
60 ppm	7.5 oz.	0.71 qts.	1.40 qts.	2.82 gal.	7.06 gal.	14.11 gal.
70 ppm	8.75 oz.	0.82 qts.	1.65 gal.	3.30 gal.	8.25 gal.	16.49 gal.
80 ppm	10.0 oz.	0.94 qts.	1.88 gal.	3.76 gal.	9.40 gal.	18.80 gal.
90 ppm	11.25 oz.	1.06 qts.	2.11 gal.	4.22 gal.	10.56 gal.	21.12 gal.
100 ppm	12.5 oz.	1.18 qts.	2.36 gal.	4.72 gal.	11.79 gal.	23.58 gal.

APPENDIX C (2) - TABLES FOR ADJUSTING TOTAL ALKALINITY

Increasing Total Alkalinity - Adding Sodium Bicarbonate (Baking Soda)

Metric Measure Table - Litres of Pool Water

Required Increase in ppm	2000 L	20 000 L	40 000 L	80 000 L	200 000 L	400 000 L
10 ppm	36.0 g	360.0 g	720.0 g	1.44 kg	3.60 kg	7.19 kg
20 ppm	72.0 g	720.0 g	1.44 kg	2.88 kg	7.20 kg	14.4 kg
30 ppm	108.0 g	1.08 g	2.16 kg	4.32 kg	10.8 kg	21.6 kg
40 ppm	144.0 g	1.44 kg	2.88 kg	5.76 kg	14.4 kg	28.8 kg
50 ppm	180.0 g	1.80 kg	3.59 kg	7.18 kg	18.0 kg	35.9 kg
60 ppm	216.0 g	2.16 kg	4.31 kg	8.62 kg	21.6 kg	43.1 kg
70 ppm	252.0 g	2.52 kg	5.03 kg	10.1 kg	25.2 kg	50.3 kg
80 ppm	288.0 g	2.88 kg	5.75 kg	11.5 kg	28.8 kg	57.5 kg
90 ppm	324.0 g	3.24 kg	6.47 kg	12.9 kg	32.4 kg	64.7 kg
100 ppm	360.0 g	3.60 kg	7.19 kg	14.4 kg	36.0 kg	71.9 kg

English Measure Table - Imperial Gallons of Pool Water

Required Increase in ppm	500 gal.	5000 gal.	10000 gal.	20000 gal.	50000 gal.	100000 gal
10 ppm	1.44 oz.	0.9 lbs.	1.8 lbs.	3.6 lbs.	9.0 lbs.	18.0 lbs.
20 ppm	2.88 oz.	1.8 lbs.	3.6 lbs.	7.2 lbs.	18.0 lbs.	36.0 lbs.
30 ppm	4.32 oz.	2.7 lbs.	5.4 lbs.	10.8 lbs.	27.0 lbs.	54.0 lbs.
40 ppm	5.76 oz.	3.6 lbs.	7.2 lbs.	14.4 lbs.	36.0 lbs.	72.0 lbs.
50 ppm	7.20 oz.	4.5 lbs.	9.0 lbs.	18.0 lbs.	45.0 lbs.	90.0 lbs.
60 ppm	8.64 oz.	5.4 lbs.	10.8 lbs.	21.6 lbs.	54.0 lbs.	108.0 lbs.
70 ppm	10.08 oz.	6.3 lbs.	12.6 lbs.	25.2 lbs.	63.0 lbs.	126.0 lbs.
80 ppm	11.52 oz.	7.2 lbs.	14.4 lbs.	28.8 lbs.	72.0 lbs.	144.0 lbs.
90 ppm	12.96 oz.	8.1 lbs.	16.2 lbs.	32.4 lbs.	81.0 lbs.	162.0 lbs.
100 ppm	14.40 oz.	9.0 lbs.	18.0 lbs.	36.0 lbs.	90.0 lbs.	180.0 lbs.

APPENDIX D - PSEUDOMONAS AERUGINOSA INFORMATION SHEET

Pseudomonas aeruginosa in whirlpool water is of public health concern because it can cause skin rashes and ear infections. The water conditions in whirlpools are ideal for these bacteria to survive. The turbulent water and relatively heavy bather load makes maintaining adequate disinfection more difficult. *Pseudomonas* can even survive chemical treatment that kills off most other bacteria. The warm water opens up pores of the skin and permits bacterial invasion.

Preventive Measures

1. Exclude persons having obvious or known infections.
2. Require patrons to take a shower using warm water and soap before entering the pool. (*Pseudomonas* can be present on the skin).
3. Quickly remove all waste which may enter the pool.
 - Ensure that the filtration system is operating properly.
 - Frequent filtering of the water is very important. A whirlpool greater than 4 m³ in volume requires a minimum of three (3) complete water turnovers every hour. A whirlpool less than 4 m³ in volume requires a minimum of four (4) turnovers every hour.
 - Degrease the filter every few months to prevent it from harbouring resistant strains of *pseudomonas*.
 - Remove the scum line at least once a day (or more frequently if necessary).
 - Body oils can build up fast, leaving a layer of fat that will adhere to the whirlpool; bacteria can then grow underneath that layer.
 - Change the water frequently.
 - Unoxidized materials in the pool can accumulate and reduce the effectiveness of your chlorine disinfectant.
4. Destroy disease-producing organism by maintaining a proper disinfectant residual and pH. For best results in a whirlpool:
 - Free chlorine residual should be at least 2 - 3 ppm.
 - pH level must be between 6.8 and 7.6, optimum 7.2
5. Submit water samples to the Provincial Laboratory of Public Health at least once a week.

Appendix D Continued

Pseudomonas Isolation in Water Sample

When *Pseudomonas aeruginosa* is identified in a whirlpool water sample, the whirlpool must be closed (i.e. free of all bathers) until the following procedure is completed:

1. Backwash.
2. Increase Free Available Chlorine (FAC) level to 20-50 ppm (with non-stabilised chlorine).
3. Run the water through the circulation system for at least 4 - 6 hours.
4. Completely drain the whirlpool.
5. Scrub the whirlpool pool walls with acid or sanitizer.
6. Rinse off acid/sanitizer.
7. Refill the pool.
8. Adjust water chemistry to regular operating parameters.
9. Take a water sample and send it to the lab.
10. Reopen to the public.

If consecutive samples show the presence of *Pseudomonas aeruginosa*, the whirlpool must remain closed until a local health inspector has inspected the pool and a satisfactory sample has been determined by the Provincial Lab.

Removing Resistant Strains

1. Super-chlorinate to 50 ppm, maintain proper pH, and leave re-circulation system on overnight.
2. Drain and follow previous procedure.

APPENDIX E - TOTAL ALKALINITY ADJUSTMENT REQUIRED

For Cyanuric Acid Levels

pH	CYANURIC ACID FACTOR (CAF)
8.5	0.38
8.0	0.36
7.5	0.30
7.0	0.21
6.5	0.10

- STEP 1. Multiply the measured CYA level by the appropriate correction factor.
- STEP 2. Subtract the results in Step 1 from the measured total alkalinity.
- STEP 3. The result from Step 2 is the adjusted total alkalinity to be used for water balance calculations

APPENDIX F - MAINTENANCE CHECKLIST

Checklist for Pool Operators

Daily

Prior to opening the pool for the day, check the following items. Do any necessary work or make appropriate adjustments. Keep a record of all test results and of any maintenance conducted.

Check pool water for:

- water clarity
- algae growth and debris on the pool bottom
- free chlorine
- pH
- water temperature
- water level
- skimmer basket cleanliness (if pool has skimmers).

Check recirculation equipment for:

- pump operating and flow rate adequate
- filter pressure gauges at acceptable levels
- chemical feeders operating and set at correct rates
- chemical storage levels adequate for the day.

Check pool enclosure for:

- pool deck, change rooms, showers, toilets and sinks cleaned and disinfected
- toilets, sinks and showers operating properly
- soap at showers and hand sinks
- air temperature comfortable.

Weekly

Test pool water for combined chlorine.

Take and submit pool water sample to the Provincial Lab.

Check structural and safety condition of pool deck and deck equipment.

Check first aid supplies.

Check chemical supplies.

Check test kit reagent supplies.

APPENDIX G - TROUBLESHOOTING

The following information is included to assist a pool operator in identifying problems that can occur in pools. A specific problem is identified in the section heading, with possible causes on the left-hand box and possible solutions on the right-hand box.

Green Water

1. May be due to dissolved iron.	Superchlorination will convert dissolved iron to a red-brown precipitate which can be vacuumed and filtered from the pool.
2. Improper use of bromine or iodine.	
3. Use of anthracite filters.	

Cloudy Green Water

This is usually due to algae growth.	Immediate superchlorination and maintaining proper free chlorine residual may solve the problem. If regrowth continues to occur, the filter media may be saturated with algae and must be replaced.
--------------------------------------	---

Dark and/or Slippery Spots on the Pool Side Walls or Deck

This is usually due to algae growth.	Sprinkle a few granules of calcium hypochlorite directly on the spots. This may cause white spots on a painted or coloured liner bottom.
--------------------------------------	--

Milky Cloudiness

In pools using diatomite filters, it is usually due to diatomaceous earth in the pool. Faulty pre-coat procedures or broken or torn elements are the usual cause.	Check and/or repair filter elements. Check and adjust pre-coat procedures.
In other pools, milky cloudiness is usually due to excess dirt load or to precipitation of calcium compounds.	Cloudiness should disappear with adequate chlorination and efficient filtration. Superchlorination will help if the cloudiness is due to organic dirt.
Very high total alkalinity.	Slug acid to lower total alkalinity.

Eye Irritation

Usually due to improper pH control or a build-up of combined chlorine compounds in the water due to insufficient chlorination.	Adjust the pH to between 6.8 - 7.8. If the combined chlorine concentration is more than 1 ppm, shocking is required.
--	--

Appendix G: Troubleshooting continued

Green Hair

Caused by copper ions in the water.	Discontinue use of copper based algaecides and maintain proper pH to prevent corrosion of copper pipes in the system.
-------------------------------------	---

Low Chlorine Residual

Chlorine feed rate is too low.	Boost rate of feed.
Chlorine demand above normal due to heavy swimming load, hot sunny weather, algae, debris in pool such as leaves, etc.	If chlorinator capacity is not sufficient, temporarily supplement chlorine feed by hand dosage of hypochlorites. If this is a constant problem, increase chlorinator capacity.
Corrosion or plugging of chlorine injector assembly.	Clean chlorine feed system.

Turbidity

Low recirculation rates.	Check flow meter, then the pumps and filters - backwash more often if filters are plugging.
Poor filtration.	If D.E. is used, slurry feeder may not be working properly, there may be a tear in the D.E. filter cloth, or too little pre-coat. If a sand filter is used there may be channelling in sand filter.
Underfeeding of alum flocc (if used).	Increase feed.
Algae growths.	Superchlorinate. Use copper sulphate. Keep high free chlorine residual.
Air leaks (fine bubbles in water)	Check piping.
Wind-blown dust (dusty road nearby)	More vacuuming. Cover pool when closed. Increase turnover rate of pool.
Precipitation of hardness due to addition of soda ash.	No remedy. Keep circulating. Control pH below 6.8.
Iron in suspension.	<ol style="list-style-type: none"> 1. Add make-up water through filter. 2. Flush supply and make-up lines occasionally. 3. Add aluminium sulphate flocculent to entire pool surface at rate of 30 g per 10 sq m of pool surface, and let settle. (Do not use aluminium sulphate with high rate filters). 4. Superchlorinate.
Diatomaceous earth getting into pool.	Tear in filter cloth or broken element. Not enough recycle time in pre-coat. D.E. too fine for filter cloth.

Appendix G: Troubleshooting continued

Algae Growths

Low chlorine residual.	Raise feed rate, supplement with hypochlorite.
Hot sunny weather.	Maintain high chlorine residual. Add an algaecide if necessary.
Pool temperature too high.	Keep below 26.7° Celsius.
Poor recirculation (dead spots in pool).	Check recirculation rates. Clean corners and behind ladders with hypochlorite solution.
Wet spots on deck.	Eliminate, if possible, hand hose with hypochlorite and keep dry.

Short Filter Run (D.E. Filter)

1. Algae growth.	Immediate superchlorination and maintaining proper free chlorine residual may solve the problem.
2. Poor pre-coat.	Use correct dosage and recycle during precoat. Replace filter cloth if plugged.
3. No slurry feed.	Unplug or install slurry feed.
4. Suntan and hair oils in pool water.	Require patrons to shower before entering pool.
5. D.E. too fine.	Check recommended size.
6. Pre-feeding soda ash.	May cause bulky non-porous filter coating of not added slowly in dissolved form.
7. Filter cloth or element clogged.	May require dismantling and acidizing elements.
8. High turbidity.	Vacuum pool in morning. Check total alkalinity.

Short Filter Run (Sand Filter)

Backwash rate too low or poor distribution of backwash water.	Check rate.
Too high alum dosage.	Check and adjust feeders.
Mud ball formation or growths in filter.	Chlorine residual too low.
Other problems as in D.E. filters, items 1, 4, 6 and 8 (above).	Remedies as in D.E. filters items 1, 4, 6 and 8 (above).

Appendix G: Troubleshooting continued

Low pH

Soda ash feeder plugged. Insufficient soda ash used. Abnormally high chlorine dosage.	Increase soda ash feed. Check amount added per day as well as feed rate.
---	--

High pH

High pH in make-up water.	Add muriatic acid (take care in handling).
---------------------------	--

Clogging of Hypo Chlorinator

Residue or precipitate clogging feed pump suction (particularly with hard water).	Syphon off and feed only clear liquid, using two containers. Add a few spoonfuls of calgon to the mixing tank.
Lines clog.	Clean or flush regularly.

Chlorine Residual Too High

Chlorine demand has dropped resulting in excess feed rate.	Turn down chlorinator.
--	------------------------

Odours

Combined chlorine residual too high.	Shock the pool. Maintain combined chlorine under 1 ppm.
--------------------------------------	---

Scale Build-Up

pH too high.	Obtain expert advice.
Hardness of water.	
High total alkalinity.	

Corrosion Problems

pH too low.	Add soda ash, maintain pH level of 6.8 - 7.8.
Hardness too low.	Add calcium chloride dihydrate.

Pump Failure

Air lock, air entering suction side of pump.	Prime pump, check pool water level for possible air entering skimmers, check hair and lint strainer for air leak.
Plugged hair and lint strainer.	Clean hair and lint strainer.
High resistance to water flow.	Backwash filter. Check hair and lint strainer, check for closed valves.

Appendix G: Troubleshooting continued

White Ring around the Water Level Tile

Calcium salts in hard water, high pH.	Lower pH with sodium bisulphate or muriatic acid. Maintain pH level of 6.8 - 7.8.
---------------------------------------	---

Athlete's Foot

Fungus on pool decks, change room and shower floors.	Exclude people with athlete's foot from pool, disinfect. Proper foot care by swimmers is necessary, i.e. drying of feet properly with special attention between toes.
--	---

Scum on Pool Walls at Water Level

Inadequate skimming.	Check float weir, increase flow through skimmers. Scrub pool walls.
Body oils and cosmetic lotions used by swimmers.	Shower with soap and warm water before entering pool. Recommend bathing caps be worn. Scrub pool walls.

Sand in Pool

Failure of filter under drain system (collection manifolds).	Remove filter sand, check and replace under drains as necessary.
--	--

APPENDIX H - CONVERSION FACTORS

Length	Multiply by
inch to cm	2.5400
foot to cm	30.4800
foot to metre	0.3048
yard to metre	0.9144
cm to inch	0.394
cm to foot	0.033
metre to foot	3.281
metre to yard	1.094

Area	Multiply by
square inch to square cm	6.451
square foot to square metre	0.093
square yard to square metre	0.836
square cm to square inch	0.155
square metre to square foot	10.764
square metre to square yard	1.196

Volume to Volume	Multiply by
cubic foot to cubic metre	0.028
cubic yard to cubic metre	0.765
cubic metre to cubic foot	35.314
cubic metre to cubic yard	1.308
litre to gallon (Cdn)	0.219
litre to gallon (US)	0.264

cubic metre	=	1000.0 Litres
cubic metre	=	264.2 U.S. gallons
cubic metre	=	220.0 Imperial gallons
cubic foot	=	28.32 Litres
cubic foot	=	7.481 U.S. gallons
cubic foot	=	6.23 Imperial gallons
1 U.S. gallon	=	3.785 Litres
1 US gallon	=	0.8327 Imperial gallons
1 Imperial gallon	=	4.546 Litres
1 Imperial gallon	=	1.201 U.S. gallons
1 litre	=	0.2642 U.S. gallons
1 litre	=	0.2200 Imperial gallons

Appendix H - Conversion Factors continued

Mass	Multiply by
kg to pounds	2.204
pounds to kg	0.454
kg to grams	1000
mg to grams	1000

Volume to weight

One cubic foot of water	=	62.4 pounds.
One cubic foot of water	=	7.5 gallons. (U.S.)
One cubic foot of water	=	6.24 gallons. (Imperial)
One gallon (U.S.) of water	=	8.3 pounds.
One gallon (Imperial) of water	=	10 pounds.
One litre of water	=	1 kg
One cubic metre of water	=	1000 kg
One cubic yard of water	=	

Other

- * mg/kg = parts per million (ppm)
- * 1 foot head of water = 0.434 lbs. psi pressure
- * Water pressure increases one pound per square inch for each 2.31 feet of depth.
- * One foot of water exerts a pressure of 0.433 pounds per square inch.
- * In pump resistance calculations, one foot of head equals 0.433 pounds per square inch, and one pound per square inch equals 2.31 feet of head.
- * One part per million hardness = 0.058 grains per gallon.
- * 17.24 parts per million hardness = one grain per gallon hardness.