

***Industrial Radiation Processing
With Electron Beams and X-rays***



IAEA
International Atomic
Energy Agency



International
Irradiation
Association

FOREWORD

The International Atomic Energy Agency (IAEA), through its technical cooperation program, coordinated research projects, consultants and technical meetings, conferences, and cooperation with relevant technical societies such as the International Irradiation Association (iiA), is promoting the peaceful use of nuclear and radiation technologies. With the IAEA support, several gamma and electron beam irradiation facilities have been built in developing countries, and some new technologies have been developed and transferred to Member States during the past ten years. For more than 40 years, the iiA (formerly the Association of International Industrial Irradiation, the Aiii) has been an active advocate of the safe and beneficial use of irradiation, representing the interests of industry members and working to enlighten the public and regulators about the advantages of radiation processing using gamma rays, electron beams and X-rays.

In the last decades, radiation processing has been applied in many aspects of national economies. This technology is used in diverse industries to enhance the physical and chemical properties of materials and to reduce undesirable contaminants, such as pathogens or toxic by-products. Worldwide, there are over 1,400 high-current industrial electron beam accelerators in commercial use. There are also approximately 1,000 low-current accelerators used for research purposes and thousands of accelerators that are used in medical diagnostics or for cancer therapy. These research and medical uses of accelerators are not covered in this document.

This document summarizes the basic aspects of electron beam (EB) and X-ray industrial processing, describing the key areas such as, i) industrial EB accelerators, ii) the effects of ionization from accelerated electrons and X-radiation on materials, and iii) major end-use markets and emerging applications. It does not deal with the uses of low-current accelerators for research purposes or the use of accelerators in the medical area for diagnostics or therapy.

The IAEA and the International Irradiation Association (iiA) wish to thank the primary authors and editors Antony J. Berejka and Marshall R. Cleland for their drafting of this publication as well as other contributors to this publication for their valuable contributions. The IAEA officer responsible for this publication was Maria Helena de Oliveira Sampa of the Division of Physical and Chemical Sciences.

CONTRIBUTORS TO DRAFTING AND REVIEW

Auslender, V.L.	Budker Institute of Nuclear Physics, The Russian Federation
Berejka, A.J.	Consultant, United States of America
Bol, J.L.	IBA Industrial, Belgium
Brinston, R.	International Irradiation Association, iiA, Canada
Bryazgin, A.	Budker Institute of Nuclear Physics, The Russian Federation
Calvo, W.A.P.	Instituto de Pesquisas Energéticas e Nucleares, IPEN, Brazil
Chmielewski, A.	Institute of Nuclear Chemistry & Technology, INCT, Poland
Cleland, M.R.	IBA Industrial Incorporated, United States of America
Cokragan, A.	MEVEX Corporation, Canada
Ehlermann, D.A.E.	Institute of Food Engineering, Federal Research Centre for Nutrition, Germany (retired)
Fletcher, M.	Advanced Electron Beams, United States of America
Guven, O.	Hacettepe University, Turkey
Haji-Saeid, M.	International Atomic Energy Agency, Austria
Hamm, R. W.	R&M Technical Enterprises, Incorporated, United States of America
Letournel, E.	Vivirad S.A., France
Machi, S.	Advisor, Ministry of Education, Culture, Sports, Science and Technology (MEXT); FNCA Coordinator of Japan, Senior Advisor Japan Atomic Energy Agency (JAEA), Japan
Malcom, F.	Getinge La Calhene, France
Mastro, N.L.del	Instituto de Pesquisas Energéticas e Nucleares, IPEN, Brazil
Safrany, A.	International Atomic Energy Agency, Austria
Sampa, M.H.O.	International Atomic Energy Agency, Austria
Tallentire, A.	Department of Pharmacy, University of Manchester, United Kingdom (retired)
Testoni, A.	Advanced Electron Beams, United States of America
Vroom, D.A.	Consultant, United States of America
Whitney, W.	Consultant, United States of America
Zimek, Z.	Institute of Nuclear Chemistry & Technology, INCT, Poland

CONTENTS

1.	INTRODUCTION	1
1.1.	Electron Beam Processing Industry	1
1.2.	Energy Transfer	3
1.3.	Electron Beam Parameters	5
1.4.	X-radiation.....	10
2.	ELECTRON BEAM ACCELERATORS	14
2.1.	Historical Development.....	14
2.2.	Electron Beam Sources	17
2.3.	High-energy Accelerators.....	18
2.4.	Mid-energy Accelerators.....	23
2.5.	Low-energy Accelerators	25
2.5.1.	Low-energy EB Compared to Ultraviolet (UV) Radiation.....	29
3.	MATERIAL EFFECTS	30
3.1.	Polyethylenes.....	34
3.2.	Polypropylenes	36
3.3.	Halogenated Plastics: Polyvinyl and Polyvinylidene Chloride, Fluoropolymers	38
3.4.	Engineering Thermoplastics.....	40
3.5.	Elastomers	42
3.6.	Thermoplastic Elastomers	42
3.7.	Monomers and Oligomers	43
3.8.	Grafting.....	44
3.9.	Water Soluble Polymers.....	45
3.10.	Natural Polymers	45
3.11.	Living Matter.....	45
4.	PROCESS DOSIMETRY	49
4.1.	Alanine Dosimetry.....	50
4.2.	Polyethylene Dosimetry.....	52

5.	MAJOR END-USE APPLICATIONS	55
5.1.	Wire and Cable Insulation.....	55
5.2.	Heat-Shrinkable Tubing.....	56
5.3.	Heat-Shrinkable Food Packaging Films.....	57
5.4.	Closed Cell Polyethylene Foams.....	59
5.5.	Tire Components.....	60
5.6.	PTC Heaters and Switches.....	60
5.7.	Inks, Coatings and Adhesives.....	62
5.8.	Hydrogels.....	65
5.9.	Medical Device Sterilization.....	65
5.9.1.	Regulatory Compliance for Sterilization.....	70
5.9.2.	In-line Medical Device Sterilization.....	71
5.10.	Food Irradiation.....	72
5.10.1.	Regulatory Compliance for Irradiated Food.....	74
5.11.	Food and Medical Product Packaging Decontamination.....	75
6.	OTHER APPLICATIONS AREAS	76
6.1.	PTFE Degradation.....	76
6.2.	Water Pipes and Tubing.....	76
6.3.	Battery Separators.....	77
6.4.	Filter Membranes.....	77
6.5.	Semi-conductor Treatment.....	77
6.6.	Gem Stone Irradiation.....	77
7.	EMERGING APPLICATION AREAS	78
7.1.	Cellulose Degradation for Ethanol/Biofuel Production.....	78
7.2.	Cellulose Degradation for Paper and Viscose Production.....	78
7.3.	Water Treatment.....	78
7.4.	Stack Gas Treatment.....	79
7.5.	Exhaust and Gaseous Treatment.....	79
7.6.	Composite Curing.....	79
7.7.	Carbon Fiber Modification.....	80
7.8.	Silicon-Carbide Fiber Manufacture.....	80

7.9.	Fuel Cell Membranes.....	80
7.10.	Fuel Cell Catalyst Modification.....	80
7.11.	PTFE Crosslinking	80
7.12.	Rubber Sheeting	80
7.13.	Seed Disinfestation.....	81
7.14.	Soil Disinfestation.....	81
7.15.	Grafted Biologically Active Compounds.....	81
7.16.	Human Tissue Sterilization.....	81
7.17.	Direct Food Contact Coatings.....	81
8.	ELECTRON BEAM SERVICE CENTERS	82
9.	REFERENCES	86

Tables

Table I	Energy Demand to Dry/Cure Coatings.....	5
Table II.	EB Penetration – Market End-Uses	8
Table III.	Alternative Ionizing Radiation Sources	12
Table IV.	X-ray Processing Through-put Potential	13
Table V.	Temperature Rise of Materials Due to Irradiation.....	34
Table VI.	Radiation Tolerant Formulated Polypropylene Copolymer	38
Table VII.	Properties of Plastic Polymers	41
Table VIII.	EB Grafting of Polymers.....	44
Table IX.	Typical Flame Retardant Wire and Cable Formulation	55
Table X.	Comparison of Solvent Based Drying with EB Curing	64
Table XI.	Medical Disposable Articles Sterilized by Ionizing Radiation.....	66
Table XII.	Electron Beam Processing Service Facilities in the Americas.....	82
Table XIII.	Electron Beam Processing Service Facilities in Europe	83
Table XIV.	Electron Beam Processing Service Facilities in Asia-Pacific and Elsewhere...84	

Figures

Figure 1.	Industrial Electron Beam Accelerator End-Use Markets.....	2
Figure 2.	Direct Current Electron Beam Operating Principles.....	3
Figure 3.	Useful Electron Ranges – Ropt is the equal-entrance = equal-exit depth.....	6
Figure 4.	Energy Deposition in Centimeters of Water for 1.0 to 5.0 MeV EB.....	6
Figure 5.	Electron Beam Penetration in Centimeters of Water (unit density).	6
Figure 6.	Energy Deposition versus Areal Density in HDPE for 75 to 250 keV EB.....	7
Figure 7.	Low-energy Electron Beam Penetration (unit density).....	8
Figure 8.	Illustration of Opposite-sided EB Exposure.....	9
Figure 9.	Forward Peaked Emission of 5.0 MeV X-rays.....	11
Figure 10.	EB, Gamma Ray and X-ray Penetration.....	12
Figure 11.	Lenard’s 1894 Glow Discharge Tube.....	14
Figure 12.	Coolidge’s Electron Tube with Foil Window.....	15
Figure 13.	10 MeV Linac System.....	19
Figure 14.	Relative Lengths of Industrial Linacs.....	19
Figure 15.	Industrial 10 MeV CIRCE Linac Installation with an Inverted Scan Horn.....	19
Figure 16.	The Unipolis 10 MeV Facility.....	20
Figure 17.	30 kW 10 MeV Mevex Linac.....	20
Figure 18.	ILU-14 7.0 to 10 MeV Accelerator.....	20
Figure 19.	Rhodotron Interior.....	21
Figure 20.	Rhodotron Principle.....	21
Figure 21.	10 MeV, 200 kW Rhodotron.....	21
Figure 22.	10 MeV EB Facility.....	22
Figure 23.	5.0 and 7.0 MeV X-ray Facility.....	22
Figure 24.	Totes Ready for X-ray Processing.....	22
Figure 25.	5.0 MeV, 300 kW Dynamitron.....	24
Figure 26.	2.0 MeV, 100 kW ELV	24
Figure 27.	3.0 to 5.0 MeV ILU-10.....	24
Figure 28.	Easy-e-Beam 800 keV, 100 mA.....	24
Figure 29.	Vivirad 2 MeV with Two Cross-firing Beams from One Power Supply.....	25
Figure 30.	Low-energy EB Design.....	26
Figure 31.	Low-energy EB unit.....	26
Figure 32.	Segmented Low-energy EB Filament Array without Beam Window.....	26

Figure 33. 300 keV, 100 mA NHV Curetron for Surface Curing on Flat Substrates.....	27
Figure 34. ESI EZ-CURE III.....	27
Figure 35. Broadbeam LE Series.....	27
Figure 36. 50cm Two Module Unit.....	28
Figure 37. 50cm Two Module Unit Shielded.....	28
Figure 38. Low-energy Modular EB.....	28
Figure 39. Self-shielded Low-energy Applications Development Unit.....	29
Figure 40. UV versus EB Penetration.....	29
Figure 41. Carbon Atom with Electron Added to Yield a Free Radical.....	30
Figure 42. Illustration of Mc in Crosslinked Materials.....	32
Figure 43. Illustration of the Determination of Ggel.....	33
Figure 44. Effect of Comonomer Content on PE Properties.....	35
Figure 45. Crosslinking of Polyethylene.....	36
Figure 46. Chain Scissioning of Polypropylene.....	37
Figure 47. Tetra-substituted Chain Scissioning Halogenated Polymers.....	39
Figure 48. Polyvinylidene Fluoride (PVdF).....	39
Figure 49. Radiation Resistant Cyclic Thermoplastics.....	40
Figure 50. Polyisobutylene Polymers.....	42
Figure 51. Acrylic Monomers used in Inks, Coatings and Adhesives.....	43
Figure 52. Acrylated Oligomers Used as Precursors in Radiation Curing.....	43
Figure 53. Polyethylene Oxide.....	45
Figure 54. Cellulose.....	45
Figure 55. Base Pairs of DNA.....	46
Figure 56. DNA Double Helix.....	46
Figure 57. Survival Fractions with Low Dose Radiation Exposure.....	47
Figure 58. Radiation Induced Double Strand Break of DNA.....	48
Figure 59. EPR Reader with Possible NIST Electronic Traceability.....	51
Figure 60. Loss of 80 keV Electron Beam Energy in Air with Change in Gap Distance.....	51
Figure 61. Alanine/marker Ratio Sensitivity to Beam Current at Very Low Energies.....	52
Figure 62. Transvinylene in Irradiated PE.....	53
Figure 63. Monte Carlo Energy Deposition in 25 μ m HDPE Film.....	53
Figure 64. FTIR Absorbance Transvinylene in HDPE at 965 cm^{-1}	53
Figure 65. Compact ATR FTIR.....	53

Figure 66. ATR FTIR Absorbance at 965 cm ⁻¹ Irradiated HDPE Film.....	53
Figure 67. Concurrent Irradiation of HDPE Sheet, LDPE Film, Alanine Dosimeters.....	54
Figure 68. 125 kV EB Penetration into 38 μm LDPE Film.....	54
Figure 69. Transmission FTIR HDPE Sheet.	54
Figure 70. ATR FTIR LDPE Film.....	54
Figure 71. Wire and Cable Under-beam Transport System.....	55
Figure 72. EB Crosslinked Flame Retardant Insulation	56
Figure 73.. Heat-Shrinkable <i>Tubing</i>	57
Figure 74. Cook, et al. US 3,086,242 of April 23, 1963, Tubing Expander.....	57
Figure 75.. Baird, et al. US 3,022,543 of February 27, 1962, “Double-Bubble” <i>Process</i>	58
Figure 76.. Self-shielded 500 keV Electron Beam for Shrinkable <i>Film</i>	58
Figure 77.. Ten Self-shielded EB Units in One <i>Factory</i>	59
Figure 78.. Automotive Uses EB Crosslinked PE Closed Cell <i>Foams</i>	59
Figure 79. Medical Device Uses of EB Crosslinked Closed Cell Foams.....	59
Figure 80. Cross-section Radial Ply Tire.....	60
Figure 81. Conductive Carbon Black in EB Crosslinked Thermoplastic Binders.....	61
Figure 82. Self-limiting Heating Cable.....	61
Figure 83. PolySwitches.....	61
Figure 84. EB 3D Cured Auto Parts ~1980.....	62
Figure 85. Pigmented Coating Cured with Low-Energy EB.....	63
Figure 86. EB Coating after 1000 Hours Salt Spray.....	63
Figure 87. EB Coating after Mandrel Bend Test.....	63
Figure 88. EB Cured Coating on Tubular Aluminum.....	63
Figure 89. Diverse Array of Low-Energy EB Cured Pigmented Coatings.....	63
Figure 90. Hydrogel Dressing.....	65
Figure 91. Hydrogel Used in Burn Treatment.....	65
Figure 92. Diverse Disposable Medical Devices.....	66
Figure 93. Flexible PVC as a Replacement for Glass.....	67
Figure 94. Polyolefin Laminate as a Replacement for Flexible PVC.....	67
Figure 95. Disposable Plastic Syringes.....	67
Figure 96. PS Drainage Monitoring Unit.....	68
Figure 97. Disposable PC Cartridge for Hyperbaric Chamber.....	68
Figure 98. Various Silicone Rubber Medical Products.....	68

Figure 99. Non-adherent Silicone Wound Dressing.....	68
Figure 100. Rotation of Product on a Palletron in Front of an X-ray Target.....	69
Figure 101. Monte Carlo Illustration of Uniform Dose Distribution for Rotating Product...	70
Figure 102. 2.0 MeV Linac for In-line Medical Device Sterilization.....	71
Figure 103. In-line Packaging Sterile Product.....	71
Figure 104. Self-shielded In-line Medium Energy System for Device Sterilization.....	72
Figure 105. Red Meat (4.5 kGy max.) and Poultry (3.0 kGy max.).....	73
Figure 106. Spices (30 kGy max.).....	73
Figure 107. Symbol for Irradiated Food.....	74
Figure 108. STERSTAR™ System for In-line EB Surface Decontamination.....	75
Figure 109. Schematic of Tri-angulated 200 keV EB Accelerators.....	75
Figure 110. 12 Meter PE Pipe for EB Crosslinking.....	76
Figure 111. Irradiated Gem Stones.....	77
Figure 112. Water with Residual Dye Contaminants being EB Treated.....	78
Figure 113. Flue Gas Irradiation Chamber with EB Unit.....	79
Figure 114. Interior of Double Beam Window in Flue Gas Chamber.....	79
Figure 115. X-ray Cured Carbon Fiber Composite Sports Car Fender.....	80
Figure 116. X-ray Cured Carbon Fiber Composite Motorcycle Fender.....	80

1. INTRODUCTION

There has been an IAEA document on **Gamma Irradiators for Radiation Processing**, published in 2005. In response to the Member States requests that a similar document reviewing industrial electron beam processing be prepared, the IAEA in cooperation with the industrial association, the iiA, organized a Consultants Meeting at the IAEA headquarters in Vienna in July 2008 to review and discuss the first draft prepared by A.J. Berejka and M.R. Cleland. The document was modified and first distributed to well known experts in the field for review and the International Meeting on Radiation Processing (IMRP 2008) held in London in September 2008. A revised version 1a was presented and reviewed at the American Nuclear Society/IAEA cosponsored International Topical Meeting on Nuclear Research Applications and Utilization of Accelerators (AccApp'09) held at the IAEA headquarters in May 2009. Since then, the document has been revised several more times to take into account the comments from a larger group of experts. Suggestions and input based on comments from the reviewers were incorporated into the present document.

This document is intended to be an introduction to the industrial use of accelerators. It provides information on the historical development of accelerator technology and on some of the numerous types of accelerators which have found acceptance in commerce, making value-added products for use in trade. Other texts and resources, often noted by reference, delve into the particulars of accelerator design. Accelerators are electrical devices which can be turned on or off as any other industrial electrical equipment. While producing ionizing radiation, the EB units used in industry for commercial purposes do not generate radioactivity. EB installations do not face the security, transportation and disposal issues that confront the use of long lived, gamma-ray emitting isotopes, such as cobalt-60, which are used in a few industrial applications, such as mainly for medical device sterilization. With the advent of very high-current EB accelerators, conversion of electron beam power to X-radiation is now an alternative to the industrial use of gamma rays [1, 2]. Radioactive gamma sources used in commercial applications are made available in a common rod shape containing the isotope, with there being some variation in facility designs [3]. In contrast, there is a very diverse array of industrial accelerators with many designs having been customized for specific commercial end use applications.

This document also treats, in an introductory manner the basics of radiation chemistry, and goes into the significant commercial end uses in which this chemistry has provided societal benefits. Emerging uses and applications are also discussed. Finally, lists of service facilities are provided. Although not exhaustive, these lists are of value to potential users of industrial electron beam processing in that product, process and commercial development can be conducted without the potential users having to commit to the capital investment in an accelerator and a dedicated facility.

1.1. Electron Beam Processing Industry

High-current electron beam (EB) accelerators are used in diverse industries to enhance the physical and chemical properties of materials and to reduce undesirable contaminants, such as pathogens or toxic by-products. Very conservative market surveys indicate that there are >1400 high-current EB units in commercial use providing an estimated added value to

numerous products of >\$85 billion USD or even more [4, 5, 6, 7]. This number of units does not include the nearly 1000 accelerators that are low-current devices used for research purposes, such as Van de Graff generators, low-energy EB laboratory units, many pulsed linear accelerators, or the thousands of accelerators that are used in medical diagnostics or for cancer therapy. Nor does this include particle accelerators used for ion implantation or electron beam welding equipment. There are eight to nine times more commercial EB units in world-wide operation than commercial gamma-ray irradiators [8]. Electron beam accelerators are reliable and durable electrically-sourced equipment that can produce ionizing radiation when it is needed for a particular commercial use [9, 10]. As noted, with the advent of very high-current EB accelerators, conversion of electron beam power to X-radiation can be used as an alternative to the industrial use of gamma rays. Major end-use applications for high-current industrial EB accelerators are illustrated in the pie chart below (Figure 1). Specific accelerator energies, which govern the electron beam penetration, are preferred in certain market areas. A later section of this document deals with each of these application areas in more detail. Different end-use areas tend to use different under-beam handling systems. Wire and cable and heat-shrinkable tubing and the emerging use of EB crosslinked polyethylene tubing for water distribution rely upon a multiple-pass system referred to as a “race-track” system (Figure 71). EB units for surface curing are installed on printing presses and coatings lines. Most of the heat-shrinkable film as used for food packaging is crosslinked before the film is blown into its finished dimensions. Some heat-shrinkable film is irradiated as sheet as are tire components. Service centers often rely upon cart-type conveyor systems that handle diverse product forms and items.

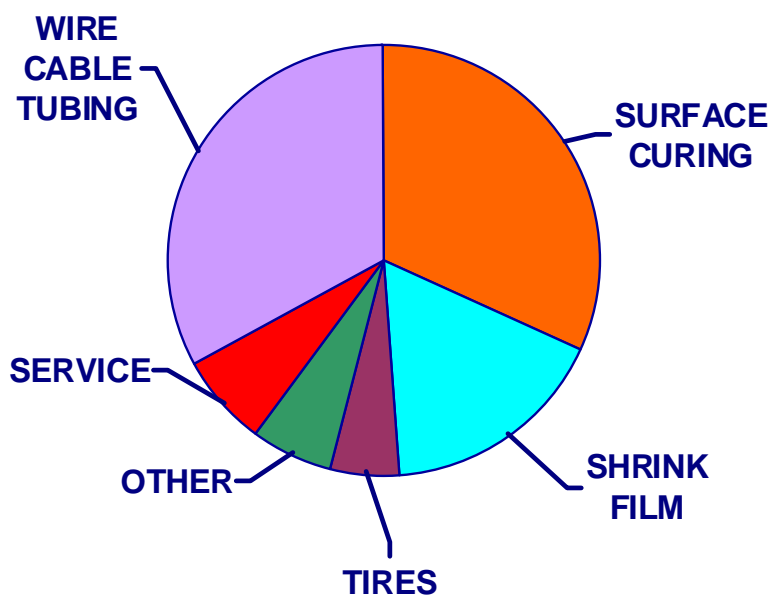
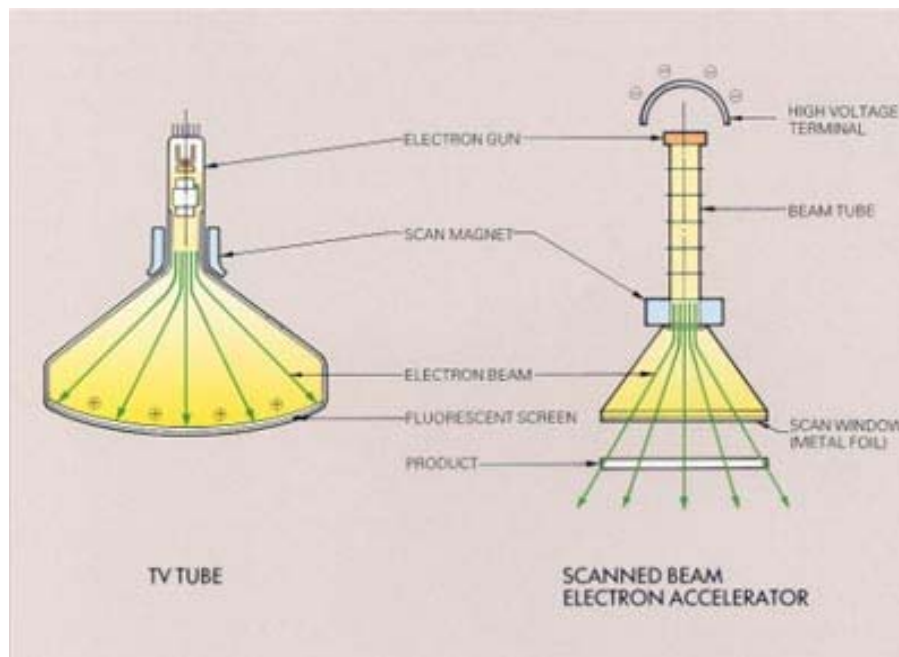

Figure 1. Industrial Electron Beam Accelerator End-Use Markets

All electron beam accelerators have some common features: 1) electrons are emitted from heated cathodes; 2) electrons are focused into a beam with an extraction electrode; 3) electrons are accelerated within an evacuated space with a strong electric field. Electrons pass into the air through a thin titanium-foil window. Accelerators differ in how they attain the final electron energy, which is determined by the electronic charge times the voltage in direct current (dc) accelerators. For microwave linear accelerators (linacs), the energy is determined by the electronic charge times the forward electric field integrated over the path length. The electron energy may be expressed in electron volts (eV), kiloelectron volts (keV) or megaelectron volts (MeV). Figure 2 illustrates that the principles for electron acceleration used in direct current EB equipment are similar to those used in cathode ray (CRT) or television picture tubes, but they operate at significantly higher voltages; CRTs and TVs typically operate at ~25,000 volts, much lower than any industrial accelerator [11].



*Figure 2. Direct Current Electron Beam Operating Principles
(Diagram provided by IBA Industrial Incorporated)*

1.2. Energy Transfer

In manufacturing operations, the energy needed to affect materials can be transferred by three different means [12]:

- a) convection – as in the use of ovens with heated forced air to dry inks, coatings or adhesives.
- b) conduction – as in the transfer of heat from embedded resistance heaters through the metal of molds used in curing and thermo-forming products.
- c) radiation – accelerated electrons or photons, ranging from radio-frequencies, microwaves, infra-red (heat) radiation, light, ultraviolet radiation, X-radiation and gamma rays.

Of these various forms of radiation, accelerated electrons and short wavelength (4.1×10^{-3} nm) X-radiation and gamma-ray (1.0×10^{-3} nm) photons interact with matter at the atomic level. Radio-frequency and microwave radiation, which can penetrate materials, require a polar material in order to induce sufficient molecular vibration to generate heat and thereby cause chemical or material responses. In industrial applications, light and ultraviolet (UV) radiation are limited to surface effects and depend upon the use of costly photo-sensitive compounds which decompose upon exposure and thereby initiate chemical reactions. The energy dependence on radiation wavelength is given by:

$$E = hc/\lambda$$

where E is the energy in joules; h is Planck's constant (6.626×10^{-34} joule-seconds); c is the speed of light in vacuum in meters per second (2.998×10^8 m/s) and λ is the wavelength in meters. One electron volt (1.0 eV) = 1.602×10^{-19} joules.

Typical peak wavelengths for mercury vapor UV curing lamps are between 240 and 270 nm and between 350 and 380 nm. The photon energy equivalent at these wavelengths is between 5.2 eV and 3.3 eV (the shorter wavelengths having more energy). The typical ionization potential for organic or polymeric materials is ~ 10 eV. Therefore, UV radiation is not effective in producing ionization without an initiator. On the other hand, for high energy X-radiation the most probable photon energy is ~ 300 keV which is far above the ionization potential of any substance. High energy X-rays are at much shorter wavelengths, 4.1×10^{-3} nm, orders of magnitude shorter than ultra-violet (UV) radiation.

The electrical energy conversion efficiency for electron beam accelerators, the ratio of the input electrical power to output beam power, ranges between 25% and 75% depending upon the design of a specific accelerator [13]. In general, direct current accelerators with lower energies are more efficient in terms of energy conversion than RF or microwave linacs. In the drying or curing of coatings, a typical use for low-energy electron beam accelerators, the energy efficiency of EB processing can be contrasted with historic uses of solvent drying or with emerging uses of the supposedly environmentally friendly, but energy consumptive, water-based technologies. Table I presents the energy demand needed to attain comparable dried coating weights. Taking into account energy demands for forced air drying, solvent recovery and incineration, EB processing is about two orders of magnitude more efficient. This assumes 70% power conversion efficiency, input line power to electron beam output power, for a low-energy unit [14]. In the Systeme International (SI), the gray is a unit of measure for the energy of ionizing radiation that is absorbed by a mass. One gray is equal to 1 joule per kilogram and 1 kilogray (kGy) is equal to 1 joule per gram, (J/g).

In this major and fast growing market segment of surface curing (Figure 1), electron beam processing is not only energy efficient, but also enables users to comply with restrictions on the emissions of volatile organic compounds (VOCs) which can form greenhouse gases. This is a major environmental and societal benefit achieved by EB processing [15].

Table I. Energy Demand to Dry/Cure Coatings

System:	Solvent	Solvent	Water	EB Curable
Solids:	30%	40%	40%	100%
Diluent:	heptane	toluene	water	none
Boiling point, °C:	98	111	100	---
Vapour pressure, 20°C	35 mm Hg	22 mm Hg	17 mm Hg	---
Heat of vaporization: (calories/gram diluent)	76	88	540	---
Energy to dry/cure 1 g dried coating: (calories/gram diluent)	177	132	810	7
Energy just to dry/cure 1 g dried coating, J/g:	740	555	3390	(at 30 kGy) 30

1.3. Electron Beam Parameters

There are two fundamental properties of all electron beam accelerators: the electron energy and the beam current. Since electrons have mass and electrical charge, their penetration into materials is limited by their kinetic energy and by the mass and density of the target material. The amount of exposure to electrons is called the absorbed dose, which is characterized in the Systeme International (SI) as the gray, where 1 gray = 10^4 ergs/gram, or as commonly used in industrial processing, the kilogray (kGy) where 1 kGy = 1 J/g absorbed energy per mass. Industry relies upon electron beam energies ranging from 75 keV to 10 MeV. Lower energies will lose excessive beam power in the beam window and in air; higher energies involve the risk of induced radioactivity. For mid-energy (500 keV to 5 MeV) and high-energy (5 MeV to 10 MeV) electron accelerators, it is common to express beam penetration on the basis of equal-entrance, equal-exit exposure in unit density material. Figure 3 illustrates depth-dose relations where R_{opt} (optimum depth) is the equal-entrance, equal-exit parameter; R_{50} is the depth where the exit dose is 50% of the maximum dose; R_{50e} is the depth where the exit dose is 50% of the entrance dose; and R_p is the depth where the tangent line at the inflection point of the decreasing curve intersects the depth axis [16]. Figure 4 shows the depth-dose distribution curves for beam energies between 1.0 and 5.0 MeV in centimeters of water as derived from Monte Carlo calculations using the ITS3 (Integrated Tiger Series) code [17]. Figure 5, in a simplified way, shows this dependence of EB penetration on electron energy in the mid to high-energy area as a linear function using the equal-entrance, equal-exit criteria also in centimeters of water or unit density materials [11, 18, 19, 20].

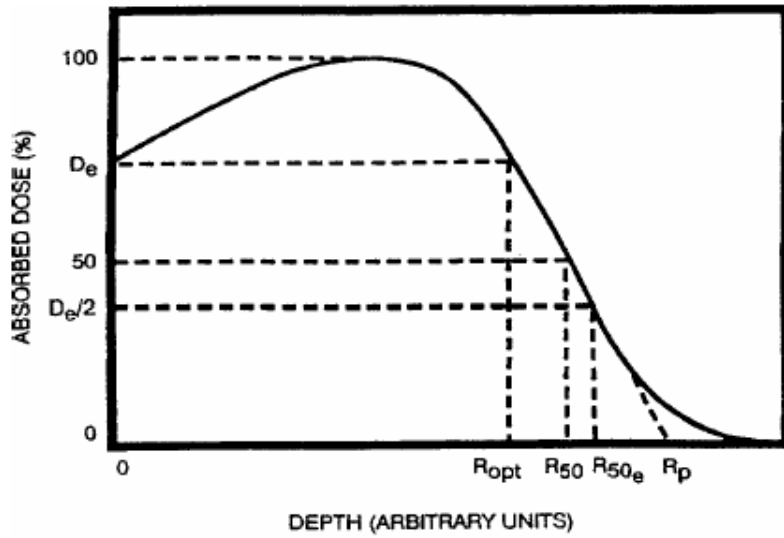

Figure 3. Useful Electron Ranges – R_{opt} is the Equal-entrance = Equal-exit depth

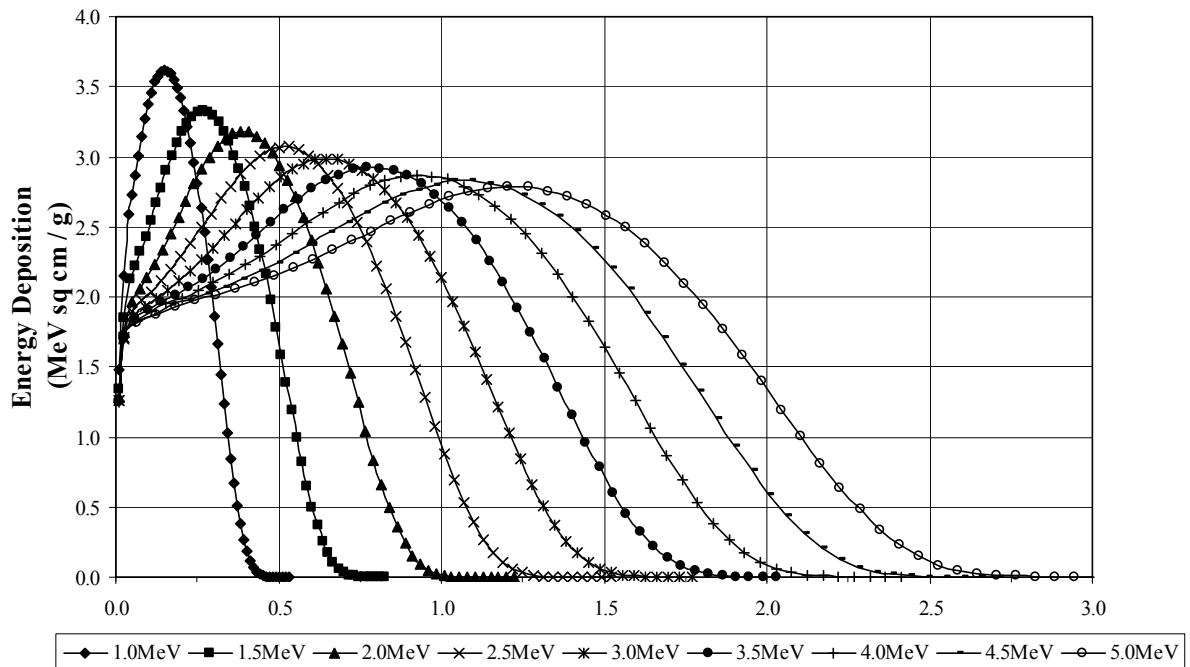

Figure 4. Energy Deposition in Centimeters of Water for 1.0 to 5.0 MeV EB

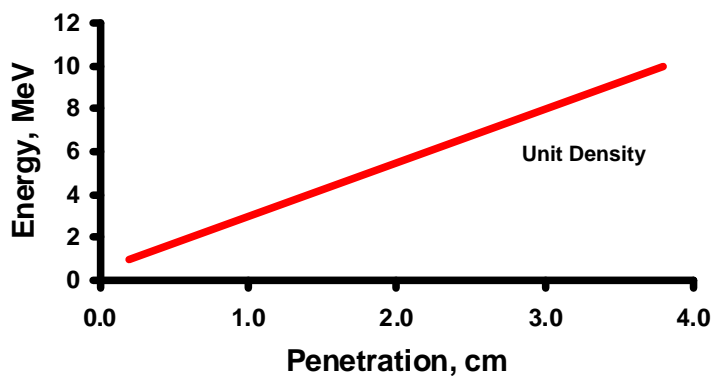

Figure 5. Electron Beam Penetration in Centimeters of Water (unit density)

Figure 6 illustrates the depth-dose distribution curves for low-energy beams between 75 keV and 250 keV in g/cm^2 of high density polyethylene (HDPE at 0.95 g/cm^3 density), assuming a titanium window thickness of $6.0 \mu\text{m}$ and an air space from window to polyethylene of 2.5 cm . This figure is also based upon Monte Carlo calculations using the ITS3 (Integrated Tiger Series) code [21]. The output from the Monte Carlo code is given in thickness times density or the weight per unit area. This quantity, also called the areal density, of a film or sheet of material is proportional to the number of molecules per square centimeter (cm). This is also proportional to the energy deposited by an accelerated electron when passing through the film or sheet of material. Vertical lines highlight the distinction between electron absorption in the three layers being considered: the titanium (Ti) window, the air gap and the polyethylene.

Figure 7 is the simplified depiction of such data as a linear function using the equal-entrance, equal exit criteria, in unit density and the depth of penetration in microns, μm . In the low-energy electron beam area, coating coverage expressed in grams per square meter (g/m^2), is equal to thickness in μm for unit density, 1.0 g/cm^3 , materials. Changes in formula density due to pigment loadings and the like require corrections to be made in proportion to the formula density; higher density formulations will have a proportionally lower thickness given the same area coverage.

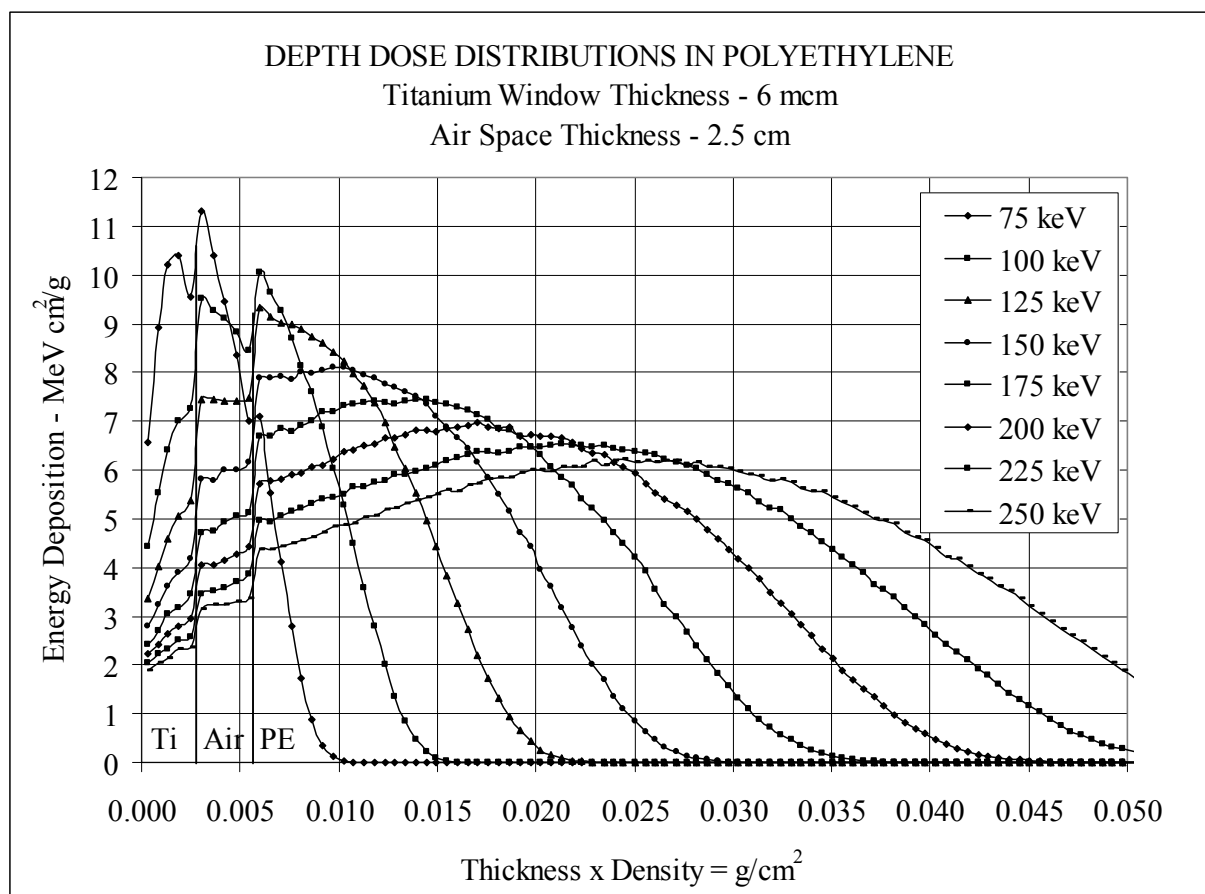

Figure 6. Energy Deposition versus Areal Density in HDPE for 75 to 250 keV EB

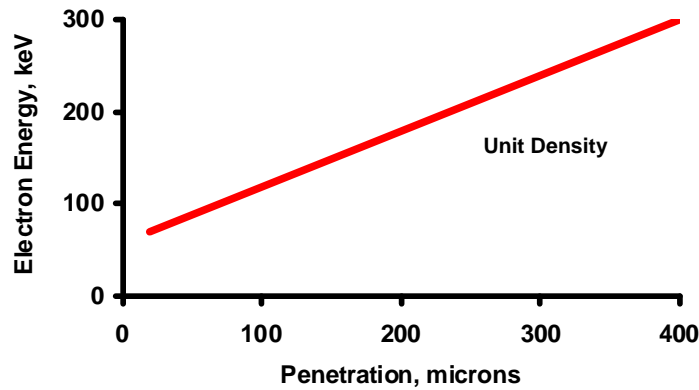

Figure 7. Low-energy Electron Beam Penetration (unit density)

Over the decades of industrial use, the key market segments (Figure 1) have found reliable industrial accelerators suited to their demands. Table II summarizes this for materials that are close to unit density and at commonly used electron beam energies.

Table II. EB Penetration – Market End-Uses

Market Segment	Electron Energy	Typical Penetration
Surface Curing	80 – 300 keV	0.4 mm
Shrink Film	300 – 800 keV	2 mm
Wire & Cable	0.4 – 3 MeV	10 mm
Sterilization	3 –10 MeV	40 mm

Corrections for material density have to be made in order to assess the appropriate voltage for a given application. For example, fillers used in coating formulations and in wire and cable compounds will increase product density. A carbon fiber composite (density 1.6 g/cm³) will only be penetrated on an equal-entrance, equal-exit basis to 24 mm using a 10 MeV beam, whereas low bulk density items, such as packaged medical disposables (density 0.25 g/cm³), can be effectively penetrated at >160 mm at 10 MeV [22]. Given an overlap of tail ends of the depth-dose penetration, opposite-sided electron beam exposure results in an effective 2.4 multiple of the EB penetration itself [23]. Thus, fairly large, low bulk density packages can be irradiated if the item is turned over during processing. Figure 8 illustrates this effect of opposite-sided EB treatment.

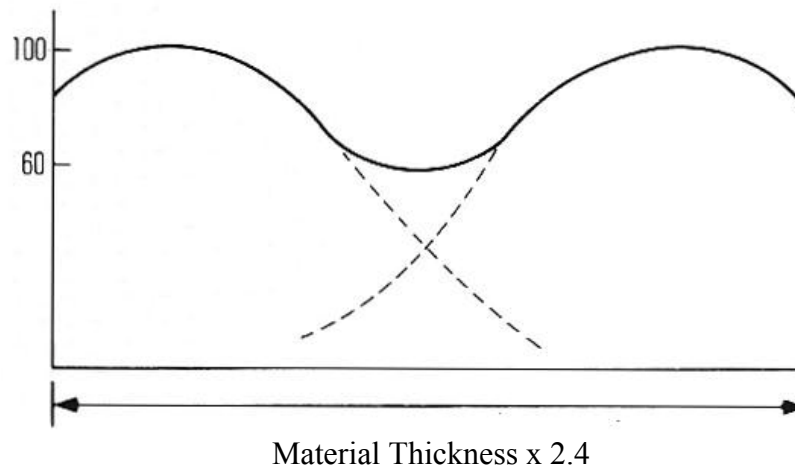

Figure 8. Illustration of Opposite-sided EB Exposure

High beam current is what distinguishes industrial electron beam accelerators from equipment that is commonly used solely for research purposes. Most industrial accelerators have beam currents in the tens of milliampere range (>10 mA). Research equipment, such as Van de Graaff accelerators, Pelletrons™, and many linacs operate in the microamp range (orders of magnitude lower in beam current than industrial equipment). High beam currents are desired in industry because product through-put rates are proportional to beam current. For estimating processing rates, an area through-put equation is often used.

$$\text{Area processing rate} = W_b V_l = 6.0 D(e) F(i) I/D$$

where W_b = beam width in m; V_l = line speed in m/min; $D(e)$ is the energy deposited per electron per areal density in units of MeV/(g/cm²); I = beam current in mA; D = dose in kGy; $F(i)$ is the fraction of the emitted beam current intercepted by the irradiated material. In practice, the factors $6.0 D(e)F(i)$ are often represented by the letter “K” which is then called the Surface Area Rate or Processing Coefficient. The factor $D(e)$ can be derived by an appropriate Monte Carlo code. The factor $F(i)$ must be determined empirically based on the geometry of the irradiation process [20, 24].

An equation derived from the area through-put equation is a product line speed equation wherein the factor “k” is the Area Processing Coefficient, K, divided by the web width, W. This is how the Linear Processing Coefficient, k, is commonly used in the low-energy EB area in relating beam current to line speed [25, 26].

$$\text{Line speed in meters/minute} = k \cdot \text{beam current in mA/dose in kGy}$$

wherein k is typically ~10 to 30 depending on the electron energy, the web width, window thickness and air gap between the window and product.

An alternative through-put equation is used when processing bulk materials. Similar area through-put and bulk through-put equations exist that are used in the mid to high-energy areas. Here the power of the beam (kilowatts = electron energy in MeV x beam current in mA) is taken into consideration. For bulk processing:

$\text{kg/hour} = \text{emitted beam power in kW} \cdot 3600 \cdot \text{utilization efficiency/dose in kGy}$

wherein 3600 converts the time units from seconds to hours [27].

In practice, the efficiency with which the beam power is used depends upon the under-beam handling system and the size and shape of the object being irradiated. Depending upon the end use application, different means of under-beam presentation have been developed. Cart systems commonly used in electron beam service centers may have efficiencies of only 20% to 30%. For wire handling, it has been estimated that the under-beam efficiency is ~35%; for thick sheet (as would be the case in tire components) ~60% [27, 28]. Some film handling systems utilize an under-beam festooning system that enables more than 50% of the beam power to be captured in the product. Likewise, water treatment systems have been developed for directing the scanned electron beam directly into an upward flowing stream of liquid; thereby using most of the beam power [29].

Since material through-put is dependent upon beam current and beam power, one can thus see why industry prefers to use high beam current and high power accelerators. High beam currents also imply very high dose rates. Industrial electron beam dose rates are in the order of 100 kGy/second or 360,000 kGy/hour. This is five orders of magnitude greater than the dose rates from cobalt-60 gamma-ray sources, which are ~10 kGy/hour or 2.8×10^{-3} kGy/second, as shown in Table III. Research accelerators, such as Van de Graaff generators, have dose rates of ~10 to 100 kGy/hour, which is much closer to gamma-ray sources. Because some material effects are dose-rate sensitive, conclusions and inferences drawn from low dose-rate experiments must be judged with caution. It is preferable to replicate any such experiments conducted at low dose-rates by using high-current industrial electron beam equipment.

1.4. X-radiation

When an accelerated electron impinges upon any material, it generates X-radiation or X-rays. Characteristic monoenergetic X-ray photons are produced by the electron interaction with orbital electrons; bremsstrahlung photons are produced by the interaction with the nucleus of an atom. High energy bremsstrahlung X-rays are a penetrating form of ionizing radiation. Such X-ray intensities from high power, high energy industrial X-ray generators far exceed those of common medical X-ray equipment. As a result, thick shielding is needed to prevent worker exposure to high levels of X-radiation. Shielding thickness increases with maximum energy of the X-rays. For low energy EB equipment (75 to 500 keV), shielding has been accomplished using lead. However, concerns over the costs and safe use of lead have prompted newer self-shielded EB equipment to be made using steel shielding. Mid to high energy beams are usually shielded using concrete [4]. In all cases, care is taken to assure that scattered X-rays do not leak from the facility through portals or entrances to the under-beam area. Labyrinths with three or four corners are used so there is negligible radiation in the working area [30].

With the advent of very high-current, mid and high-energy accelerators, X-radiation can now be used as an alternative to the use of radioactive isotopes in such areas as medical device sterilization and food treatment [1, 2, 31]. X-rays are produced by interposing a metal

target between the electron beam and the product to be treated. To enhance electron-to-photon conversion, these X-ray targets are made of high atomic number (high Z) metals [32, 33, 34]. Water-cooled tantalum is preferred for large area targets. The conversion efficiency of electrons to X-radiation depends on accelerator energy and the target Z-value; efficiencies ranging between 8% and 12% have been shown for electron energies between 5.0 MeV and 7.5 MeV. X-radiation has a forward peaked emission and the rate at which a material receives X-radiation photons, the dose-rate, can be controlled by a combination of the distance from the target, the beam current and under-beam transport speed. Very high power, high electron energy accelerators (300 kW at 5.0 MeV or 700 kW at 7.0 MeV) compensate for the inefficiencies of X-ray conversion [35, 36]. Figure 9 illustrates the forward peaked emission of X-rays, which is significantly different from the panoramic emission of gamma-ray sources. This property facilitates the treatment of single pallet loads of product. Figure 10 shows that X-ray penetration is much greater than the highest energy industrial EB systems, 10 MeV, and comparable to gamma ray penetration. Table III summarizes some of the properties of EB, X-ray and gamma-ray sources. X-ray dose-rates are at least one order of magnitude higher than gamma rays, but significantly less than EB. Product through-put rates for X-ray processing based on high power EB equipment, as could be used in medical device sterilization or food irradiation, can exceed that of high electron energy, low to medium power 10 MeV linacs that are used in industrial applications, as shown in Table IV [37].

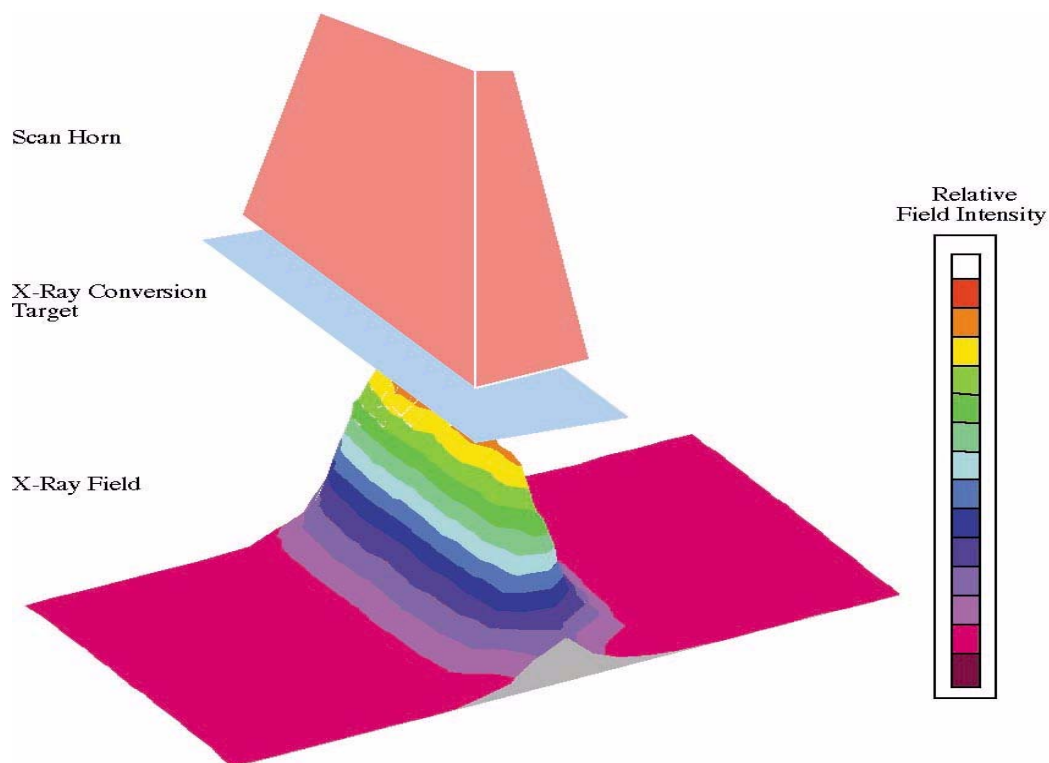

Figure 9. Forward Peaked Emission of 5.0 MeV X-rays

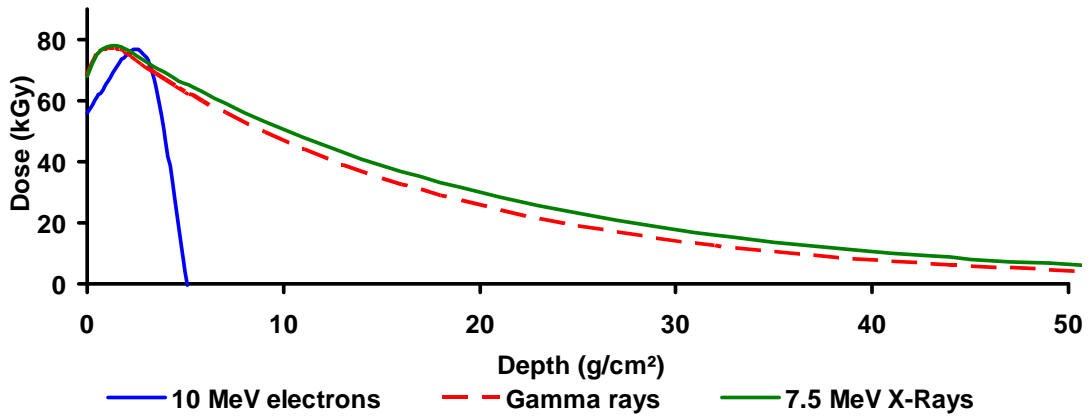

Figure 10. EB, Gamma Ray and X-ray Penetration

The attractive features of X-ray processing for industrial applications are thus:

- + Greater depth of penetration, allowing for treatment of products with large volumes, such as pallet loads of packaged medical devices and food.
- + Controllable dose-rates, which can facilitate monomer polymerization.
- + Not a thermal process, which eliminates adverse effects on materials due to heat.

Table III. Alternative Ionizing Radiation Sources

	Electron Beams	X-rays	Gamma Rays
Power source:	Electricity	Electricity	Radioactive isotope (mainly cobalt-60)
Power activity:	Electrical on-off	Electrical on-off	5.27 year half-life
Properties:	Electrons mass = 9.1×10^{-31} kg	Photons $\lambda = 4.1 \times 10^{-3}$ nm	Photons (1.25 MeV) $\lambda = 1.0 \times 10^{-3}$ nm
Charge:	1.60×10^{-19} coulombs	None	None
Emission:	Unidirectional (can be scanned and bent by magnets)	Forward peaked	Isotropic
Penetration:	Finite range	Exponential attenuation	Exponential attenuation
Dose-rate:	360,000 kilogray/hour 100 kGy/second	100 kilogray/hour 2.7×10^{-2} kGy/second	10 kilogray/hour 2.8×10^{-3} kGy/second

Table IV. X-ray Processing Through-put Potential

Source	Equal-entrance, Equal-exit Penetration in Unit Density, mm	Emitted Power, kW	Potential Through-put, kg/h
10 MeV linac EB mode	38	20	720
10 MeV Rhodotron™ EB mode	38	200	7200
10 MeV linac 20 kW X-ray mode	480	3.2	109
7 MeV Rhodotron 700 kW X-ray mode	450	77	2772
5 MeV Dynamitron™ 300 kW X-ray mode	385	24	864

Assuming an under beam process efficiency of 25% (typical of cart systems) and a dose of 25 kGy and X-ray conversion efficiencies of 16% at 10 MeV, 11% at 7 MeV, and 8% at 5 MeV.

2. ELECTRON BEAM ACCELERATORS

2.1. Historical Development

In 1894, Philipp Lenard observed a glow emanating from a Crookes gas discharge tube with a thin metallic window when an electric current was passed through it. This was the first observation of electrically sourced external radiation. Figure 11 is Lenard's own sketch of the tube he was using. In 1895, Wilhelm Roentgen did significantly more analysis of the emissions from Crookes tubes, including the observation that some rays traveled through space and solid materials and could excite phosphors on a photographic plate. Roentgen called these invisible emissions X-radiation, since at the time their properties were not characterized. These early discoveries from electrically produced radiation and its later derivations have resulted in many commercial and medical applications. The following year, 1896, Henri Becquerel first observed what is now called radioactivity. Becquerel in fact used Roentgen's luminescent techniques to confirm his observations. At the beginning of the twentieth century at the Cavendish Laboratory in Cambridge, England, J. J. Thomson showed that the plasma inside such gas discharge tubes could be bent by magnetic forces. One of his students, Ernest Rutherford then delineated some differences amongst these sub-atomic emissions. Rutherford later collaborated with one of his students, Niels Bohr, to depict the structure of the atom as having a nucleus with orbiting electrons [38].

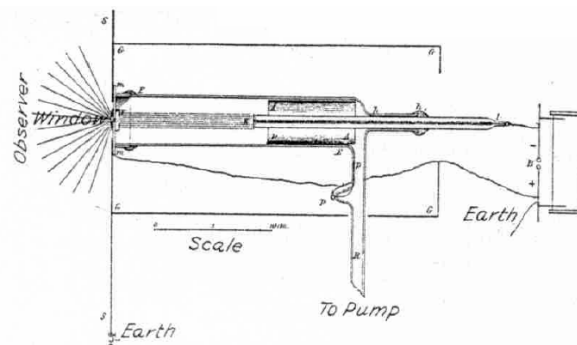

Figure 11. Lenard's 1894 Glow Discharge Tube

The Hittorf-Crookes glow discharge tubes Lenard and Roentgen had used were improved during the early twentieth century and were often used for medical radiography. In 1913, William Coolidge at the General Electric Company applied for a patent on a high-vacuum tube with thermionic cathode instead of a gas discharge to produce an internal electron beam [39, 40]. This gave him greater control over the electrical power he used in his experiments. He thus created the prototype of modern electron beam accelerators. In 1925, he placed a thin foil window at one end of a high vacuum tube and applied for a U.S. patent, as shown in Figure 12 [41, 42]. Coolidge studied the effects of electron beam irradiation on a variety of materials using a 200 keV tube [43]. One of Coolidge's protégés at General Electric, Willem Westendorp developed one of the first industrial electron beam accelerators, the GE resonant transformer, which was patented in 1940 [44]. While intended to be a high voltage source for X-rays, the GE resonant transformer was also used in some of the very first industrial endeavors in electron beam processing.

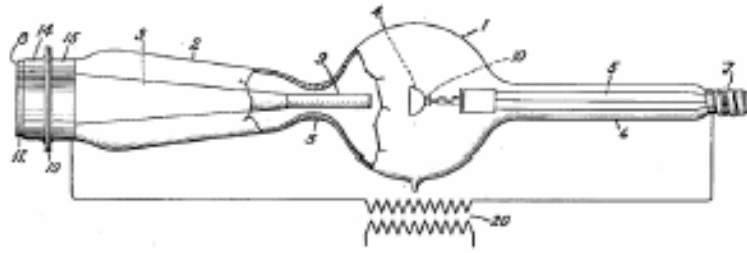

Figure 12. Coolidge's Electron Tube with Foil Window

Also in the early 1930s, John Cockcroft and Ernest Walton, two of Rutherford's students, developed circuitry for increasing the voltage for particle discharge [45]. First used for proton acceleration, the Cockcroft-Walton design principles remain the basis for many high-current, mid-energy electron accelerators currently used in industry.

Roentgen (1901), Lenard (1905), Thomson (1906), Bohr (1922) and Cockcroft and Walton (1951) were all Nobel laureates for their pioneering contributions in physics. Rutherford (1908) attained his Nobel Prize in chemistry.

Another industrially relevant early development was the concept of a radiofrequency linear accelerator as proposed by Gustaf Ising and elevated to an effective piece of equipment by Rolf Wideröe in the mid-1920s [46]. In 1937, when William Hansen and Russell and Sigurd Varian developed the klystron amplifier, the power levels of microwave linear accelerators (linacs) could be increased [47, 48, 49]. Linacs with one or two milliamps of average beam current at 10 MeV are used for medical device sterilization and food treatment.

In 1935, while at the Massachusetts Institute of Technology (MIT), Robert Van de Graaff, received a patent on his electrostatic generator which is widely used in radiation research [50]. Karl Compton, the brother of Arthur Holly Compton, assisted Van de Graaff in preparing his patent. The concept was to develop a high voltage generator for X-rays which would then be used for cancer therapy. This was improved upon by Van de Graaff's colleague, John Trump, another MIT professor, and patented in 1941 [51]. In 1947, following World War II, Van de Graaff and Trump formed the High Voltage Engineering Company (HVEC). Van de Graaff designed a single-phase insulating core transformer (ICT) accelerator and filed for a patent in 1957, which was issued in 1965 [52]. This was improved upon by Roy Emanuelson, an HVEC engineer, using a three-phase version that was commercially viable, with the newer design patented in 1966 [53]. In 1983, HVEC withdrew from the accelerator business and the ICT accelerator technology was subsequently adopted by several companies: Vivirad-High Voltage (VHV) [54], the Cryovac division of the Sealed Air Corporation, Nissin-High Voltage (NHV) and Wasik Associates. Many ICTs are still in use in industrial applications, as for crosslinking wire and cable jacketing and shrinkable films, having been produced in the 300 keV to 2.5 MeV energy range.

Concurrent with Van de Graaff's and Trump's work following World War II was that of Arno Brasch and Wolfgang Huber who formed the Electronized Chemicals Corporation. Brasch and Huber built a high voltage, up to 3.5 MeV, pulsed accelerator, based on capacitor banks being charged in parallel and discharged in series, as in a Marx generator [55, 56]. With this pulsed accelerator, which they called the Capacitron™, they showed that short pulses of high voltage, high current electron beams could kill bioburdens in food and effectively sterilize and preserve food with minimum damage to other properties, such as the

nutritional value and texture of food [57, 58]. Electronized Chemicals Corporation also developed patents on the treating of plastics and was subsequently acquired by High Voltage Engineering Corporation.

A different approach to an accelerator based on a parallel capacitive-coupled, cascaded rectifier, direct-current circuit was developed by Marshall Cleland who applied for his patent in 1956 which issued in 1959 [59]. Having been rejected by HVEC in attempting to license his technology, Cleland followed the advice of Arthur Holly Compton, then Chancellor of Washington University in St. Louis, and went to the New York City area to obtain venture capital. There along with a graduate school classmate, Kennard Morganstern, they founded Radiation Dynamics, Incorporated (RDI) in 1958. The robustness of Cleland's design, RDI's Dynamitron™, is attested by their high industrial reliability and by the fact that many older pieces of equipment are still operational. The Dynamitron can attain the combination of higher electron energy and higher beam currents than the ICT or the Cockroft-Walton series-coupled systems. The Dynamitron can operate at up to 5.0 MeV with total beam power up to 300 kW. Accelerators similar to the Dynamitron are being made in China, but at lower beam currents. RDI is now part of Ion Beam Applications (IBA) and is now known as IBA Industrial, Inc.

An analog of the Dynamitron capacitive-coupled circuitry relying upon magnetic parallel coupling was developed in the former Soviet Union and forms the basis for the ELV electron beam accelerators produced by the Budker Institute of Nuclear Physics in Novosibirsk, Russia. These industrial accelerators have been produced since 1971 and have dominated market applications in Eastern Europe. ELV accelerators operate between 400 keV and 2.5 MeV with a maximum beam power of 400 kW at 1.0 MeV [60, 61]. The Budker Institute has also developed high current pulsed beams, radiofrequency accelerators, the ILU systems, which operate between 700 keV and 5.0 MeV with a high current version, 10 MeV at 100 kW, under development that will be suitable for X-ray conversion [62, 63, 64, 65, 66, 67]. A collaborative venture with the South Korean company EB-Tech has been formed to broaden the marketing base for these technologies.

Another Russian institute, the Efremov Research Institute of Electrophysical Apparatus in Saint Petersburg, also produces a variety of industrial electron accelerators. These range between 0.5 and 2.5 MeV with electron beam power ratings up to 100 kW. Some of these are being tailored for environmental applications, such as stack gas irradiation [68]. Many research and industrial accelerators and their applications have been described in the literature [69, 70].

In the early 1960s, interests by Bill Burlant at the Ford Motor Company in using low energy electron beams (400 keV or less) to cure coatings led to the development of cable connected scanned beams by RDI [71, 72]. To capitalize on the opportunity for coatings at Ford, the paint company, Pittsburg Plate Glass, set up the Radiation Polymer Company which subsequently became an independent low energy accelerator company, RPC Industries. In 1975, Sherman Farrell and colleagues obtained a patent on a segmented, short, parallel-connected filament system for use in a low energy electron beam. This technology was adopted by RPC Industries (now Broadbeam Equipment part of PCT Engineered Systems) and has become a preferred filament configuration in many low energy electron beams. The failure of any single filament does not disrupt the entire beam because the close spacing of adjacent filaments can irradiate the target area with sufficient uniformity [73].

Unable to convince his management at HVEC of the merits of a single-gap low energy (100 to 300 keV) electron accelerator based on an elongated filament, Sam Nablo and a HVEC colleague, Bertram Quintal, formed Energy Sciences Incorporated (ESI) in 1970 to develop and commercialize this low energy, self-shielded electron beam equipment [74, 75]. In the late 1990s, ESI developed a more compact, self-shielded unit that significantly lowered the costs for using low energy EB in surface curing applications [76].

In the 1980s, an in-line low energy EB system for curing paint on automotive components was also developed by Peter Holl and colleagues at Polymer Physik in Germany [77]. These systems used low energy (250 keV), scanned beams [78].

In the 1990s, two industrially significant developments occurred on each end of the electron beam power spectrum. Unable to convince his management at ESI of the merits of a modular system that would overcome the time consuming repair of low-energy EB units in the field, Tovi Avnery formed his own company, Applied Advanced Technologies in 1997 (now known as Advanced Electron Beams - AEB). AEB relies upon in-plant evacuation of the beam chamber as well as compact power supplies and computer controllers [79, 80]. AEB specializes in low cost, modular EB systems in the 80 to 150 keV range of electron energy.

Ion Beam Applications SA (IBA) began its existence in 1986 as a spin-off of the Cyclotron Research Center of the Catholic University of Louvain-la-Neuve in Belgium. In the late 1980s, under the sponsorship of Commissariat à l'Energie Atomique in France, Annick N'Guyen and Jacques Pottier developed a novel accelerator design that could deliver high electron energies, up to the commercially acceptable 10 MeV, which was patented and licensed to IBA [81]. At IBA, Yves Jongen and Michel Abs brought these systems to very high beam currents, with total emitted beam powers of 700 kW having been attained. This design has become known as the Rhodotron™ [82].

Based on fundamental physics developed by Thomson and Rutherford, following Lenard and then Roentgen's discovery of X-rays, there has been a continuum of electron beam accelerator development leading to today's wide array of robust electrical equipment that serves the needs of industry. From Coolidge, through Westendorp, Cockcroft, Walton, Wideröe, Hansen, Varian, Van De Graaff, Trump, Emanuelson, Cleland, Mizusawa, Auslender, Salimov, Svinjin, N'Guyen, Pottier, Abs and Jongen, high-current mid to high-energy electron beams have emerged. Since the 1970s, Coolidge's electron beam concepts have been developed by Nablo, Quintal, Farrell and Avnery in the low energy range. Underscoring commercial and industrial needs has been the requirement for high beam currents. As noted, beam current is directly related to through-put and greater through-put for any industrial operation means enhanced productivity and in turn profitability.

2.2. Industrial Electron Beam Sources

The markets and uses for electron beam sources, rugged pieces of industrial electrical equipment, can be divided into major categories based upon accelerator electron energy. There are three general categories: 1) high-energy units (5.0 to 10 MeV); 2) mid-energy, high-current units (400 keV to 5.0 MeV); and 3) low-energy, self-shielded units (80 to 300 keV). Table II above reflects the end-use market areas of interest for these high-current electron beam sources. As the discussion of the historical development of accelerators points out, a plurality of electrical designs has evolved in each of these areas. Those which have

attained substantial market usage are illustrated in more detail below. Accelerators above 300 keV are all scanned beam systems; those at 300 keV and below are mostly based on elongated filaments or filament arrays and are all self-shielded.

Industry demands three basic requirements from the suppliers of accelerators:

- High beam-current
- Industrial reliability
- Industrial credibility

In contrast to low-current accelerators used in research environments, such as the >550 Van De Graaff generators and short peak pulse, relatively low duty factor linacs, any industrial electron accelerator must be able to deliver substantial beam power (at least 10 kW or much greater, as 100 kW and even up to 700 kW). As noted, beam power is a key factor in any through-put equations. Industrial operations use electron beam processing as they would any other process. Accelerators must be available for on-demand use twenty-four hours a day, seven days a week. One major user of radiation processing (>20 accelerators) has honed its maintenance schedules such that corporate wide its electron beam processing systems are ready for use 99% of the time, probably with a higher reliability than other heavy process equipment. Given the changes in the marketplace, the coming and going of accelerator vendors and their ownership, industrial credibility has become a key factor. Since installations in the high and mid energy range can involve a sizeable capital investment (>\$1,500,000 USD), the credibility of a vendor has become paramount to the success of the entire industry. Some reliable vendors are listed in each energy category.

2.3. High-energy Accelerators

Two types of accelerator design have found industrial acceptance in the high energy area (5.0 to 10 MeV) area: microwave linear accelerators (linacs) based on concepts developed by Wideröe, Hansen and the Varians, and the radiofrequency Rhodotron derived from the development of N'Guyen and Pottier as brought to commercial reality by Abs and Jongen and colleagues at Ion Beam Applications. Because of the extensive use of linacs in research and in medical therapy, a great deal of care must be given to differentiating those linacs that are suitable for industrial use from those used in these other applications. For the most part, industrial linacs are limited to a peak energy of 10 MeV so as not to pose problems of induced radioactivity. Industrial linacs can also be downsized to lower electron energies of a few MeV [83]. Linacs have relatively modest energy conversion efficiency, ~30% of input power to beam output. For industrial purposes high dose-rates and high duty factors are required. The duty factor is the fraction of beam operating time (that is the beam pulse width times its repetition rate) during which the beam is on. Research linacs may operate at low duty factors and also with relatively low dose-rates, in the order of 1 kGy/minute. Low dose-rates, as are also provided by Van De Graaff accelerators, are not common to industrial equipment. Beside product through-put, dose-rate is of consequence in some effects that electron beams have on materials.

Industrial linacs have been produced for decades by GETINGE LINAC, recently known as Linac Technologies, a direct descendent of MeV Industrie S.A. and CGR-MeV, a pioneer in the industrial use of microwave linear accelerators. In 1985, the antecedents of Linac

Technologies helped launch the use of 10 MeV CIRCE™ linacs for food irradiation and, in 1987, for medical device sterilization [84, 85]. This firm has also installed the only industrial accelerator for use in crosslinking the matrix of carbon fiber composites at the European aerospace consortium Aerospatiale's facility in the Bordeaux region of France (1991), where there is a 10 MeV, 2 mA accelerator with part-time X-ray capabilities. Industrial linacs can be positioned vertically or horizontally or use bending magnets to arrange the accelerator and its scanning beam per end-use requirements. Figure 13 is a schematic of a complete linac installation, including its power supply. Figure 14 illustrates that the length of these linear accelerators (linacs) is proportional to the output beam energy. At 10 MeV, industrial linacs can be as long as ~4.3 meters. At beam energies in the low MeV range, relatively short and compact linacs have been used. Figure 15 shows a 10 MeV CIRCE linac installation. Figure 16 shows the Unipolis 10 MeV installation in France that is capable of using both EB and X-rays for curing carbon fiber composites. Filament wound carbon fiber rocket motor housing can be both rotated in front of the beam and travel in a direction across the beam scan for curing. X-ray targets are interposed and the travel speed reduced in order to attain better dose uniformity at the thicker ends of these spheroids.

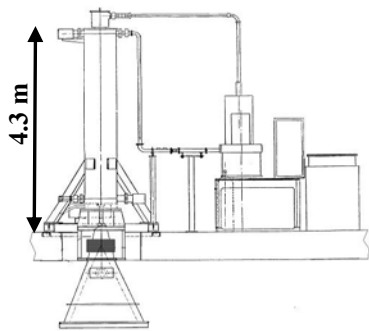

Figure 13. 10 MeV Linac System

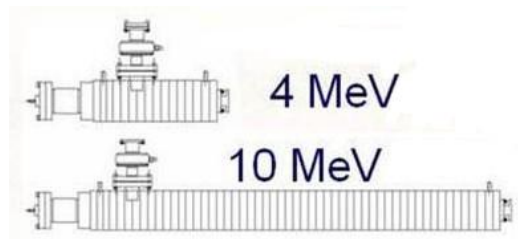

Figure 14. Relative Lengths of Industrial Linacs

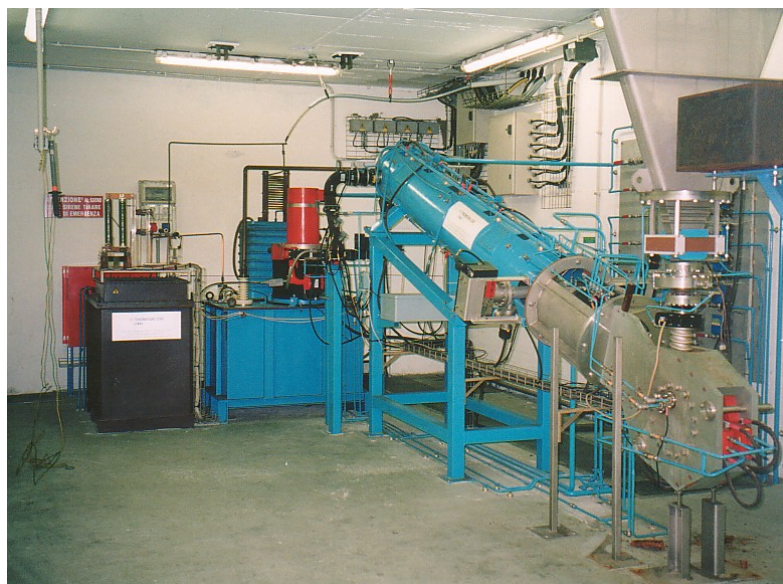

Figure 15. Industrial 10 MeV CIRCE Linac Installation with an Inverted Scan Horn

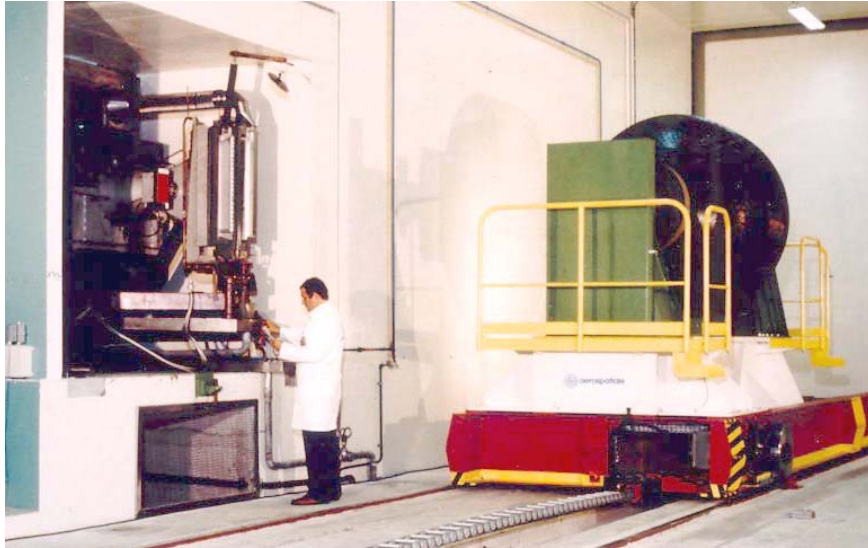

Figure 16. The Unipolis 10 MeV Facility

L3 Communications, along with a license agreement with Varian, which has restricted itself to the medical area, also provides industrial linacs. The Canadian firm, Mevex, entered the commercial linac business after having provided service capabilities for this type of accelerator. Mevex has developed a small diameter, compact, high power (30 kW) linear accelerator which has greater power than most industrial linacs. Figure 17 shows the Mevex unit. The Budker Institute ILU accelerators are resonant cavity accelerators operating at lower frequencies which result in equipment with larger diameters, as shown in Figure 18 [67].



Figure 17. 30 kW 10 MeV Mevex Linac

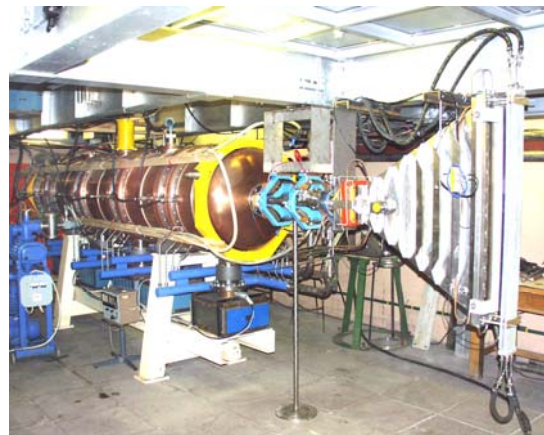

Figure 18. ILU-14 7.0 to 10 MeV Accelerator

Whereas industrially used linacs typically operated with a maximum of 60 kW of total beam power, the Rhodotron has gone up to 700 kW at 7.0 MeV. At such high beam power, the generation of X-rays becomes a viable industrial option for radiation processing [1, 2]. The compact design of the Rhodotron has the capability of having multiple beam lines with different electron energies drawn off the same accelerator (but not concurrently). The Rhodotron operates using bending magnets to accelerate electrons through a “figure eight” pattern. Figure 19 is a sketch of the interior of a Rhodotron. Figure 20 illustrates the basic concept of the Rhodotron in which G is the filament source and D are bending magnets. Figure 21 shows the compactness of a 10 MeV, 200 kW Rhodotron.

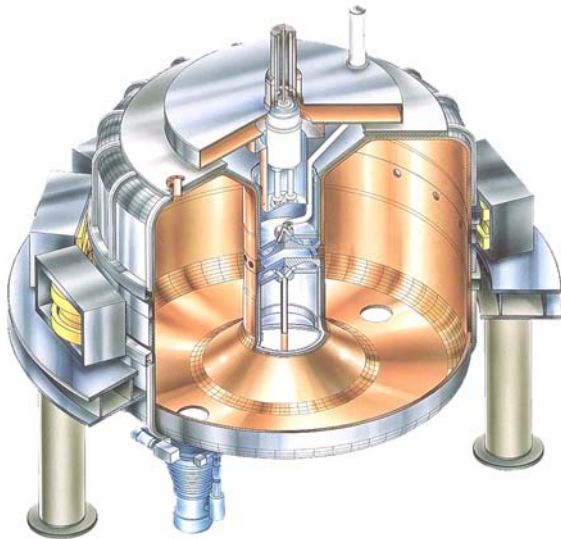

Figure 19. Rhodotron Interior

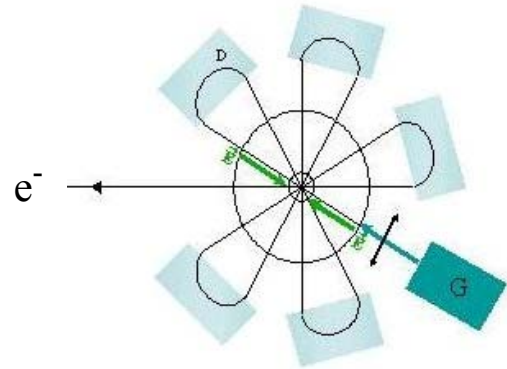

Figure 20. Rhodotron Principle



Figure 21. 10 MeV, 200 kW Rhodotron

Besides the earlier use of linacs to produce X-rays, the Rhodotron too has demonstrated the industrial viability of X-ray processing. The US Postal Service has been using a 130 kW Rhodotron installed in a facility in New Jersey to sanitize mail for critical US Federal government departments and agencies. A 10 MeV electron beam line has been used with trays of mail and a 5.0 MeV line with a tantalum X-ray target has been treating bulk mail in sacks. Figures 22 and 23 illustrate the versatility of the Rhodotron, with one beam line being bent downward to a lower vault for electron beam processing and two other beam lines directed horizontally toward X-ray targets. Only one beam line can be operating at any given time.



Figure 22. 10 MeV EB Facility

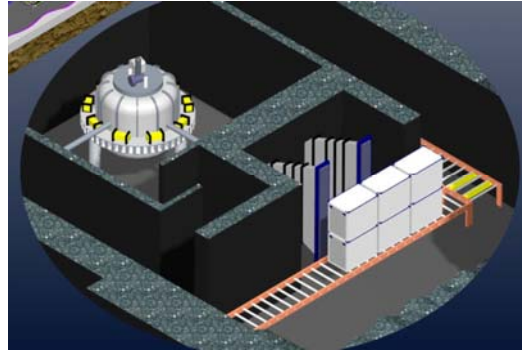

Figure 23. 5.0 and 7.0 MeV X-ray Facility

X-ray processing for medical device sterilization and for food irradiation has been accepted by international regulatory agencies and in the US, including the use of X-rays generated from a 7.0 MeV electron beam for food irradiation. Figure 24 shows totes that are capable of holding food products, such as cartons of ground beef, or boxes of medical disposables ready to be conveyed before 2 meter tall, water-cooled, tantalum X-ray targets.



Figure 24. Totes Ready for X-ray Processing

In the area of linac technology, one must be very careful to distinguish between research linacs and those that are suitable for industrial processing. A significant many-year investment in linear accelerator systems by a reputable firm, Atomic Energy of Canada Limited (AECL), with its development of the Impela™, a 10 MeV, 60 kW accelerator, did not achieve substantive market acceptance. Some firms that specialize in research or medical equipment have not gone into the industrial market. For example, the Varian Corporation, an outstanding manufacturer of medical therapy electron beams and of X-ray equipment, also disbanded its efforts in the industrial area. The companies that have exhibited experience in serving the industrial market with high electron energy accelerators are listed below along with Ion Beam

Applications, the manufacturer of the Rhodotron, a unique patented design of a high energy electron beam accelerator.

Industrial linear accelerators (linacs):

- GETINGE LINAC (formerly Linac Technologies)
(www.linactechnologies.com)
- Budker Institute of Nuclear Physics (www.inp.nsk.su)
- L-3 Communications Pulse Sciences (formerly Titan Scan)
(www.titan-psd.com/TitanScan/index.html)
- Mevex (www.mevex.com)
- EB-Tech (www.eb-tech.com)
in cooperation with the Budker Institute of Nuclear Physics

The Rhodotron:

- Ion Beam Applications SA (www.iba.be/industrial/index.php)

2.4. Mid-energy Accelerators

Mid-energy electron accelerators produce scanned beams that range in energy from 400 keV to 5 MeV. The units that are suitable for industrial use are all characterized by being able to provide high beam currents, many tens of milliamps. These high beam currents provide high dose-rates that are needed for industrial production. Research equipment in the same mid-energy range, such as Van De Graaff generators (>550 units) or Pelletrons™ (an electrostatic device using insulated chains instead of belts to build up charge; >150 units) do not attain these high-current and high dose-rates. Five electrical design systems have been used to attain mid-energy and high beam current: 1) the Cockcroft-Walton and its enhancements by Nissin-High Voltage (developed by Mizusawa and associates), 2) the Insulated Core Transformer (developed by Van De Graaff, Trump and Emanuelson and enhanced by M. Letournel), 3) the Dynamitron (developed by Cleland and associates at RDI), 4) a magnetic coupled dc system (the ELV systems developed by Salimov at the Budker Institute), and 5) high-current pulsed beams (the ILU radiofrequency systems developed by Auslender and associates). The Dynamitron can attain very high beam currents (60 mA) at up to 5.0 MeV (300 kW). The ICT and ELV mid-energy accelerator designs are limited in electron energy to 2.5 MeV. Figure 25 is a rendition of a 5 MeV, 300 kW IBA Industrial Dynamitron; Figure 26 of a 2 MeV, 100 kW ELV-8 EB accelerator. Figure 27 shows a 3.0 to 5.0 MeV, 50 kW ILU-10 accelerator that does not require a pressure vessel since it does not use sulfur-hexafluoride as an insulating gas. The Nissin-High Voltage enhanced Cockcroft-Walton can attain 150 kW at 5.0 MeV and can be used for X-ray conversion [86, 87]. These high-current, mid-voltage EB units are the accelerators used in the dominant market areas of wire and cable, heat-shrinkable tubing and in the tire industry where EB processing is a routine and well accepted industrial manufacturing practice. Interests in the wire and tubing areas has lead to the development of IBA Industrial's Easy-e-Beam™ high current, self-shielded 800 keV, 100 mA turn-key system, as shown in Figure 28.

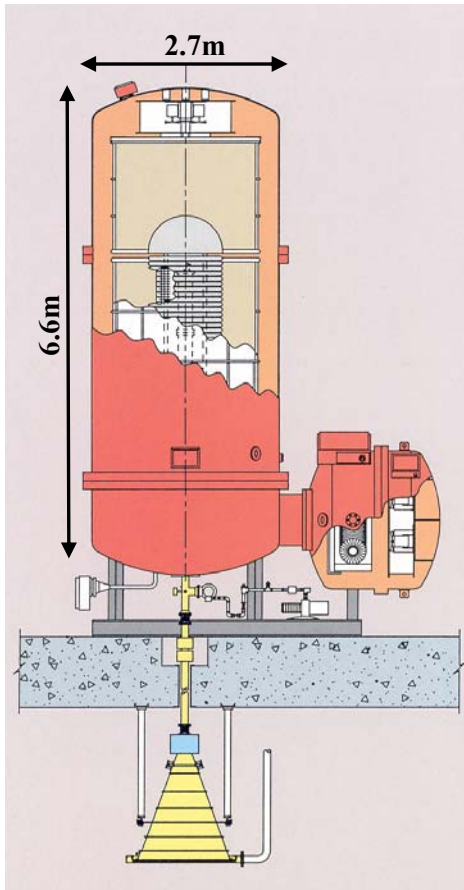

Figure 25. 5.0 MeV, 300 kW Dynamitron

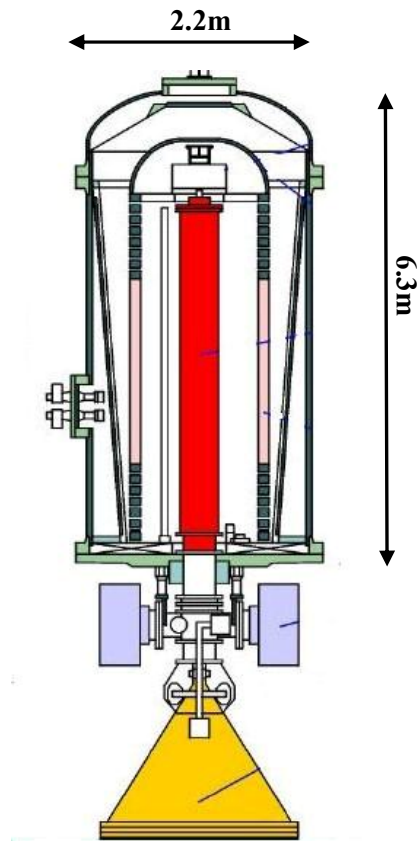

Figure 26. 2.0 MeV, 100 kW ELV



Figure 27. 3.0 to 5.0 MeV ILU-10



Figure 28. Easy-e-Beam 800 keV, 100 mA

One property of medium and low-voltage DC accelerators is the ability to provide multiple-beam systems by using cable connections or gas insulated transmission lines from one power supply. Flexible cable connections are limited to 800 keV, with gas transmission systems going to 2 MeV. Figure 29 shows a double beam, cross-firing arrangement from a single 2 MeV, 80 mA ICT power supply to two 40 mA beams used in a multi-pass crosslinking process to reduce the electron beam energy and to enhance dose distribution [88].



Figure 29. Vivirad 2 MeV with Two Cross-firing Beams from One Power Supply

As with high-energy linear accelerators, one must be cautious about the distinction between accelerators which have industrial capabilities and those intended for research purposes. Besides the Van De Graaff and Pelletron systems, a few other low-current mid-energy electron accelerators have been developed. These are limited to research functions and would not attain the through-put or dose-rates required by industry. The companies that have experience in providing industry with mid-energy, high-current electron accelerators are:

- IBA Industrial, Incorporated (formerly Radiation Dynamics, Incorporated) (www.iba-worldwide.com/industrial)
- NHV Corporation (www.nhv.jp/en/index.html)
- Budker Institute of Nuclear Physics (www.inp.nsk.su) marketed through EB Tech, Limited (www.eb-tech.com)
- D. V. Efremov Scientific Research Institute of Electrophysical Apparatus (NIIEFA)
- Vivirad SA (formerly Vivirad-High Voltage Corporation) (www.vivirad.com)
- Wasik Associates (www.wasik.com)

2.5. Low-energy Accelerators

Over the past decade or more, the fastest growing market for industrial accelerators has been in the low-energy area. Applications include the curing or crosslinking of inks, coatings and adhesives that are based upon liquid reactive materials that do not contain solvents. A driving factor has been the need to limit the air pollutants emitted from industrial operations. Those who have adopted low-energy EB processing have found that the overall energy efficiency of these radiation processes far exceeds other methods, such as forced air drying (see Table I). Low-energy accelerators are sufficiently low in voltage such that they can be shielded with high density metal, most commonly lead, but more recently just steel. At the upper end of the low-energy systems are 500 keV scanned ICT accelerators that are used to crosslink films for food packaging with one end-user having >125 such EB units. At 300 keV and below, equipment with long linear filaments, as show in Figure 30, can be used. These units take up little plant floor space and can be fitted into coating and conversion process

lines. The Energy Sciences Incorporated Electrocurtain™, developed by Quintal and Nablo, has used this approach. Figure 31 shows the accelerator, but not its power supply, which itself takes up only slightly more than one cubic meter.

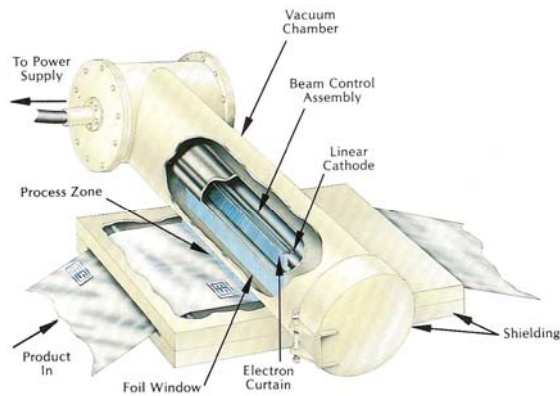

Figure 30. Low-energy EB Design

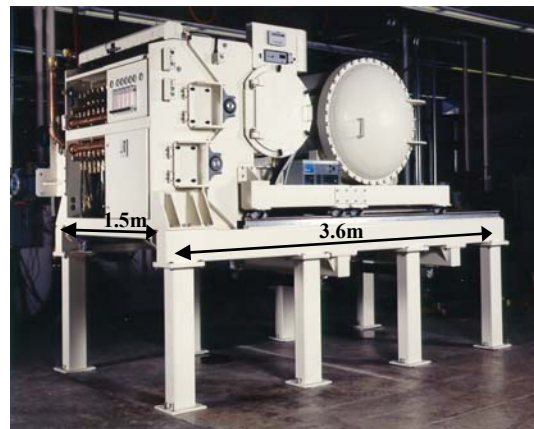

Figure 31. Low-energy EB unit

An alternative system to a long linear cathode is a segmented cathode which links short filament segments in parallel, as developed by Sherman Farrell. When a linear filament burns out, the entire electron beam chamber has to be opened and the filament replaced. With a segmented filament, should a single filament burn out, the adjacent filaments can still provide adequate surface exposure so that production continues without disruption. The segmented filament is used in 100 to 300 keV self-shielded equipment. Figure 32 shows this filament array without the titanium beam window in place. Broadbeam™ Equipment, part of PCT Engineered Systems, now produces the equipment that was developed by RPC Industries. The segmented filament concept is also used by the NHV Corporation (Nissin High-Voltage) in its Curetron™, its low-energy accelerator, Figure 33.



Figure 32. Segmented Low-energy EB Filament Array without Beam Window

Almost all low-energy electron beam accelerators are fitted into printing, coating or similar continuous web-based processes. In relation to other process equipment, such as a printing press, a coating system and drying ovens, the EB unit takes up a very modest amount of total process line space. As depicted in Figure 30, a moving web enters and exits the under beam area on an angle so as to minimize the length of shielding required. However, a low-energy EB unit can also be arranged for treating flat materials, as shown in Figure 33.



Figure 33. 300 keV, 100 mA NHV Curetron for Surface Curing on Flat Substrates

Energy Sciences, Incorporated (ESI) has downsized its low-energy equipment to make it more compact and less costly. ESI has developed a fixed low-voltage EZ-Cure™ system which is about half the size of its more historic units, as shown in Figure 34. PCT Engineered Systems has produced the downsized LE Broadbeam series of equipment, Figure 35.



Figure 34. ESI EZ-CURE III



Figure 35. Broadbeam LE Series

Another approach to less costly low-energy electron accelerators has been developed by Tovi Avnery and commercialized by Advanced Electron Beams (AEB). AEB has shifted the paradigm of accelerator manufacture. Whereas most accelerators are made to order, AEB produces two standard designs (a beam with a 26 cm long window; and a smaller diameter unit with a 41 cm long side window). Unlike all other accelerators, the AEB units are evacuated at the factory and designed for a plug-and-use operation. Figure 36 shows a two-module AEB unit open; Figure 37 with the shielding closed. Figure 38 is a schematic of the module design of the AEB system and its operating principles. Of significance to the entire EB processing industry is AEB's development of a low-cost, all-in-one, self-shielded laboratory unit, the Applications Development Unit which occupies less than two square meters of floor space, Figure 39. This low cost unit (<\$200,000 USD) operates at 80 to 120 keV and enables research on materials of sufficiently low gauge thickness, such as thin films

and liquids for inks, coatings or composite matrices, and even gases, to be conducted within any laboratory at meaningful beam currents for industrial processes [89, 90].



Figure 36. 50cm Two Module Unit

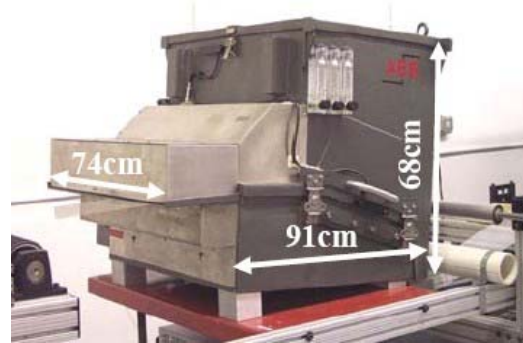

Figure 37. 50cm Two Module Unit Shielded

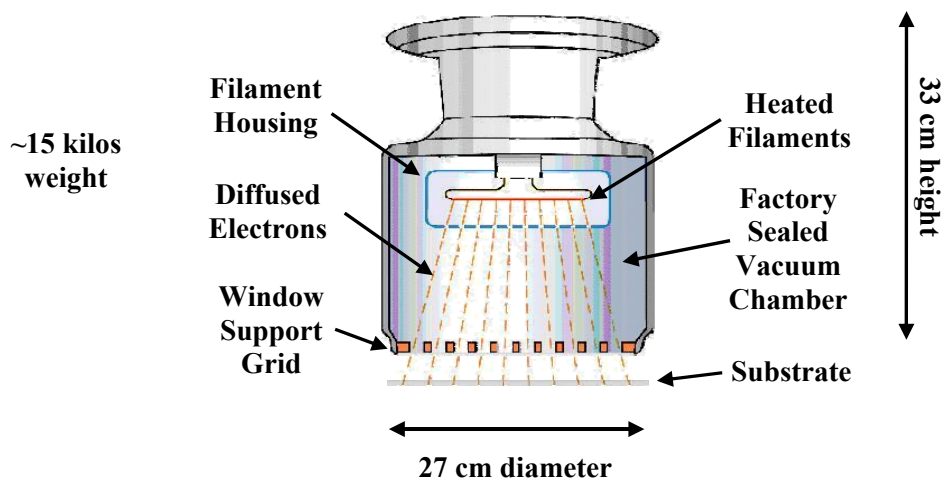

Figure 38. Low-energy Modular EB

In the low-energy electron beam area, the major end-user of 500 keV self-shielded systems, the Cryovac division of the Sealed Air Corporation produces its own accelerators, having acquired the designs for such from its former supplier, the High Voltage Engineering Company, when HVEC went out of the accelerator business. The companies that supply self-shielded, high-current low-energy accelerators (≤ 300 keV) are:

- Energy Sciences Incorporated (www.ebeam.com)
- Broadbeam Equipment (www.broadbeamequipment.com/home.shtml)
- NHV Corporation (www.nhv.jp/en/index.html)
- Advanced Electron Beams (www.advancedelectronbeams.com)

Fourteen different business entities offer industrially reliable high-current electron beam accelerators ranging in beam energies from 80 keV to 10 MeV. Each of these has established market credibility using a variety of different accelerator designs. The referenced patent literature illustrates the diverse ways in which high-current electron beam accelerators can be designed. Given this diversity of equipment, greater emphasis is needed in developing end-use applications. While not endorsing any particular accelerator system, this diverse array of electrical equipment can cover many known and emerging applications. As emphasized above, care should be taken to distinguish industrial equipment from research electron beams,

which do not offer the power or the average dose-rates of industrial equipment. To have commercial significance, any experimental work conducted using such research equipment should be validated using industrial accelerators [91].



Figure 39. Self-shielded Low-energy Applications Development Unit

2.5.1. Low-energy EB Compared to Ultraviolet (UV) Radiation

An alternative process to low-energy EB for the curing of inks, coatings and adhesives, that also uses liquid applied materials with near-zero volatile organic compounds (VOCs), is ultraviolet (UV) radiation. UV sources tend to have peaked emissions, as between 240 and 270 nm and between 350 and 380 nm for mercury vapor sources. Metal dopants are used to shift the spectral output and interests have emerged in using light to initiate cure. Significantly less capital is required to enter into the manufacture of UV equipment and equipment costs are considerably lower than for low-energy EB systems. As a result, there is a greater diversity of UV equipment suppliers and of UV process installations. However, as illustrated in Figure 40, UV is limited to surface treatment whereas EB penetrates through materials such that even very opaque coatings can be easily cured with EB. Since UV itself is too low in energy to initiate reactions, photoinitiators must be used in UV curable formulations. These specialty materials can add at least 10% to the cost of a formulation and their absorption must be matched to a given UV source. These complex photochemical reactions can be ~10 times slower than those initiated with EB. EB processes are more widely accepted where high volume, high speed production is required [92].

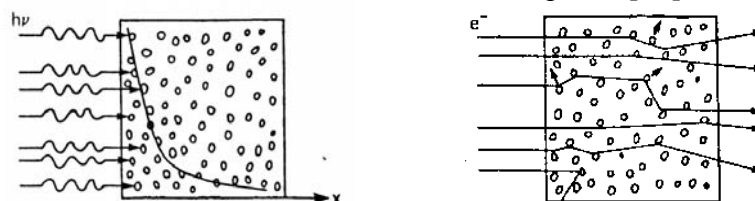

Figure 40. UV versus EB Penetration

3. MATERIAL EFFECTS

Industrial electron beam radiation processing is based on a solid foundation of fundamental work done on polymers and polymeric precursors, some dating back to the late 1950s and early 1960s. Arthur Charlesby in the United Kingdom [93], Adolphe Chapiro in France [94], Malcolm Dole [95], Vivian Stannett and Joseph Silverman [96] in the United States, Sueo Machi and Yoneho Tabata [97] in Japan, John Spinks and Robert Woods in the United Kingdom [98], and Alexei Pikaev in Russia [99], all pioneered the basic understanding of how this form of energy transfer affects materials.

Carbon based materials that are monomers, oligomers or polymers are used in industrial radiation processing. In dealing with polymers, the predominant chemical reaction of interest is the hemolytic cleavage of carbon-hydrogen bonds to form free radicals, leaving atoms along a molecular chain with an unpaired electron. The formation of a carbon free radical is illustrated in Figure 41 which shows a carbon atom having six orbiting electrons picking up an additional electron. Free radicals can be either neutral or charged. The unpairing of electrons to form radicals can also result from electron removal. Carbon-halide and carbon-methide hemolytic bond cleavage are also of industrial importance. The free radical opening of vinyl double bonds in elastomers is of significance in the crosslinking of tire components [100, 101]. The opening of terminal double bonds on monomers and oligomers is of importance in the crosslinking of polymeric precursors of materials used in inks, coatings and adhesives [12, 71]. These free radical reactions are initiated by direct impingement of a material by radiation, be it in the form of accelerated electrons or the slightly less energetic X-rays. Such direct impingement of radiation on materials contrasts sharply with widely known and industrially used forms of energy transfer as convection heating and the use of thermo-chemical reactions, most of which require catalytic initiation. As pointed out, thermo-chemical systems are grossly inefficient in terms of energy transfer in comparison to radiation processes [102, 103].

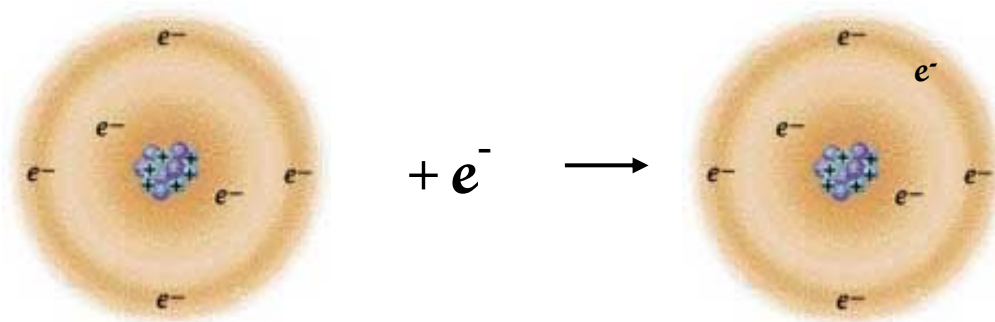

Figure 41. Carbon Atom with Electron Added to Yield a Free Radical

In some polymers, the formation of free radicals can alternately lead to scissioning or the breaking of the carbon based polymer chain. Controlling the scissioning of carbon polymers is of interest in some application areas. Of significant interest is the breaking of the double strand of deoxyribonucleic acid (DNA) in the sterilization and food decontamination processes [104, 105].

Another basic chemical response to radiation of industrial consequence is the trapping of energy from electrons or X-rays by cyclic ring structures such that the absorbed energy resonates within the carbon ring itself. Polymers based on ring structures, such as polystyrene

(PS), polycarbonate (PC), and polyethylene terephthalate or polybutylene terephthalate (PET or PBT) are known for their radiation resistance, being able to be exposed to thousands of kGy with little effect on the material's mechanical properties.

Color-body formation is another chemical response to radiation of industrial interest. This mostly pertains to the use of plastics exposed to radiation in sterilization processes. Medical devices themselves and their blister packaging materials have to remain as near colorless as possible. Polyvinyl chloride (PVC) materials when exposed to radiation in the sterilization process should not turn dark brown. It is generally held that color-bodies are formed by non-carbon materials, obviously the halide excitation in PVC, but also residuals in materials such as PC and PET. A material such as polysulfone (PSU), with its abundant internal sulfur linkages, has little chance of retaining its transparency and water-white color upon exposure to any form of radiation, becoming dark brown under exposures required for sterilization.

Most polymers that have wide commercial acceptance in radiation processing are addition polymers. While research has been done with condensation polymers, such as polyurethanes and polyamides (nylons), these require special formulating approaches to render them radiation responsive. Even when astutely formulated, these condensation polymers have not shown enough enhancement to warrant commercial merit after exposure to radiation.

Cationic reactions have shown minor commercial interest in the radiation processing industry. These result from heterolytic bond cleavages that are generated from the dissociation of highly specialized initiation catalysts with this chemistry. With EB and X-ray initiation, only one initiation catalyst has been found to be effective, a sole-sourced iodonium salt [106]. Cationic chemistry has been explored in the coatings industry and for use with matrix materials in prototype electron beam cured carbon fiber composites. The main advantage of this chemistry is that it is not inhibited by the presence of oxygen so that crosslinking can take place in air, not being perturbed by oxygen inhibition, a special concern in the coatings area. The catalysts used in this chemistry can be costly and have been found to lack long-term shelf-stability when used in formulated products. Cationic reactions are also sensitive to humidity and often require some thermal post-cure in order to go to completion [12, 71].

Many polymer properties are of interest. The demands of a given application spell out a specific set of properties which in turn dictate the choice of polymer type and within a given type a specific grade. In general, one should be aware of molecular weight (weight average = M_w ; number average = M_n), molecular weight distribution (M_w/M_n), and molecular weight between crosslinks (M_c). Molecular weight and molecular weight distribution influence how easily a high molecular weight polymer, either a thermoplastic or an elastomer, will process using melt processing equipment, such as extruders, molding presses and so forth. M_w is close to the viscosity average molecular weight, which for thermoplastics governs the melt flow of the material [12]. For elastomers, low M_w also indicates ease of processing prior to crosslinking. Measurements for bulk melt or elevated temperature flow properties rely on different tests for different types of materials. For example, melt index (MI) is used for polyethylenes and melt flow rate (MFR) is used for polypropylenes; the lower the molecular weight, the higher the MI or MFR, when tested per ASTM D-1238, "Standard Test Method for Melt Flow Rates of Thermoplastics by Extrusion Plastometer" [107]. For polycarbonates, ASTM D-3935 "Standard Specification for Polycarbonate (PC) Unfilled and Reinforced

Material” is appropriate. For PET, intrinsic viscosity in solution is used, per ASTM D-4603 “Standard Test Method for Determining Inherent Viscosity of Poly (Ethylene Terephthalate) (PET) by Glass Capillary Viscometer” [108]. For elastomers, the Mooney viscosity is most commonly used, ASTM D-1646 “Standard Test Methods for Rubber—Viscosity, Stress Relaxation, and Pre-Vulcanization Characteristics (Mooney Viscometer)” [109]. Higher Mooney units indicate higher molecular weight for an elastomer. Vendor specifications include such industry recognized indicators of M_w . Reputable vendors will also be able to provide an indication of molecular weight distribution (MWD). All of these factors are very grade specific and can differ from vendor to vendor and within vendor product grade slates. There are no generic materials in any category, but a plurality of grades.

In looking at the various markets served by industrial electron beam processing (Figure 1), the dominant use of this process technology is to crosslink a material, be it a thermoplastic as polyethylene, an elastomer as used in tire components or a polymeric precursor as used in inks, coatings and adhesives. Crosslinking is the formation of a three-dimensional polymer network (ASTM D-883, “Standard Definitions of Terms Relating to Plastics) [107]. Such networks are insoluble, forming a gel in solvents. The linking of molecules without gel formation is considered to be chain extension which results in increases in molecular weight (M_w) and shifts in molecular weight distribution (MWD). While the morphology or structure of any given material governs many mechanical properties and physical attributes of a crosslinked product, in many applications it is important to understand the significance of the crosslinked density, which reflects the molecular weight between crosslinks, M_c , as illustrated in Figure 42 [12].

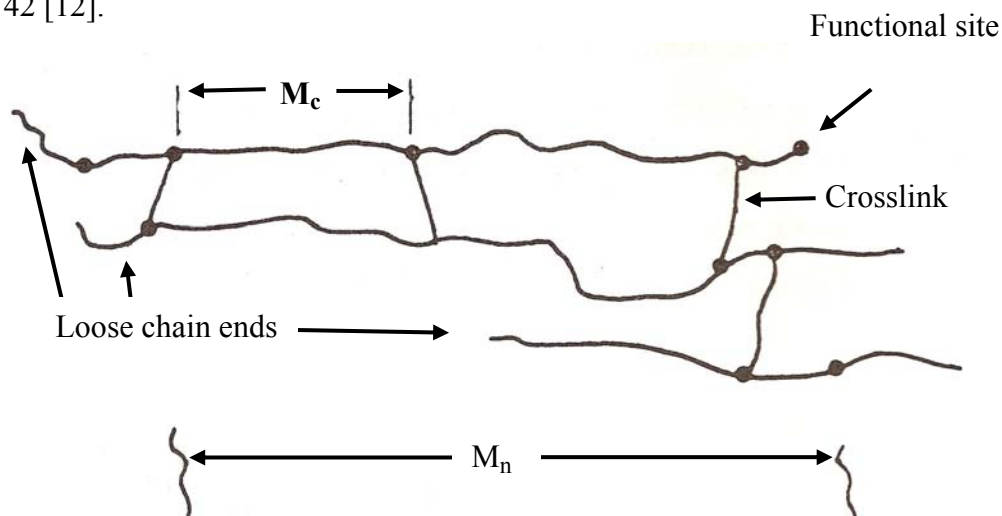

Figure 42. Illustration of M_c in Crosslinked Materials

In using radiation processing in the production of grafted polyethylene films for battery separators, a very high crosslinked density is desired to control ion flow. In tire manufacture, low crosslinked density and modest gel content (~30 to 60%) is desired in order to permit the tire components to knit or flow together in subsequent molding operations which rely upon thermal curing. In heat-shrinkable products, films or tubings, M_c governs the elastic recovery force when a crosslinked product is taken above its melt transition to shrink around an object. In coatings, controlled M_c is needed in order to balance surface hardness and impact

resistance. In pressure sensitive adhesives (PSAs) that are crosslinked using electron beams, a controlled M_c is needed to balance tack and hold properties.

In subjecting any polymer to electron beams or X-rays, the amount of energy input and multitude of hemolytic bond cleavages can result in either polymer chain extension and then crosslinking or polymer breakdown and scissioning. Radiation chemistry has adopted a symbolism to categorize the relative tendencies for polymers to respond in either direction, G_x for crosslinking and G_s for scissioning [110, 111]. The G factor is defined as the event yield in a material for every 100 electron volts absorbed. The Systeme International (SI) unit for G is expressed in micro-mols per joule of absorbed energy, $\mu\text{mol}/\text{J}$. In radiation exposures of polymers and polymeric precursors, there are competing crosslinking (G_x) and scissioning (G_s) events. The preponderance of one over the other indicates what will happen with a given polymer. For polymers that crosslink, one can calculate G_x from the gel point, a point at which a polymer becomes insoluble. Knowing the average molecular weight of a polymer (M_w) and its “dose” at gel (d_g), one can determine G_{gel} and thus arrive at comparative G_x values for various polymers. The dose at gel (d_g) can be determined experimentally through a series of solubility tests using incremental increases in exposure or “dose,” as illustrated in Figure 43. For some polymers, as very high melt index polyethylenes (low molecular weight), the competing crosslinking and scissioning events cancel each other out so that no effect is observed. For polymers with ring structures in which the absorbed radiation is believed to resonate within the carbon ring, the G_x and G_s values are very low, at the order of 10^{-2} .

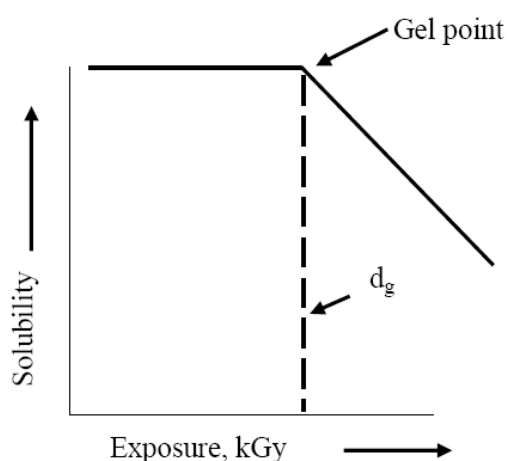

Figure 43. Illustration of the Determination of G_{gel}

The G_x and G_s values for many polymers that have relevance in industry have been compiled in many publications. Care should be taken to note the specific conditions under which such determinations have been made. At best the G_x and G_s values indicate a relative response and tendency, not a precise numerical value.

While this information helps understand underlying radiation chemistry, most industrial uses, not governed by regulatory regimes, as are device sterilization and food irradiation, rely upon industry specific end-use product tests. Inks and coatings are subjected to solvent rubs per ASTM D-5402 to determine cure or the effects of radiation processing on them [112]. Partially EB cured rubbers are evaluated in the tire industry by measuring the modulus increase per ASTM D-412 [109]. Radiation crosslinked thermoplastics, such as those used in wire and cable jacketing and for heat-shrinkable tubing and films, are evaluated for their

modulus above the melt transitions of the thermoplastic as per ASTM D-638 and D-882 [107]. “Dose” or surface “dose,” if it is used at all, is at most a communication or linguistic device to enable vendors and users to communicate their respective experimental results and not necessarily a process control tool. It should be borne in mind that the unit for dose, the kGy, is equal to 1 joule/gram = 0.24 calories/gram = 0.24 °C rise in the temperature of water per kGy. Corrections for heat rise based on the heat capacities of different materials should be made. Table V lists the temperature rise expected in common plastics and metals per kGy [19]. A rise of 10 °C doubles the reaction rates. So some thermal side-effects can even lower the dose needed to affect a material. Also, care must be taken to avoid over-heating of metals, which have low heat capacities.

Table V. Temperature Rise of Materials Due to Irradiation

Material	ΔT in °C/kGy
Water	0.24 °C
Polyethylene	0.43 °C
Polypropylene	0.52 °C
Polyvinylchloride	0.75 °C
Aluminum	1.11 °C
Copper	2.63 °C

The three fundamental responses of polymeric materials to electron beam or X-radiation are:

- Crosslinking – the formation of an insoluble material
- Scissioning – the lowering of the molecular weight of a material
- Neutral – little to no effects on mechanical properties

3.1. Polyethylenes

If it were not for the fact that Malcolm Dole [113] and then Arthur Charlesby [114] observed that polyethylene crosslinked when exposed to radiation, there may not be an irradiation processing industry. This coupled the use of radiation processing with what has become the world’s most inexpensive commodity polymer. There are four major market end-uses that rely upon the radiation processing of polyethylenes (PE): 1) wire and cable insulation, 2) heat-shrinkable tubing and wraps, 3) heat-shrinkable food packaging films, and 4) controlled density closed-cell foams. More than half of all of the industrial electron beam accelerators (Figure 1) are used in crosslinking polyethylene.

The radiation responses of various polyethylene types have been characterized by major users and some suppliers. In general, G_x is ~1 and $G_s < 0.1$ [111]. High density polyethylene (HDPE) with its higher crystallinity requires fewer crosslinks for property enhancement and thus often less EB exposure than lower density polyethylenes. Linear low density (LLDPE) polyethylenes with a broad molecular weight distribution (MWD) have been reported to have

better response to radiation than the more common narrow MWD LLDPEs. The relatively new metallocene catalyzed polyethylenes (mPE) respond positively to radiation and crosslink well. The influence of comonomer type and content also affects the relative exposure needed for crosslinking. Copolymers with acrylate comonomers (methyl or ethyl, EMA or EEA) respond better than more common vinyl acetate comonomers (EVA) at the same comonomer content [115]. Since comonomer content detracts from some of the desirable properties of polyethylenes, such as resistance to moisture vapor (ASTM F-1249 “Standard Test Method for Water Vapor Transmission Rate Through Plastic Film and Sheeting Using a Modulated Infrared Sensor” MVTR) [116] and good dielectric properties (Figure 44), it will be interesting to see if blends with mPEs with their outstanding optical clarity and non-polar comonomers can replace more traditionally used copolymers. Blends with mPE will effectively lower combined melt transitions, but not detract from moisture barrier or dielectric properties. They can also impart the suppleness and impact resistance traditionally found with copolymers.

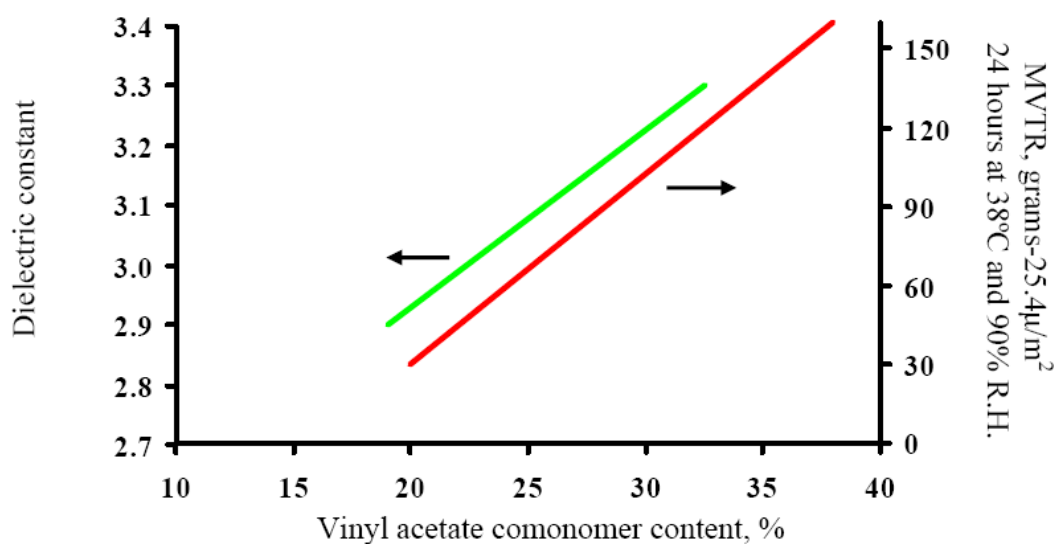

Figure 44. Effect of Comonomer Content on PE Properties

The ethylene copolymer made with vinyl alcohol, ethylene vinyl alcohol (EVOH), responds positively to radiation and is the preferred gas barrier inter-layer in food packaging films that are radiation crosslinked to make heat shrink films or as films for pre-packaged foods that will be irradiated. Ultra-high molecular weight polyethylenes (UHMWPE) respond positively to electron beam radiation. Some concerns over surface oxidation may be related to dose-rate effects during sterilization processes, wherein gamma-ray radiation has a significantly lower dose-rate than electron beam processing and, as a result, material is allowed to be in an ozone rich environment for a longer period of time.

PE crosslinking, that is the formation of a three-dimensional insoluble polymer network, proceeds via the abstraction of a hydrogen atom from the saturated PE backbone. The free radical left on the carbon chain then finds another free radical site on an adjacent carbon on another molecule to form a crosslink, with the abstracted hydrogen combining with another abstracted hydrogen to form a gaseous, readily diffused by-product, molecular hydrogen (H₂). In all cases, specific grade responses to radiation must be studied to make value judgments as to the suitability of any grade for a given application [100, 111]. Figure 45 illustrates this

basic PE crosslinking reaction – the fundamental radiation reaction upon which many industrial applications are based.

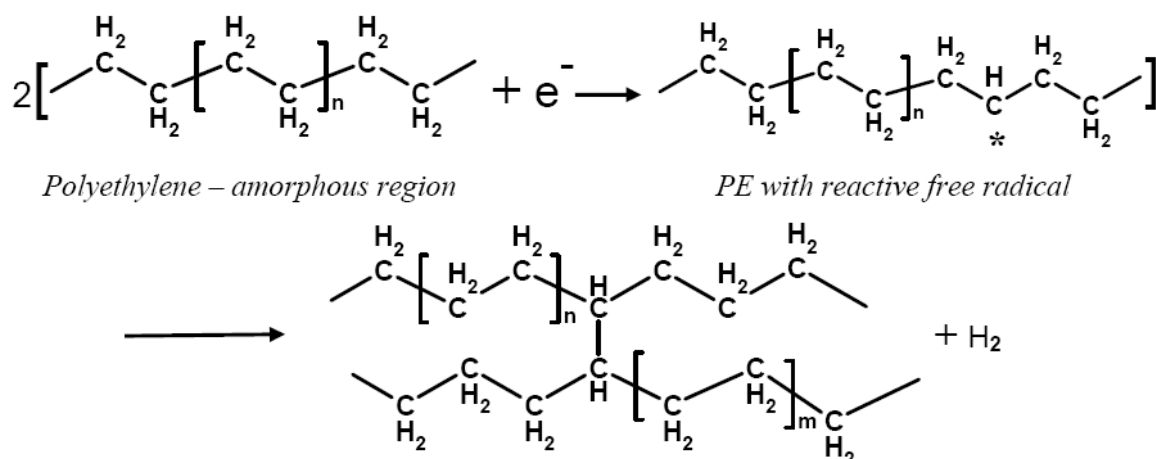

Figure 45. Crosslinking of Polyethylene

3.2. Polypropylenes

Polypropylene (PP) is used in medical device manufacture because of its stiffness and greater resistance to thermal distortion (T_d) than that of even the highest density (0.965) HDPE, $\sim 20^\circ\text{C}$ greater in standard heat deflection temperature tests, such as ASTM D-648 [107]. However, when exposed to radiation, polypropylenes are known to chain scission [117]. This issue, which is aggravated by the presence of oxygen, has been successfully overcome [118]. A long-lived trapped methide radical, CH_3^* , was identified as the source of continued polymer degradation. Stabilizer systems were developed that quenched this long-lived radical and inhibited oxidative degradation as well. These systems enabled medical products, such as syringes, to be sterilized using radiation processing, notably electron beam sterilization.

The recently developed metallocene polypropylenes (mPP) exhibit the same degradation responses as more crystalline polypropylenes. The suppleness of the mPP resins indicates they may be more suited for packaging films than for device manufacture. Depending upon the test protocol one uses to evaluate radiation stability, the very low modulus of mPP can confuse the interpretation of results. Because of their excellent optical clarity, mPP as well as mPE have been proposed for use in blends with polypropylene (PP) as an alternative to plasticized polyvinyl chloride (PVC) [119].

The problem overcome by astute formulation was that upon exposure to ionizing radiation, polypropylene formed a methide radical which remained trapped within the crystalline domains of the polymer. Over time this trapped radical, especially if combined with oxygen, would propagate chain scissioning and an embrittlement of the base polypropylene grade. Figure 46 depicts this scissioning reaction.

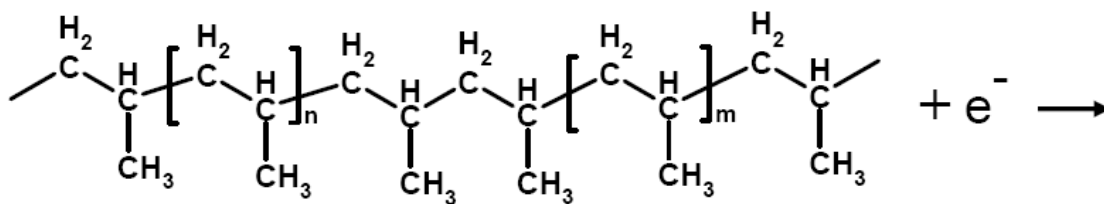

Isotactic Polypropylene

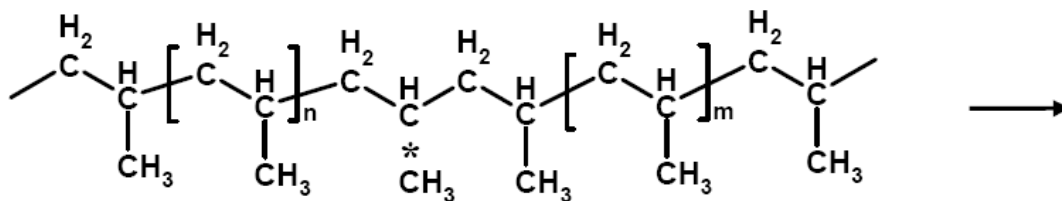

Isotactic Polypropylene with Trapped Methide Radical

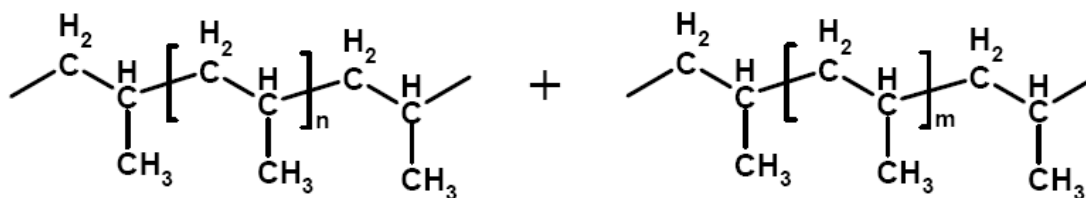

Lower Molecular Weight PP Segments

Figure 46. Chain Scissioning of Polypropylene

Properly formulated polypropylene copolymers, impact grades made by adding a small amount of ethylene, have been shown to crosslink upon exposure to an electron beam. This permits the use of polypropylene in market areas such as wire and cable jacketing and closed cell foam. The key is the use of multifunctional monomers, such as trimethylol propane triacrylate (TMPTA) or triallyl cyanurate (TAC), to shift the kinetics of the free radical reaction from scissioning to crosslinking [120]. These same additives are also known to accelerate the radiation response of polyethylenes. Recent studies have shown that properly formulated radiation tolerant polypropylene exhibits almost the same response, lack of embrittlement, when exposed to X-rays as it does when exposed to electron beams at a prescribed sterilization dose of 25 kGy, but suffers greater degradation when exposed to comparable doses of low dose-rate gamma-ray radiation [121]. Table VI summarizes these results.

Table VI. Radiation Tolerant Formulated Polypropylene Copolymer

Source	Dose	Dose-rate	Elongation	Response
Control	None	----	100%	----
Gamma	25 kGy	2.8×10^{-3} kGy/s	30%	Scissioned
Gamma	50 kGy	2.8×10^{-3} kGy/s	2%	Scissioned
X-ray	25 kGy	3.3×10^{-2} kGy/s	420%	Crosslinked
X-ray	50 kGy	3.3×10^{-2} kGy/s	20%	Scissioned
EB	25 kGy	100 kGy/s	410%	Crosslinked
EB	50 kGy	100 kGy/s	500%	Crosslinked

3.3. Halogenated Plastics: Polyvinyl and Polyvinylidene Chloride, Fluoropolymers

Polyvinyl chloride (PVC) is used in wire and cable jacketing because of the inherent flame retardancy of this halogenated polymer and its relatively low cost. PVC itself will degrade when exposed to radiation. However, it has long been known that multifunctional monomeric additives will reverse this chain scission and enable PVC to be crosslinked using electron beams. In the medical device area, there is a concern over the discoloration of PVC materials, such as tubing, bags and other low cost medical supply items, when exposed to radiation sterilization. This issue has been overcome by the astute use of additives [122]. A division of a basic producer has demonstrated radiation tolerance of its PVC compounds without their darkening or notably changing color upon exposure required for sterilization. Without proper formulating, PVC will chain scission upon exposure to ionizing radiation and yield corrosive decomposition products.

Another chlorinated thermoplastic material, polyvinylidene chloride (PVdC) not only severely discolors but also chain scissions upon exposure to electron beam or gamma-ray radiation. Although PVdC is known for its gas barrier properties, as in the commercial film Saran WrapTM, this polymer should not be used as an inner-layer in irradiated food packaging films.

In general, the observation that polymers with tetra-substituted carbon atoms tend to degrade and chain scission holds in most instances. This is the case for PVdC, for polyisobutylene (PIB) and its isoprene copolymers, butyl rubbers (IIR), for polymethylmethacrylate (PMMA) and for polytetrafluoroethylene (PTFE). Figure 47 illustrates the tetra-substitution on PTFE and PVdC, polymers well known to undergo chain scissioning when exposed to ionizing radiation [123].

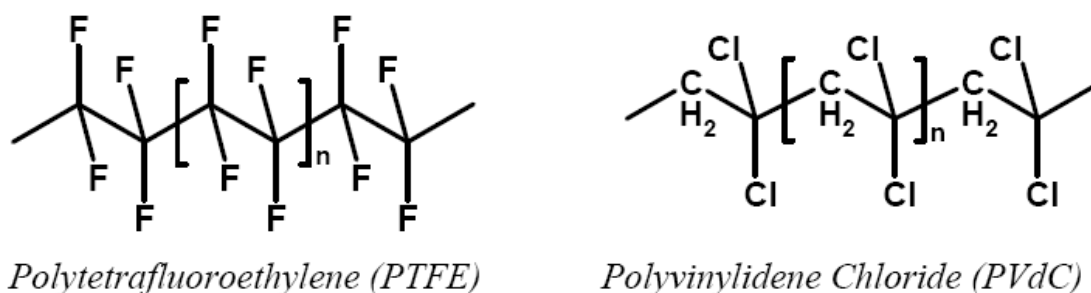

Figure 47. Tetra-substituted Chain Scissioning Halogenated Polymers

Polyvinylidene fluoride (PVdF) is an exception. PVdF radiation crosslinks and is used as a high temperature jacketing on wire, especially aircraft wiring, and for certain specialty heat shrink products [124]. Fluoropolymers are used for high temperature properties, for their chemical and oil resistance and for flame retardancy. An alternating copolymer of ethylene and tetrafluoroethylene (ETFE) is also radiation crosslinkable. This is a more elastomeric material that is also used in wire and cable jacketing. A copolymer of hexafluoropropylene and tetrafluoroethylene (FEP) will chain scission when irradiated at room temperature, but can crosslink if the radiation is conducted slightly above its melt transition, 260°C [125]. Similar results have recently been found for PTFE when electron beam exposure is conducted above the melt transition (340°C) and in an inert atmosphere [126, 127]. Crosslinking takes place and upon cooling, PTFE loses its highly crystalline structure and a near-transparent material results. The commercial merits of high temperature FEP or PTFE crosslinking have to be weighed against the performance properties that can be obtained with more easily processable fluoropolymers, as PVdF and ETFE, which will radiation crosslink at room temperature. Figure 48 illustrates the saturated, tetra-substituted structure of PVdF, which radiation crosslinks.

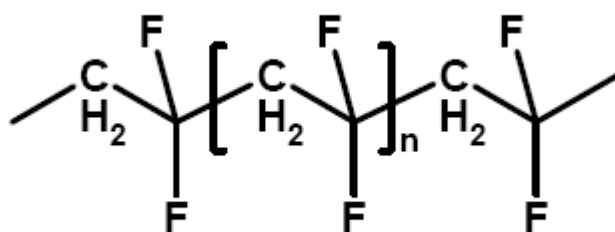

Figure 48. Polyvinylidene Fluoride (PVdF)

With irradiated thermoplastics such as polyethylene and polypropylene and with the fluoropolymers, crosslinking and scissioning take place in the amorphous regions of the polymer. Crystalline domains which determine melt transitions, T_m , are thus mostly unaffected. While one can enhance the properties of a thermoplastic above its melt transition using electron beam crosslinking, one cannot change the transition temperature itself. Thermal mechanical analysis (TMA), as in ASTM E-1545, or differential scanning calorimetry (DSC), as in ASTM E-1356, can also be used to determine melt transitions and will still show melt transitions even as the crosslinked polymer is heated in a test instrument [128]. Since the radiation response of polymers is grade specific, one cannot simply rely upon general material

Table VII. Properties of Plastic Polymers

Polymer	Thermal Properties, °C		Density	Radiation Response
	T _m	T _d		
<u>Polyethylenes:</u>				
metallocene (mPE)	60-105	---	0.870-0.915	X
low density (LDPE)	98-115	40-44	0.917-0.932	X
linear low density (LLDPE)	122-128	55-62	0.918-0.940	X
high density (HDPE)	130-137	79-91	0.952-0.965	X
ultrahigh molecular weight (UHMWPE)	125-135	68-82	0.940	X
vinyl acetate copolymers (EVA)	61-105	---	0.925-0.960	X
acrylic acid copolymers (EAA)	94-102	---	0.924-0.958	X
methyl acrylate copolymers (EMA)	75-102	---	0.928-0.945	X
ethyl acrylate copolymers (EEA)	95-98	31-33	0.930-0.931	X
butyl acrylate copolymers (EBA)	86-93	---	0.926-0.928	X
vinyl alcohol copolymers (EVOH)	156-191	80-100	1.120-1.200	X
<u>Polypropylenes:</u>				
metallocene (mPP)	149	94	0.900	S
homopolymer (PP)	168-175	107-121	0.900-0.910	S
ethylene copolymers (PP)	131-164	71-115	0.890-0.910	S/X
<u>Halogenated polymers:</u>				
unplasticized vinyl chloride (PVC)	75-105	57-82	1.300-1.580	S/X
vinylidene chloride (PVdC)	150	---	1.600-1.780	S
vinylidene fluoride (PVdF)	135-175	68-140	1.760-1.800	X
ethylene-tetrafluoroethylene (ETFE)	270	81	1.700-1.720	X
fluoroethylene-propylene (FEP)	257-263	70-77	2.130-2.150	S
ethylene-chlorotrifluoroethylene (ECTFE)	220-240	90-92	1.680	S
tetrafluoroethylene (PTFE)	230	73-140	2.150-2.300	S
<u>Rigid clear plastics:</u>				
polystyrene (PS)	83-100	78-103	1.040-1.080	O
polymethylmethacrylate (PMMA)	100-105	80-103	1.150-1.190	S
polyethylene terephthalate (PET)	243-250	68-72	1.300-1.330	O
polycarbonate (PC)	143-150	115-143	1.170-1.450	O

X = crosslinks; S = scissions; S/X = scissions, formulations crosslink; O = neutral.

For PS, PMMA and PC, the glass transition temperature, T_g, is listed and not the melt transition, T_m; T_d = the heat deflection temperature per ASTM D-648 at 0.46 MPa.

3.5. Elastomers

Unlike thermoplastics, whose dominant market uses rely upon properties attainable as non-crosslinked materials, elastomers require crosslinking in order to exhibit commercially useful properties. Almost all of the widely used elastomers have a reactive double bond within their polymer structure. Radiation exposure opens these double bonds to then form crosslinks. Radiation crosslinking of natural rubber was one of the first industrially significant discoveries involving electron beam effects on materials [129]. The polymers commonly used in tire manufacture are radiation crosslinkable: cis-polybutadiene (BR) for long wearing tread compounds, natural rubber (NR) or synthetic polyisoprene (IR) and styrene-butadiene (SBR) for blends and ethylene-propylene diene rubbers (EPDM) for ozone resistant sidewalls [100, 101]. The response of each elastomer type is dependent not only on specific characteristics of the elastomer but also upon adroit formulating. The radiation response of EPDM rubbers has been well studied [130]. Even a polymer type known to chain scission with radiation, the isobutylene-isoprene copolymer butyl rubber (IIR), when halogenated (as bromo-butyl rubber – BIIR) and properly formulated can crosslink under radiation and is used for tire innerliners [131]. Halogenated isobutylene-isoprene copolymers can be dehydrohalogenated to yield a conjugated diene butyl (CDB), which will radiation crosslink even without formulation [132, 133]. Figure 50 illustrates polyisobutylene, which is ~97% of the polymer backbone of IIR or BIIR rubber and well known to scission, and that of the experimental conjugated diene butyl, which crosslinks under irradiation. This shows how subtle changes in polymer backbone can effect whether scissioning or crosslinking dominates on exposure to electron beams or X-rays.

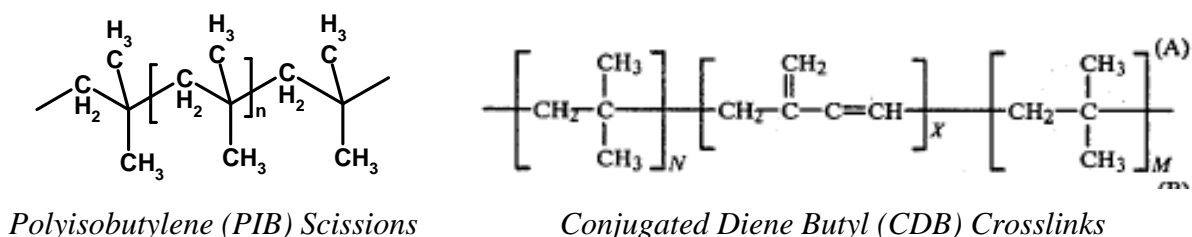

Polyisobutylene (PIB) Scissions

Conjugated Diene Butyl (CDB) Crosslinks

Figure 50. Polyisobutylene Polymers

3.6. Thermoplastic Elastomers

Thermoplastic elastomers (TPE) can be either block copolymers or blends of a thermoplastic polymer and an elastomer. Block copolymers are reactor produced materials which can be processed as thermoplastics, but when cooled exhibit rubbery or elastomeric properties. These are styrene-isoprene-styrene (SIS), styrene-butadiene-styrene (SBS) or the saturated mid-block materials, styrene-ethylene/butylene-styrene (SEBS) or styrene-ethylene/propylene-styrene (SEPS) copolymers. By reducing the styrene in SIS or using a saturated mid-block copolymer, these materials can be formulated to be EB responsive [134].

Thermoplastic elastomers based on polyolefins (TPO) are blends of PEs or PPs with EPDM elastomers wherein the elastomer is often crosslinked using thermo-chemical systems [135]. TPOs more suitable for medical products with no chemical residuals could be made using EB processing to crosslink the elastomer portion in such an elastomer-plastic blend. The thermoplastic governs the melt transition and thus the extrusion properties of TPOs. The radiation response of these materials is also governed by the choice of the thermoplastic.

3.7. Monomers and Oligomers

Monomers and low molecular weight oligomers, typically $M_w < 40,000$, are radiation polymerized in-situ to form the crosslinked binders of inks and of coatings and to form functional adhesives. Low-voltage electron beams are used with these materials in high volume operations. These materials are formulated and then applied as liquids. Radiation crosslinking yields functional materials with there being little to no emission of volatile organic compounds, near-zero VOCs. As a result, this technology has gained recognition as an inherently “green” chemistry [15]. Most often free radical in-situ polymerization and crosslinking relies upon the terminal vinyl or unsaturation of acrylate monomers [12, 71]. Monofunctional, di-functional and poly-functional monomers are typically very low in viscosity. Specific monomers are chosen for defined end-use performance properties. As shown in Figure 51, monofunctional monomers are either acrylate or methacrylate materials with differing substitutive groups (R) that polymerize via their double bonds with themselves and with other monomers or oligomers into a crosslinked network. Di-functional monomers also have various mid-section constituent groups, but are also terminated with an acrylate double bond. A commonly used tri-functional acrylate is trimethylol propane triacrylate (TMPTA). This is also used to enhance the radiation response of polyethylenes and polypropylenes, as in wire and cable formulations and radiation crosslinkable polypropylenes.

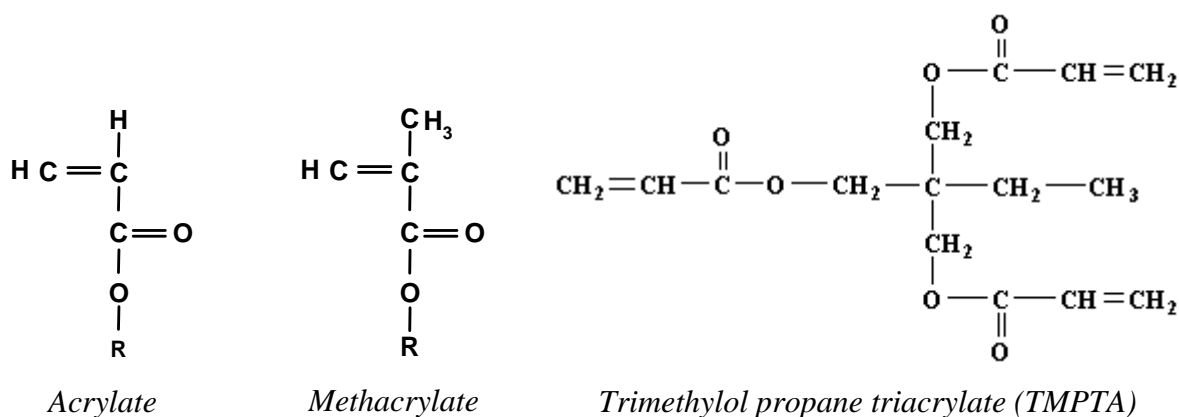
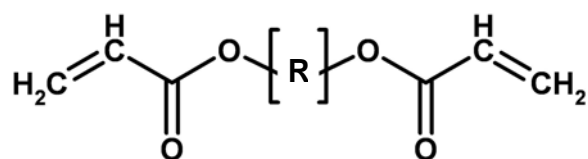

Figure 51. Acrylic Monomers used in Inks, Coatings and Adhesives

To attain properties such as elongation or flexibility, low viscosity radiation curable formulations often also contain oligomers, which are some material of higher molecular weight that is a viscous liquid. The substitutive R group in oligomers can be an epoxy, a polyester, a urethane or even an acrylate structure. The resulting crosslinked system then exhibits more of the properties of this substitutive group [15, 71]. Figure 52 is a generic structure for commonly used acrylated oligomers. These liquid materials have molecular weights (M_n) of less than 10,000 Daltons.



where R = epoxy, polyester, urethane or acrylate mid-segments

Figure 52. Acrylated Oligomers Used as Precursors in Radiation Curing

3.8. Grafting

Radiation grafting has been a well known technique for modifying the surfaces of materials for many years [136]. Grafting adds a monomeric or low molecular weight moiety to a high molecular weight formed polymer, which can be a film, a non-woven, a micro-porous film or a bulk material, to affect various properties. Grafting can be defined as the ability to attach or grow a different material onto the backbone of another. With polymeric materials, the “different” material is most typically a monomer and the “backbone” a polymer or other solid. A chemical bond is then formed between the grafted moiety and the material. Low-energy EB processing is especially suited for surface grafting.

Grafting has been used to enhance the biocompatibility of polymers [137]. Grafting is used to control the ion flow through battery separators (Section 6.3), the hydrophilic or hydrophobic properties of filters (Section 6.4), and is being explored for developing fuel cell membranes (Section 7.9). Silanes can be grafted onto polymer film surfaces to impart release or non-adherent properties [138]. Table VIII lists the variety of uses and potential applications for the EB grafting of materials.

Table VIII. EB Grafting of Polymers

Accepted commercial uses:

- 1 – Battery separator membranes
- 2 – Micro-porous membranes and non-wovens
- 2 – Release coated films and papers

Developed uses in early stages of commercialization:

- 1 – Absorbents for metal ions
- 2 – Odor absorbent fabrics
- 3 – Substrates for cell tissue growth
- 4 – Surface modification of glass windows for ease of cleaning

Developmental uses:

- 1 – Compatibilization in heterogeneous composites
- 2 – Fluoropolymer membranes for fuel cells

Long range opportunities:

- 1 – Select grafted films for biomedical use as transdermal systems
- 2 – Modification of fabrics for flame retardancy

Known uses not commercialized:

- 1 – Bulk polymer modification to enhance adhesion
- 2 – Ion exchange membranes
- 3 – Controlled gas permeation of food packaging films

3.9. Water Soluble Polymers

Water soluble polymers such as polyethylene oxide (PEO), illustrated in Figure 53, and polyvinylpyrrolidone (PVP) are used in the radiation formation of hydrogels [139, 140, 141]. Solutions of only ~4% to ~10% of PEO in water will form a gel at very low doses, typically <10 kGy. PVP is also very radiation responsive. Polyethylene glycols (PEG) and polyvinyl alcohols (PVA) have also been used in these systems, but PEO is the most widely used. The ethylenic structure of this polymer is very amenable to radiation crosslinking.

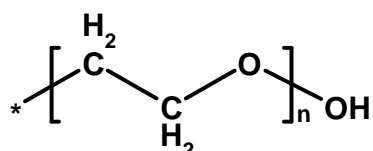

Figure 53. Polyethylene Oxide

3.10. Natural Polymers

Cellulose is known to chain scission when exposed to irradiation [142, 143]. With low energy electron beams, the doses needed to cure inks or coatings are generally low and beam penetration is limited so that possible degradation of paper substrates is minimized. Higher doses will cause darkening of paper. Attempts have been made to use electron beam irradiation to enhance the digestion of cellulose for paper manufacture by irradiating wood chips [144, 145]. The fracture of the cellulose molecule is believed to occur at the oxygen linkages between adjacent ring structures. Figure 54 illustrates the molecular structure of cellulose. Lignin, which consists of phenols, protects cellulose in wood from radiation damage. The toughness of cellulose based materials, as wood and plant fibers, is attributed to hydrogen bonding between adjacent molecules.

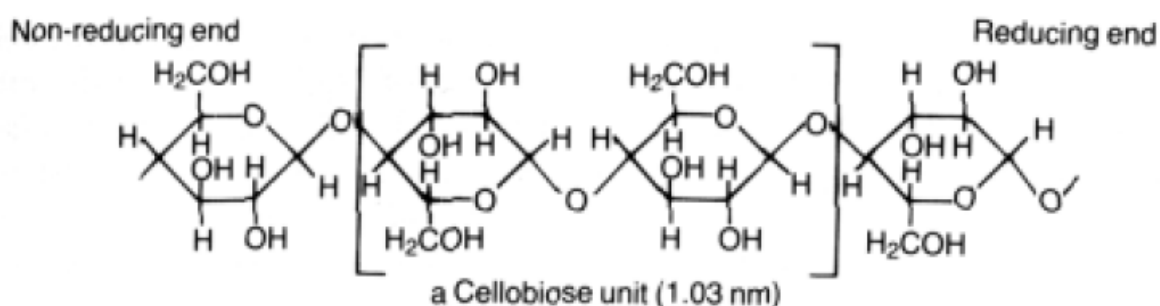

Figure 54. Cellulose

3.11. Living Matter

Deoxyribonucleic acid (DNA) forms long chain molecules that are also held together by hydrogen bonding. Inspired by Erwin Schrödinger's "What is Life?" series of lectures, James Watson and Francis Crick defined the structure of DNA as a series of base pairs organized as a double helix [146, 147]. The base pairs of nucleic acids are A+T (adenine and thymine) and G+C (guanine and cytosine) as shown in Figure 55. Figure 56 illustrates the pairing of these

bases along the double stranded helix with the sugar and phosphate structures on the exterior of the helix.

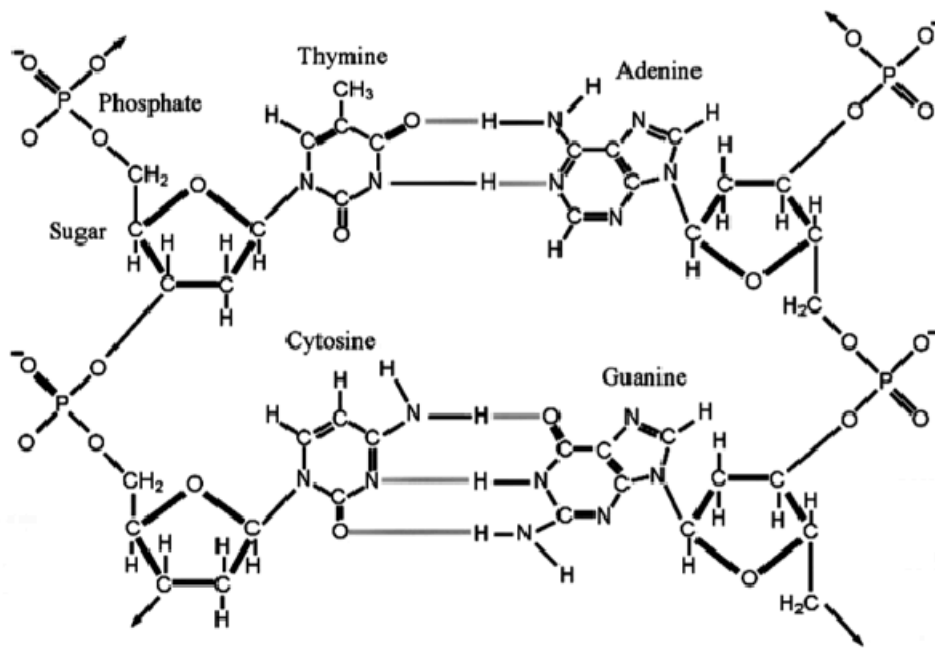

Figure 55. Base Pairs of DNA

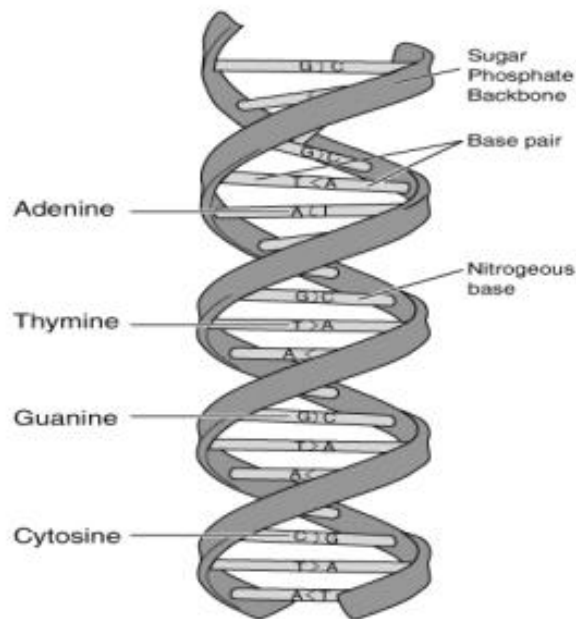

Figure 56. DNA Double Helix

This molecular architecture of DNA is self-replicating and thus forms the basis of life and genetic encoding [148]. However, such self-replication is a time-dependent phenomenon, occurring in a matter of seconds. Some bacteria can replicate at a rate of 500 nucleotides per second. DNA also has the remarkable ability to repair itself. Low levels of radiation exposure at low dose-rates may actually stimulate DNA replication (radiation hormesis) [149, 150].

Many studies have been conducted using low dose-rate cancer therapy equipment at what are from industry's point of view very low doses, in the order of grays, not kilograys. Extrapolations from these low dose and low dose-rate experiments have been made to project cell death or survival. Likewise, many studies have been conducted using low dose-rate gamma-ray irradiation and not the high dose-rates attained with industrial accelerators [151]. In cancer therapy, for example, low doses are given over sequential timeframes of many days so as to permit healthy tissue adjacent to cancerous cells time to recover. Two models for cell death have thus been developed. One based on linear extrapolation for sequential radiation events and another based on a linear-quadratic model where the entire dose is to be delivered at once [152]. Figure 57 illustrates this difference in modeling based on survival fractions at low doses.

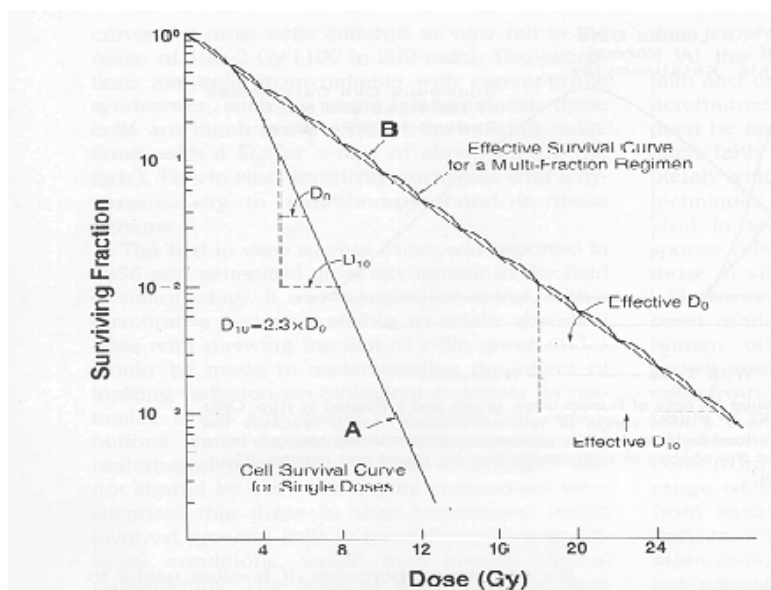

Figure 57. Survival Fractions with Low Dose Radiation Exposure

Since industrial irradiation processing is interested in total cell death, it would seem that the curved linear-quadratic model would be more apropos and dose should be delivered at once in as short a time as possible. DNA itself is a very large molecule. The average molecular weight of one base-pair is ~660 Daltons. Bacterial cells, which sterilization and decontamination processes seek to kill, have ~1,000,000 base-pairs. A base pair consists of the dyad of the nucleotides adenine and thymine (A+T) and guanine and cytosine (G+C) [153]. Thus, bacterial DNA is on the order of 660,000,000 Daltons. *Escherichia coli* is about half this, but of the same order of magnitude. Human DNA is 1000 times as large a molecule. The synthetic organic polymers noted above are in the order of 100,000 to 300,000 Daltons M_w. Monomers used in surface curing applications are in the order of only a few hundred Daltons. The early work of Arno Brasch and Wolfgang Huber indicated that dose delivered in a short time interval was more effective in killing organisms [57, 58]. Pulsed radiolysis studies in the mid-1970's on *Bacillus magaterium* spores by Alan Tallentire and colleagues showed the efficacy of higher dose-rates as being more lethal to biological matter [154, 155, 156, 157]. At high dose-rates, the probability of radical-radical interactions increased and lethal events occurred beyond those observed at low dose-rates [154]. More recent investigations have also shown the efficacy of higher dose-rates in reducing the "dose-to-kill" of living matter [158].

EB or X-radiation generates free radicals and, in the presence of water, a constituent of all living matter, highly reactive short-lived hydroxyl radicals. Both can lead to single and double-strand breaks, intra-strand cross-links and thus damage DNA, including breaking the hydrogen bonding between the nucleotides in the dyad. With but a few double strand breaks, DNA is no longer able to repair or replicate itself, as illustrated in Figure 58 [105]. Without the ability to correctly replicate their own DNA structure, cells die. Pathogens in food or on medical products exposed to sufficient ionizing radiation are then killed and bio-burdens eliminated.

As pointed out, studies upon which standards and protocols have been based have almost exclusively been conducted using low dose-rate gamma-ray sources [151]. Industrial electron beam accelerators function at dose-rates that are five orders of magnitude greater than gamma-ray sources (Table III). Since lethality or “cell death” is dose-rate dependent and occurs in fractions of a second with EB, leaving insufficient time for DNA to repair itself, the potential for terminal sterilization, that is killing of all pathogenic material, at lower doses exists. Even X-rays, which are only one order of magnitude greater in dose-rate than gamma rays, offer this possibility. The practical consequence would be to permit users of sterilization processes to use lower doses which implies faster processing rates and lower energy consumption and might also permit the use of lower cost materials that do not need as high a level of radiation tolerance. X-rays have already been shown to be an alternative to the use of radioactive gamma-ray sources in such sterilization processes. A US National Academies report on **Radiation Source Use and Replacement** acknowledged this possibility [159].

In lieu of conventional cell survival studies, which take days for cultures to grow or not grow, contemporary techniques of molecular biology could be applied to DNA fragments to see if this large molecule has been sufficiently scissioned. The polymerase chain reaction (PCR) would multiply any fragments that could possibly replicate by orders of magnitude of ~1,000,000. If there is no PCR sequencing, then the DNA is so fragmented that any living form could not propagate. In other words, the life forms, such as a bacterium or fungus, are dead. PCR has been used in forensics work to confirm the decontamination of environments, such as the offices that were exposed to the deadly anthrax strain [160].

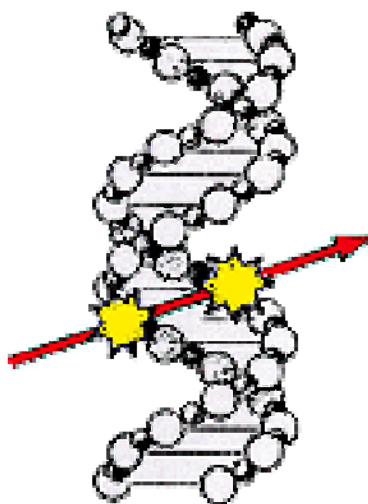

Figure 58. Radiation Induced Double Strand Break of DNA

4. PROCESS DOSIMETRY

In radiation, the term “dose” was derived from the medical community’s interests in using this form of energy for treatment or diagnosis. As with gravimetric or volumetric measures used in medicinal treatments, there was a need to quantify how much radiation was being received by a patient. In Coolidge’s experiments in the mid-1920s, only the beam parameters of voltage and amperage and under-beam conditions, as distance from the window and time of exposure, were spelled out [41, 42, 43]. Likewise, an early patent on the irradiation effects on a material, the electron beam crosslinking of natural rubber, issued in 1933, too describes process parameters with no mention of “dose” [129]. In 1925, the International Commission on Radiological Units (ICRU) was formed and by 1928 the Roentgen was defined as a quantity of absorbed energy as measured by the ionization in a free air chamber [161].

In the medical community today, calibrations are still made using air kerma measurements in a free air chamber. These calibrations are being replaced by water calorimetry (absorbed dose-to-water). The dose-rates of medical therapy and medical X-ray equipment are low enough to permit such air kerma and calorimetry measurements. Likewise, the paradigm for industrial irradiation has been established based upon low dose-rate gamma-ray sources. Table III, however, shows that there is a fivefold order of magnitude difference in dose-rates between gamma-ray sources and industrial electron beam accelerators. The discussion of material effects indicates that in some instances dose-rate is of consequence. Water calorimetry or graphite calorimeters, that can be used with gamma-ray sources, are not practical with high-current, high dose-rate industrial electron beams, under the conditions of use, where products are passed through the beam at relatively fast speeds [162, 163].

Over the decades, the term “dose” has evolved through the use of “Roentgens” to “Rads” and now the “gray” which is an accepted unit in the Systeme International. Roentgens and Rads were almost numerically equivalent. The conversion from Rads or, as used in industry, megarads (MR), to kilograys is easy, simply multiply MR by ten. “Absorbed dose” is defined as what is absorbed by the material, not by what is emitted from the source. The gray is the amount of energy absorbed per unit mass with one gray = 1×10^4 ergs/gram. The commonly used kilogray (kGy) = 1 joule/gram = 0.24 calories/gram = 0.24 °C rise in the temperature of water per kGy. Water has a specific heat of 1.0 calorie/gram °C.

It should be noted that for the most part, with the exception of when involved in regulated regimes dealing with food and “sterile” materials such as medical devices, industrial electron beam processing most often relies upon performance parameters [164]. Inks and coatings are subjected to solvent rubs per ASTM D-5402 to determine cure or the effects of EB processing on them [112]. Partially EB cured rubbers are evaluated in the tire industry by measuring the modulus increase per ASTM D-412 [109]. The EB crosslinked thermoplastics, such as those used in wire and cable jacketing and for heat-shrinkable tubing and films, are evaluated for their modulus above the melt transitions of the thermoplastics as per ASTM D-638 and D-882 [107]. Numerous other performance parameters are used in the industrial community to establish process conditions of beam voltage, current and under-beam transport speed. “Dose” is a linguistic means that enables various practitioners and their suppliers to communicate. This term is often used in a colloquial sense rather than as a precise unit of measure. Despite many decades of papers and publications, there has not yet evolved an

agreed upon measurement system for quantifying the radiation exposure of materials as used by most of the radiation processing industry, those using electron beam processing. There is a plurality of options from which “dose” is often inferred even though such inferences are based on calibrations that are made with gamma-rays at dose-rates which are several orders of magnitude lower than those used in industrial electron beam processing.

To determine the absorbed dose for electron beam processing, there are a couple of options: 1) assign dose from Monte Carlo probability codes and area through-put equations noted above or 2) infer dose using a surrogate (a dosimeter or dose meter) that has proven reliability and is stable with respect to irradiation response or one that relates to the materials that are actually being processed. Some Monte Carlo codes require data entry and even data export from computers operating in a “disk operating system” or DOS [165, 166, 167]. Using DOS makes codes sensitive to how data is entered and how it can be exported. One code that has overcome this and has an interface that is compatible with the operating systems used on present day computers is the Radiation-Technological Office (RT-Office) program [168]. This program accepts data entry from user-friendly input screens, runs Monte Carlo, and presents data in easily understood graphics. RT-Office can be used across the entire energy range used in industrial electron beam processing, from 10 MeV to even very low energies of 80 keV.

4.1. Alanine Dosimetry

Two surrogates or “dosimeters” can be effectively used with EB processing. Since EB processing involves high speed product through-put, both can generate responses in a minimum of time, only a few minutes at most. Of the numerous studies that have been conducted on dosimeters and dosimetry, alanine, an amino acid, has been shown to give the highest degree of precision upon exposure to electron beam irradiation [169]. Inter-comparisons between measurements made using low dose-rate gamma-ray sources and high dose-rate EB indicate that alanine dosimeters are not sensitive to dose rate. Alanine forms a very stable free radical which has a property response that can be detected by electron paramagnetic resonance (EPR) also known as electron spin resonance (ESR) measurements. This radical is almost unique in its long term stability and its insensitivity to most environmental conditions [170]. Alanine dosimeters are available in pellets or as coatings on polyester films. The US National Institute of Standards and Technology (NIST) has incorporated automated alanine dosimeter reading into its development of an electronic traceability/certification system which, when fully operational, will be able to certify dosimetry measurements twenty-four hours a day, seven days a week (24/7) [171]. Figure 59 shows an alanine pellet or alanine coated film electron paramagnetic resonance (EPR) reader that can be linked by tele-networking to the NIST system. The films are all bar-coded and the reader stores this identification along with the EPR reading to provide in-house traceability.

Monte Carlo (ITS3 Tiger code) calculations were used to illustrate the influence of the air gap on the penetration of electron energy into an alanine coated film dosimeter [172]. For the lowest energy commercially available EB unit (80 keV), input to the code was for a 6 μm titanium foil window, 144 μm of alanine coating (adjusted to include both the alanine itself and its binder) and 150 μm polyester film backing. Figure 60 shows the results of energy deposition into the alanine coating when using a beam energy of 80 keV. An inflection in the deposition curve indicates the transition between absorption in the air gap and in the alanine

coating. With a 1 cm air gap, most of the energy is absorbed in the alanine coating. As with all dosimeters, at these very low beam energies there is a depth-dose profile within the coating or dosimeter itself and not the equal-entrance, equal-exit conditions encountered with higher energy EB units. At a 5 cm air gap, very little of the beam energy is left to penetrate into the dosimeter, around only 20% or less. These results show the sensitivity of low energy electron beams, 80 keV to 300 keV, to loss of energy in air indicating that, for optimum performance, tight control over the air gap between the beam window and target substrate should be maintained. This underscores the need for tight process control of the air gap between the beam window and the target substrate when using low-energy EB units.

Alanine coated dosimeters were found to be sensitive and responsive to very low-energy electron beams, 80 to 120 keV, even at very low beam currents [164]. Figure 61 shows that at these very low beam energies, the alanine exhibited a precise agreement of the alanine/marker ratio to beam current at low beam currents (<2 mA). The EPR device (Figure 59) has an internal reference crystal called a marker. The spin resonance signals generated by the free radicals in the alanine are taken with reference to this marker and expressed as the alanine/marker ratio. Trend-lines became superimposed upon actual data plots to exemplify the linear response of alanine to very low electron beam energies and beam currents. Even though the alanine coating itself is too thick (144 μm) for very low-energy EB penetration, rendering a depth-dose profile within the coating itself, only the alanine coating response has been shown to be sensitive enough to repeatedly detect EB exposure at as low as 80 keV, with low beam current. Alanine coated films are dose-rate independent and appear capable of responding across the range of electron beam energies used in industry, 80 keV to 10 MeV.



Figure 59. EPR Reader with Possible NIST Electronic Traceability

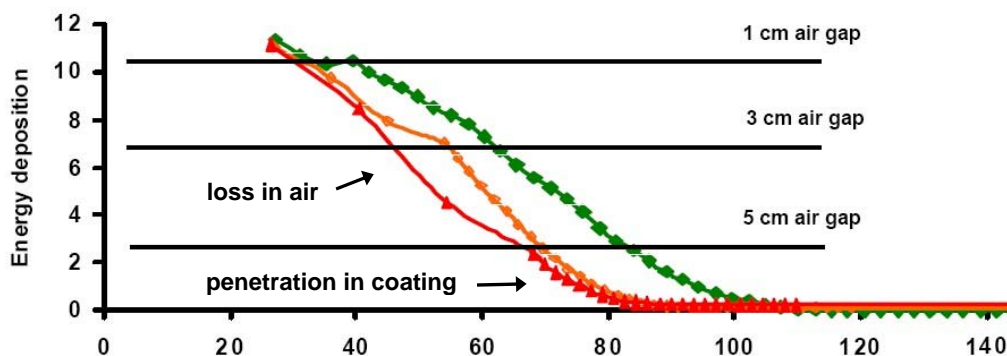

Figure 60. Loss of 80 keV Electron Beam Energy in Air with Change in Gap Distance, Penetration Measured in μm Unit Density

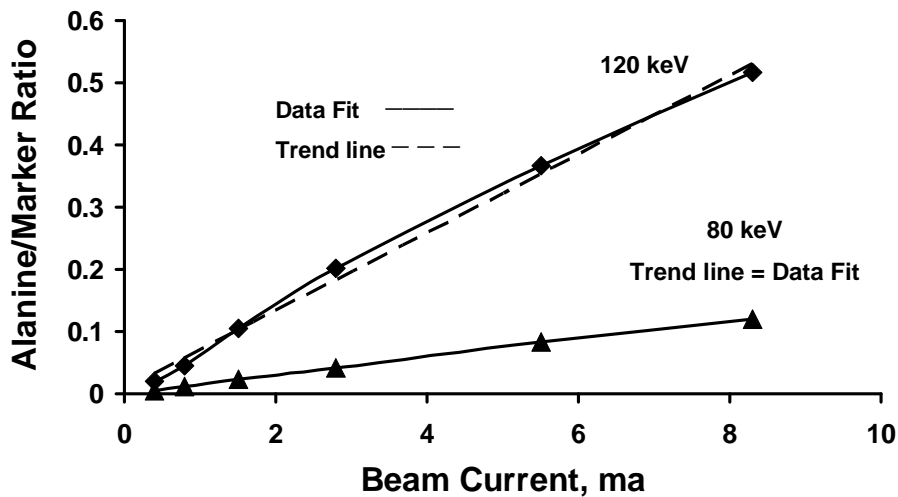

Figure 61. Alanine/marker Ratio Sensitivity to Beam Current at Very Low Energies

4.2 Polyethylene Dosimetry

The other surrogate is to use polyethylene (PE) itself, the most widely used material in industrial EB processing, to indicate irradiation exposure [111, 173, 174, 175, 176, 177, 178]. Two ASTM International Standard Methods of Test use Fourier Transformation Infra-red Spectroscopy (FTIR) to monitor the development of transvinylene in irradiated PE, Figure 62. ASTM D-6248 uses the peak at 965 cm^{-1} in PE, preferably using higher crystallinity high density PE (HDPE), to follow irradiation response [179]. In the medical device area, ASTM F-2381 determines a transvinylene index (TVI) to assess the effects of irradiation on PE used in implants. The transvinylene index is the ratio of the absorption peak area between 950 and 980 cm^{-1} to the absorption peak area between 1330 and 1396 cm^{-1} [180]. PE itself is very inert and can be made into films or molded test pieces of very precise dimensions. FTIR can also be used to indicate the degree of cure and crosslinking of acrylate monomers and oligomers that are used in inks, coatings and adhesives and for composite matrices. The reduction in the response at 810 cm^{-1} reflects the disappearance of the acrylate double bond due to incorporation into a cured and crosslinked polymer network [181].

Photochromatic dosimeters, which exhibit sensitivity to light, moisture and temperature, have gauge thickness variations and require time to stabilize for measurements [182]. In contrast, PE sheet and films are stable and produced commercially to constant gauge thicknesses. A $25\text{ }\mu\text{m}$ blown HDPE film was irradiated using a laboratory EB unit, as shown in Figure 39, at different nominal dose settings, ranging from 25 to 300 kGy with the beam energy 125 keV and a 2 cm air gap between the film and the beam window. Monte Carlo modeling showed that using 120 keV beam energy with a 2 cm air gap and $6\text{ }\mu\text{m}$ Ti window, nearly equal-entrance, equal-exit conditions could be attained, Figure 63. Transmission FTIR at the 965 cm^{-1} was found to be linear across this broad range, as shown in Figure 64. A compact unit with Attenuated Total Reflectance (ATR) FTIR, Figure 65, showed PE absorbance at the 965 cm^{-1} transvinylene peak, as shown in Figure 66. ATR examines at most the first two microns near the film surface, thus eliminating concerns over the depth of EB penetration for very low-energy EB units [183].

Alanine coated films were concurrently irradiated at 3 MeV along with 890 μm HDPE sheet and 38 μm LDPE film with multiple passes under the beam, as shown in Figure 67. Monte Carlo calculations showed that at 125 keV, routinely manufactured 38 μm LDPE film would exhibit an equal-entrance, equal-exit beam penetration, Figure 68. Both transmission FTIR with the HDPE sheet (Figure 69) and ATR FTIR with the LDPE film (Figure 70) showed linear agreement with the alanine coated film, a recognized transfer dosimeter [184].

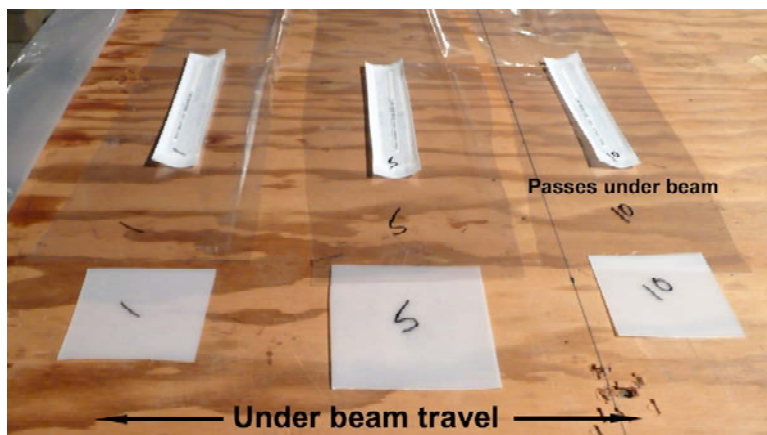

Figure 67. Concurrent Irradiation of HDPE Sheet, LDPE Film and Alanine Coated Dosimeters

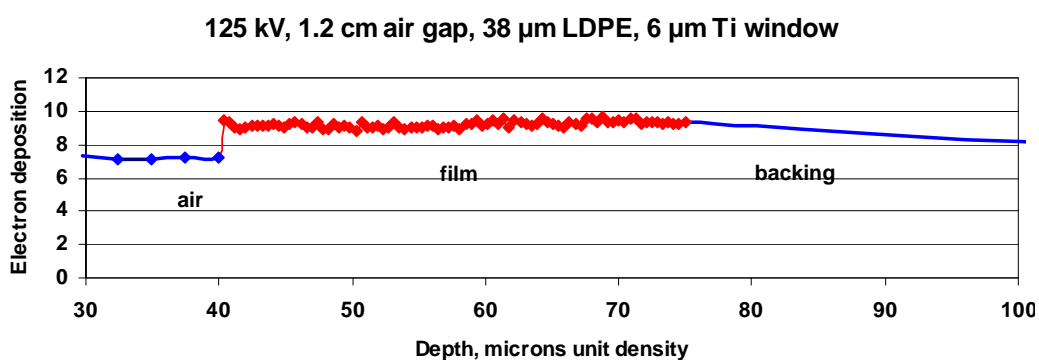

Figure 68. 125 kV EB Penetration into 38 μm LDPE Film

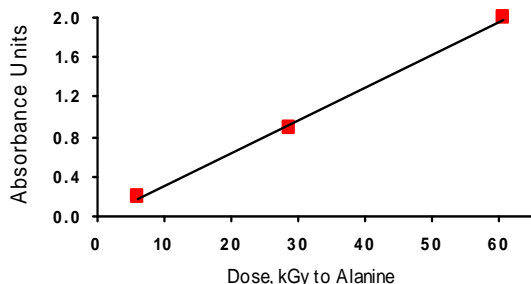

Figure 69. Transmission FTIR HDPE Sheet

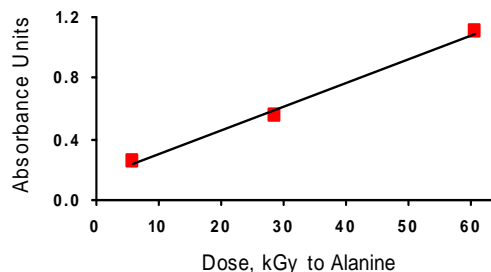

Figure 70. ATR FTIR LDPE Film

5. END-USE APPLICATIONS

5.1. Wire and Cable Insulation

The electron beam crosslinking of the insulation jacketing on wire and cable is one of the most well established industrial uses of EB processing. Crosslinking prevents insulation from dripping off an over-heated wire, as could result from a short circuit, or when exposed to the high heat of an automotive engine or even a fire. Specialized under-beam fixtures, as shown in Figure 71, have been developed to transport wire using multiple passes under the beam [18, 185]. The wire is slightly turned during each pass so as to improve the uniformity of exposure even if the copper conductor would be thick enough to prevent beam penetration. Cross-firing beams at plus and minus 45 degrees can also enhance dose uniformity. Pay-off and take-up equipment has been designed so that the entire process can run at several hundred meters per minute. Depending upon the end-use requirement, wire jacketing is most often made from formulated polyethylene. Blends of polyethylene and ethylene-propylene rubber are used if greater flexibility is needed, especially as the diameter of the jacketing increases as for cables. Table IX presents a typical radiation crosslinkable jacketing formulation [186]. When enhanced temperature resistance is required, polyvinylidene fluoride or other fluoropolymers are used [124]. Table VII presents the melt transitions for these materials. Fluoropolymers have the advantage of being oil resistant and flame retardant, but are also more expensive base materials.



Figure 71. Wire and Cable Under-beam Transport System

Table IX. Typical Flame Retardant Wire and Cable Formulation

PE/EPDM	100 parts by weight
Hydral 710	250
Zinc oxide	5
Process aid	10
Silane A-172	2
Antioxidant	1
TMPTA/TAC	5

The specific PE and/or EPDM will depend upon a variety of end-use and process considerations. Major producers of irradiated wire have formulated their own compositions. Hydral is aluminum tri-hydrate. This is a preferred flame retardant that liberates its water of hydration when exposed to flames in contrast to chlorinated materials which give off toxic gases as by-products. The process aid is typically an oil that enhances the ability to extrude such compositions. The silane is a coupling agent that improves the inter-action between the polymers and the aluminum tri-hydrate. As noted in the section on monomers, TMPTA enhances the radiation response as does tri-allyl cyanurate (TAC). One or the other is used. Crosslinking imparts two main properties to wire jacketing. First, should the wire itself become heated as, for example, due to an electrical short circuit, the crosslinked jacketing will not melt off of the wire and will maintain its insulation. This is very important for under-the-hood wires used on automobiles. Second, when exposed to flames, the jacketing will not burn away nor drip and propagate a fire. Such wire can meet industry flame retardant requirements, such as those in the US spelled out by the Underwriters Laboratory. Figure 72 contrasts the flame resistance of a crosslinked flame retardant insulation with one that is neither flame retarded nor crosslinked.



Figure 72. EB Crosslinked Flame Retardant Insulation

5.2. Heat-Shrinkable Tubing

One of the pioneers of industrial radiation processing, Paul Cook, formed his company, the Raychem Corporation, in 1957 to manufacture and sell radiation crosslinked wire systems. Cook also saw that a new product form could be made by taking advantage of the elastic recovery exhibited by stretched crosslinked polyethylene when brought above its melt transition. Heat-shrinkable tubing, as shown in Figure 73, is first extruded and then irradiated to a well specified exposure using under-beam fixtures as are used for insulated wire. The crosslinked tubing is then expanded using an innovative process for which Cook received a patent in 1963, as illustrated in Figure 74 [187]. During the expansion process the tubing is heated in a chamber to above the melt transition of the plastic, typically polyethylene. Since the plastic is crosslinked, it behaves as a weak rubber and can be stretched or expanded by controlled air pressure differentials inside and outside the tubing. The stretched tubing is then quickly cooled so as to lower its temperature below what would have been its melt transition temperature. The crystalline domains in the polymer then form again and serve to hold the plastic in the stretched or expanded state. Pieces of tubing are then used to cover wire connections with the tubing having many of the same properties as the wire jacketing. An adhesive or sealant can be coated within the tubing so that a waterproof seal is made over any

connection. Upon being heated during application, the tubing contracts and conforms to the connector or object inside it.



Figure 73. Heat-Shrinkable Tubing

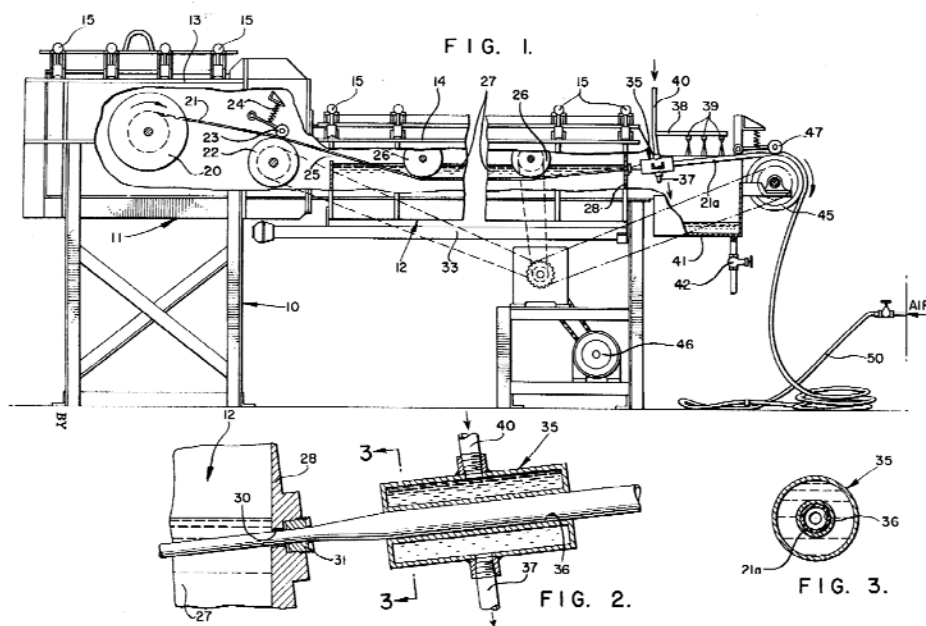

Figure 74. Cook, et al. US 3,086,242 of April 23, 1963, Tubing Expander

Heat recoverable closures for telecommunication splices and wraps for welded pipe joints have also been made. A heat recoverable sheet supplied as 35 cm wide tape was used as the supplementary corrosion protection for the 600 kilometers of the below grade sections of the 120 cm diameter Alyeska pipeline. This material remains functional after over 30 years of service in harsh conditions and attests to the durability of radiation crosslinked polyethylenes.

5.3. Heat-Shrinkable Food Packaging Films

Following a visit to Paul Cook's Raychem operation to see what was being done with radiation crosslinked polyethylene, Bill Baird returned to the Cryovac operation then part of the W. R. Grace & Company (now part of the Sealed Air Corporation) in South Carolina and developed an irradiation process for producing heat-shrinkable films for food packaging. Baird's concept, as shown in Figure 75, was to festoon an extruded tubular form under a beam, thereby absorbing most of the beam output, and then blow the irradiated material into the final film dimensions. This became known as the "double-bubble" process – one bubble

being the extrudate and the other the blown film [188, 189]. Heat-shrinkable films can consist of multi-layer co-extrusions which have a minimum of five layers: 1) a direct food contact layer of PE; 2) a tie-coat layer of a polyethylene copolymer; 3) a gas barrier layer, typically made from EVOH; 4) another tie-coat layer; and 5) an exterior layer PE for abrasion resistance on which information can be printed. Heat-shrinkable food packaging films are also made using low-energy (300 keV) EB units in conjunction with flat extruded sheet. Sheet is extruded and then irradiation and finally stretched using a tenter as is commonly used in the plastic film industry to orient films.

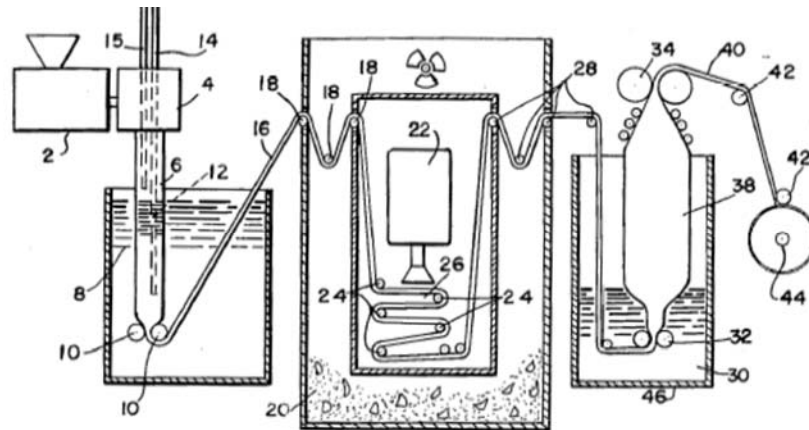

Figure 75. Baird, et al. US 3,022,543 of February 27, 1962, "Double-Bubble" Process

Self-shielded, 500 keV accelerators are preferred for this process, as shown in Figure 76. Over the course of many decades of successful business, Cryovac (Sealed Air Corporation) has been known to operate more electron beam accelerators than any other company. In contrast, Raychem (Tyco Electronics) has fewer accelerators, but historically has had the greatest levels of beam power, using high-current 3.0 and 5.0 MeV beams. Figure 77 shows ten of the self-shielded Cryovac EB units in a row in one factory [190]. It is important to note that these two major market uses for radiation processing were developed by pull from the end-users of radiation processing, not by market push from equipment manufacturers.



Figure 76. Self-shielded 500 keV Electron Beam for Shrinkable Film



Figure 77. Ten Self-shielded EB Units in One Factory

5.4. Closed Cell Polyethylene Foams

Since electron beam processing takes place at ambient temperatures, PE to be blown can be crosslinked without inadvertently activating a blowing agent. Voltek, now wholly owned by Sekisui Chemical Company, was originally formed as a joint venture between Sekisui and High Voltage Engineering to exploit this foam technology. Radiation crosslinking eliminates the attempt to use two competing thermo-chemical reactions, one to crosslink the PE and another to blow it into foam. With radiation processing, extruded PE with a blowing agent incorporated in it is crosslinked under an electron beam with minimal or no thermal input. The extrudate is then brought between plates and heated to release the gas from the blowing agent. The type of PE used, the amount of blowing agent, the radiation exposure and process for blowing, all contribute to a well defined closed cell foam structure [191]. A myriad of uses for these radiation crosslinked PE foams, including significant uses in automobiles for safety and protection, as shown in Figure 78, but most notably as a cushioning under the interior header. Such foams are also used as backing materials in the medical device industry, shown in Figure 79.



Figure 78. Automotive Uses EB Crosslinked PE Closed Cell Foams



Figure 79. Medical Device Uses of EB Crosslinked PE Closed Cell Foams

5.5. Tire Components

An early patent on an industrial use for electron beam processing was obtained by the B. F. Goodrich Company in May, 1933, on the use of electron beams to “vulcanize” natural rubber [129]. The ability to tightly control electron beam exposure enables tire manufacturers to only partially cure or crosslink elastomers. Elastomer components are extruded and then irradiated to bring them to a gel or green state. In that gelled state, the elastomers are tougher than the non-cured materials and this prevents tire cord distortion or strike-through during subsequent molding operations. The finished tire is knitted or fused together during the final thermal molding process [192]. Different elastomers are used for different functions in a tire. Properly formulated halogenated butyl rubbers (as BIIR) are used for innerliners [131]. Sidewalls are made from ethylene-propylene rubbers (EPDM) because of the inherent ozone resistance of this polymer. Chafer strips are also partially EB cured. Figure 80 shows where these various components are located in a finished, EB partially crosslinked and then thermally cured tire.

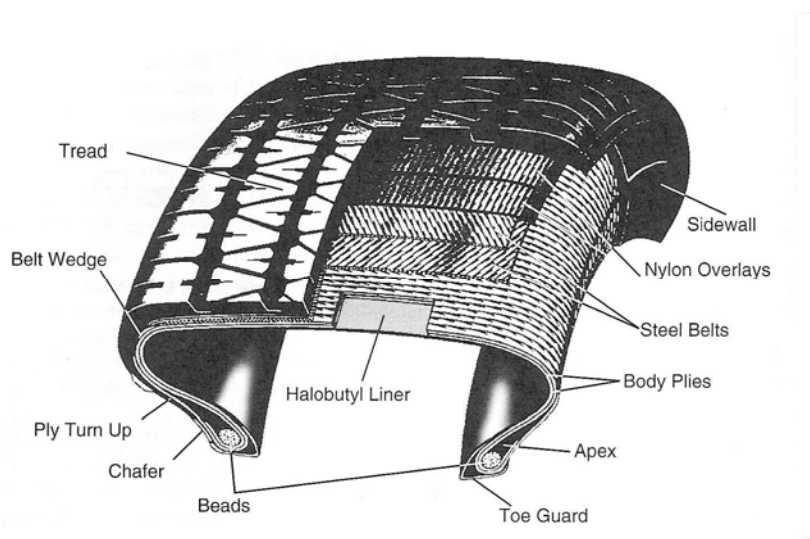

Figure 80. Cross-section Radial Ply Tire

5.6. PTC Heaters and Switches

Positive Temperature Coefficient (PTC) materials experience an increase in electrical resistance when their temperatures rise. This resistance in turn generates heat. A heating element can be made by placing a polymer filled with conductive carbon black between two electrodes [193, 194]. When incorporating a conductive carbon black into a polymer, care must be exercised so as not to overly disperse the black such that the polymer totally insulates the carbon particles and would thus negate their conductivity. As current is applied, the resistance, R , generates heat and an increase in temperature until a point at which there is a sharp increase in resistance, T_s , a switching temperature. At this point, the crystalline domains in a thermoplastic melt, and the difference between the thermal expansion of the polymer and that of the carbon black disrupts the carbon black’s conductivity, thereby making the system an insulator and no longer a conductor, as illustrated in Figure 81 [195]. This prevents the system from continually generating heat, but able to maintain its heating capability at a given temperature and be self-regulating. Thermoplastic polymers are used in making PTC heating elements in tape form [196, 197]. EB crosslinking of the thermoplastic

prevents the plastic from distorting as the melt transition is approached and enables the PTC device to be cycled many times near its transition temperature and become current limiting [198, 199]. A number of EB crosslinkable thermoplastics, as listed in Table VII above, can be used so that the transition of the self-regulation of the PTC material can be specified. This provides a range of controlled heating temperatures. Such self-regulating tapes, illustrated in Figure 82, can be wrapped around pipes to prevent fluids from freezing or to facilitate liquid transport by using heat to lower viscosity. PTC systems have been incorporated into complex heat shrinkable products to both activate adhesive systems and shrink the product [200].

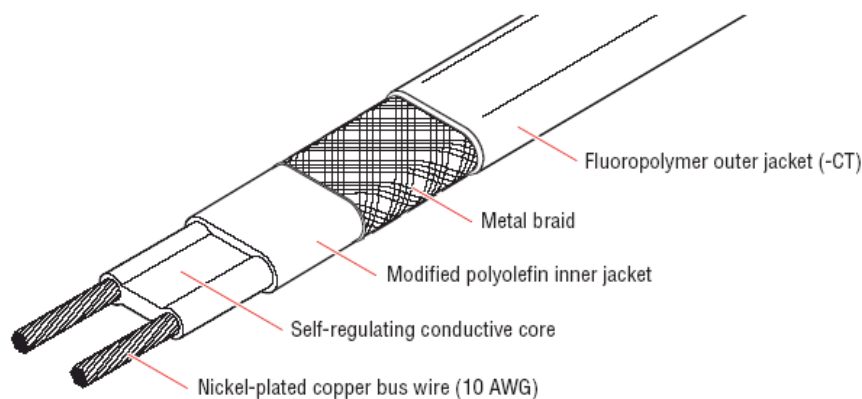
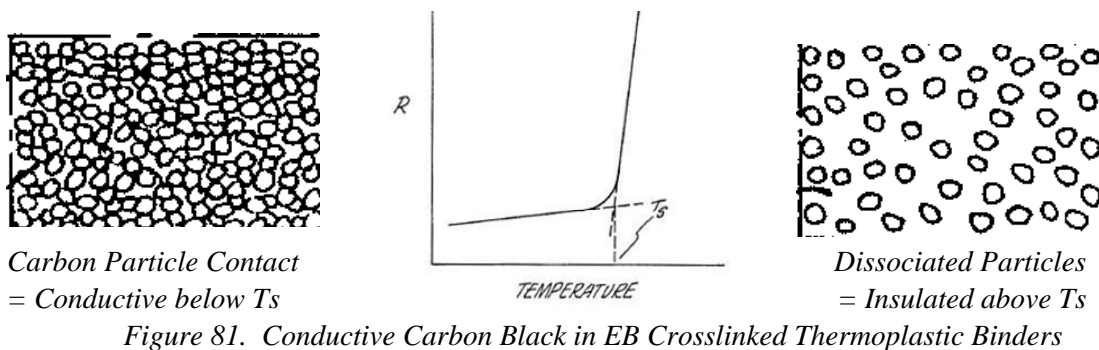

Figure 82. Self-limiting Heating Cable

Another mode in which PTC self-regulating materials have been used is as circuit limiting switches or self-repairing fuses. The Polyswitch™ is used to control the heating of more conventional resistance heaters by being wired in series with the heater and immersed in what is being heated, such as a water bath [201, 202]. At a specified, controlled temperature, the switch will stop being conductive and limit the heating. PolySwitches, shown in Figure 83, also serve as self-healing fuses when incorporated into electronic or electrical circuits, preventing resistance over-heating.



Figure 83. PolySwitches

5.7. Inks, Coatings and Adhesives

The early use of electron beam curing for coatings was stimulated by the work of Bill Burlant at the Ford Motor Company. In the early 1970s, Burlant showed that EB cured coatings on plastic components could be produced at 750 times the speed of conventional paint or coating application and drying techniques [71, 72, 203]. Figure 84 shows some of those automotive parts with coatings which were then cured by electron beam processing [77]. Although the interest at Ford never developed into a sustained commercial practice, EB curable coatings have since found major market uses on a variety of substrates, such as paper, wood, metals and plastics.

An advantage to EB curing and crosslinking of coatings is that pigmentation does not interfere with the crosslinking process as it does with the use of ultraviolet radiation. Likewise, metallic pigments can be used. Figure 85 shows a pigmented metal coating that was cured with low-energy EB. Figure 86 shows a white EB cured coating that withstood 1000 hours in a salt spray test. Figure 87 shows that such coatings could tolerate subsequent bending as required for metal coil coatings [204, 205]. Figure 88 shows a pigmented coating that was vacuum coated onto tubular aluminum and cured using four low-energy EB units positioned around the rigid tube [206]. Figure 89 shows an array of colors on metal test panels that were coated and then cured with low-energy EB.

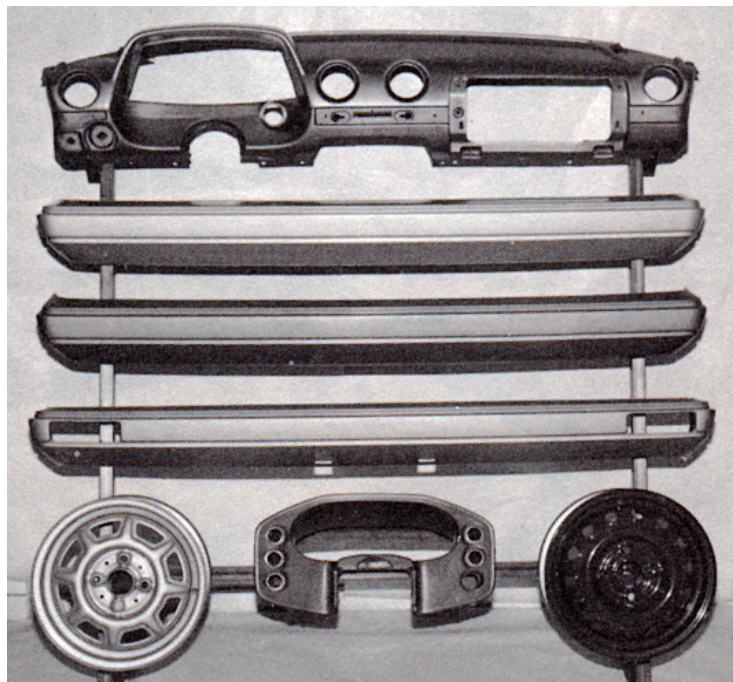

Figure 84. EB 3D Cured Auto Parts ~1980

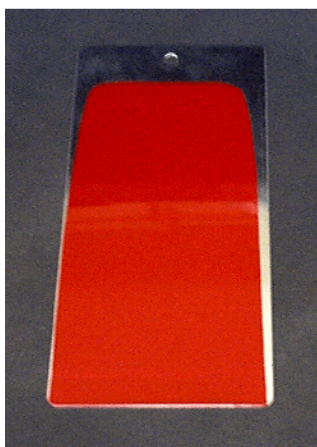

Figure 85. Pigmented Coating Cured with Low-Energy EB



Figure 86. EB Coating after 1000 Hours Salt Spray



Figure 87. EB Coating after Mandrel Bend Test



Figure 88. EB Cured Coating on Tubular Aluminum



Figure 89. Diverse Array of Low-Energy EB Cured Pigmented Coatings

The use of radiation curing for printing inks was pioneered by Dan Carlick of Sun Chemical (now part of Dai Nippon) [207]. Electron beams are more often used with wide-web presses for high volume production and for printed items that require outstanding graphics and color highlights. Electrons have the ability to penetrate pigments, whereas UV does not. EB ink formulations tend to be considerably less complex than UV formulations. Because electron beam processing is not a thermal means of energy transfer and takes place at near ambient temperatures, EB “drying” of inks can be used on heat sensitive substrates, such as plastic films, minimizing concerns over film distortion. Electrons generate free radicals in vinyl terminated monomers leading to double bond opening, polymerization and crosslinking. A balance of properties, especially for over-print materials, is attained by using oligomers which are terminated with acrylate functionality. Familiar ink and coating materials, such as polyesters, polyurethanes, epoxies and acrylates themselves are used in developing reactive oligomers which enhance the flexibility and other properties of the cured and crosslinked system. Since there are no extractable initiators used in EB curable inks and over-print systems, Sun Chemical has been able to develop over-print materials that are compliant with US Food & Drug Administration regulations for direct food contact [208]. Use of such systems could replace film laminates used atop printed materials to prevent leaching of extractables for compliance with direct food contact regulations.

The major suppliers of monomers and oligomers for inks, coatings and adhesives have addressed issues of toxicity, Clean Air Act compliance, food contact and a host of other areas

of concern in contemporary industry. These have been driving factors in changing the portfolio of materials available to formulators over the past several decades. As noted above in Table I, the energy required to convert formulations of inks, coatings or adhesives using electron beams is significantly less than that to use alternative drying systems, even with what are called “high solids” content products. Besides eliminating volatile organic emissions (VOCs), EB curing also lessens potential greenhouse gas emissions. Table X compares an EB cured system with that of a high solids solvent system in which solvent incineration would be used to dispose of volatiles [205, 209].

Table X. Comparison of Solvent Based Drying with EB Curing

System:	Solvent	EB Curable
Coating solids concentration:	60%	100%
Dried coat weight, g/m ² :	20 g	20 g
VOCs/m ² , grams: (0.9 density solvent)	12 g	0 g
Total force air system energy demand, kJ/m ² :	328 kJ	NA
(calculated 27.3 kJ/g to dry)		
Total EB energy demand, kJ/m ² :	NA	0.86 kJ
(30 kGy or 0.030 kJ/g at 70% electrical input to effective EB)	~3,700,000 kJ	~9,600 kJ
Total energy demand/hour		
Total energy demand/hour:	1,030 kWh	2.67 kWh

Greenhouse gas emission potential

CO ₂ from solvent combustion:	37 g/m ²	none
Facility CO ₂ emission potential:	416 kg/h	none

Low-energy EB processing is used in making laminates of thin films or thin film overlays. Higher energy EB or even X-rays can be used to set the adhesive bonds between thicker substrates. Materials with very different coefficients of thermal expansion can be bonded with EB curable adhesives without creating the interfacial strain generated when using thermal curing. Pressure sensitive adhesives (PSAs) are also cured using EB. Beiersdorf and the 3M Company use this approach with low-energy electron beams. Formulated PSAs based on natural rubber or similar diene polymers EB crosslink at high product through-put rates [14]. Acrylic adhesives often based on butyl (C₄) and 2-ethyl hexyl acrylate (C₈) monomers and combinations thereof provide transparent adhesives. When using such monomers by themselves, attention must be given to dose-rate effects in order to avoid unwarranted chain termination, which would reduce the molecular weight of the cured material [210, 211]. The propagation step of such in-situ polymerization/crosslinking reactions can be extended by reducing the dose-rate and increasing the residence time under the EB unit [212].

5.8. Hydrogels

Another technology based on liquids that are coated and then irradiated is the manufacture of hydrogels. Radiation crosslinked hydrogels are based mainly on polyethylene oxides (PEO) dissolved at relatively low concentrations in water, ~4% to ~10%. Modest radiation exposure is needed to form a gel, <10 kGy. Polyethylene glycols (PEG), polyvinyl alcohols (PVA) and polyvinylpyrrolidone (PVP) have also been used in these systems. PVP is also very radiation responsive. Because of the excellent radiation response of the polymers used in making hydrogels, low-current research type accelerators, as Van de Graaffs, can be used in their manufacture [139, 140, 141]. Gels as thick as 2 mm are produced. These materials have found use as wound dressings and for burn treatment. Because of their biocompatibility, there is considerable activity in evaluating hydrogels as transdermal drug delivery systems and as drug delivery systems that can be inserted into the body. Figure 53 above presents the structure for the widely used polyethylene oxide (PEO) which is the basis for most hydrogel technologies. This ethylenic structure is very amenable to radiation crosslinking. Figures 90 and 91 show hydrogel dressings and their use in burn treatment respectively. Hydrogels are also being evaluated to provide compliant surfaces in prosthetic devices [213].



Figure 90. Hydrogel Dressing



Figure 91. Hydrogel Used in Burn Treatment

5.9. Medical Device Sterilization

The Johnson & Johnson Company (J&J) pioneered the radiation sterilization of medical devices in 1956 [214]. J&J's Ethicon Division inaugurated radiation sterilization using electron beam processing to sterilize absorbable sutures [215]. A very diverse range of medical devices are sterilized using EB processing. Figure 92 shows a wide array of these materials. Table XI lists examples of the diverse types of medical products that can be subject to radiation sterilization [122]. Three issues are of concern for using electron beams or X-rays derived from electron beams for medical device sterilization: 1) the materials used in the manufacture of the device; 2) when in the manufacturing operation will the device be exposed to radiation sterilization; and 3) the amount or degree of exposure needed to attain “sterility assurance” levels. As noted above, the studies upon which “sterility assurance” levels have been adopted are almost exclusively based on low dose-rate gamma-ray irradiation [151]. While X-rays are an alternative to radioactive gamma-ray sources, they are at higher dose-rates, albeit not as high in dose-rate as EB (Table III) [1]. Studies involving EB have shown a dose-rate dependence of “cell-death” or the lethality of radiation exposure, wherein higher

dose-rates have greater lethality [154, 155, 156, 157, 158]. The potential for the reduction of the dose-to-kill exists with EB and X-ray processing.



Figure 92. Diverse Disposable Medical Devices

Radiation sterilization is also used, but to a much lesser extent in terms of product volume, for non-disposable items, such as hip and other joint replacements. These implants are made from combinations of metals and plastics. The biocompatibility of various materials and the use of radiation to enhance such is another area of study, but not dealt with herein.

Table XI. Medical Disposable Articles Sterilized by Ionizing Radiation

Syringes	Absorbents
Catheters	Gloves
Drains	Surgical gowns and drapes
Tubing	Hand towels
Urine bags	Beakers and lab ware
Drain pouches	Petri dishes
Bandages	Culture tubes

When ionizing radiation is used for sterilization of medical devices, the compatibility of all of the components has to be considered. Ionizing radiation not only kills micro-organisms but also affects material properties. Medical devices are made of many different materials, some of which are metals, but most are non-metals, such as formed polymers, composite structures and even ceramics. If metals are part of a device, such as the needle of a syringe, then there must be sufficient EB energy so as to penetrate the higher density metal or the product orientation under the beam must be chosen to adequately expose the entire article.

Plastics such as polyvinyl chloride (PVC) are used to replace glass in some products, such as containers for saline solutions, as shown in Figure 93. However, because of concerns over the discoloration of PVC when exposed to radiation and over the leaching of plasticizers used to impart flexibility in PVC formulations into the blood, alternatives have been developed to replace the use of PVC in medical devices. These newer materials are based on polyethylene blends that include the optically clear metallocene catalyzed polyethylenes

(mPE) or polypropylenes (mPP) and laminates of these [119]. Such products, as shown in Figure 94, remain clear upon exposure to electron beam and X-ray sterilization. A properly formulated PE material will also be enhanced by radiation exposure while not losing flexibility.



Figure 93. Flexible PVC as a Replacement for Glass



Figure 94. Polyolefin Laminate as a Replacement for Flexible PVC

The complexity of disposable medical devices is illustrated by the construction of a syringe, as shown in Figure 95. Disposable syringes of various sizes can consist of: a) an injection molded plastic barrel; b) an injection molded plastic plunger; c) a rubber ring at the base of the plunger to preclude air and assure pressure on the liquid in the syringe; and d) a metal hollow needle bonded into the base of the plastic barrel. Specially formulated radiation tolerant polypropylenes as discussed above should be used for the barrel and plunger [121].



Figure 95. Disposable Plastic Syringes

Rigid transparent medical devices can be molded from radiation tolerant plastics based on polycyclic structures, such as polystyrene (PS), polycarbonate (PC) and polyethylene terephthalate (PET). The manufacturers of PC and PET have developed specialty grades that minimize any discoloration from radiation exposure. Figures 96 and 97 show devices that are made from these rigid transparent plastics [122].



Figure 96. PS Drainage Monitoring Unit



Figure 97. Disposable PC Cartridge for Hyperbaric Chamber

Flexible tubings and other products for medical devices are also made out of silicone elastomers, as shown in Figures 98 and 99. In general, these materials are radiation tolerant.



Figure 98. Various Silicone Rubber Medical Products

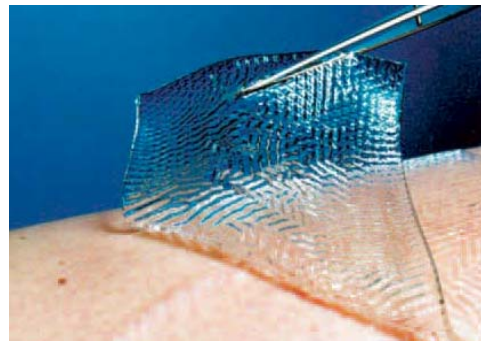

Figure 99. Non-adherent Silicone Wound Dressing

In designing medical devices, product engineers must be attentive to the effects of radiation on various components. For relatively low-cost disposables, combinations of polyethylenes and polypropylenes, in particular the metallocene catalyzed mPE and mPP, can impart flexibility and optical clarity. Radiation tolerant polypropylene formulations should be used for items requiring some rigidity, such as syringe components. Engineering or rigid plastics such as polystyrene, polycarbonate and polyethylene terephthalate (PET) or polybutylene terephthalate (PBT) can be used. PVC and polysulfones which discolor under irradiation as well as polyvinylidene chloride (PVdC), which darkens and chain scissions, should be avoided [122].

Electron beams were first used at the very outset of irradiation sterilization, going back into the 1950s. 10 MeV high-energy accelerators have been used for many decades for sterilizing packaged medical devices. Both in-house and service center facilities use this type of equipment in established manufacturing processes. Some mid-energy accelerators at 3.0 to 5.0 MeV are also used for medical device sterilization. Many packaged devices have a low bulk density so that the penetration of electrons is sufficient. If needed, packages can be irradiated from opposite sides, thereby increasing the beam penetration to 2.4 times that of the equal-entrance—equal-exit depth-dose profile for the beam energy itself, see Figure 8. An alternative to gamma radiation is electrically sourced X-radiation [1]. Figure 10 shows that

X-rays have the similar effective penetration as gamma rays which are derived from radioactive sources, mainly cobalt-60. X-rays have slightly higher dose-rates than gamma rays and may not be as deleterious on some polymers, formulated PP for example, as gamma ray radiation [121].

To attain more uniform dose distributions in large pallet loads of packaged products, a turntable can be used to rotate the pallet in front of a tall, collimated X-ray target. This system, conceived and patented by MDS Nordion Incorporated and licensed to Ion Beam Applications, is called the Palletron™. Figure 100 illustrates the Palletron in front of a tall X-ray target equipped with thick steel collimators on each side to limit the width of the X-ray beam [216, 217].

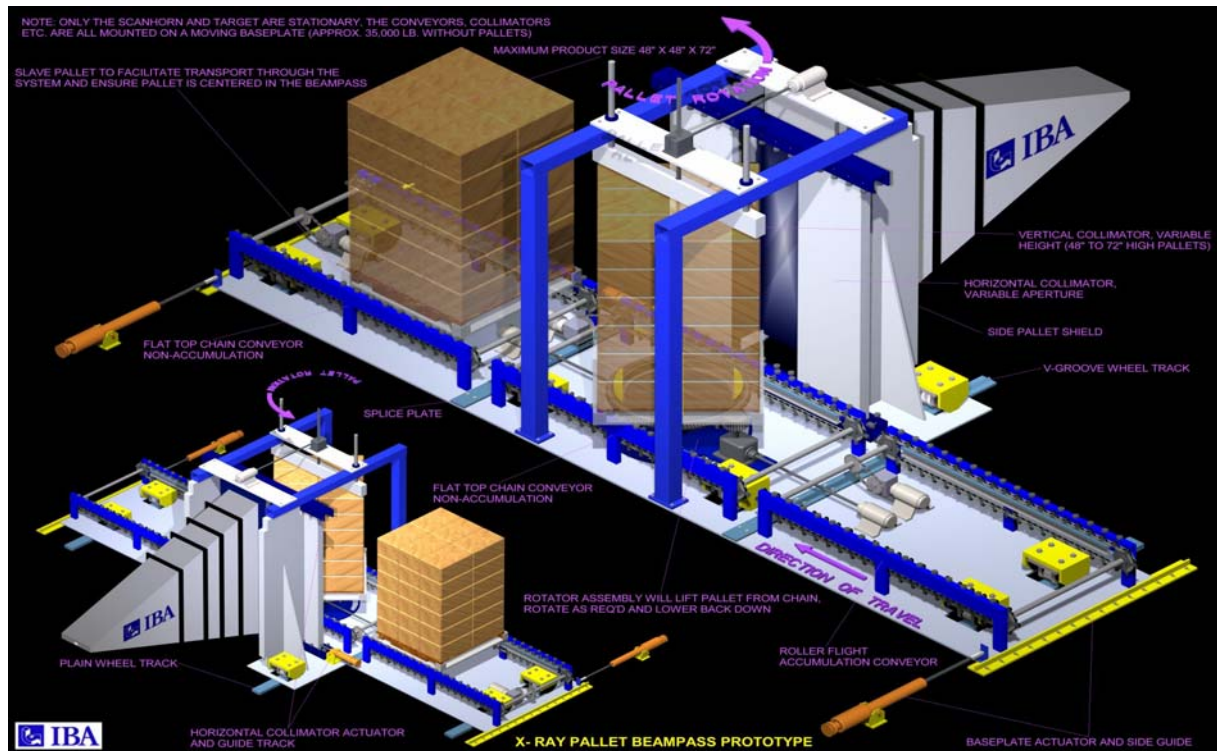

Figure 100. Rotation of Product on a Palletron in Front of an X-ray Target

The dose distribution in a rotating pallet irradiated with a scanning, collimated X-ray beam can be calculated with a Monte Carlo code. This will indicate the energy deposition levels so that one can estimate and thereby minimize the differences between the maximum dose (D_{max}) and the minimum dose (D_{min}) and attain an acceptable dose uniformity ratio (DUR). Figure 101 shows the results of the three-dimensional Monte Carlo calculation of DUR for a cylindrical object rotating in front of a collimated X-ray target which is intercepting a 5 MeV electron beam. In this example, the diameter of the cylinder is assumed to be 80 cm and the average product density is 0.8, which is more apropos for food products than medical devices. The purple colors on the top exterior and on the interior indicate that the surface dose will then be equal to the dose at the very interior of the rotating container. Parameters, such as distance from the X-ray target, the width of the collimator (A), or the width of the packaged material (D) can then be adjusted to assure this dose uniformity [217].

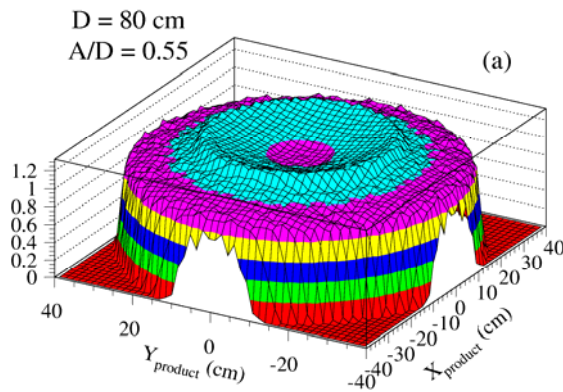

Figure 101. Monte Carlo Illustration of Uniform Dose Distribution for Rotating Product

5.9.1. Regulatory Compliance for Sterilization

For medical device sterilization a quality assurance level (SAL) of 10^{-6} is usually required. This means that there is a probability of less than one in a million of any one article having any bioburden on it. Industry associations, such as the Association for the Advancement of Medical Instrumentation (AAMI) and the International Standards Organization (ISO) have prescribed dose setting methods that establish dose based on bioburden and selected SAL levels [218]. For example, AAMI/ISO 11137-2006, *Sterilization of health care products -- Radiation -- Part 1: Requirements for development, validation and routine control of a sterilization process for medical devices*, covers this topic [151]. In some instances, such guidelines have been codified as in British Standard EN 552:1994 *Sterilization of medical devices. Validation and routine control of sterilization by irradiation*. Because of the irregularities of the geometries of products being sterilized by EB or even by X-ray or gamma rays, this implies that there will be some higher dose exposure, somewhere within the product, in order to attain this minimum throughout a package of medical devices. Since most medical devices are produced in clean rooms which have highly filtered air and where equipment operators must be gowned or dressed and pass through some inter-lock for decontamination, the actual level of any bioburden on a medical device is exceedingly low. It is difficult to assess this actual bioburden on any given lot of products produced under such clean room conditions. An implication of this is that the 25 kGy exposure is more than likely excessive. Such excess leads to the need for more radiation tolerant materials which are more costly, because they are specialty materials. Bioburden testing would enable a producer to validate a process in which a lower dose is used. It should be borne in mind that data underlying the prescribed SAL of 10^{-6} is derived from the semi-logarithmic linear extrapolation model, as shown in Figure 57.

The general recommended procedures to follow are: product selection, microbiological testing, product irradiation, dose setting using bioburden (Method 1), dose setting using fraction positive information from incremental dosing to determine extrapolation factor (Method 2), sterilization dose auditing. Once the sterilization dose has been established, periodic audit is required to reaffirm the sterilization dose. The periodic audit is performed by exposing 100 product samples to a dose that is expected to achieve a sterility assurance level (SAL) of 10^{-2} and subsequently testing the samples for sterility. For products in regular production, an audit should be performed at three month intervals to detect changes in the bioburden that could require an increase in the sterilization dose. The simplest case is when

the sterilized product is homogenous, small in size, inexpensive and when the sterilized batches are large and frequently irradiated. Petri dishes are an example of such a product which is manufactured in well known, stable conditions and the bioburden (population of viable microorganisms on a product) can be easily determined. A more complicated case is when the cost of product unit is high and the production scale is small, then the cost for performing sterilization dose auditing is large.

Dose setting is a specific feature of the radiation sterilization process. Many medical devices manufacturers already employ Good Manufacturing Practices (GMP), in particular document control, inspection and testing, validation of the process, commissioning of the plant and microbiological monitoring. Basic requirements are directly related to quality management (quality assurance and quality control), personnel (qualification and training, hygiene), equipment and premises (production area, storage area, quality control area, ancillary areas), documentation (specifications, processing and packing instructions, procedures and records), production, contract manufacture and analysis, complaints and product recall, and self inspection [219].

5.9.2. In-line Medical Device Sterilization

In-line sterilization of packaged medical devices was explored in the late 1990's. RPC Industries produced the Minilac™ system based upon a 2.0 MeV, 10 kW linear accelerator, as shown in Figure 102. The entire system occupied 37 square meters of floor space and was shielded by a 0.5 meter thick concrete vault. Product was fed via a conveyor system into the vault, going under the beam, exiting the vault, and then packed into boxes for shipping, as shown in Figure 103. The Minilac could handle the sterilization of packaged devices in less than five minutes and keep pace with packaging operations [83, 220]. The use of the Minilac was approved by the Association for the Advancement of Medical Instrumentation (AAMI) and it complied with standards set by the International Organization for Standardization (ISO). However, only one such unit was ever built and installed in Thailand.

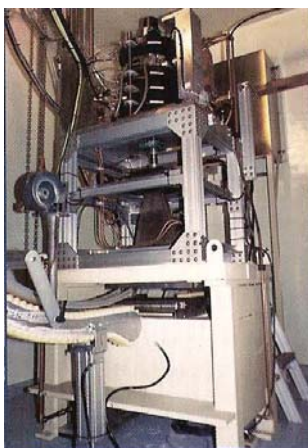

Figure 102. 2.0 MeV Linac



Figure 103. Packaging Sterile Product

In 2008, GETINGE LINAC developed stand-alone medium energy (3 to 5 MeV, 5 kW) self-shielded in-line EB equipment that provides terminal sterilization of packaged medical products or sterile transfer into an aseptic product filling system. The entire STERBOX™ system (except for the electrical cabinet and cooling system) is installed inside a stainless steel housing, which encases the lead shielding, and has a footprint less than 20 square meters, as

shown in Figure 104. This permits the entire unit to be positioned inside a GMP cleanroom. In-line sterilization is accomplished at the same speed as production and packaging processes. This reduces the logistics and storage costs entailed with trans-shipment of product to outside sources for sterilization [221, 222, 223]. An installed STERBOX system has been validated by the US Food and Drug Administration (FDA). For sterilization of higher density product, the STERBOX Twin contains two 5 MeV, 5 kW accelerators which enable two-sided treatment of products to be conducted in a single pass. The 2.4 multiple for two-sided irradiation is illustrated in Figure 8.



Figure 104. Self-shielded In-line Medium Energy System for Device Sterilization with Mobile Section (stainless steel housing and lead shielding) Open

5.10. Food Irradiation

Food irradiation was one of the very first uses of Roentgen's discovery of X-rays. In 1896, F. Minck published a paper describing the use of these rays to kill microorganisms [224]. In 1905, Hugo Lieber received a US patent on using irradiation to preserve food, albeit at that time, the exact effects of irradiation and its properties were not yet understood [225]. In 1906, Joseph Appleby and Arthur John Banks obtained a British patent for treating food with X-rays [226]. Work at the US Department of Agriculture (USDA) in 1921 under B. Schwartz showed that X-rays could kill *Trichinella spiralis* in pork [227]. The preservation of ground beef by irradiation was investigated during World War II. In 1953, the US launched a major effort on food irradiation [228]. Since then there has been an evolution in the approbations and approvals of the use of irradiation for eliminating pathogens from food and for disinfestation of fruits and vegetables. Despite the proposed reduction in labeling and acceptance by the public, who have had the opportunity to consume irradiated food, the major food processors have been reluctant to adopt this process technology.

The industrial high-energy electron beams (10 MeV) described above (Figure 13, 14 and 15) have a history of successful use in irradiating food and foodstuffs to eliminate pathogens [84, 85]. X-rays derived from 5.0 or 7.5 MeV beams (Figure 23 and 24) can be used, as have nuclear gamma-ray sources of comparable penetration (Figure 10) [229]. The efficacy, minimal effect on nutritive value and general safety of irradiating food has been demonstrated over and over again. The World Health Organization (WHO) has long been on record as supportive of this method for processing food [230, 231]. The process systems for attaining acceptable dose distributions with packaged medical products can also be used for food irradiation (Figure 100 and Figure 101).

However, there is a lack of coherence in the regulatory postures between medical device sterilization, which requires a dose minimum, and food irradiation, where a dose maximum is called for. With food, over-irradiation is of concern lest food be altered to affect taste and quality. Yet the pathogens found in the food supply chain, such as *Listeria*, *Salmonella* and *Escherichia coli*, have caused illnesses and deaths and resulted in major recalls of foods by producers, whereas the probability of any pathogens on medical devices made in clean rooms remains very low. Figures 105 and 106 show the US FDA maximum allowable doses for some of the food items that can be and have been irradiated. Irradiated spices are widely used in processed foods. These ingredients, which are used for flavor enhancement, cannot tolerate other forms of pasteurization, such as thermal or chemical processes.



Figure 105. Red Meat (4.5 kGy max.) and Poultry (3.0 kGy max.)



Figure 106. Spices (30 kGy max.)

As in medical device sterilization, to disinfect, to pasteurize or to sterilize means to scission the DNA of the pathogen or infecting organism. As the techniques in molecular biology advance, the use of surrogates such as dosimeters or even the use of traditional bioburden testing, which takes days for cultures to grow, could be replaced. If the DNA of, for example, *E. coli* scissions to a point where it will not replicate in a PCR system, then the *E. coli* has been effectively killed. Process settings of beam current and under-beam transport speed could then be set based on a new paradigm of testing for bioburden survival. Whether regulatory regimes can keep pace with such developments will be an issue for the future [232].

5.10.1. Regulatory Compliance for Irradiated Food

A joint committee of the International Atomic Energy Agency (IAEA), the World Health Organization (WHO) and the Food and Agriculture Organization (FAO) of the United Nations on the wholesomeness of irradiated food announced that food irradiated below 10 kGy is wholesome in 1980. The Codex Alimentarius approved a regulation to accept foods irradiated lower than 10 kGy in 1983, and further approved foods irradiated at higher than 10 kGy if so warranted in 2003. This is contained in the FAO WHO Codex General Standard for Irradiated Foods Codex Stan 106-1093, rev.1-2003. This also calls for the proper labeling of irradiated food. There is an internationally recognized symbol for irradiated food, Figure 107.

There are region by region and country by country variations on the regulatory compliance of foods and there is not a broad international acceptance of the recommendations of the WHO and FAO. In the US, for example, the FDA has taken a food category-by-category approach: a) a maximum absorbed dose of 4.5 kGy for fresh red meat products; b) a maximum absorbed dose of 3.0 kGy for poultry; c) a maximum absorbed dose of 1.0 kGy for irradiating fruits and vegetables; and d) a maximum absorbed dose of 30 kGy for spice irradiation [233].

In Japan, the irradiation of potatoes for sprout inhibition after harvest was approved in 1972. The commercial irradiation of potatoes has been conducted since 1974 and now on a scale of ~10,000 tons per year. Nonetheless, the Ministry of Health and Welfare of Japan has not approved any other irradiated food items for public consumption and its regulations are not harmonized with Codex regulation.

In the European Union, directives are in place to guide member states in formulating laws, rules and regulations on food irradiation, such as Directives 1999/2/EC and 1999 /3/EN and Directives 89/397/ECC and 93/99/EEC. However, there remain country by country variations as to which particular irradiated foods can be consumed by the public.

Given the outbreak of illnesses by consumers brought on by food pathogens as *Escherichia coli* (*E. coli*) and *Salmonella* and the consequent food product recalls of meat and vegetables, the regulatory posture within the US, for example, is in a state of flux. The reluctance of the major food processors and distributors to adopt the radiation process, more than any consumer resistance, remains a market barrier.



Figure 107. Symbol for Irradiated Food

5.11. Food and Medical Product Packaging Decontamination

An emerging use of low-energy electron beams is to decontaminate the surfaces of packaging materials that can be used either for food products or for medicinals. It is desirable to treat such packaging materials before they enter a clean area for aseptic filling, as for foods and beverages, or within an aseptic area itself for filling with medications [234, 235]. These processes involve EB units in the 100 to 250 keV range. The thicknesses of the traditionally used bioburden strips or dosimeters pose problems with these low beam penetrations. This may be an area in which the techniques of molecular biology might be more applicable in that only very thin smears, say $\sim 10 \mu\text{m}$, of the bioburden would have to be used.

Figure 108 shows a complete pharmaceutical filling line with a self shielded low-voltage EB system positioned in-line immediately before an aseptic filling and packaging system for medicinals. The STERSTAR™ system, developed by GETINGE LINAC, decontaminates the package surface. Figure 109 is a schematic of the triangularly positioned 200 keV EB units [221, 222, 236, 237, 238, 239].



Figure 108. STERSTAR™ System for In-line EB Surface Decontamination

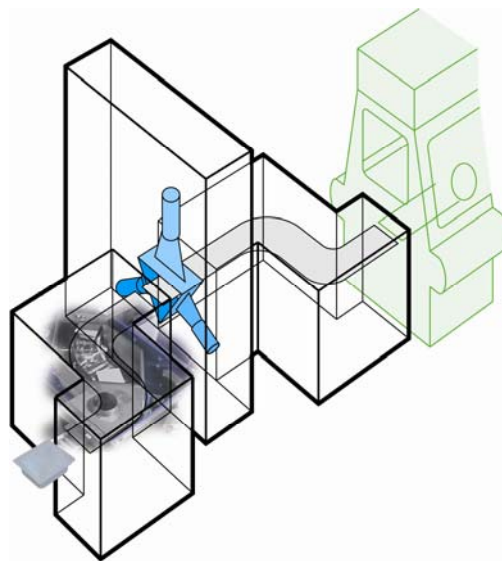

Figure 109. Schematic of Tri-angulated 200 keV EB Accelerators for Transfer into an Aseptic Filling Line

6. OTHER APPLICATIONS AREAS

Most of the accelerators used in industry are used to enhance the properties of plastics and elastomers or to convert polymeric precursors that are applied as liquids to yield cured inks, coatings and adhesives, and hydrogels. All require radiation crosslinking in order to form materials of commercial interest and value. With EB or X-ray sterilization, plastic components ought to be radiation tolerant, not discoloring nor degrading under the exposures needed to eliminate bioburdens. Besides the major end-use applications highlighted above, there are others worth noting. These are proven and effective industrial EB processes but are limited by the size of a given market or by still developing commercial acceptance.

6.1. PTFE Degradation

Polytetrafluoroethylene (PTFE) chain scissions upon exposure to electron beam irradiation. After reducing the molecular weight, this highly crystalline polymer can be ground into fine powders (2 μm to 20 μm). Small amounts of these powders (2% to 5%) are incorporated into printing inks and coatings to act as internal slip additives. This prevents very decorative printing from abrading other printed material packaged next to it in a container. Doses of 600 kGy or more are needed for this application [240, 241, 242].

6.2. Water Pipes and Tubing

There is a growing commercial acceptance of the use of EB to crosslink polyethylene based pipes and tubing that can be used for transporting water, known as PEX-C. The same type of under-beam handling equipment that has been used for wire and cable (Figure 71) is used for the smaller diameters that can be put on reels as tubing. Large diameters and long lengths of PEX-C piping are being produced using a specialized under beam handling system in a very long vault. Figure 110 shows 12 meter long PE pipe readied for entry into a customized vault. Tubing made from laminates of polyethylene and aluminum is also now being used for water distribution [243, 244].



Figure 110. 12 Meter PE Pipe for EB Crosslinking

6.3. Battery Separators

Electron beam crosslinking of polyethylene films to an exceedingly high crosslinked density followed by EB surface grafting of acrylic acid creates films that can control the ion flow between the cathode and anode of small lithium or other ion based batteries [245, 246, 247]. These films have significantly longer useful life than films produced by other methods.

6.4. Filter Membranes

Surface grafting is used to modify the hydrophilicity or hydrophobicity of filter membranes. Micro-porous polyvinylidene fluoride (PVdF) films are used. Graft monomers are selected based upon the desired end-product use [248].

6.5. Semi-conductor Treatment

Diodes and transistors are irradiated using EB to induce permanent or transitory modifications in the electrical properties of these devices. Absorbed doses around 100 kGy are used in these applications. Property modifications of these components, such as current (direct and reverse), capacitance, switching speed and resistance are effected. Tests are based on the direct measurement of the current as a function of voltage before and after EB processing. Results show that the alterations in the drift speeds of the load carriers cause reductions of the reversal recovery times for these devices. Thus, semiconductors become more suitable for applications in high frequency and high power circuits [249, 250].

6.6. Gem Stone Irradiation

Electron beam irradiation will alter the color of some gem stones so as to enhance their commercial value. Topaz, rubelita, quartz, citrine, ametista and even diamonds have been irradiated for this effect. Since very high doses are often required, care is taken not to over-heat the gems while they are being irradiated. Also, some gems must be set aside for weeks or even months to allow for the decay of any induced radioactivity, as small as it may be [251, 252]. Figure 111 shows the enhanced brilliance and color of some irradiated gems.



Figure 111. Irradiated Gem Stones

7. EMERGING APPLICATION AREAS

7.1. Cellulose Degradation for Ethanol/Biofuel Production

There is interest in converting cellulose and sugars, including sugarcane bagasse, into ethanol in order to avoid using agro-products, like corn, that can also be used as food,. The conventional hydrolytic breakdown of these renewable resources generates contaminated water and undesirable toxins that interfere with fermentation. Pretreatment with EB facilitates the enzymatic conversion of these materials and produces alcohol without diverting any items from the food supply chain [253, 254].

7.2. Cellulose Degradation for Paper and Viscose Production

Large scale testing has been conducted to see if EB degradation of the cellulose in wood chips would enhance the digestion rate of such for paper or viscose manufacture. This promising technique has not been adopted on a commercial scale [142, 143, 144, 145, 255, 256].

7.3. Water Treatment

Studies have shown that the pathogens found in sewage sludge can be eliminated by EB treatment [257, 258, 259]. Likewise, undesirable halo-carbons found in waste-water can be decomposed by EB [260, 261, 262]. Full scale demonstration facilities have been constructed as well as transportable EB systems on vans [263]. While these transportable systems have not met with commercial acceptance, there is renewed interest in using such EB systems to break down pollutants in wastewater from cleaning refinery vessels [252]. An upward flowing wastewater system was developed to use the entire beam output in treating the water [264]. A similar system is used in a full scale EB water treatment facility in which an accelerator with three beam lines irradiates under-beam troughs to eliminate the residuals from a textile manufacturing plant [265, 266]. Figure 112 shows the beams in operation (with some water splashing onto the camera lens).

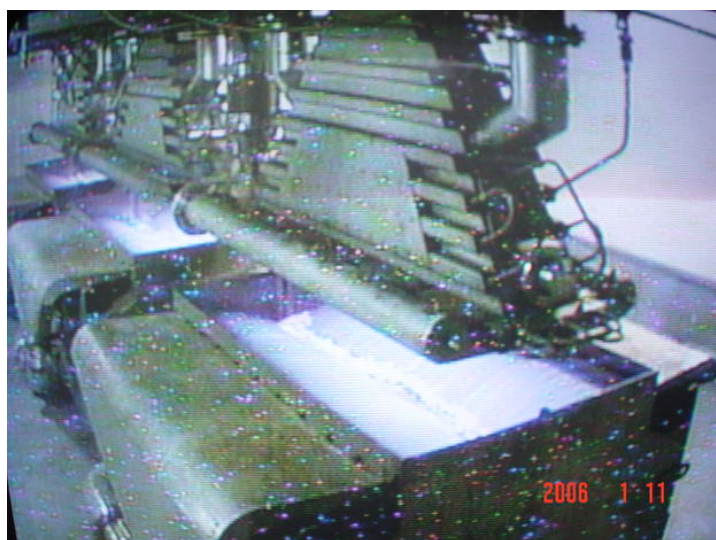

Figure 112. Water with Residual Dye Contaminants being EB Treated

7.4. Stack Gas Treatment

Based on discoveries made in Japan in the early 1970's, EB processing can be used to eliminate both sulfur dioxide (SO₂) and nitrous oxides (NO_x) from the combustion by-products of fossil fueled electric power plants [267, 268]. High-current, mid-energy (700 keV) EB units have been used in a full scale demonstration facility. Two EB units are used on each of two parallel flue gas chambers. The EB process is unique in that it can eliminate both of these combustion gases. Alternative systems, like wet scrubbers, can handle SO₂ but not NO_x. Injection of ammonia into the gas being treated results in a powdery precipitate of mixed sulfur and ammonium nitrates that can be collected and used as fertilizer [269, 270, 271, 272]. Figure 113 shows EB unit scan horn entering one flue gas chamber. Figure 114 shows the double beam window used to prevent corrosion of the beam window itself.



Figure 113. Flue Gas Irradiation Chamber with EB Unit



Figure 114. Interior of Double Beam Window in Flue Gas Chamber

7.5. Exhaust and Gaseous Treatment

The use of EB to eliminate contaminants in other gaseous systems, such as from emissions found in highway tunnels or organics from industrial facilities, has been explored. Some processes remain in the pilot or feasibility stage [273].

7.6. Composite Curing

EB has been used to cure the matrix materials in carbon fiber composites (Figure 16). Recent studies have shown that such matrices can also be cured in a mold to produce shaped articles, such as vehicle fenders, using X-rays wherein the X-rays penetrate through molds and the product shape. EB and X-ray curing are not thermal processes so residual internal strain within a composite due to differences in thermal expansion coefficients and longer exposure times at high temperatures needed in the thermo-chemical processes are eliminated [274, 275, 276, 277]. Figure 115 shows an X-ray cured carbon fiber sports car fender that was cured in a vacuum bagged polyester mold. Figure 116 shows a fender for a wide-wheeled motorcycle that was also X-ray cured within a mold. Both exhibited Class A surfaces and excellent fiber wetting and final composite properties.

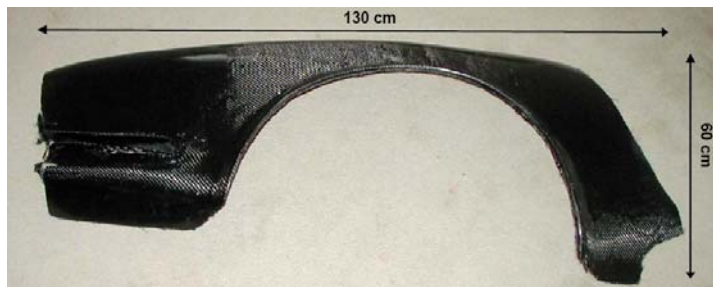

Figure 115. X-ray Cured Carbon Fiber Composite Sports Car Fender

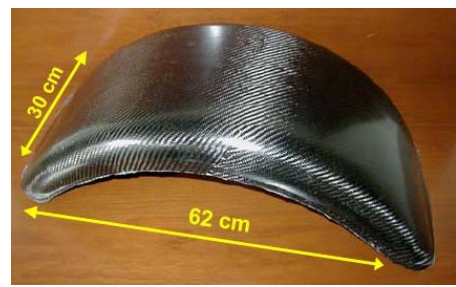

Figure 116. X-ray Cured Carbon Fiber Composite Motorcycle Fender

7.7. Carbon Fiber Modification

Carbon fibers used in composite manufacture have been treated with EB in order to enhance the adhesion of the matrix to the fiber. Improvements in mechanical properties of cured composites were observed irrespective of the initial sizing on the fiber [278, 279, 280, 281].

7.8. Silicon-Carbide Fiber Manufacture

Silicon-carbide (SiC) fiber is made by first extruding polycarbosilane and then irradiating fiber strands with EB to crosslink the fiber. The conventional process involving heating the fiber produces a fiber with lower heat resistance due to the presence of oxygen. EB crosslinked SiC fiber can maintain high tensile strength up to 1700°C while thermally crosslinked SiC maintain strength only up to 1200°C. This type of ceramic fiber is of interest in some space applications [282].

7.9. Fuel Cell Membranes

Proton exchange membranes (PEM) used in fuel cells are being developed based upon the radiation grafting of styrene onto polymer films, such as PTFE, PVdF, PE and PP using low-energy EB systems. The grafted surface is then sulfonated. These films have excellent mechanical properties and the desired proton conductivity [283, 284, 285].

7.10. Fuel Cell Catalyst Modification

Platinum (Pt) and Ruthenium (Ru) nanoparticles are prepared by submitting water/ethylene glycol solutions containing Pt(IV) and Ru(III) ions to ionizing radiation from an electron beam and then depositing the nanoparticles onto carbon particles for support. The PtRu/C catalysts have performed very well in fuel cells [286, 287].

7.11. PTFE Crosslinking

PTFE can be crosslinked by electron beams at high temperatures (330-340°C) while in an inert gas and slightly above its melt transition temperature. Increased mechanical properties and wear resistance make the crosslinked PTFE suitable for sliding parts, rollers and bearings. Commercial quantities of this material are being produced in Japan [288].

7.12. Rubber Sheeting

Wide widths of calendared EB crosslinked sheeting are used for roofing and for pond and water retention basin linings and as material to prevent leakage from landfills. Sheeting is

commonly made from EB crosslinkable polyolefins, notably formulated ethylene-propylene diene rubber (EPDM) which responds well to EB processing [130].

7.13. Seed Disinfestation

Conventional treatments of seeds to control insects involve the use of toxic fumigants that can leave trace residues. Seeds can flow by gravity between two opposite low-energy (105 to 145 keV) EB units so that only the surface of the seed is exposed to ionizing irradiation. Tests have shown that some seeds that have been treated in an EB process yield an 11% increase in crop yield, more than double of what can be attained with chemical means of disinfestation [289, 290].

7.14. Soil Disinfestation

EB treatment of soils with doses of ~50 kGy eliminates pathogens and sterilizes the soil. Such soils can then be inoculated with a nitrogen fixing bacteria as *Bradyrhizobium* and *Rhizobium* to enhance crop yields of, for example, soy beans [291, 292].

7.15. Grafted Biologically Active Compounds

By incorporating enzymes into bio-compatible polyethylene glycols and then using EB to crosslink the polymer into a gel, one immobilizes the enzyme and enhances its lifetime and storage time.

7.16. Human Tissue Sterilization

Because it is a non-thermal process, radiation sterilization has been approved as a safety procedure in tissue banking. Soft tissues, such as skin, to be used for grafting onto patients, are not that adversely affected by exposure to sterilization doses, so that the mechanical properties remain intact [293, 294].

7.17. Direct Food Contact Coatings

The industrial association RadTech International North America's Food Packaging Alliance has obtained broad US FDA clearance for the use of a range of acrylate monomers that can be used in formulating direct food contact coatings. Such coatings can be used in lieu of film laminates and simplifies the printing and conversion of food packaging materials by enabling a printer to apply an over-print coating during the printing process. Low-energy EB can then cure the printing itself as well as the food contact coating [208, 295].

8. ELECTRON BEAM SERVICE CENTERS

In order to explore the merits of electron beam or X-ray processing, potential end-users can rely on a number of service facilities that charge for beam use by the hour or by the product load. Table XII lists the toll processing EB service facilities that are available in the Americas; Table XIII lists those in Europe, including Russia; and XIV lists those in the Asia-Pacific region and elsewhere. The EB facilities are presented in terms of beam energy and power. Different facilities have different under-beam handling equipment. Many have cart or conveyor systems that handle a range of materials for exploratory studies. Some have specific under-beam handling needed for wire, cable, and tubing (Figure 71) and accompanying pay-off and take-up equipment. Some facilities are dedicated to medical device sterilization or to food treatment. Those noted with an asterisk have X-ray conversion capabilities. These extensive lists are not exhaustive, but the results of an IAEA industry survey.

Table XII. Electron Beam Processing Service Facilities in the Americas

<u>Facility</u>	<u>Location</u>	<u>Beam energy</u>	<u>Beam power</u>
United States			
BeamOne	Denver, CO	10 MeV	15 kW
BeamOne	Lima, OH	10 MeV	18 kW
BeamOne	San Diego, CA	2 x 10 MeV	18 kW each
E-Beam Services	Cranbury, NJ	10 MeV	150 kW
E-Beam Services	Cranbury, NJ	5 MeV	75 kW
E-Beam Services	Lafayette, IN	1.5 MeV	75 kW
E-Beam Services	Lebanon, OH	5 MeV	150 kW
Electron Technologies	South Windsor, CT	1 MeV	20 kW
IBA Industrial	Edgewood, NY	3 MeV	90 kW*
NeoBeam	Middlebury, OH	5 MeV	150 kW
Sadex Corporation	Sioux City, IA	10 MeV	15 kW
Sterigenics	Bridgeport, NJ	10 MeV	190 kW*
Sterigenics	San Diego, CA	2 x12 MeV	7 kW each
Steris	Libertyville, IL	5 MeV	80 kW
Brazil			
IPEN	Sao Paulo	1.5 MeV	97.5 kW
Canada			
Acsion	Pinawa, Manitoba	10 MeV	1 kW
Iotron	Port Coquitlam, BC	10 MeV	60 kW

Costa Rica

Beam-One	Coyol Park	10 MeV	18 kW
----------	------------	--------	-------

Table XIII. Electron Beam Processing Service Facilities in Europe

<u>Facility</u>	<u>Location</u>	<u>Beam energy</u>	<u>Beam power</u>
Belgium			
Molnlycke	Waremmе	2 x 10 MeV	18 kW each
France			
Ionisos	Orsay	10 MeV	10 kW
Germany			
BGS	Bruchsal	4.5 MeV	150 kW
BGS	Brucshal	5.0 MeV	135 kW
BGS	Brucshal	10 MeV	200 kW*
BGS	Saal	10 MeV	150 kW
BGS	Wiehl	550 keV	11 kW
BGS	Wiehl	1.5 MeV	75 kW
BGS	Wiehl	2.7 MeV	80 kW
BGS	Wiehl	2.8 MeV	100 kW
Leoni Studer Hard	Bautzen	3 MeV	200 kW
Italy			
Bioster	Padua	10 MeV	15 kW
Bioster	Seriate	10 MeV	15 kW
Poland			
IHTJ	Warsaw	2.5 MeV	20 kW
Russia			
GHK	Krasnoyarsk	4.5 MeV	20 kW
Sintez	Kurgan	5-8 MeV	5 kW
NIIP	Lytarkino	10 MeV	10 kW
FMBCB	Moscow	10 MeV	10 kW
IPC	Moscow	5-8 MeV	5 kW
MRTI	Moscow	10 MeV	10 kW
Tori	Moscow	10 MeV	10 kW

BINP	Novosibirsk	1.5 MeV	100 kW
BINP	Novosibirsk	2.5 MeV	20 kW
BINP	Novosibirsk	5 MeV	50 kW
NIIFCI	Obninsk	10 MeV	10 kW
RAD	Saint Petersburg	10 MeV	15 kW
Spain			
Ionisos	Chaumesnil	10 MeV	20 kW
Switzerland			
Leoni Studer Hard	Däniken	1 MeV	65 kW
Leoni Studer Hard	Däniken	2 MeV	150 kW
Leoni Studer Hard	Däniken	3 x 2.5 MeV	100 kW each
Leoni Studer Hard	Däniken	3 MeV	220 kW
Leoni Studer Hard	Däniken	5-10 MeV	200 kW
Leoni Studer Hard	Däniken	X-ray only	700 kW*
Ukraine			
IPC	Kiev	2.5 MeV	20 kW
United Kingdom			
Isotron	Daventry	10 MeV	15 kW
Isotron	Harwell	10-12 MeV	10 kW
Isotron	South Marston	4.5 MeV	90 kW
Isotron	South Marston	1.5 MeV	60 kW

Table XIV. Electron Beam Processing Service Facilities in Asia-Pacific and Elsewhere

<u>Facility</u>	<u>Location</u>	<u>Beam energy</u>	<u>Beam power</u>
Egypt			
NCRRT	Cairo	1.5 MeV	25 kW
India			
BARC	Mumbai	2.5 MeV	20 kW
Korea			
Eb-Tech	Taejon	1.5 MeV	50 kW
Eb-Tech	Taejon	2.5 MeV	100 kW

Japan

JAERI	Takasaki	2.0 MeV	60 kW
JAERI	Takasaki	3.0 MeV	75 kW
JAERI	Takasaki	800 keV	24 kW
W-JISCO	Osaka	5.0 MeV	150 kW*
NFI	Osaka	10 MeV	200 kW*
Radia Industries	Takasaki	5.0 MeV	150 kW*
Tsukuba EB Center	Tsukuba City	5.0 MeV	200 kW*

Malaysia

Nuclear Malaysia	Kompleks Jalan	200 keV	4 kW
Nuclear Malaysia	Kompleks Jalan	1.0 MeV	50 kW
Nuclear Malaysia	Kompleks Jalan	3.0 MeV	90 kW

Syria

AECS	Damascus	3 MeV	100 kW
------	----------	-------	--------

* X-ray capability

Acronyms:

AECS: Atomic Energy Commission of Syria (Damascus, Syria)

BGS: Beta-gamma Services (Germany)

BINP: Budker Institute of Nuclear Physics (Russia)

FMBCB: Federal Medical Biological Center Burzanyan (Russia)

JAERI: Japan Atomic Energy Research Institute (Takasaki, Japan)

IPEN: Instituto de Pesquisas Energéticas e Nucleares (Sao Paulo, Brasil)

IPC: Institute of Physical Chemistry (Russia)

MINT: Malaysian Nuclear Agency (Bangi, Malaysia)

NCRRT: National Center for Radiation Research and Technology (Cairo, Egypt)

NFI: Nuclear Fuel Industries, Ltd. (Osaka, Japan)

W-JISCO: West- Japan Irradiation Service Co. Ltd. (Tsukuba-shi, Japan)

Pilot lines are available with low-energy EB units (Figure 30, 33, 36 and 37). In the low-energy area, there are also inexpensive (<200,000€), self-contained, self-shielded laboratory units (Figure 39). Laboratory work done on composites in France has shown that material studies conducted at low-energies can be translated into full product performance for products that are irradiated at higher energies, such as at 10 MeV [89].

REFERENCES

- [1] NATIONAL RESEARCH COUNCIL OF THE NATIONAL ACADEMIES. **Radiation Source Use and Replacement.** The National Academies Press, Washington, DC (2008).
- [2] MEISSNER, J., et al. X-ray treatment at 5 MeV and above. *Radiation Physics and Chemistry*, **57**, nos. 3-6 (2000) 647-651.
- [3] INTERNATIONAL ATOMIC ENERGY AGENCY. **Gamma Irradiators for Radiation Processing.** IAEA, Vienna, Austria (2005).
- [4] BEREJKA, A. J. Advances in self-shielded accelerators. **IAEA-TECDOC-1386**, *Emerging applications of radiation processing* (January 2004) 65-72.
- [5] TAGAWA, S., et al. Economic Scale of Utilization of Radiation (I): Industry. *Journal of Nuclear Science and Technology*, vol. 39, no. 9 (2002) 1002-1007.
- [6] LIN, Y. Applications of low energy accelerators in China. Proceedings of the Second Asian Particle Accelerator Conference, Beijing, China (2001) 851-857.
- [7] MACHI, S. Electron Accelerators for Industrial Applications in Japan. Presentation to IAEA Consultants Meeting, Vienna, July 21-25, 2008.
- [8] CHMIELEWSKI, A. G. and BEREJKA, A. J. Radiation sterilization centres worldwide. **Trends in radiation sterilization of health care products.** International Atomic Energy Agency, Vienna (2008) 49-62.
- [9] JONGEN, Y., et al. Advances in Sterilization with X-rays, Using a Very High Power Rhodotron and a Very Low DUR Pallet Irradiator. **IAEA-TECDOC-1386**, *Emerging applications of radiation processing* (January 2004) 44-54.
- [10] BEREJKA, A. J. Radiation response of industrial materials: Dose-rate and morphology implications. *Nuclear Instruments and Methods in Physics Research B* **261** (2007) 86-89.
- [11] CLELAND, M. R. *High Power Electron Accelerators for Industrial Radiation Processing. Radiation Processing of Polymers*, Hanser Publishers, Munich, and Oxford University Press, New York (1992) 23-49.
- [12] RECHEL, C. (editor). **UV/EB Curing Primer: Inks, Coatings and Adhesives.** RadTech International North America, Bethesda, Maryland (1991).
- [13] BEREJKA, A. J. Irradiation Processing in the 90's: Energy Savings and Environmental Benefits. *Radiation Physics and Chemistry*, **46**, Nos. 4-6, (1995) 429-437.
- [14] BEREJKA, A. J. Reengineering PSA Manufacture for VOC Reduction and Energy Savings. *Adhesives Age* (July 1997) 30-36.
- [15] BEREJKA, A. J. Radiation Chemistry: The Basis for an Inherently Green Process Technology. **Advancing Sustainability through Green Chemistry and**

-
- Engineering**, ACS Symposium Series 823, American Chemical Society, Washington, DC (2002) 163-176.
- [16] ASTM INTERNATIONAL. ISO/ASTM 51649 Standard Practice for Dosimetry in an Electron-Beam Facility for Radiation Processing at Energies Between 300 keV and 25 MeV, **Nuclear (II), Solar, and Geothermal Energy**, Vol. 12.02.
- [17] CLELAND, M. R., LISANTI, T.F. and GALLOWAY, R. A. Equations relating theoretical electron range values to incident electron energies for water and polystyrene. RDI-IBA Technical Information Series TIS 01556. IBA Industrial, Inc., Edgewood, NY (2003).
- [18] CLELAND, M. R. Radiation Processing: Basic Concepts and Practical Aspects. *Journal of Industrial Irradiation Technology*, **1**, no. 3 (1983) 191-218.
- [19] CLELAND, M. R. Industrial Applications of Electron Accelerators. CERN Accelerator School, Zeegse, The Netherlands (24 May to 2 June, 2005) at: <http://cas.web.cern.ch/cas/Holland/PDF-lectures/Cleland/School-2.pdf>.
- [20] CLELAND, M. R., GALLOWAY, R. A., HEISS, A. H. and LOGAR, J. R. Comparisons of Monte Carlo calculations with absorbed dose determinations in flat materials using high-current energetic electron beams. *Nuclear Instruments and Methods in Physics Research B* **261** (2007) 90-93.
- [21] CLELAND, M. R., GALLOWAY, R. A. and BEREJKA, A. J. Energy dependence of electron beam penetration, area throughput rates and electron energy utilization in the low- energy region. *Nuclear Instruments and Methods in Physics Research B* **261** (2007) 94-97.
- [22] BEREJKA, A. J. Electron Beam Cured Composites: Opportunities and Challenges. *The RadTech Report* (March/April 2002).
- [23] BLY, J. H. **Electron Beam Processing**. International Information Associates, Yardley, Pennsylvania (1988) 28.
- [24] CLELAND, M. R., GALLOWAY, R. A., GENIN, F. and LINDHOLM, M. The use of dose and charge distributions in electron beam processing. *Radiation Physics and Chemistry*, **63** (2002) 729-733.
- [25] ASTM INTERNATIONAL. ISO/ASTM 51818-02 Standard Practice for Dosimetry in an Electron Beam Facility for Radiation Processing at Energies Between 80 and 300 keV, **Nuclear (II), Solar, and Geothermal Energy**, Vol. 12.02.
- [26] CLELAND, M. R., GALLOWAY, R. A. and LISANTI, T. F. Low-energy electron beam dosimetry, RadTech 2008 Proceedings, RadTech International North America, Bethesda, Maryland (2008).
- [27] BLY, J. H. **Electron Beam Processing**. International Information Associates, Yardley, Pennsylvania (1988) 32-53.
- [28] BRADLEY, R. **Radiation Technology Handbook**. Marcel Dekker, Inc., New York (1984) 23.

-
- [29] SAMPA, M. H. O., RELA, P. R., and DUARTE, C. L. Industrial Wastewater Treatment in Brazil Using an Electron-Beam Accelerator. **Environmental Applications of Ionizing Radiation**, John Wiley & Sons, Inc., New York (1998) 521-530.
- [30] NATIONAL COUNCIL ON RADIATION PROTECTION AND MEASUREMENTS. **Radiation Protection for Particle Accelerator Facilities**, NCRP Report No. 144, Washington, DC (2003).
- [31] CLELAND, M. R. Application of high power X-ray generators for processing bulk materials. *Advances in radiation chemistry of polymers*, **IAEA-TEC-DOC-1420** (November 2002) 111-123.
- [32] FARRELL, J. P. High-power bremsstrahlung sources for radiation sterilization. *Radiation Physics and Chemistry*, **14**, nos. 3-6 (1979) 377-387.
- [33] FARRELL, J. P., SELTZER, S. M. and SILVERMAN, J. Bremsstrahlung Generators for Radiation Processing. *Radiation Physics and Chemistry*, Vol. **22**, Nos. 3-5 (1983) 469-478.
- [34] SELTZER, S. M., FARRELL, J. P. and SILVERMAN, J. Bremsstrahlung Beams from High-Power Electron Accelerators for Use in Radiation Processing. *IEEE Transactions on Nuclear Science*, Vol. NS-30, No. 2 (1983) 1629-1633.
- [35] GALLOWAY, R. A., LISANTI, T. F. and CLELAND, M. R. A New 5 MeV-300 kW Dynamitron for Radiation Processing. *Radiation Physics and Chemistry*, Vol. **71**, Issues 1-2 (2004) 551-553.
- [36] ABS, M., JONGEN, Y., PONCELET, E. and BOL, J.-L. A Very High Power E-Beam Accelerator. *Radiation Physics and Chemistry*, Vol. **71**, Issues 1-2 (2004) 287-290.
- [37] BEREJKA, A. J., CLELAND, M. R., GALLOWAY, R. and GREGOIRE, O. X-ray Curing of Composite Materials. *Nuclear Instruments and Methods in Physics Research B* **241** (2005) 847-849.
- [38] ASIMOV, I. **Atom – Journey across the subatomic cosmos**. Dutton, New York, New York (1991).
- [39] COOLIDGE, W. D. Vacuum-tube. US Patent 1,203,495 (October 31, 1916).
- [40] COOLIDGE, W. D. X-ray tube. US Patent 1,211,092 (January 2, 1917).
- [41] COOLIDGE, W. D. The production of high-voltage cathode rays outside of the generating tube. *Journal of The Franklin Institute*, **202** no. 6, (December, 1926) 693.
- [42] COOLIDGE, W. D. Electron discharge device. US Patent 1,907,507 (May 9, 1933).
- [43] COOLIDGE, W. D. and MOORE, C. N. Some experiments with high-voltage cathode rays outside of the generating tube. *Journal of The Franklin Institute*, **202** nos. 1207-1212 (July-December, 1926).
- [44] WESTENDORP, W. F. Voltage generating apparatus. US Patent 2,214,871 (September 17, 1940).

-
- [45] COCKCROFT, J. D. and WALTON, E. T. S. System for the transformation of direct current electrical energy. US Patent 1,992,908 (February 26, 1935).
- [46] WALOSCHEK, P. The Infancy of Particle Accelerators: Life and Work of Rolf Wideröe at: www.waloschek.de/pedro/pedro-texte/wid-e-2002.pdf.
- [47] HANSEN, W. W. High efficiency resonant circuit. US Patent 2,190,712 (February 20, 1940).
- [48] HANSEN, W. W. and VARIAN, R. H. Electrical convertor. US Patent 2,227,376 (December 31, 1940).
- [49] GINZTON, E. L., HANSEN, W. W. and KENNEDY, W. R. *Reviews of Scientific Instruments*, Vol. **19** (1948) 89.
- [50] VAN DE GRAAFF, R. J. Electrostatic generator. US Patent 1,991,236 (February 12, 1935).
- [51] TRUMP, J. Electrostatic apparatus. US Patent 2,252,668 (August 12, 1941).
- [52] VAN DE GRAAFF, R. J. High voltage electromagnetic apparatus having an insulating magnetic core. US Patent 3,187,208 (June 1, 1965).
- [53] EMANUELSON, R. Insulating core transformers. US Patent 3,274,526 (September 20, 1966).
- [54] LETOURNEL, M. Industrial electron accelerators. R. Hellborg (Editor) **Electrostatic Accelerators. Fundamentals and Applications**. Springer (2005) 581-593.
- [55] MARX, E. Verfahren zur Schlagprüfung von Isolatoren und anderen elektrischen Vorrichtungen, Deutsches Reichspatent No. DE455933 (February 13, 1928).
- [56] GRAGGS, J. D. and MEEK, J. M. Impulse Voltage Generation. **High Voltage Laboratory Technique**. Butterworths Scientific Publications, London (1954) 111-151.
- [57] BRASCH, A. and HUBER, W. Ultrashort Application Time of Penetrating Electrons: A Tool for Sterilization and Preservation of Food in the Raw State. *Science*, **105**, No. 2718 (1947) 112-117.
- [58] BRASCH, A. and HUBER, W. Reduction of Undersireable By-Effects in Products Treated by Radiation. *Science*, **108**, No. 2811 (1948) 536-537.
- [59] CLELAND, M. R. Voltage multiplication apparatus. US Patent 2,875,394 (February 24, 1959).
- [60] BUDKER, G. I., et al. Charged particle accelerator. US Patent 4,016,499 (April 5, 1977).
- [61] SALIMOV, R. A., et al. D.C. High Power Electron Accelerators of ELV-Series: Status Development. *Applications, Radiation Physics and Chemistry*, vol. **57**, nos. 3-6 (2000) 661-665.
- [62] AUSLENDER, V. L., et al. Radio-frequency electron accelerator. US Patent 4,140,942 (February 20, 1979).

-
- [63] AUSLENDER, V. L. ILU-type electron accelerator for industrial technologies. *Nuclear Instruments and Methods in Physical research, B* **89** (1984) 46-48.
- [64] AUSLENDER, V. L. and MESHKOV, N. Powerful Single-Cavity RF Accelerators and Their Use in the Industrial Radiation Chemical Processing Lines. *Radiation Physics and Chemistry*, vol. **35**, nos. 4-6 (1990) 627-631.
- [65] AUSLENDER, V. L., et al. Accelerators for E-Beam and X-Ray Processing. *Radiation Physics and Chemistry*, vol. **63**, nos. 3-6 (2002) 613-615.
- [66] AUSLENDER, V. L., et al. Bremsstrahlung converters for powerful industrial electron accelerators. *Radiation Physics and Chemistry*, **71** (2004) 297-299.
- [67] BRYAZGIN, A. A., et al. Electron Accelerator for Energy up to 5.0 MeV and Beam Power up to 50 kW with X-ray Converter. *Problems of atomic science and technology*, **1** (2004) 21-23.
- [68] IVANOV, A. S., MAZNEV, V. P., OVCHINNIKOV, V. P., SVININ, M. P., and TOLSTUN, N. G. Present State of Works on Development of Electron Accelerators for Energy Consuming Processes at Efremov Research Institute. Prospects and Challenges in Application of Radiation for Treating Exhaust Gases, Warsaw (May 2007).
- [69] ABRAMYAN, E. A. **Industrial Electron Accelerators and Applications**. Hemisphere Publishing Corporation, New York, New York (1988).
- [70] SCHARF, W. H. **Particle Accelerators – Applications in Technology and Research**. Research Studies Press Ltd., Taunton, England (1989).
- [71] KOLESKE, J. V. **Radiation Curing of Coatings**. ASTM International, West Conshohocken, Pennsylvania (2002).
- [72] BURLANT, W. J. Process of coating the exterior surface of articles with a polymerizable coating material subjected to high energy ionizing radiation. US Patent 3,247,012 (April 19, 1966).
- [73] FARRELL, S. R., DEMETER, L. J. and WOODS, P. G. Broad beam electron gun. US Patent 3,863,163. (January 28, 1975).
- [74] QUINTAL, B. S. Apparatus for and method of producing an energetic electron curtain. US Patent 3,702,412 (November 7, 1972).
- [75] NABLO, S. V. Electron-Beam Processing Machinery. **Radiation Curing in Polymer Science and Technology – Volume 1: Fundamentals and Methods** (Fouassier and Rabek, eds.), Elsevier Applied Science, London (1993) 504-551.
- [76] RANGWALLA, I., CLOUGH, H. and HANNAFIN, G. Particle beam processing apparatus. US Patent 6,426,507 (July 30, 2002).
- [77] HOLL, P., DIECK, E. L. and REUTER, G. Low-energy electron scanners and their applications in industry. **Radcure '84 Conference Proceedings**. Association for Finishing Processes of the Society of Manufacturing Engineers, Dearborn, Michigan (September 1984) 12-12 to 12-31.

-
- [78] HOLL, P. Multistage charged particle accelerator, with high-vacuum insulation. US Patent 3,949,265 (April 6, 1976).
- [79] AVNER, T. Electron beam accelerator. US Patent 5,962,995 (October 5, 1999).
- [80] BEREJKA, A. J., AVNER, T. and CARLSON, C. Modular low-voltage electron beams. *Radiation Physics and Chemistry*, Vol. 71 (2004) 301-305.
- [81] N'GUYEN, A. and POTTIER, J. Electron accelerator with coaxial cavity. US Patent 5,107,221 (April 21, 1992).
- [82] JONGEN, Y., et al. The RHODOTRON: A new electron accelerator for industrial use. **Proceedings RadTech '92**, RadTech International North America, Bethesda, Maryland, vol. 2 (1992) 863-866.
- [83] SMITH, R. R. and FARRELL, S. R. 2 MeV linear accelerator for industrial applications. The fourteenth international conference on the application of accelerators in research and industry, AIP Conference Proceedings vol. **392**, (February 5, 1997) 1093-1098.
- [84] SADAT, T. Use of electron beams for decontamination of mechanically separated poultry meat. *Radiation Physics and Chemistry*, vol. **22**, nos. 3-5 (1983) 759-563.
- [85] SADAT, T. Electron beams processing in food industry technology and costs. *Radiation Physics and Chemistry*, vol. **25**, nos. 1-3 (1985) 81-96.
- [86] UEHARA, S., TANIGUCHI, S., KASHIWAGI, M., MIZUSAWA, K. and SAKAMOTO, I. A 5 MV 30 mA EB/X-Ray Processing System, *Radiation Physics and Chemistry*, vol. **42**, nos. 1-3 (1993) 515-518.
- [87] MIZUSAWA K., KASHIWAGI M. and HOSHI Y. 5 MeV electron beam facilities in Japan. *Radiation Physics and Chemistry*, vol. **52**, nos. 1-6 (1998) 475-477.
- [88] GIELENZ, G. E-beam Crossfire Processing. Accelerator Symposium, Sao Paulo, Brazil (November, 2001).
- [89] COQUERET, X., DEFOORT, B., DUPILIER, J. M. and LARNAC, G. Polymerization kinetics of acrylate monomers under UV/EB radiation: from lab scale monitoring to the modeling of industrial curing. Radtech Europe Conference Papers Archive 2003 at: www.radtech-europe.com – Events: Conference 2003: Paper Archive 2003.
- [90] BEREJKA, A. J., MONTONEY, D., CLELAND, M. R., and LOISEAU, L. Radiation Curing: Coatings and Composites. PolyRay 2009, Reims, France (March, 2009).
- [91] BEREJKA, A. J. Prospects and Challenges for the Industrial Use of Electron Beam Accelerators. International Topical Meeting on Nuclear Research Applications and Utilization of Accelerators (AccApp '09), Vienna, Austria (May 4-8, 2009).
- [92] RECHEL, C. (editor). **UV/EB Curing Primer: Inks, Coatings and Adhesives**. RadTech International North America, Bethesda, Maryland (1991) 8-10, 22-38.

-
- [93] CHARLESBY, A. **Atomic Radiation and Polymers**. Pergamon Press, London (1960).
- [94] CHAPIRO, A. **Radiation Chemistry of Polymeric Systems**. Interscience Publishers, John Wiley & Sons, New York, New York (1962).
- [95] DOLE, M. **The Radiation Chemistry of Macromolecules**. Academic Press (January 1972).
- [96] SILVERMAN, J. A. and SINGH, A. (editors). **Radiation Processing of Polymers**, Hanser Publishers, Munich, and Oxford University Press, New York (1992).
- [97] TABATA, Y., TAGAWA, S. and ITO, Y. **CRC Handbook of Radiation Chemistry**. CRC Press LLC Publishing (January, 1991).
- [98] SPINKS, J. W. T. and WOODS, R. J. **An Introduction to Radiation Chemistry**. Wiley, New York, NY (1964).
- [99] WOODS, R. J. and PIKAEV, A. K. **Applied Radiation Chemistry**, John Wiley & Sons, New York, (1994).
- [100] BRADLEY, R. **Radiation Technology Handbook**. Marcel Dekker, Inc., New York (1984).
- [101] DROBNY, J. GEORGE. **Radiation Technology for Polymers**. CRC Press, Boca Raton, Florida (2003).
- [102] GROSMIRE, P. R. Electron-Beam Curing of Paints and Varnishes on Wood Panels. *Radiation Physics and Chemistry*, vol. 9, nos. 4-6 (1977) 857.
- [103] CHMIELEWSKI, A. G., HAJI-SAEID, M. and AHMED, S. Progress in radiation processing of polymers. *Nuclear Instruments and Methods in Physics Research B* in publication (2005).
- [104] HALL, E. J. **Radiobiology for the Radiologist**. J.B. Lippincott Company, Philadelphia, Pennsylvania (2000) fifth edition.
- [105] von SONNTAG, C. **Free-radical-induced DNA Damage and Its Repair: A Chemical Perspective**, Springer-Verlag, Berlin, Germany (2006).
- [106] CRIVELLO, J. V. Diaryliodonium salts. US Patent 4,310,469 (January 12, 1982).
- [107] ASTM INTERNATIONAL. **Plastics**. Vol. 08.01.
- [108] ASTM INTERNATIONAL. **Plastics**. Vol. 08.02.
- [109] ASTM INTERNATIONAL. **Rubber**. Vol. 09.01.
- [110] BRADLEY, R. The electron beam: a tool for the eighties. *CHEMTECH*, the American Chemical Society, Washington, DC, vol. 11 (1981) 234-237.
- [111] DAWES, K. and GLOVER, L. C. Effects of Electron Beam and γ -Irradiation on Polymeric Materials. **Physical Properties of Polymers Handbook**, American Institute of Physics, Woodbury, New York (1996) 557-576.

-
- [112] ASTM INTERNATIONAL. **ASTM Standards Related to Testing of Radiation Cured Coatings**. West Conshohocken, Pennsylvania (2002).
- [113] DOLE, M. Report on Symposium IX “Chemistry and Physics of Radiation Dosimetry”. Army Chemical Center, Maryland (1950) 120.
- [114] CHARLESBY, A. *Proceedings of the Royal Society*. A215, 187 (1952).
- [115] BURNS, N. M. The Radiation Crosslinking of Ethylene Copolymers. *Radiation Physics and Chemistry*, vol. **14**, nos. 3-6, (1979) 797-808.
- [116] ASTM INTERNATIONAL. **General Products, Chemical Specialties, and End Use Products**. Vol. 15.09.
- [117] DUNN, T. S., et al. Radical Structure and its Role in the Oxidative Degradation of γ -Irradiated Polypropylene. *Radiation Physics and Chemistry*, vol. **14**, nos. 3-6, (1979) 625-634.
- [118] WILLIAMS, J., DUNN, T. and STANNETT, VIVIAN. Irradiation sterilization of semi-crystalline polymers. US Patent 4,110,185 (August 29, 1978).
- [119] PORTNOY, R. C. Clear, Radiation Sterilizable, Autoclavable Blends Based on Metallocene Catalyzed Propylene Homopolymer. Society of Plastics Engineers, ANTEC Proceedings, 75, vol. 3 (1999) 3011-3015.
- [120] SAWASAKI, T. and NOJIRI, A. Radiation crosslinking of polypropylene. *Radiation Physics and Chemistry*, vol. 31, nos. 4-6, (1988) 877-886.
- [121] PORTNOY, R. C., BEREJKA, A. J., CLELAND, M. R. and GALLOWAY, R. A. A comparison of the effects on polypropylene using sterilizing doses from three different sources of ionizing radiation. Society of Plastics Engineers, ANTEC Proceedings (2007).
- [122] BEREJKA, A. J. and KALUSKA, I. Materials used in medical devices. **Trends in radiation sterilization of health care products**. International Atomic Energy Agency, Vienna (2008) 159-174.
- [123] CHAPIRO, A. **Radiation Chemistry of Polymeric Systems**. Interscience Publishers, John Wiley & Sons, New York, New York (1962) 355, 507.
- [124] TIMMERMAN, R. Cross-linking of Polyvinylidene Fluoride and Wire Coated with the Cross-linked Resin. US Patent 3,142,629 (July 28, 1964).
- [125] BOWERS, G. H. and LOVEJOY, E. R. Cross linking of Teflon 100 FEP-fluorocarbon resin by radiation. *I&EC Product Research and Development*, the American Chemical Society, Washington, DC, Vol. **1**, no. 2 (June 1962) 89-92.
- [126] OSHIMA, A., IKEDA, S., SEGUCHI, T. and TABATA, Y. Improvement of radiation resistance for polytetrafluoroethylene (PTFE) by radiation crosslinking. *Radiation Physics and Chemistry*, vol. **49** (1997) 279-284.
- [127] SEGUCHI, T. New trend of radiation application to polymer modification: Irradiation in oxygen free atmosphere and at elevated temperature. *Radiation Physics and Chemistry*, vol. **57** (2000) 367-371.

-
- [128] ASTM INTERNATIONAL. **General Test Methods; Forensic Psychophysiology; Forensic Sciences; Terminology; Conformity Assessment; Statistical Methods; Nanotechnology General Products, Chemical Specialties, and End Use Products.** Vol. 14.02.
- [129] NEWTON, E. B. Method of vulcanizing rubber. US Patent 1,906, 402 (May 2, 1933).
- [130] SPENADEL, L. Radiation crosslinking of polymer blends. *Radiation Physics and Chemistry*, vol. **14**, nos. 3-6 (1979) 683-697.
- [131] ZAPP, R. L. and OSWALD, A. A. Polythiol accelerated radiation crosslinking of olefinically unsaturated allylically halogenated polymers. US Patent 4,094,757 (June 13, 1978).
- [132] BALDWIN, F. P. Process for preparing conjugated diene butyl. US Patent 3,775,387 (November 27, 1973).
- [133] BEREJKA, A. J. and BRADLEY, R. Polybutylene and conjugated diene butyl polymer blends. US Patent 4,300,988 (November 17, 1981).
- [134] ERICKSON, J. R. EB curable rubber has more heat and solvent resistance. *Adhesives Age* (April, 1986).
- [135] SPENADEL, L., GROSSER, J. H. and DWYER, S. M. Elastomer-plastic blends. US Patent 4,843,129 (June 27, 1989).
- [136] CHAPIRO, A. **Radiation Chemistry of Polymeric Systems.** Interscience Publishers. John Wiley & Sons, New York (1962) 596-691.
- [137] CARENZA, M. The use of Radiation Polymerization and Grafting for Biomedical Applications. *International Journal of Radiation Applications and Instrumentation. Part C. Radiation Physics and Chemistry*, **39**, Issue 6 (June 1992), 485-493.
- [138] BEREJKA, A. J. Electron Beam grafting of polymers. Advances in radiation chemistry of polymers **IAEA-TECDOC-1420** (November 2004) 85-89.
- [139] KING, P. A. Ionizing radiation of water solution of polyalkylene oxide and product thereof. US Patent 3,264,202 (August 2, 1966).
- [140] ASSARSSON, P. G. and KING, P. A. Process for cocrosslinking water soluble polymers and products thereof. US Patent 3,993,551 (November 23, 1976).
- [141] ROSIAK, J. M., et al. Radiation formation of hydrogels for biomedical applications. **IAEA-TEC DOC 1324** (2002).
- [142] ERSHOV, B. G. Radiation-chemical degradation of cellulose and other polysaccharides. *Russian Chemical Reviews*, **67** (1998), 315-334.
- [143] ERSHOV, B. G. and KLIMENTOV, A. S. The radiation chemistry of cellulose. *Russian Chemical Reviews*, **53** no. 12 (1984), 1195-1207.
- [144] FREE, D. Process for subjecting wood chips to irradiation with electrons. US Patent 3,801,432 (April 2, 1974).

-
- [145] KHAN, A. W., LABRIE, J-P. and McKEOWN, J. Effect of electron-beam irradiation pretreatment on the enzymatic hydrolysis of softwood. *Biotechnology and Bioengineering*, **28**, no. 9 (2004) 1449-1453.
- [146] SCHRÖDINGER, E. **What is Life?** Cambridge University Press, Cambridge, England (1944).
- [147] WATSON, J. D. and CRICK, F. H. C. Molecular Structure of Nucleic Acids: A structure for deoxyribose nucleic acid. *Nature* (April 25, 1953) 737-738.
- [148] WATSON, J. D. and CRICK, F. H. C. Genetical Implications of the Structure of Deoxyribonucleic Acid. *Nature* (May 30, 1953) 964-967.
- [149] WALTAR, A. E. **Radiation and Modern Life**. Prometheus Books, Amherst, New York (2004) 46-50.
- [150] LUCKEY, T.D. **Radiation Hormesis**. CRC Press, Boca Raton, Florida (1991).
- [151] American National Standard ANSI/AAMI/ISO 11137-1, -2 and -3 **Sterilization of Health Care Products – Radiation**. Association for the Advancement of Medical Instrumentation, Arlington, Virginia (2006).
- [152] HALL, E. J. **Radiobiology for the Radiologist**. J.B. Lippincott Company, Philadelphia, Pennsylvania (2000) fifth edition, 46.
- [153] WATSON, J. D. **DNA – The Secret of Life**. Alfred A. Knopf, New York, NY (2003).
- [154] TALLENTIRE, A., PURDIE, J. W. and EBERT, M. Increased response of anoxic *Bacillus megaterium* spores to radiation at high dose-rates. *International Journal of Radiation Biology*, vol. **26**, no. 5 (1974) 435-443.
- [155] TALLENTIRE, A. and BARBER, D. J. W. The Interrelationship between Pulse Length and Dose-rate within the Pulse in the Enhancement of Atomic Damage in Wet *Bacillus megaterium* Spores Irradiated with Pulses of Electrons. Sixth Symposium on Microdosimetry (Booz and Ebert, ed.) Harwood Academic Publishers Ltd. (1978) 1061-1069.
- [156] BARBER, D. J. W. and TALLENTIRE, A. Modification by Chemical and Physical Means of the Pulse Dose Effect in Irradiated Bacterial Spores. Seventh Symposium on Microdosimetry (Booz, Ebert and Hartfield, ed.) Harwood Academic Publishers Ltd. (1980) 1145-1155.
- [157] TALLENTIRE, A. Oxygen effect, hydrogen peroxide yields, and time scale of interaction of potentially damaging species in electron pulse irradiated bacterial spores. *Advances in Space Research*, vol. **3**, no. 8 (1983) 105-112.
- [158] DeVEAUX, L. C., et al. Effect of Electron Beam Dose Rate on Microbial Survival. Proceedings AccApp '07, Pocatello, ID (July 29-August 2, 2007) 388-393.

-
- [159] NATIONAL RESEARCH COUNCIL OF THE NATIONAL ACADEMIES. **Radiation Source Use and Replacement.** The National Academies Press, Washington, DC (2008) 116.
- [160] COLE, L. A. **The Anthrax Letters.** John Henry Press, Washington, DC (2003).
- [161] ATTIX, F. H. and ROESCH, W. C. (editors). **Radiation Dosimetry** (second edition, Volume 1), Academic Press, New York, NY (1968) 6-18.
- [162] HUMPHREYS, J. C. and McLAUGHLIN, W. L. Calibration of electron beams and the calibration of dosimeters at high doses. *Radiation Physics and Chemistry*, vol. **35**, nos. 4-6, (1990) 744-749.
- [163] HELT-HENSEN, J., et al. Calibration of thin-film dosimeters irradiated with 80-120 keV electrons. *Radiation Physics and Chemistry*, vol. **71**, nos. 1-2, (2004) 355-359.
- [164] BEREJKA, A. J. Characterization of a low-voltage electron beam. *Radiation Physics and Chemistry*, vol. **71**, nos. 1-2, (2004) 307-310.
- [165] CLELAND, M. R., GALLOWAY, R. A., HEISS, A. H. and LOGAR, J. R. Comparisons of Monte Carlo calculations with absorbed dose determinations in flat materials using high-current, energetic electron beams. *Nuclear Instruments and Methods in Physics Research B* **261** (2007) 90–93.
- [166] CLELAND, M. R., GALLOWAY, R.A. and BEREJKA, A. J. Energy dependence of electron beam penetration, area throughput rates and electron energy utilization in the low-energy region. *Nuclear Instruments and Methods in Physics Research B* **261** (2007) 94–97.
- [167] CLELAND, M. R. and GALLOWAY, R. A. Dosimetry for low-energy electron beams. Proceedings of AccApp'07, Pocatello, Idaho (2007).
- [168] POPOV, G. F., LAZURIK, V. T., LAZURIK, V. M. and ROGOV, Y. V. RT-Office for electron beam, X-ray, and gamma-ray dosimetry. Proceedings of EPAC 2004, Lucerne, Switzerland (2004) 2403-2405.
- [169] KOVACS, A. and MILLER, A. Present Status and Expected Progress in Radiation Processing Dosimetry. **IAEA-TECDOC-1386**, *Emerging applications of radiation processing* (January 2004) 85-93.
- [170] REGULLA, D. F. and DEFFNER, U. Dosimetry by ESR spectroscopy of alanine, *International Journal of Applied Radiation and Isotopes*, **33**, no. 11 (1982) 1101-1114.
- [171] DESROSIERS, M. F., et al. Next-generation services for e-traceability to ionizing radiation national standards. *Radiation Physics and Chemistry*, **71**, nos. 1-2, (2004) 371-374.
- [172] HEISS, A. and BEREJKA, A. J. E-beam Low Voltage Alanine EPR Dosimetry, e|5: **UV & EB Technology Expo & Conference 2006**, RadTech International North America (May 2006).

-
- [173] CHARLESBY, A. **Atomic Radiation and Polymers**. Pergamon Press, London (1960) 108.
- [174] CHARLESBY, A. and DAVISON, W. H. T. *Chemistry and Industry*, (1957) 232-233.
- [175] JOHNSON, W. C. and LYONS, B. J. Radiolytic formation and decay of trans-vinylene unsaturation in polyethylene: fourier transform infra-red measurements, *Radiation Physics and Chemistry*, **46**, nos. 4-6 (1995) 829-832.
- [176] LYONS, B. J. Radiolytic unsaturation decay in polyethylene. Part I – general review and analysis with additional new work, *Radiation Physics and Chemistry*, **69**, (2004) 495-502.
- [177] LYONS, B. J. Radiolytic unsaturation decay in polyethylene. Part II – the effect of irradiation temperature, thermal history and orientation, *Radiation Physics and Chemistry*, **69**, (2004) 503-510.
- [178] LYONS, B. J. Radiolytic unsaturation decay in polyethylene. Part III – the effect of certain chain transfer agents, *Radiation Physics and Chemistry*, **70**, (2004) 707-717.
- [179] ASTM INTERNATIONAL. ASTM D-6248 Standard Test Method for Vinyl and Trans Unsaturation in Polyethylene by Infrared Spectroscopy, **Plastics**. Vol. 08.03.
- [180] ASTM INTERNATIONAL. ASTM F-2381 Standard Test Method for Evaluating Trans-Vinylene Yield in Irradiated Ultra-High-Molecular-Weight Polyethylene Fabricated Forms Intended for Surgical Implants by Infrared Spectroscopy, **Medical and Surgical Materials and Devices; Anesthetic and Respiratory Equipment; Manufacture of Pharmaceutical Products**, Vol. 12.01.
- [181] PATACZ, C., DEFOORT, B. and COQUERET, X. Electron-beam initiated polymerization of acrylate compositions 1: FTIR monitoring of incremental irradiation, *Radiation Physics and Chemistry*, **59** (2000) 329-337.
- [182] TESTONI, A., NORASETTHEKUL, S., and FLECTCHER, P. M. Challenges of Using Radiachromic Films as Dosimeters for Low Voltage Electron Beams. Proceedings RadTech International North America conference (May 2008).
- [183] DRISCOLL, M., MONTONEY, D., and BEREJKA, A. J. Routine Low-energy Dosimetry with Thin Gauge Polyethylene Films. Proceedings RadTech International North America conference (May 2008).
- [184] BEREJKA, A. J., DRISCOLL, M. and MONTONEY, D. Polyethylene: a Dosimeter for use with Ionizing Radiation. Society of Plastics Engineers International Polyolefins Conference, Houston (February 2009).
- [185] BLY, J. H. **Electron Beam Processing**. International Information Associates, Yardley, Pennsylvania (1988) 55-73.
- [186] ESSO CHEMICALS. **Vistalon Ethylene-Propylene Elastomers Radiation Cured Electrical Materials** (1982).
- [187] COOK, P. M. and MUCHMORE, R. W. Process and Apparatus for Producing Materials having Plastic Memory. US Patent 3,086,242 (April 23, 1963).

-
- [188] BAIRD, W. G., JR, et al. Method of Producing Film having Improved Shrink Energy. US Patent 3,022,543 (February 27, 1962).
- [189] BAIRD, W. G., JR. Applications in Plastic Sheet and Film. *Radiation Physics and Chemistry*, vol. 9, nos. 1-3, (1977) 225-233.
- [190] WEIGERT, H. J. Cross Linking and Dosimetry at CRYOVAC, at the Council on Ionizing Radiation Measurements and Standards meeting (October 2005).
- [191] TRAGESER, D. A. Crosslinked Polyethylene Foam Processes. *Radiation Physics and Chemistry*, vol. 9, nos. 1-3, (1977) 261-270.
- [192] HUNT, J. D. and ALLIGER, G. Rubber – Application of radiation to tire manufacture. *Radiation Physics and Chemistry*, vol. 14, nos. 1-2 (1979) 39-53.
- [193] BARTOS, D. M. and PRICE, R. J. Flexible resistance element with flexible and stretchable terminal electrodes. US Patent 3,344,385 (September 26, 1967).
- [194] KOHLER, F. and RUDD, W. C. Plastic resistance elements and methods for making same. US Patent 3,351,882 (November 7, 1967).
- [195] KOHLER, F. Resistance element. US Patent 3,243,753 (March 19, 1966).
- [196] SMITH-JOHANNSEN, R. Method of making self limiting heat elements. US Patent 3,793,716 (February 26, 1974).
- [197] KAMPE, A. J. PTC heaters. US Patent 4,334,148 (June 8, 1982).
- [198] LYONS, B. J. and YOUNG, J. K. Voltage stable positive temperature coefficient of resistance crosslinked compositions. US Patent 4,118,276 (February 12, 1980).
- [199] WHITNEY, W. and HORSMA, D. A. Temperature overshoot heater. US Patent 4,017,715 (April 12, 1977).
- [200] HORSMA, D. A. and DIAZ, S. H. Heat-recoverable sealing article with self-contained heating means and method of sealing a splice therein. US Patent 4,085,286 (April 18, 1978).
- [201] MIDDLEMAN, L. M., EVANS, J. H. and PETTENGILL, D. F. Circuit protection devices comprising PTC elements. US Patent 4,238,812 (December 9, 1980).
- [202] DOLJACK, F. PolySwitch PTC – A New Low-Resistance Conductive Polymer-Based PTC Device for Overcurrent Protection. *IEEE Transactions on Component, Hybrids, and Manufacturing Technology*, 4, number 4 (December 1981) 372- 378.
- [203] READDY, A. F. **Applications of Ionizing Radiation in Plastics and Polymer Technology**. Plastics Technical Evaluation Center, Picatinny Arsenal, Dover, New Jersey (March 1971) 102-118.

-
- [204] FELIS, K. P., AVNER, T. and BEREJKA, A. J. Innovative energy efficient low-voltage electron beam emitters. *Radiation Physics and Chemistry*, **63** (2000) 605-608.
- [205] BEREJKA, A. J. Electron Beam Curing of Coil Coatings. *The RadTech Report*, (September/October 2003) 47-53.
- [206] AVNER, T. Electron beam irradiation apparatus. US Patent 6,833,551 (December 21, 2004).
- [207] CARLICK, D. J. Status of E. B. Curable Inks and Coatings in the U.S. *Proceedings RadTech Asia '91*, RadTech Japan, Tokyo, Japan (1991) 140-150.
- [208] CHATTERJEE, S., LAKSIN, M., BIRO, D. and TURGIS, J. D. Radiation curable aqueous compositions for low extractable film packaging. US Patent 6,803,112 (October 12, 2004).
- [209] BEREJKA, A. J. Energy Efficiency: Radiant Energy Processing: An Energy-Efficient, Pollution Preventing Industrial Technology. *Environmental Quality Management*, (Autumn 2002) 101-106.
- [210] RICHTER, K. B. Pulsed electron beam curing of polymer coatings. 13th International Coating Science and Technology Symposium (September 13, 2006).
- [211] WEISS, D., DUNN, D., RICHTER, K. B. and ADLER, R. Pulsed electron beam polymerization. Pressure Sensitive Tape Council (May 15, 2005).
- [212] BEREJKA, A. J. Radiation response of industrial materials: Dose-rate and morphology implications. *Nuclear Instruments and Methods in Physics Research B* **261** (2007) 86-89.
- [213] MACHADO, L. D. B., et al. TA of PVAL hydrogel cross-linked by chemical and EB irradiation process used as artificial cartilage. *Journal of Thermal Analysis and Calorimetry*, **75** (2004) 445-451.
- [214] BECK, J.A. and MORRISSEY, R. F. An Overview of Radiation Sterilization Technology. **Sterilization of Medical Products**, Vol. IV, Johnson & Johnson Conference, Polyscience Publications, Inc., Montreal, Canada (1986) 115-131.
- [215] ATANDI, C. and VAN WINKLE, W. Jr., Electron-Beam Sterilization of Surgical Sutures. *Nucleonics*, Vol. 17 (3) (1959) 86-90.
- [216] KOTLER, J. and BORSA, J. Product Irradiator for Optimizing Dose Uniformity in Products. US Patent 6,504,898 (January 7, 2003).
- [217] STICHELBAUT, F., et al. The PalletronTM: A High-Dose Uniformity Pallet Irradiator with X-Rays. *Radiation Physics and Chemistry*, Vol. 71 (2004) 291-295.
- [218] COUNCIL ON IONIZING RADIATION MEASUREMENTS AND STANDARDS. **Fourth Report on Needs in Ionizing Radiation Measurements and Standards** (December 2004) 78-85.
- [219] KALUSKA, I. and ZIMEK, Z. The impact of European Standards concerning radiation sterilization on the quality assurance of medical products in Poland. IAEA-SM-356/33.

-
- [220] MEDICAL DEVICELINK.COM. At:
<http://dev.devicelink.com/emdm/archive/98/10/ind.html>.
- [221] CHMIELEWSKI, A. G., SADAT, T. and ZIMEK, Z. Electron accelerators for radiation sterilization. **Trends in radiation sterilization of health care products**. International Atomic Energy Agency, Vienna (2008) 40-41.
- [222] FONTCUBERTA, P., MALCOLM, F. and MORISSEAU, D. Further developments in low, medium and high energy accelerator facilities for sterilisation, material modification and research including complex turnkey installations. 15th International Meeting on Radiation Processing, London (September 2008).
- [223] FONTCUBERTA P. In-line e-beam sterilization tunnel. PDA Pre-Filled Syringes Interest Group Meeting, Berlin (December 2008).
- [224] MINCK, F. On the question of the action of Roentgen's rays on bacteria and a possible therapeutic utilization. *Muenchener Medicinische Wochenschrift* 43 (5), (1896) 101-102.
- [225] LIEBER, H. Preserved radio-active organic matter and food. US Patent 788,480 (April 25, 1905).
- [226] APPLEBY, J. and BANKS, A. J. Improvements in or relating to the treatment of foodstuffs, more especially cereals and their products. British patent GB 1609 (January 4, 1906).
- [227] SCHWARTZ, B. Effect of X-rays on Trichinae. *Journal of Agricultural Research* 20 (1921) 845.
- [228] DIEHL, J. F. Food irradiation—past, present and future. *Radiation Physics and Chemistry*, 62, nos. 3-6, (2002) 211-215.
- [229] US Department of Health and Human Services, Food and Drug Administration. Code of Federal Regulations (CFR) 2004. Irradiation in the Production, Processing and Handling of Food, Final Rule. 21 CFR Part 179, Docket No. 2003F-0088, Fed Reg 69(246): 76844-76847.
- [230] WORLD HEALTH ORGANIZATION (WHO). Report of a Joint FOA/IAEA/Who Expert Committee: Wholesomeness of irradiated food. *WHO Technical Report Series* 659, Geneva, Switzerland (1981).
- [231] WORLD HEALTH ORGANIZATION (WHO). Food Irradiation. *In Point of Fact*. 40 Geneva, Switzerland (1987).
- [232] CLELAND, M. R. Advances in Gamma Ray, Electron Beam, and X-ray Technologies for Food Irradiation. **Food Irradiation Research and Technology** (Sommers, C. H. and Fan, X. editors). Wiley-Blackwell (2006) 11-35.
- [233] COUNCIL ON IONIZING RADIATION MEASUREMENTS AND STANDARDS. **Fourth Report on Needs in Ionizing Radiation Measurements and Standards** (December 2004) 86-92.

-
- [234] NABLO, S. V. Process and apparatus for surface sterilization of materials. US Patent 3,780,308 (December 18, 1973).
- [235] NASLUND, L. A., et al. Device and method for electron beam irradiation. US Patent application 2006/028411 (December 21, 2006).
- [236] SADAT, T. and HUBER, T. E-Beam – a new transfer system for isolator technology. *Radiation Physics and Chemistry*, **63**, (2002) 587-589.
- [237] MORISSEAU, D. and MALCOLM, F. SterStar system: continuous sterile transfer by e-beam. *Radiation Physics and Chemistry*, **71**, (2004) 555-558.
- [238] SADAT, T. and MALCOLM, F. A new e-beam application in the pharmaceutical industry. *Nuclear Instruments and Methods in Physics Research B*, **240** (2005) 100-104.
- [239] FURNESS, G. Current considerations and future directions for E-beam sterilisation in the pre-filled syringe market: an overview. Prefilled Syringes: the Container of Choice for Today's Injectables, *ONdrugDelivery*, (2008) 18-20.
- [240] FISHER, W. K. Effect of Ionizing Radiation on the Chemical Composition, Crystallinity, and Processibility of Polytetrafluoroethylene, *Journal of Industrial Irradiation Technology*, vol. **1**, no. 2 (1983) 105-139.
- [241] DERBYSHIRE, R. L. Treatment of Sintered Poly-tetrafluoroethylene with irradiation and Heat to Produce a Grindable Material, US Patent 4,220,511 (September 2, 1980).
- [242] NEUBERG, W. B. and LUNIEWSKI, R. Apparatus and method for radiation processing of materials. US Patent 4,748,005 (May 31, 1988).
- [243] ZYBALL, A. Radiation processing of polymers. **IAEA-TECDOC-1386**, *Emerging applications of radiation processing* (January 2004) 117-125.
- [244] ZYBALL, ALFRED. Production and crosslinking of multi-layer tubes (PE & metal) by E-beam, *Radiation Physics and Chemistry*, **57**, (2000) 543-547.
- [245] MACHI, S., et al. Radiation process for the production of graft copolymer to be used for ion-exchange membrane. US Patent 4,137,137 (January 30, 1979).
- [246] D'AGOSTINO, V. F., LEE, J. Y. and SENTISI, J. C. Separator membranes for electrochemical cells. US Patent 4,230,549 (October 28, 1980).
- [247] MACHI, S., et al. Ion exchange membrane by radiation crosslinking. Second International Meeting on Radiation Processing, Miami, FL, (22-26 October 1978).
- [248] DEGEN, P. J. and LEE, J. Positively charged polyvinylidene fluoride membrane. US Patent 5,282,971 (February 1, 1994).
- [249] KRISHNAN, S., et al. 8 MeV electron irradiation effects in silicon photo-detectors. *Nuclear Instruments and Methods in Physics Research B* **264** (2007) 79-82.
- [250] KRISHNAN, S., et al. Electron irradiation effects on the Schottky diode characteristics of p-Si. *Nuclear Instruments and Methods in Physics Research B* **266** (2008) 621-624.

-
- [251] ASHBROUGH, C. E. III. Gemstone Irradiation and Radioactivity. *Gems and Gemology* (Winter 1988) 196-213.
- [252] CALVO, W. A. P. Emerging Opportunities in South America. Presentation to IAEA Consultants Meeting, Vienna, July 21-25, 2008.
- [253] DUARTE, C.L., et al. Studies of cellulose from sugarcane bagasse hydrolysis using electron beam accelerator. Submitted to: International Meeting on Radiation Processing – IMRP 2008. London, UK, (September 2008).
- [254] CARDOSO, V.M., et al. Degradation of polysaccharides from sugarcane bagasse using electron beam accelerator. Submitted to: IRAP 2008 - 8th International Symposium on Ionizing Radiation and Polymers. Angra dos Reis, Rio de Janeiro, Brazil (October 2008).
- [255] STEPANIK, T. M., RAJAGOPAL, S., EWING, D. and WHITEHOUSE, R. Electron-Processing Technology: A Promising Application for the Viscose Industry. *Radiation Physics and Chemistry*, vol. **52**, nos. 1-6 (1988) 505-509.
- [256] CLELAND, M. R., et al. A Rhodotron Electron Beam Facility for Pre-Treatment of Cellulosic Pulp. Conference on the Applications of Accelerators in Research and Industry (CAARI), AIP Conference Proceedings CP475 (1999), American Institute of Physics.
- [257] TRUMP, J. G. High Energy Electron Treatment of Water, US Patent 3,901,807 (August 26, 1975).
- [258] TRUMP, J. G., MERRILL, E. M. and WRIGHT, K. A. Disinfection of Sewage Waste Water and Sludge by Electron Treatment, *Radiation Physics and Chemistry* **24** no. 1 (1984) 55-66.
- [259] BRYAN, E. H., et al. Radiation energy treatment of water, wastewater and sludge. American Society of Civil Engineers, New York, NY (1992).
- [260] COOPER, W. J., CURRY, R. D. and O'SHEA, K. E. (editors) **Environmental Applications of Ionizing Radiation**. John Wiley & Sons, New York, NY (1998).
- [261] SAMPA, M. H. O., RELA, P. R. and DUARTE, C. L. Industrial Wastewater Treatment in Brazil Using an Electron-Beam Accelerator, **Environmental Applications of Ionizing Radiation**, John Wiley & Sons, Inc., NY (1998) 521-530.
- [262] KURUCZ, C. Economics, Technology Development, Research Needs for E-Beam Water Treatment, **Proceedings of a Workshop on Applications of Ionizing Radiation for Decontamination of Environmental Resources**, National Science Foundation, Environmental Engineering Program, Washington, DC (1994) 79-89.
- [263] SCHUETZ, M. N. and VROOM, D. A. The use of high-power, low-energy electron beams for environmental remediation, **Environmental Applications of Ionizing Radiation**, John Wiley & Sons, Inc., NY (1998) 63-82.
- [264] RELA, P. R., et al. Development of an up-flow irradiation device for electron beam wastewater treatment. *Radiation Physics and Chemistry* **57** (2000) 657-660.

-
- [265] HAN, B., et al. Electron beam treatment of textile dyeing wastewater: operation of pilot plant and industrial plant construction, *IAEA-TECDOC-1473 Radiation treatment of gaseous and liquid effluents for contaminant removal* (December 2005) 101-110.
- [266] KIM, D., et al. Method for treating wastewater containing hazardous matter using electron beam irradiation. US Patent 6,121,507 (September 19, 2000).
- [267] MACHI, S., et al. Radiation treatment of combustion gases. *Radiation Physics and Chemistry* **9** (1977) 371-388.
- [268] MACHI, S. Radiation technology for environmental conservation. *Radiation Physics and Chemistry* **22** (1983) 91-97.
- [269] CHMIELEWSKI, A. G., ILLER, E., TYMINSKI, B., ZIMEK, Z. and LICKI, J. Flue gas treatment by electron beam technology, *Modern Power Systems*, (May, 2002) 53-55.
- [270] CHMIELEWSKI, A. G., et al. Operational experience of the industrial plant for electron beam flue gas treatment. *Radiation Physics and Chemistry*, **71**, 1-2 (2004) 441-444.
- [271] CHMIELEWSKI, A. G. Industrial applications of electron beam flue gas treatment—From laboratory to the practice. *Radiation Physics and Chemistry*, **76**, 8-9 (2007) 1480-1484.
- [272] GENLI, L., et al. Present status and development of an electron-beam treatment process of combustion flue gases in China. **Environmental Applications of Ionizing Radiation**, John Wiley & Sons, Inc., NY (1998) 113-121.
- [273] TOKUNAGA, O. Electron-beam technology for purification of flue gas. **Environmental Applications of Ionizing Radiation**, John Wiley & Sons, Inc. (1998) 108.
- [274] BEREJKA, A. J., CLELAND, M. R., GALLOWAY, R. and GREGOIRE, O. X-ray Curing of Composite Materials. *Nuclear Instruments and Methods in Physics Research B* **241** (2005) 847-849.
- [275] BEREJKA, A. J. Barriers to the commercial acceptance of radiation processing in the manufacture of fiber reinforced composites. SAMPE conference, Baltimore, MD (June 2007).
- [276] HERER, A., GALLOWAY, R.A., CLELAND, M.R., BEREJKA, A.J., MONTONEY, D., DISPENZA, D., and DRISCOLL, M. X-ray-cured carbon-fiber composites for vehicle use. *Radiation Physics and Chemistry* **78** (2009) 531-534.
- [277] COQUERET, X., KRZEMINSKI, M., PONSAUD, P., and DEFOORT, B. Recent advances in electron-beam curing of carbon fiber-reinforced composites. *Radiation Physics and Chemistry* **78** (2009) 557-561.
- [278] GIOVEDI, C., MACHADO, L.D.B., AUSGUSTO, M., PINO, E.S. and RADINO, P. Evaluation of the mechanical properties of carbon fiber after electron beam

-
- irradiation. *Nuclear Instruments and Methods in Physics Research B* **236** (2005) 526-530.
- [279] GIOVEDI, C., MACHADO, L.D.B., PINO, E.S., AUSGUSTO, M. and CARVALHO, O. Effects of electron beam irradiation on carbon fiber tensile properties. 2nd International Symposium on Utilization of Accelerators, Dubrovnik, Croatia (2005). IAEA-CN-115-29.
- [280] PINO, E.S., MACHADO, L.D.B. and GIOVEDI, C. Improvement of carbon fiber surface properties using electron beam irradiation. *Nuclear Science and Techniques*, Vol. **18**, No.1 (2007) 39-41.
- [281] GIOVEDI, C., MACHADO, L.D.B. and PINO, E.S.. “Thermal behavior of electron beam irradiated carbon fiber composite”. In: 2007 International Nuclear Atlantic Conference - INAC 2007 (2007), Santos-SP, on CD-ROM.
- [282] SEGUCCI, T., et al, HT-CMC-1, (1993) Bordeaux, 51; *Journal of the American Ceramic Society*. Am. Ceramic. Soc., (1995) 78, p. 1013.
- [283] YOSHIDA, M., et al., Japanese Patent, filed no. 2008-049319.
- [284] CHEN, J., WU, Z., YANG, L., ZHANG, Q. and SUN, J. Grafting copolymerization of *N,N*-dimethylacrylaminoethylmethacrylate (DMAEMA) onto pre-irradiated polypropylene films. *Radiation Physics and Chemistry* **76** (2007) 1367-1370.
- [285] MUTO, F., OSHIMA, A., KAKIGI, T., MITANI, N., MATSUURA, A., FUJII, K., SATO, Y., LI, J. and WASHIO, M. Synthesis and characterization of PEFC membranes based on fluorinated-polymer-alloy using pre soft-EB grafting method. Advanced Research Institute for Science and Engineering (RISE), Waseda University, Tokyo, Japan (2005).
- [286] SILVA, D.F., OLIVEIRA NETO, A., PINO, E.S., BRANDALISE, M., LINARDI, M., and SPINACÉ, E.V. PtRu/C electrocatalyst prepared using electron beam irradiation. *Materials Research*, **10**, (2007) 367-370.
- [287] SILVA, D. F., OLIVEIRA NETO, A., PINO, E. S., BRANDALISE, M., LINARDI, M. and SPINACÉ, E.V. PtRu/C electrocatalysts prepared using electron beam irradiation. In: 2007 International Nuclear Atlantic Conference - INAC 2007, 2007, Santos-SP. 2007 INAC - International Nuclear Atlantic Conference, 2007. v. CD-ROM.
- [288] SEGUCHI, T. *Radiation Physics and Chemistry* **57** (2000) 367.
- [289] ZAGO, C. and RELA, P. R. Technical feasibility for electron beam application on maize seeds disinfection for maize cultivation in Brazil. In: 2007 International Nuclear Atlantic Conference - INAC 2007, 2007, Santos-SP. 2007 v. CD-ROM.
- [290] BORCEAN, I. Results obtained at the University of Agricultural Science and Veterinary Medicine of the Banat in Timisoara, Romania. <http://www.eventus.de/index.php?setlang=en>.
- [291] TSAI, D. and RELA, P. R. Aplicação da radiação por feixe de elétrons com agente

-
- esterilizante de microorganismos em substrato turfoso (*Application of electron beam radiation for peat sterilization and suppression of microbe contaminants*). Dissertação (Mestrado) – Instituto de Pesquisas Energéticas e Nucleares. São Paulo, Brasil. 2006.
- [292] TSAI, S.M., OLIVEIRA, W.S., TSAI, D., RELA, P.R., and SAMPA, M.H.O. Inoculantes promovem economia na produção de soja (*Inoculants have promoted economy in the soybean production*). *Visão Agrícola* nº 5, p. 31-34, Ano 3, Jan/Jun 2006.
- [293] BOURROUL, S. C., HERSON, M. R., PINO, E. S. and MATHOR, M. B. Sterilization of skin allografts by ionizing radiation. *Cellular and Molecular Biology* **48** (7), (2002) 803-807.
- [294] DZIEDZIC-GOCLAWSKA, A., et al. Irradiation as a safety procedure in tissue banking. *Cell and Tissue Banking* **6** (2005) 201–219.
- [295] RADTECH INTERNATIONAL NORTH AMERICA Food Packaging Alliance. See: www.radtech.org/Industry/food.htm.