



MECHANICAL SEALS

- Technical manual -

In collaboration with
EagleBurgmann
Rely on excellence



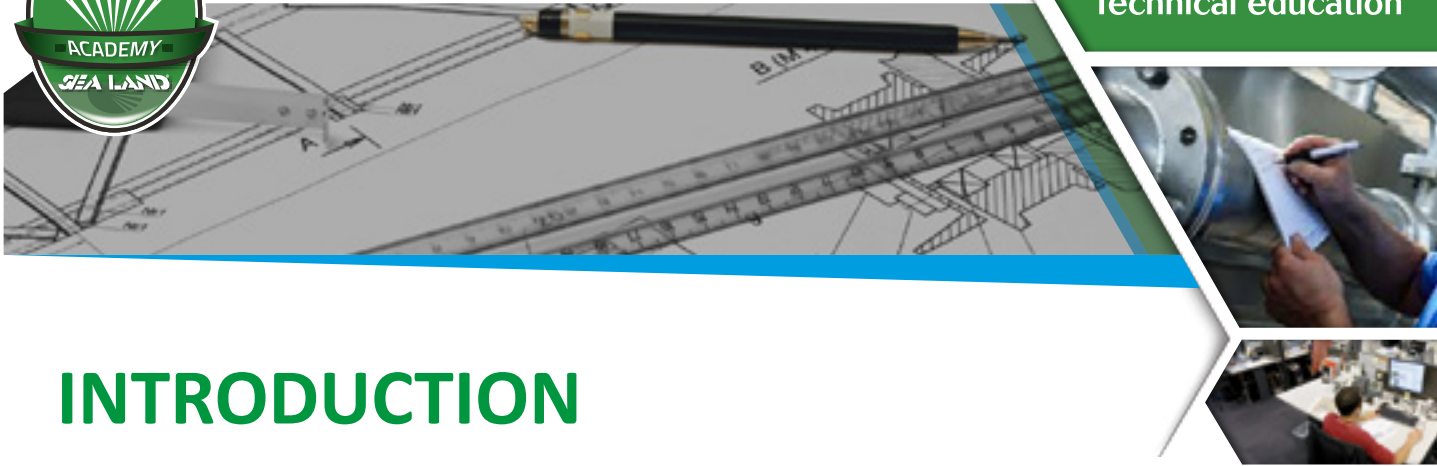

INTRODUCTION

What you are going to read is the very first e-book arising from Sea-Land Academy program.

Sea Land has set up the Academy program at the beginning of 2017 mainly to:

- **support**, in cooperation with both centers of excellence and qualified experts, the never-ending professional evolution required from the market. The even faster technical, economic and social innovation all over the world does need a new business model connecting the work experience to the academic learning. The result of such contamination is a professional skillset which does increase the value of Human Capital;
- **promote** the know-how acquired through our Value Chain, our distributors and suppliers too, to set up a strategic long-term cooperation.

These are the reasons why we planned a class about Mechanical Seals. Our special thanks to Eagle Burgmann BT company, and Eng. Costa, CEO of BT, for sharing with us an important know-how and being a reliable Sea Land partner for many years. We feel honored of such cooperation. We feel also inspired to give our customers an even higher service over the time.

Last, this e-book has been set up for those who already operate in the electric pump industry. You can find in it a wide overview of products

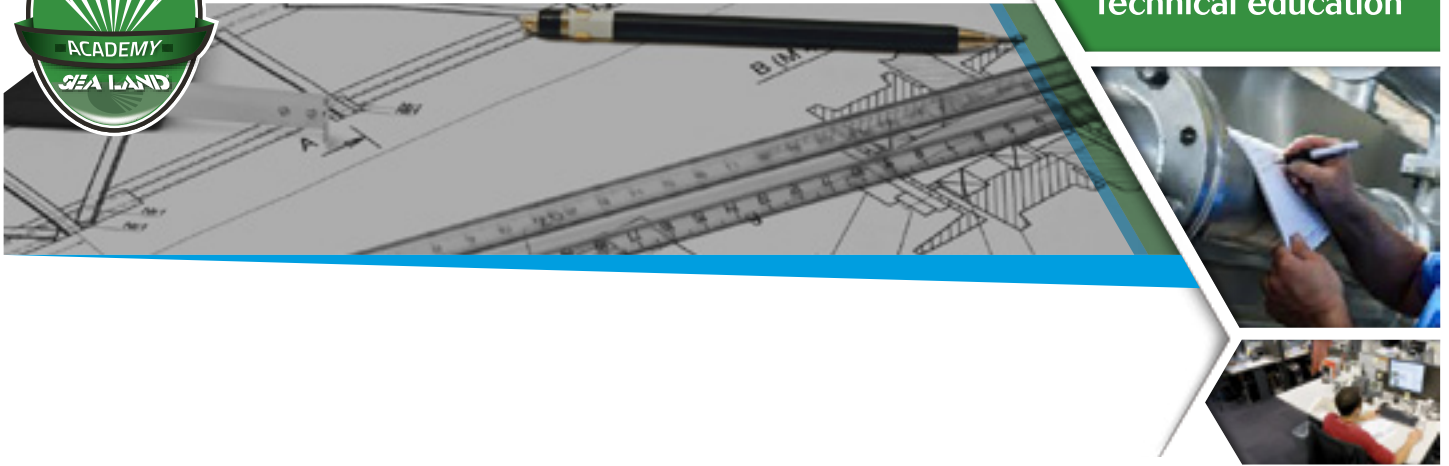

Innovation and Technical education

suitable for the most different needs, as well as general and technical information. Furthermore, some examples, if any, of specific applications of our products are included.

Both our Technical and Sales Departments remain at your disposal for any information you might need.

Enjoy!





INDEX

| | |
|-----------------------------------------------------------------------|-----------|
| 1. WHAT IS A MECHANICAL SEAL | 6 |
| 1.2 Traditional methods | 6 |
| 1.3 Design | 7 |
| 1.4 Sealing Points | 8 |
| 1.5 Leakage | 9 |
| | |
| 2. MECHANICAL SEALS PROPOSED | 10 |
| | |
| 3. SEAL FACE MATERIALS | 24 |
| 3.1 Carbon-graphite | 24 |
| 3.2 PTFE | 28 |
| 3.3 Aluminium Oxide | 30 |
| 3.4 Steatite | 32 |
| 3.5 Cemented carbides | 33 |
| 3.6 Silicon carbide | 36 |
| 3.7 Other materials | 39 |
| 3.8 Materials properties | 40 |
| 3.9 "PV" factor | 41 |
| | |
| 4. SECONDARY SEAL MATERIALS | 44 |
| 4.1 Elastomers | 44 |
| 4.2 Wrapped elastomers | 49 |
| 4.3 Non elastomers | 54 |
| | |
| 5. MATERIALS CODES IN ACCORDANCE TO EUROPEAN STANDARD EN 12756 | 55 |
| | |
| 6. OPERATING MANUAL | 56 |

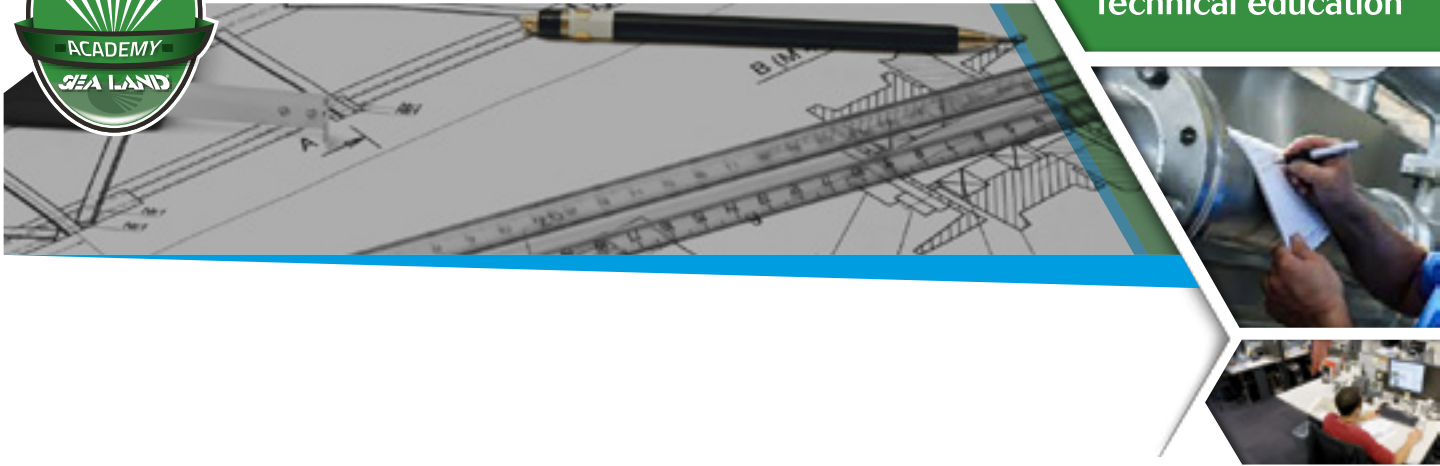

| | |
|------------------------------------------------|-----------|
| 6.1 Object and application field | 56 |
| 6.2 Safety | 57 |
| 6.3 European directives | 59 |
| 6.4 Operating limits | 60 |
| 6.5 Temperature limits for elastomers | 62 |
| 6.6 Working conditions | 63 |
| 6.7 Emissions (leakages) | 63 |
| 6.8 Transport | 64 |
| 6.9 Storage | 65 |
| 6.10 Preliminaries to assembly | 67 |
| 6.11 Utilities and tools | 69 |
| 6.12 Assembly | 69 |
| 6.13 Direction of rotation | 73 |
| 6.14 Start up | 74 |
| 6.15 Workers protection | 75 |
| 6.16 Troubles during operation | 75 |
| 6.17 Maintenance | 76 |
| 6.18 Repair | 76 |
| 6.19 Seal removal | 77 |
| 6.20 Disposal instruction | 78 |
| 7. TECHNICAL ASSISTANCE AND INFORMATION | 79 |
| 8. BIBLIOGRAPHY | 80 |



1. WHAT IS A MECHANICAL SEAL

A mechanical seal is a method of containing fluid within a vessel (typically pumps) where a rotating shaft passes through a stationary housing or occasionally, where the housing rotates around the shaft.

When sealing a centrifugal pump, it's essential to allow a rotating shaft to enter the 'wet' area of the pump, without allowing for pressurized fluid to escape.

For this problem, there needs to be a seal between the shaft and the pump housing that can contain the pressure of the process being pumped and withstand the friction caused by the shaft rotating.

1.1 Traditional Methods

Another method of forming this seal is to use Gland Packing. It is a rope-like material that packed around the shaft, stuffing the gap between the shaft and the pump housing.

Although Gland packing is a very used material, mechanical seals are becoming a world standard for these reasons:

- The friction of the shaft rotating wears away at the packing over time, which leads to increased leakage until the packing is adjusted



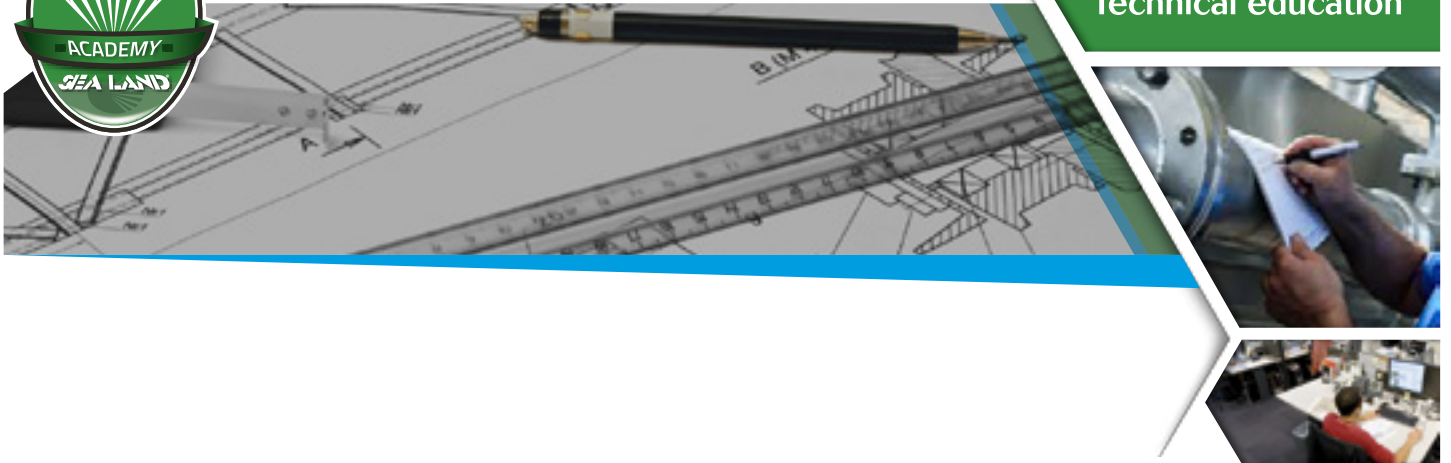

or re-packed.

- The friction of the shaft also means that packing also needs to be flushed with large volumes of water in order to keep it cool.
- Packing needs to press against the shaft in order to reduce leakage – this means that the pump needs more drive power to turn the shaft, wasting energy.
- Because packing needs to contact the shaft it will eventually wear a groove into it, which can be costly to repair or replace.

Mechanical seals are designed to overcome these drawbacks.

1.2 Design

An essential mechanical seal contains three sealing points.

1. The stationary part of the seal is fitted to the pump housing with a static seal –this may be sealed with an o-ring or gasket clamped between the stationary portion and the pump housing.
2. The rotary portion of the seal is sealed onto the shaft usually with an O ring. This sealing point can also be regarded as static as this part of

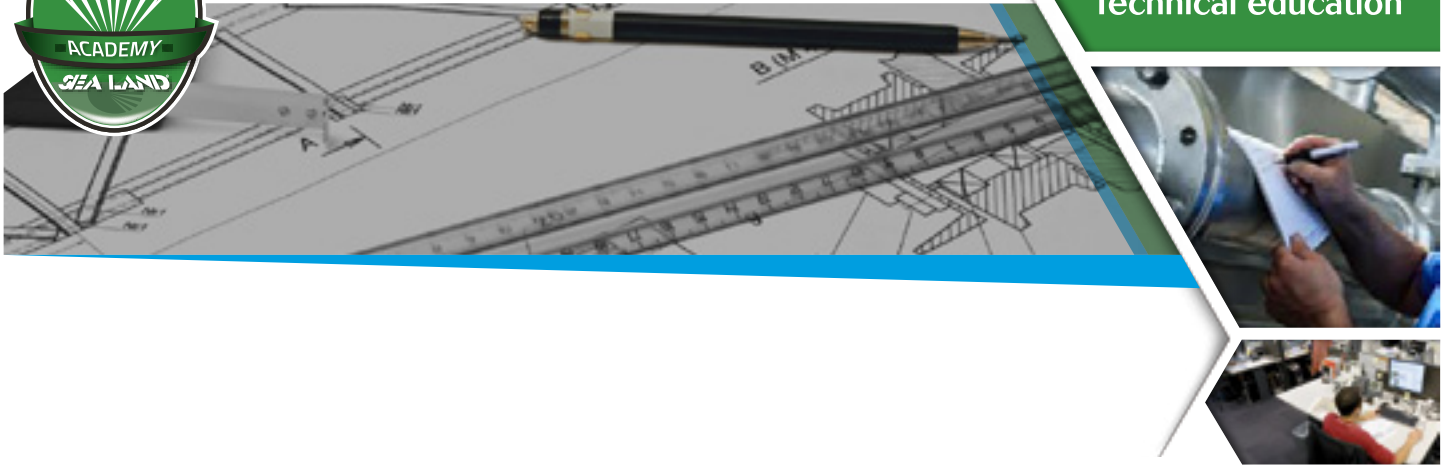

the seal rotates with the shaft.

The mechanical seal itself is the interface between the static and rotary portions of the seal.

3. One part of the seal, either to static or rotary portion, is always resiliently mounted and spring loaded to accommodate any small shaft deflections, shaft movement due to bearing tolerances and out-of-perpendicular alignment due to manufacturing tolerances.

1.3 Sealing Points

While two of the sealing points in a seal design are statics, the seal between the rotating and stationary members is more critical. This primary seal is the basis of all seal design and is essential to its effectiveness.

The primary seal is essentially a spring-loaded vertical bearing consisting of two extremely flat faces, one fixed, one rotating, running against each other. The seal faces are pushed together using a combination of hydraulic force from the sealed fluid and spring force from

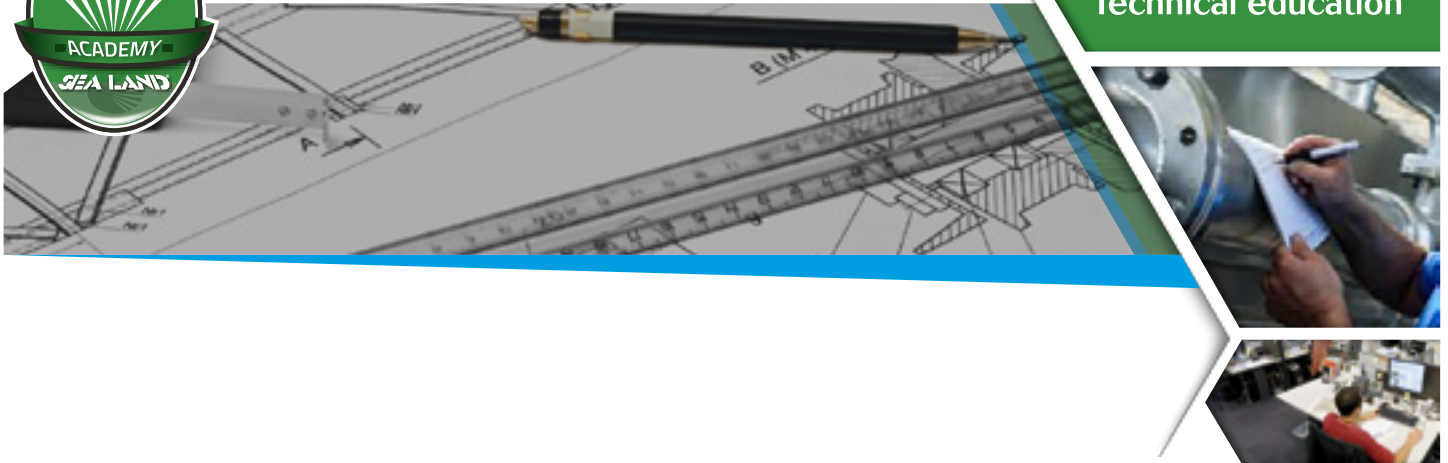

the seal design. In this way, a seal is formed to prevent process leaking between the rotating and stationary areas of the pump.

If the seal faces rotated against each other without some form of lubrication, they would wear and quickly fail due to face friction and heat generation. For this reason, lubrication is required between the rotary and stationary seal face; this is known as the fluid film.

1.4 Leakage

When we talk about leakage, we are referring to visible leakage of the seal. This is because a very thin fluid film holds the two seal faces apart from each other. By maintaining a micro-gap, a leak path is created making it impossible for a mechanical seal to be totally leak free. For this, is that unlike gland packing, the amount of leakage on a mechanical seal should be visually undetectable.





2. MECHANICAL SEALS PROPOSED

BT-AR

Mechanical seal for large-series cold water pumps, produced in millions of units per year. The BT-AR owes its success to the wide range of application, the short axial length (this allows for more economic pump construction and saves material), and the best quality/price ratio.

The elasticity of the bellows design enables a more robust operation. The BT-AR can also be used as a multiple seal in tandem or back-to-back arrangement when the product media cannot ensure lubrication, or when sealing media with a higher solids content. Installation proposals can be provided upon request.

Features

- Rubber bellows mechanical seal
- Unbalanced
- Single spring
- Independent of direction of rotation
- Short axial installation length



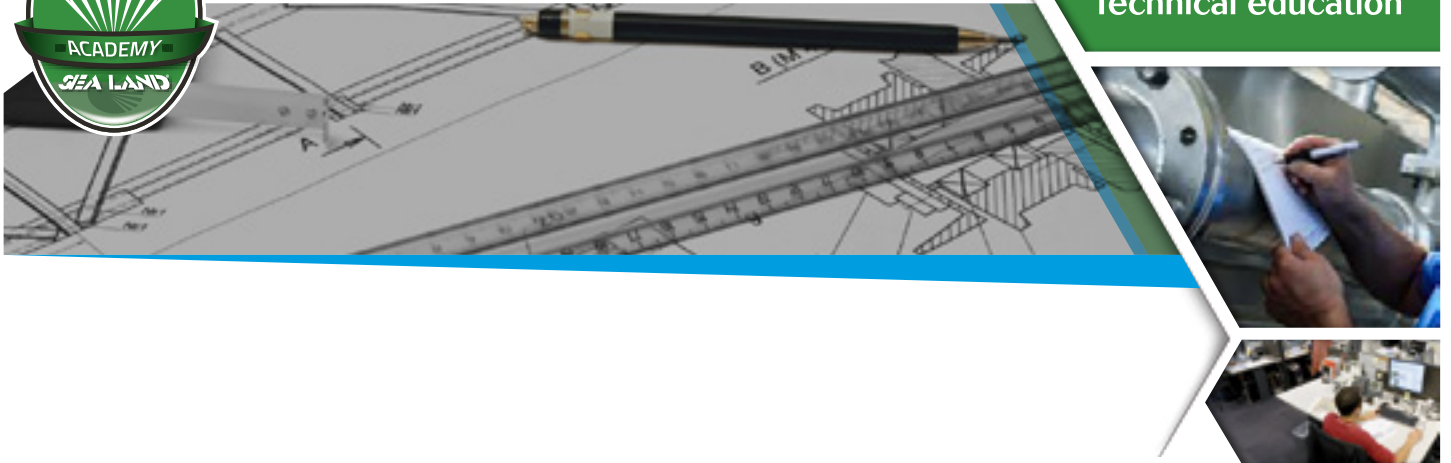

BT-A2

Stationary mechanical seal in inch dimensions. Spread throughout the world, this type of mechanical seal has reached an unsurpassed quality level. The BT-A2 features all carbon or high quality resin impregnated carbon, aluminium oxide 96 %, is stationary and the rubber bellows are glued on collar. Static air pressure test to 100 % production. Excellent solution for swimming pool pumps.

Features

- Rubber bellows mechanical seal
- Unbalanced
- Single spring
- Independent of direction of rotation
- Stationary design



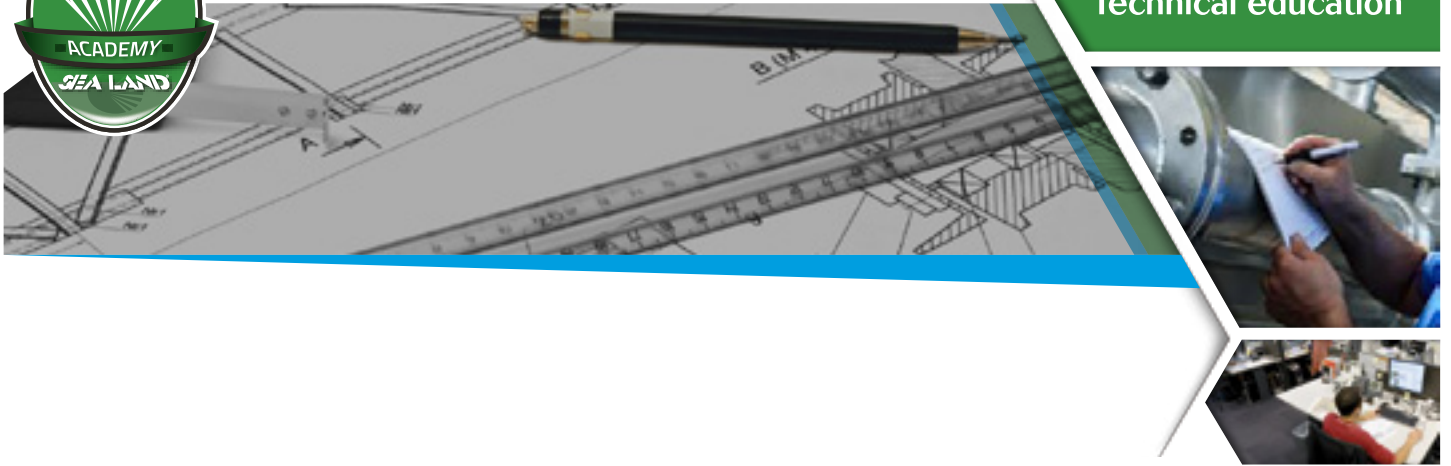

BT-ARP

BT-ARP mechanical seals are the ideal solution for media which contain solids or are highly viscous. The spring is product-protected, thus preventing sticking or clogging. Reliable for rugged operation in all kind of applications such as waste water treatment. The dimensions can be adapted and additional seats are available. The bellows provides protection across the entire seal length.

Features

- Rubber bellows mechanical seal
- Independent of direction of rotation
- Single spring, product-protected
- Unbalanced



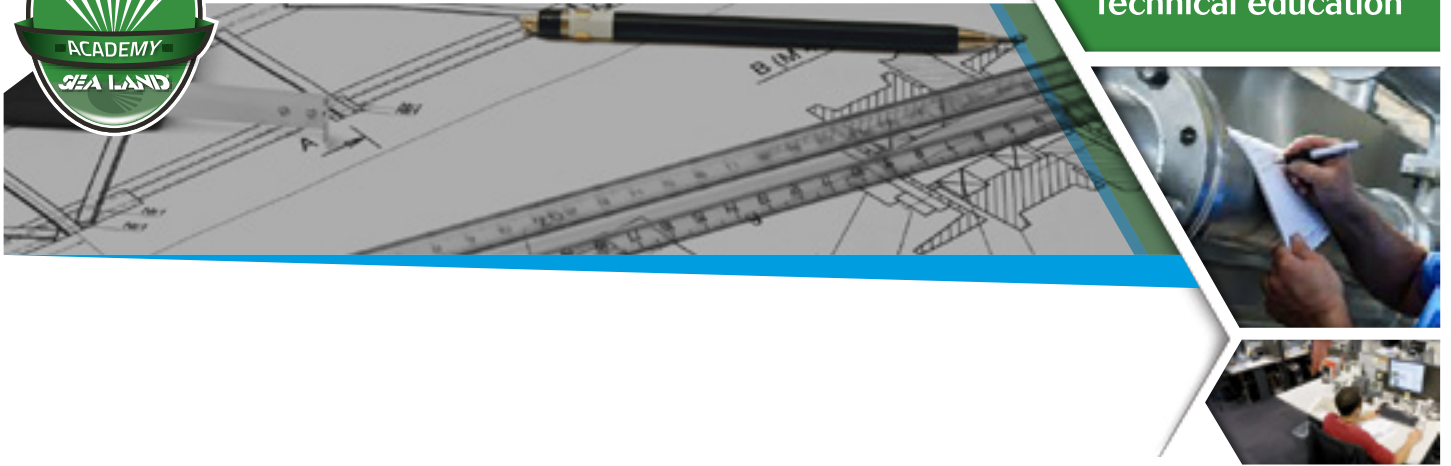

BT-A2

The BT-PN is a large series mechanical seal with a simple yet effective design that is easy to assemble. The special spring arrangement allows a short axial installation length.

This advantage is combined with an increased working pressure capability of up to 12 bar (174 PSI). The spring is free from torque transmission.

Features

- Rubber bellows mechanical seals
- Unbalanced
- Single spring
- Independent of direction of rotation



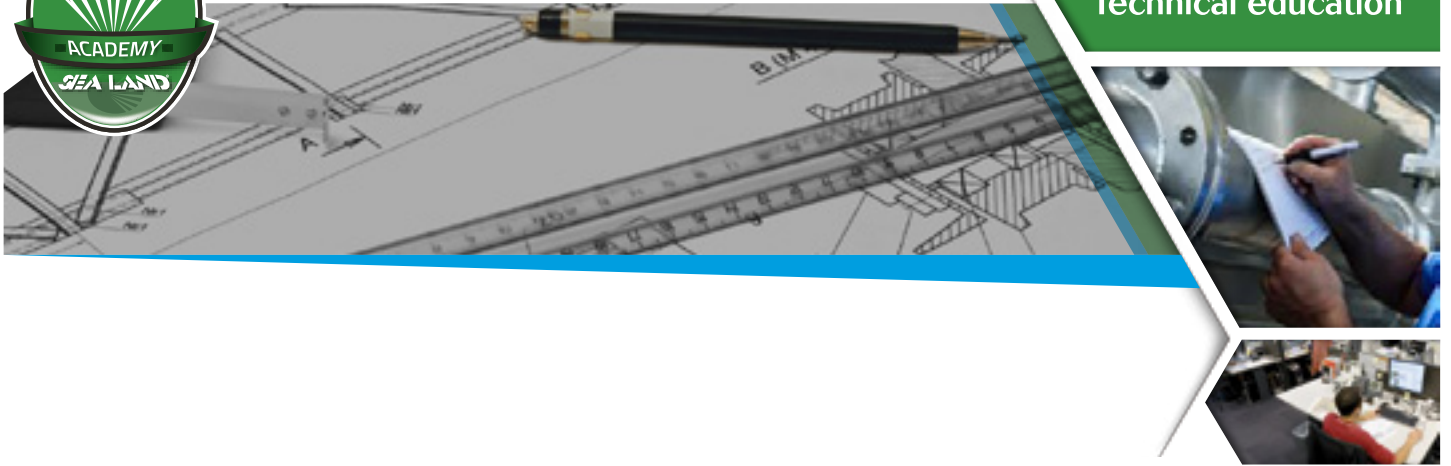

BT-PNT

The main design features of the BT-PNT are the metal joint torque transmission together with the rubber bellows.

This prevents torsional effects on the bellows. The shaft is protected across the entire seal length. Easy to assemble, the BT-PNT guarantees a long service life due to good product turbulence.

Features

- Rubber bellows mechanical seal
- Unbalanced
- Single spring
- Independent of direction of rotation



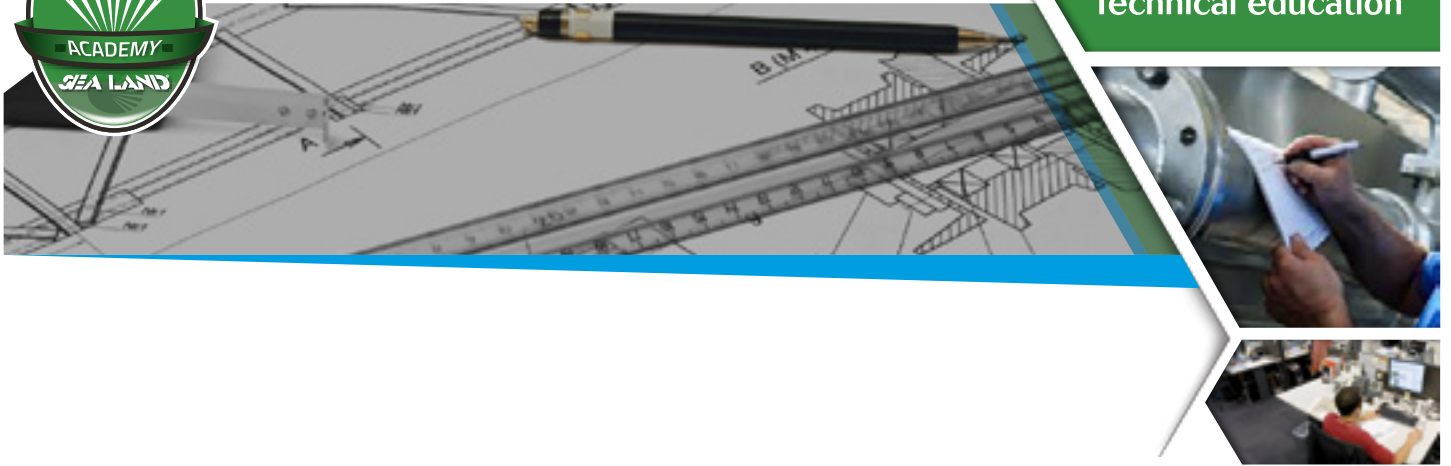

BT-RN

The BT-RN represents the traditionally designed robust pusher seal. This type of mechanical seal is easy to install and covers a wide range of applications; its reliability has been proven by millions of units in worldwide operation.

It is a convenient solution for the widest range of applications: for clean water as well as chemical media.

Features

- Single pusher-type seal
- Unbalanced
- Conical spring
- Dependent on direction of rotation



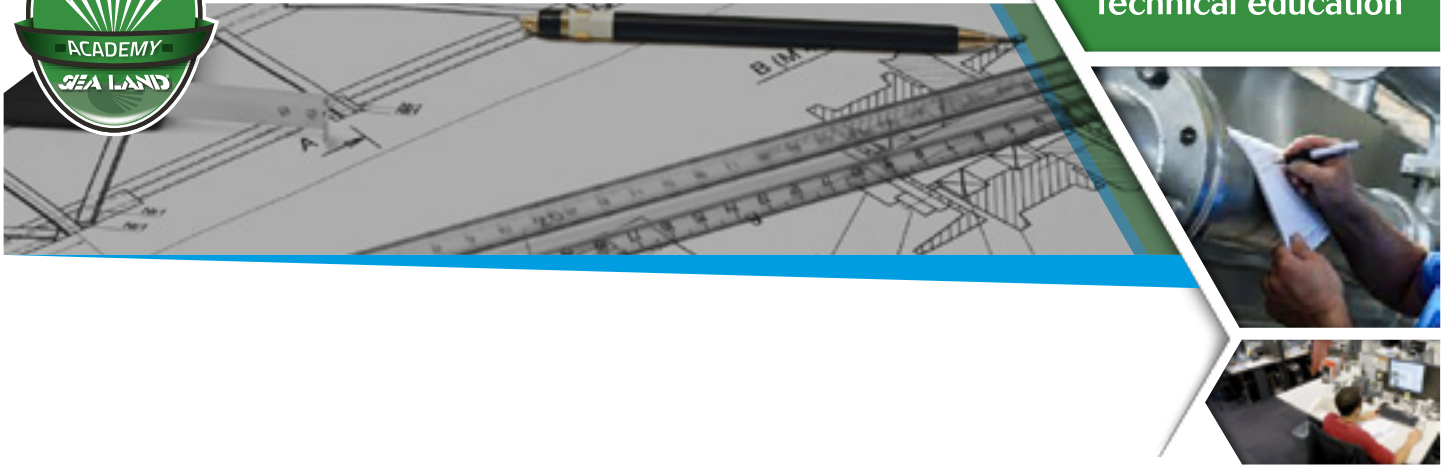

BT-RN.(Balanced version)

The BT-RN.NB/KB represents a traditional pusher seal and is the balanced version of a BT-RN. Designed for high pressure fluids, it is made from the same material range as the BT-RN. The main characteristic is a short design combined with an economical seal solution. Length and dimensions according to EN 12756 (RN.NB normal length, RN.KB short length).

Features

- Single pusher-type seal
- Balanced
- Conical spring
- Dependent on direction of rotation
- Short length (KB)
- Normal length (NB)



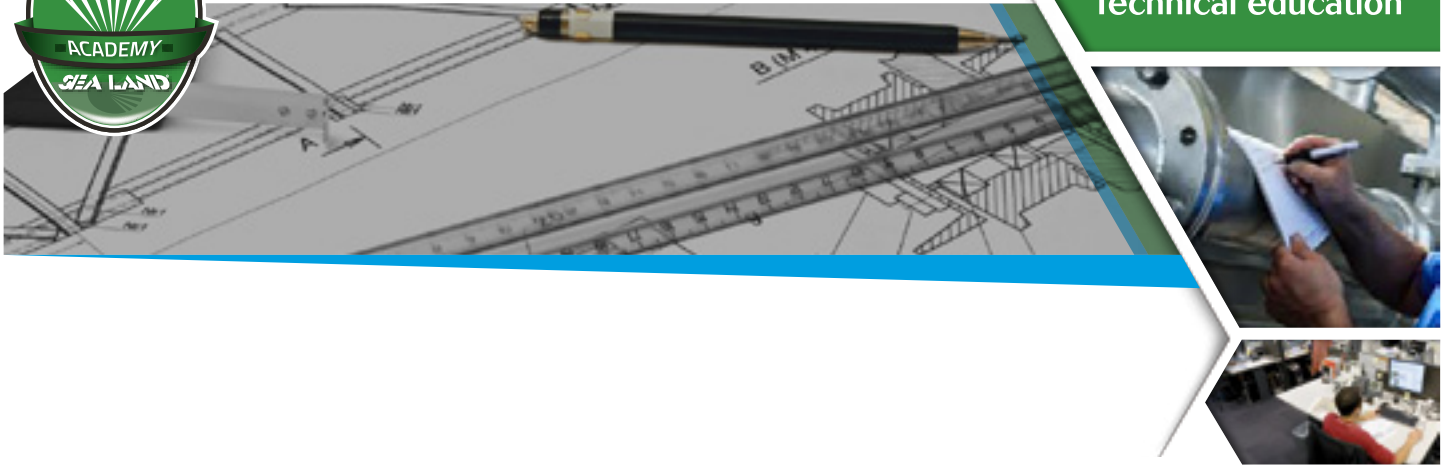

BT-FN

The BT-FN combines a spring loaded ceramic seal face and the traditional pusher mechanical seals. The competitive price and the wide range of applications have made the BT-FN seal a success. The seal is produced with punched metal parts that allow an economical design. BT-FN mechanical seals are also the ideal solution for light chemicals media applications. To ensure the best reliable performance, we recommend a material combination of hard material sliding faces and proper elastomer o-rings.

Features

- Single pusher-type seal
- Unbalanced
- Conical spring
- Dependent on direction of rotation



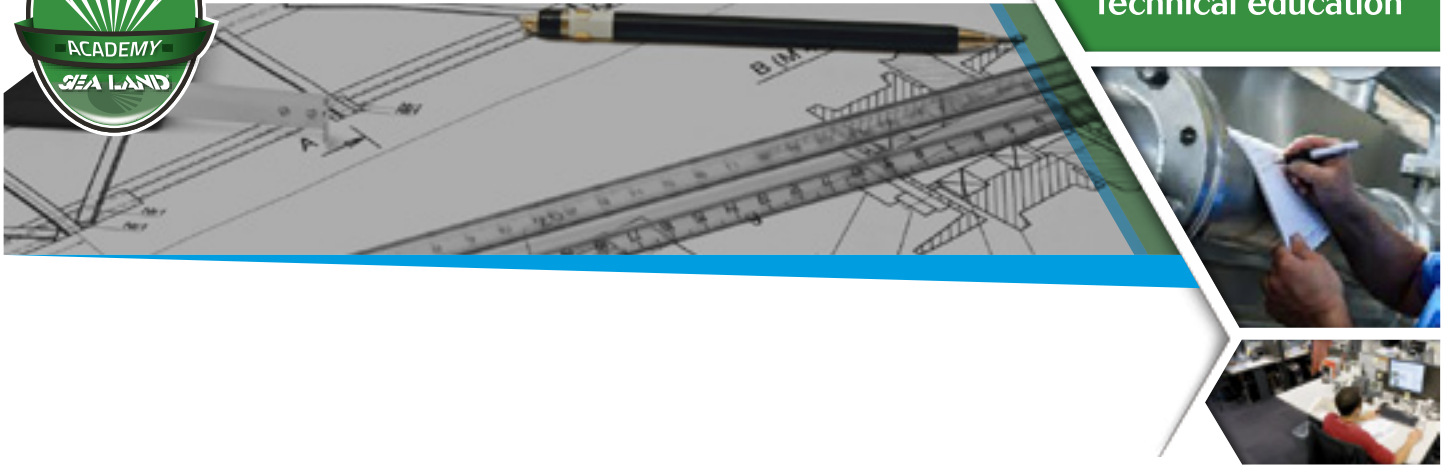

BT-FH

The BT-FH is a seal for demanding applications where operating conditions in the pump require machined metal parts for the mechanical seal. The seals are available in a full range of diameters from 10 to 100 mm and in the standard diameters specifically for chemical applications.

Features

- Single pusher-type seal
- Unbalanced
- Conical spring
- Dependent on direction of rotation



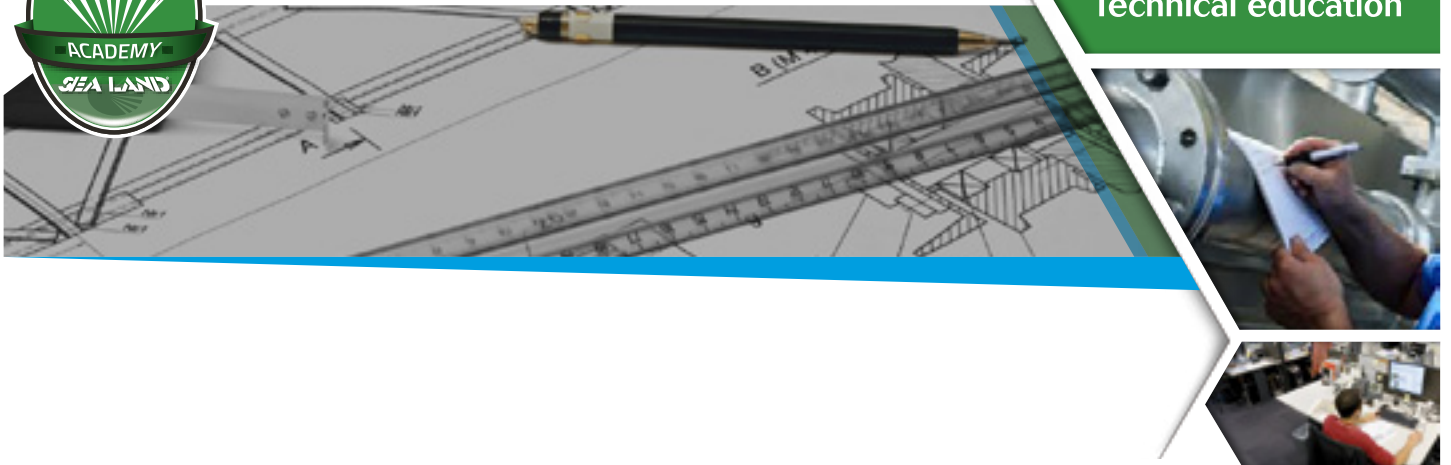

BT-FH.NB (Balanced version)

The BT-FH mechanical seal range has been designed for universal application and is ideally suited for standardization. It is a cost-effective version of a balanced seal with the added advantage of only having to replace the wearing faces during overhauls. Installation length in accordance with EN 12756 (L1NB).

Features

- Single pusher-type seal
- Balanced
- Dependent on direction of rotation
- Conical spring
- Length according to EN 12756
- Version NB (normal length, balanced L1NB)



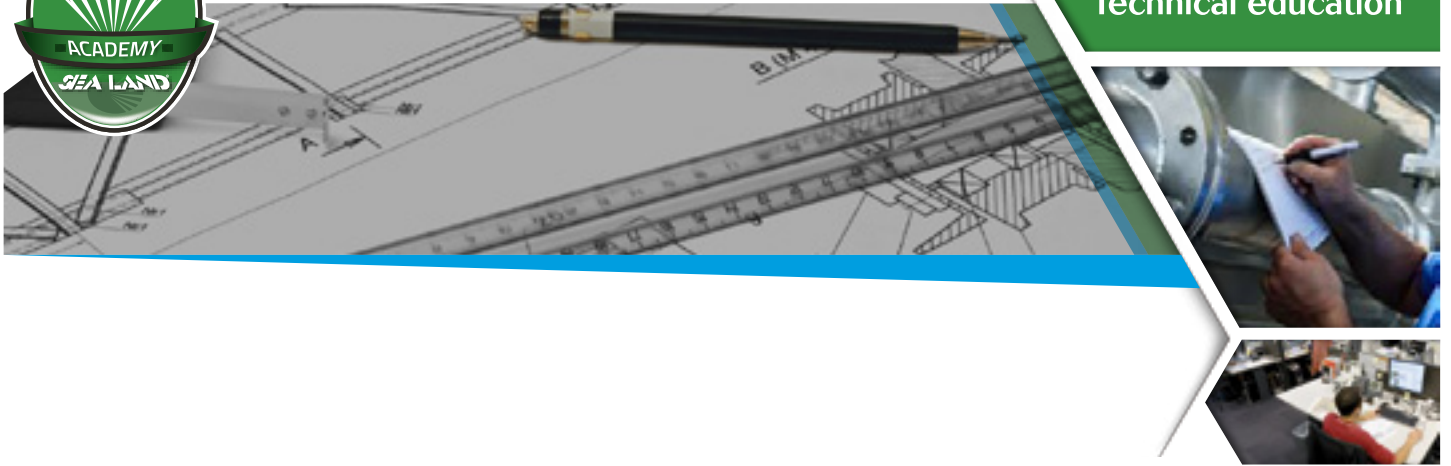

BT-C5E

The BT-C5E is designed for external mounting and is characterized by a short installation length. The advantage of a seal mounted on the outside is that all metal parts, including springs, are not in contact with the media. Torque transmission via robust axial notches on the metal collar. The collar is fixed on the shaft with set screws. Typical applications are volumetric lobe pumps for food, cosmetics and pharmaceuticals and for sticky and highly viscous media (e.g. paste, paints).

Features

- Single pusher-type seal
- Multiple springs
- Independent of direction of rotation
- External mounting
- For high viscosity media



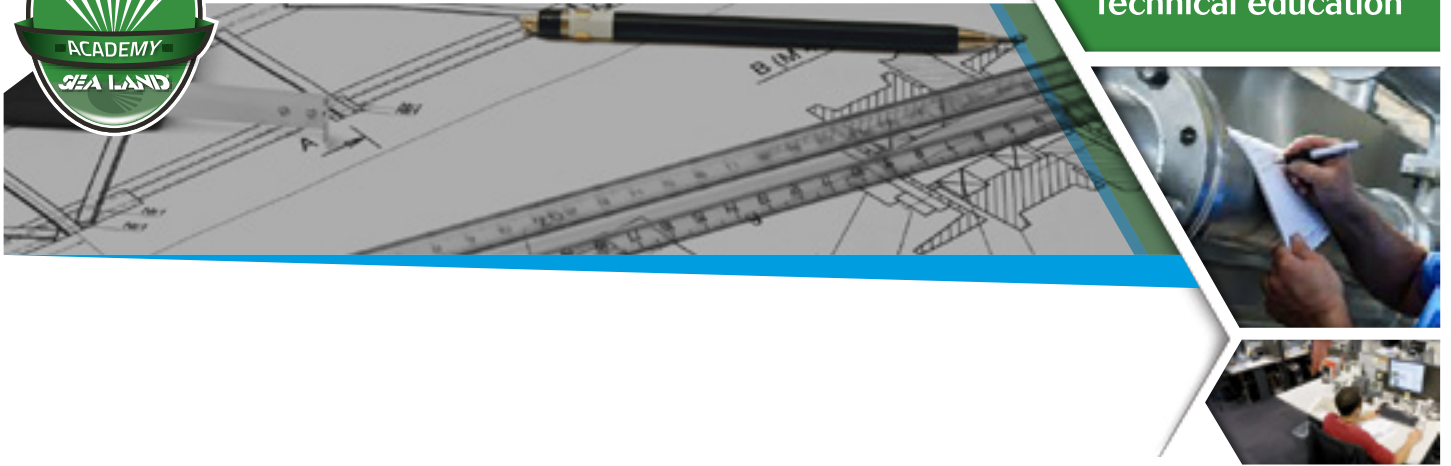

BT-C5

The BT-C5 is available in many material combinations with various application opportunities, especially in chemical applications. Torque transmission through set screws.

Dimensions according to EN 12756, short length I1K. BT-C5.KB is the balanced version of the BT-C5.KU. Suitable for a higher pressure range. Dimensions according to EN 12756, short length I1KB.

Features

- Single pusher-type seal
- Unbalanced, short length (KU)
- Balanced, short length (KB)
- Multiple springs
- Independent of direction of rotation



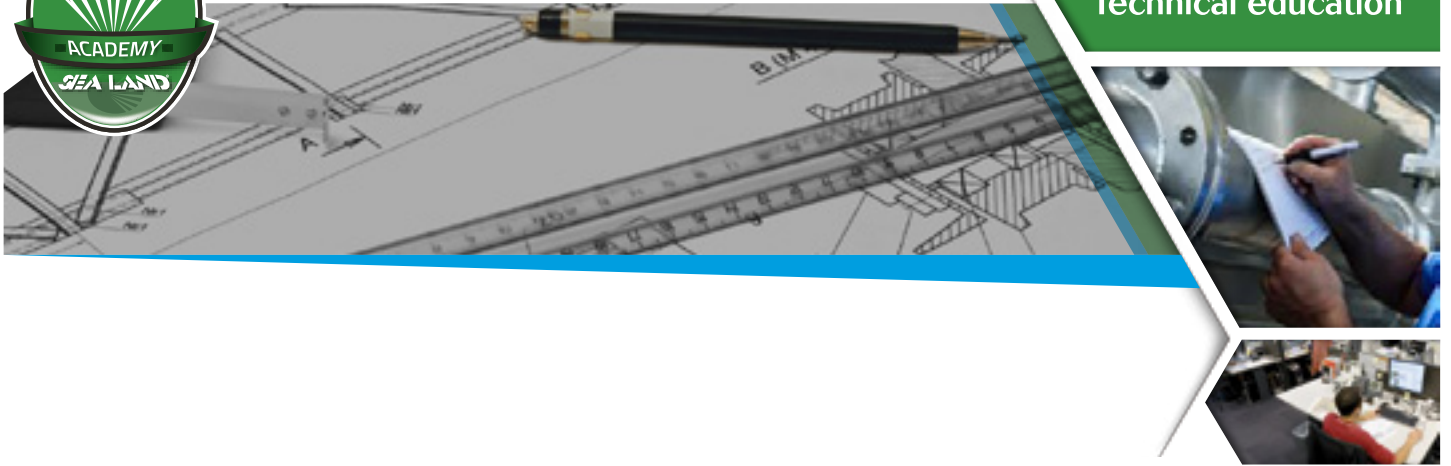

BT-C7

The BT-C7 mechanical seal range has a robust design for universal application. The seal is bi-directional, unaffected by the direction of shaft rotation and is positively driven by set screws. With super-sinus spring.

Features

- Single pusher-type seal
- Unbalanced
- Super-sinus spring
- Independent of direction of rotation
- Short length, according EN 12756 (L1KU).



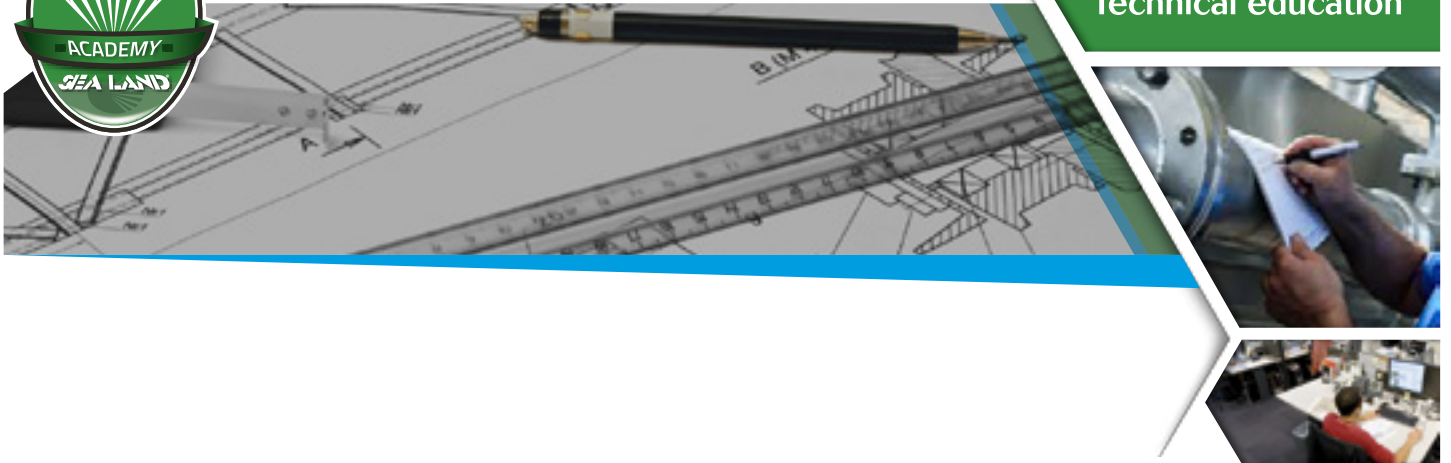

BT-C8

The BT-C8 mechanical seal range is designed for universal application and is ideally suited for standardization. The seal is bi-directional, unaffected by the direction of shaft rotation and is positively driven by set screws. With super-sinus spring. The advantages of this mechanical seal are the easily interchangeable seal faces which permit all material combinations.

Features

- Single pusher-type seal
- Unbalanced
- Independent of direction of rotation
- Super-sinus spring
- Short installation length, according EN 12756 (L1KU).



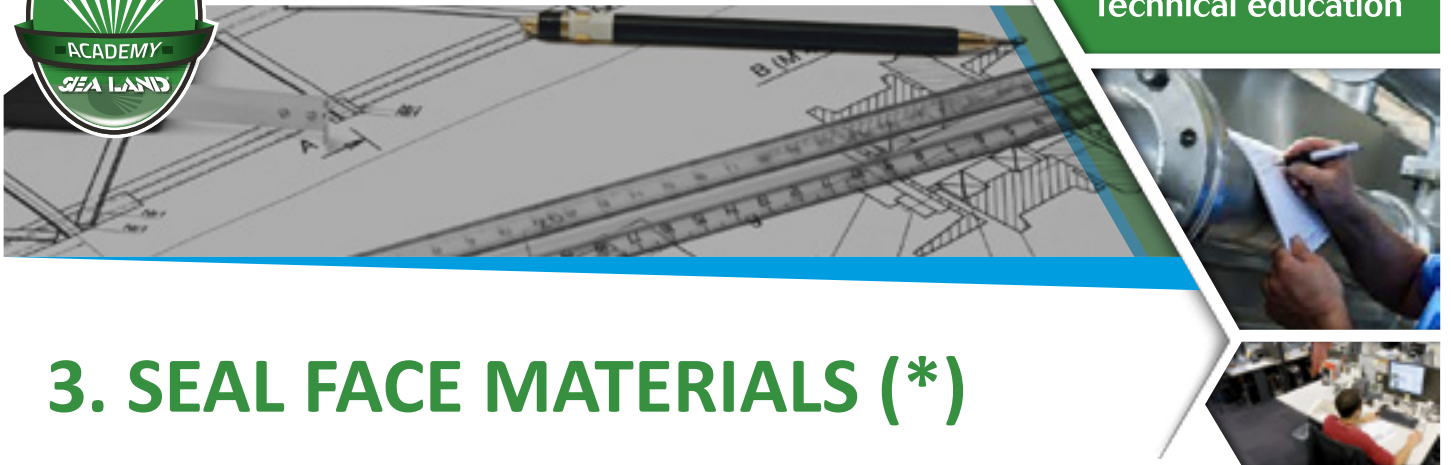

3. SEAL FACE MATERIALS (*)

The following sections describe the materials in common use and their significant properties for the seal face and the counter ring. With their opposing surfaces, the seal face and the counter ring form the sealing gap. The term “seal face” is used for the spring-backed component, “counter ring” for the component without spring backing. Seal face and counter ring are the main part of a mechanical seal and therefore special care must be given in the materials choice.

3.1 CARBON-GRAPHITE

The term “carbon-graphite”, or more colloquially “carbon” is used for a range of carbon composites that are the first choice for one of the seal faces.

ADVANTAGES:

- Good lubricating qualities under dry or boundary lubricating conditions;
- Ability to bed in quickly and take up any slight imperfections in face geometry;

(*) The characteristics and properties of the materials presented are approximate, may vary depending on the formulation of raw material.

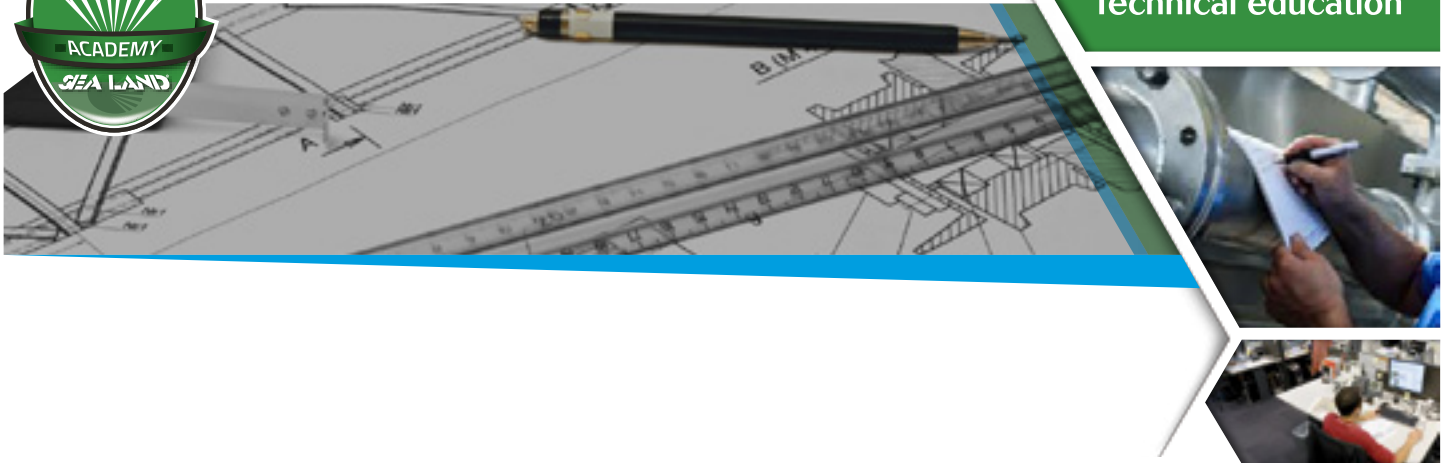

- Good chemical resistance;
- Reasonably strong in compression;
- Relatively low in cost and readily available;
- Wide temperature resistance ranging from cryogenic temperatures to 250°C; this upper limit can be extended to 350°C by using certain metalized grades.

DISADVANTAGES:

- Low tolerance with abrasives or crystallizing liquids;
- Some chemicals attack either carbon itself or the impregnant;
- Not as stiff as metals and ceramics and so tends to distort at higher pressures;
- While strong in compression carbon grades are weak under tensile stress;
- Low thermal conductivity;
- Some applications will not tolerate the risk of carbon dust entering the process; this is generally a hygiene requirement rather than a potential hazard.

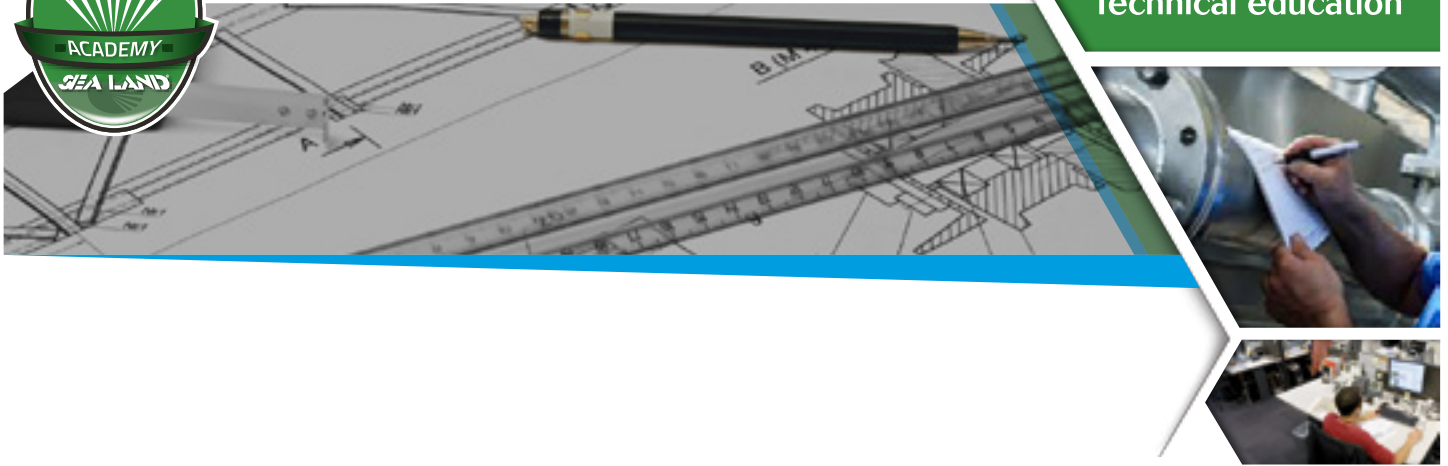

GRADES IN USE

The term carbon-graphite covers a wide range of different products. The term carbon usually refers to such products as coke, charcoal or lamp black, which are sometimes described as amorphous carbon, though they are considered to be crystalline forms of graphite. It is the graphite with its hexagonal layers molecular structure that gives carbon-graphite its self-lubricating properties, while the carbon imparts strength.

The precise manufacture of carbon-graphite grades is a commercial secret, but generally the process consists of producing a base grade by mixing carbon in some form, lamp black or coke, with natural or artificial graphite and pitch or resin to act as a binder and hold the mixture together. After mixing and forming a suitable shape, the compact is baked at about 1000°C. At this temperature the binder is converted into coke and holds the mass together. As a consequence of the baking operation the 'base grade' carbon-graphite is porous and requires impregnation to provide an impermeable material and to give excellent running properties.

Three broad categories are used:

- (1) Carbon-graphite resin impregnated
- (2) Carbon-graphite metal impregnated

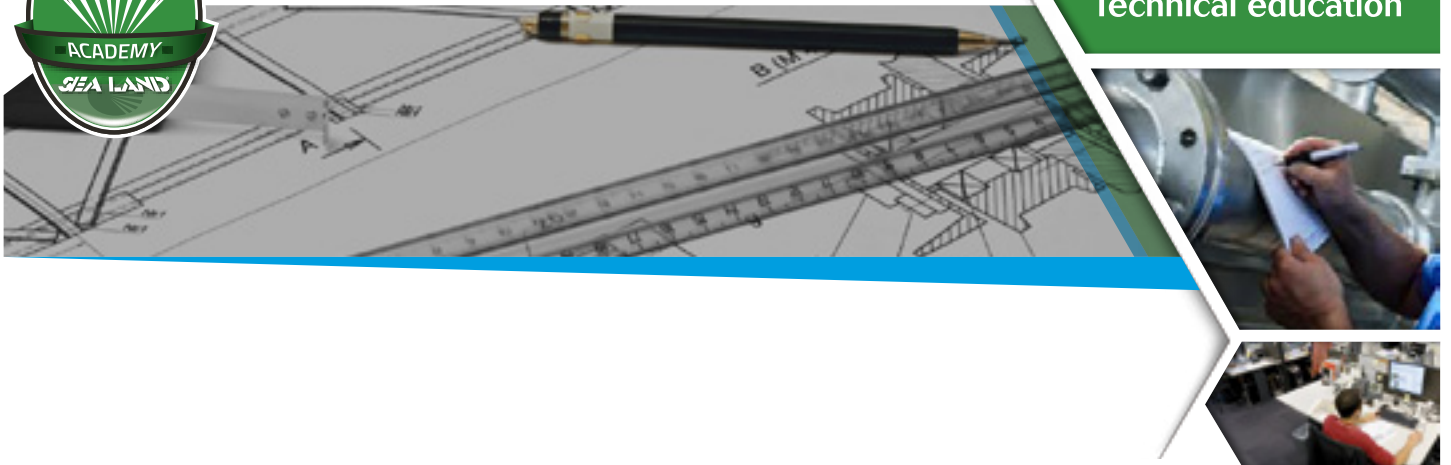

(3) Full carbon-graphite grade (without impregnant)

Carbon-graphite resin impregnated grades have a wide range of chemical resistance and better wear properties. For the impregnation a phenolic resin is used. These grades are generally less expensive than the other two grades.

The carbon-graphite metal impregnated can be impregnated with various low melting point metals such as, for example, antimony (Sb) or alloy of antimony, lead (Pb), tin (Sn).

Benefits: better mechanical properties and thermal conductivity compared to other carbon graphite.

Disadvantages: worse chemical resistance as compared to resin impregnated carbon graphite and, also, a drinking water approval and an approval for use in the food industry cannot be obtained with metal-impregnated carbon graphite.

This type of carbon-graphite is stronger than the conventional grades and, against certain counter faces gives a better running performance (ability to cope with boundary lubrication conditions). It 'also true, however, that against certain counterfaces, carbon graphite metal impregnated gives a poorer performance, often due to an electrolytic action causing the metal impregnant to "smear".

The full carbon-graphite grade, since no impregnation, is used when high temperatures (greater than 250 °C) and better chemical resistan-

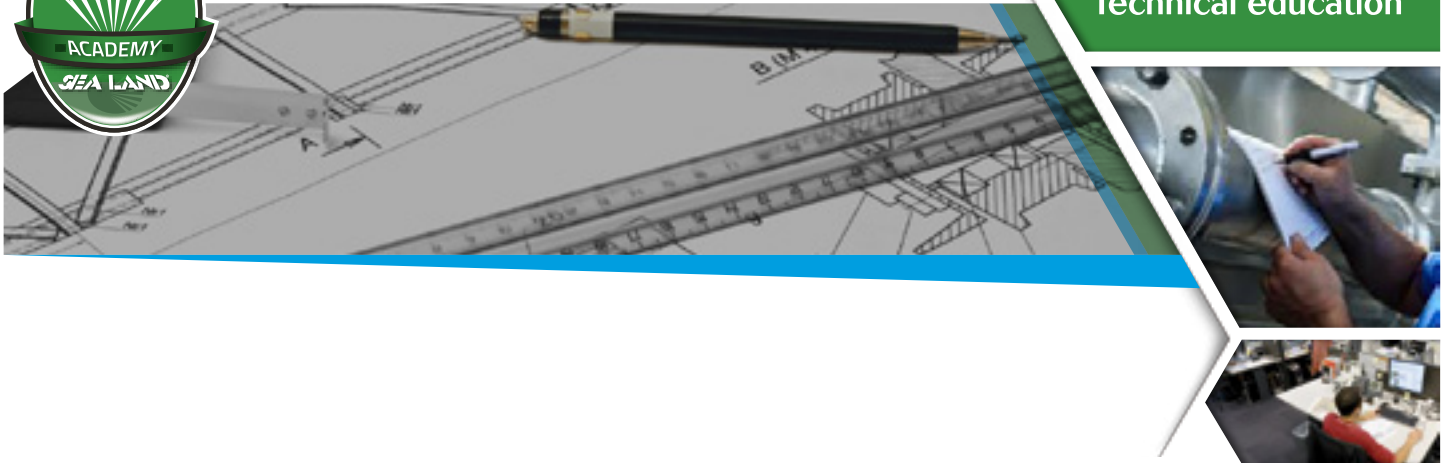

ce are required.

COUNTERFACES

The ability of carbon to run against a wide range of counter faces accounts for its extensive use in mechanical seals. Typical application is against alumina oxide rings for all-round seal for not too demanding applications, and against silicon carbide or tungsten carbide for more challenging applications.

3.2 PTFE

The self-lubricating properties of PTFE would appear to make it a good candidate for a seal face material; however because of its low strength and tendency to creep its use is restricted. Not surprisingly PTFE is used with a filler such as glass fibers to improve its mechanical properties.

ADVANTAGES:

- Good lubricating qualities;
- Reduced friction coefficient;



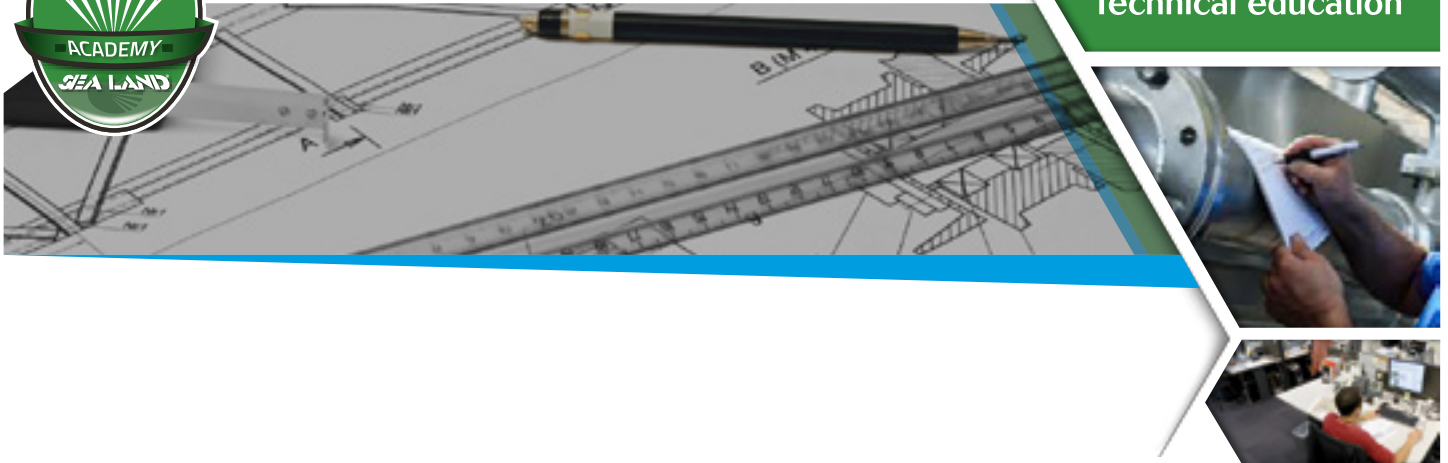

- Almost total chemical inertness, though this can be reduced by having to add a filler, e.g. glass fiber, to improve its mechanical properties.

DISADVANTAGES:

- PTFE has a low strength and deforms easily under load. This can be improved by compounding with chopped glass fiber, but even so it has relatively poor properties compared to carbon grades. Its use is thus confined to few low-duty applications;
- Despite its self-lubricating properties, PTFE does not perform well under boundary friction conditions; high heat generation can cause severe deformation and lead to rapid failure;
- Not suitable for applications involving abrasive liquids;
- Low thermal conductivity.

GRADES IN USE

PTFE can be used virgin or filled to improve its mechanical properties. Common PTFE fillers are glass fibers and graphite.

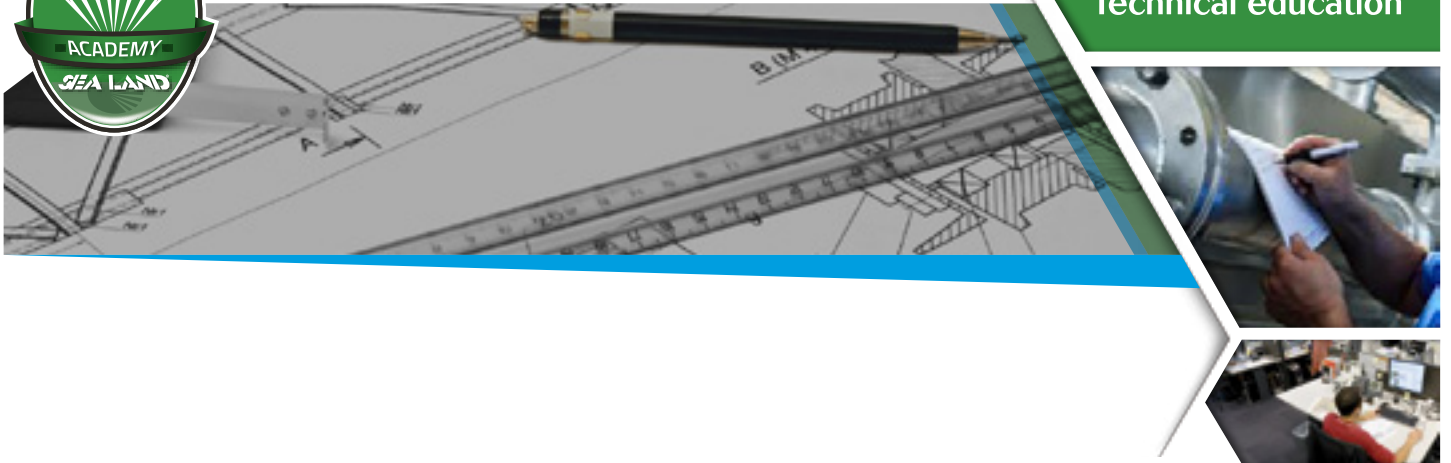

COUNTERFACES

PTFE is usually run against high purity aluminum oxide (99,5% Al_2O_3), giving a combination that is highly resistant to a wide range of chemicals, including those that attack carbon, but limited in application because of the low thermal conductivity of both faces.

3.3 ALUMINIUM OXIDE

Alumina (aluminum oxide) ceramics were the first hard non-metallic materials to be used as mechanical seal faces.

ADVANTAGES:

- A cheap hard material, very cost effective in large volume. Good wear resistance;
- Very good chemical resistance, depending on the grade used;
- Very good running properties of water and aqueous solutions using a carbon counterface. Can withstand mildly abrasive solutions.

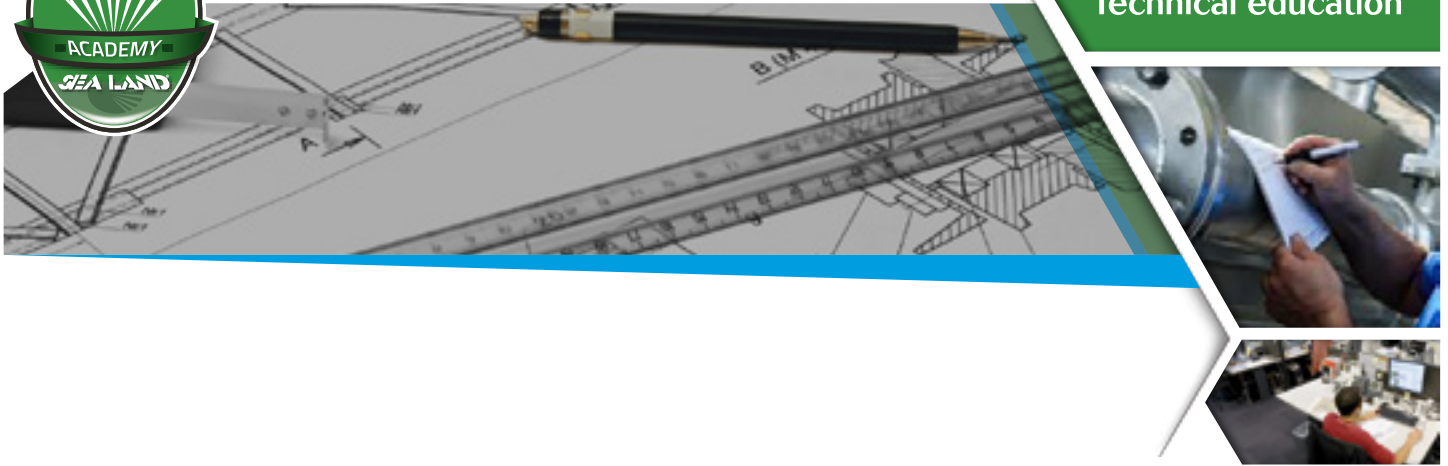

DISADVANTAGES:

- Poor thermal conductivity, causing poor heat dissipation in critical applications. Therefore, alumina is used in applications which are not particularly severe;
- Poor thermal shock resistance; this can cause problems during transient conditions. Poor dry running characteristics;
- A brittle material.

GRADES IN USE

Aluminium oxide ceramic is available in several different grades defined by the aluminum oxide (Al_2O_3) content. The remaining impurities are usually glass or silica type impurities which can be attacked by certain chemicals, e.g. hydrofluoric acid, strong alkalis.

The preferred grade for maximum chemical resistance is 99.7% Al_2O_3 . Thermal conductivity and hardness increase with increasing Al_2O_3 content.

COUNTERFACES

Alumina is run against resin impregnated carbon-graphite or filled PTFE,

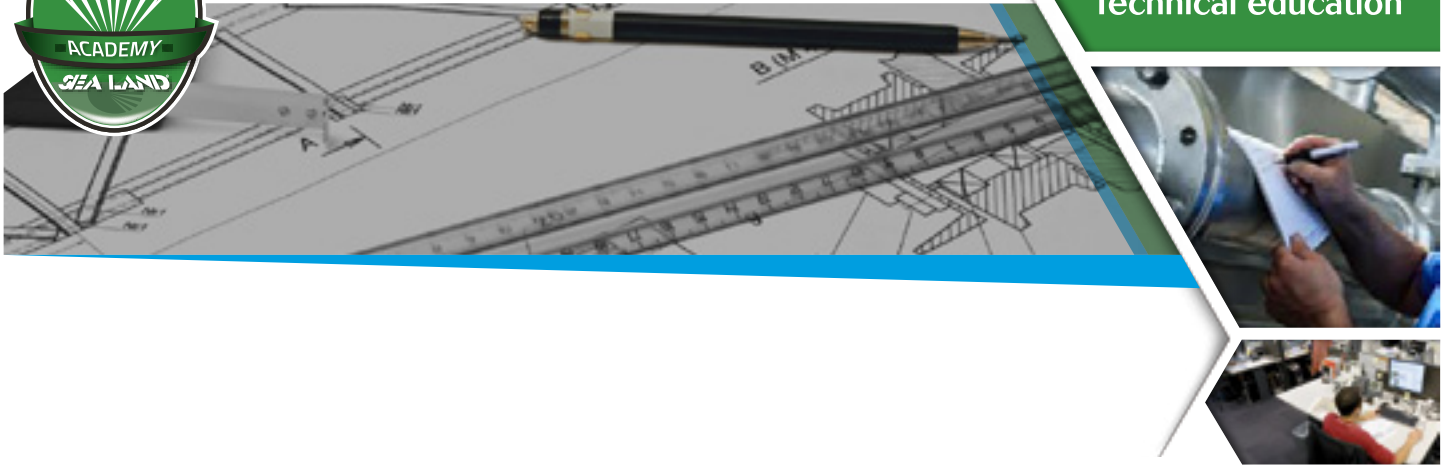

the latter being used for highly corrosive chemical conditions.

3.4 STEATITE

The term “steatite”, or more colloquially “ceramic” is used for a ceramic composite based on magnesium silicate.

In water applications, for low duties, Steatite is the ideal choice for one of the seal faces, when is required a highly cost-effective in large volume.

Compared to aluminum oxide, steatite has lower hardness and chemical resistance.

ADVANTAGES:

- A very cheap hard material, high cost-effective in large volume;
- Good hardness characteristic;
- Good running properties of water and aqueous solutions using a carbon counter-face.

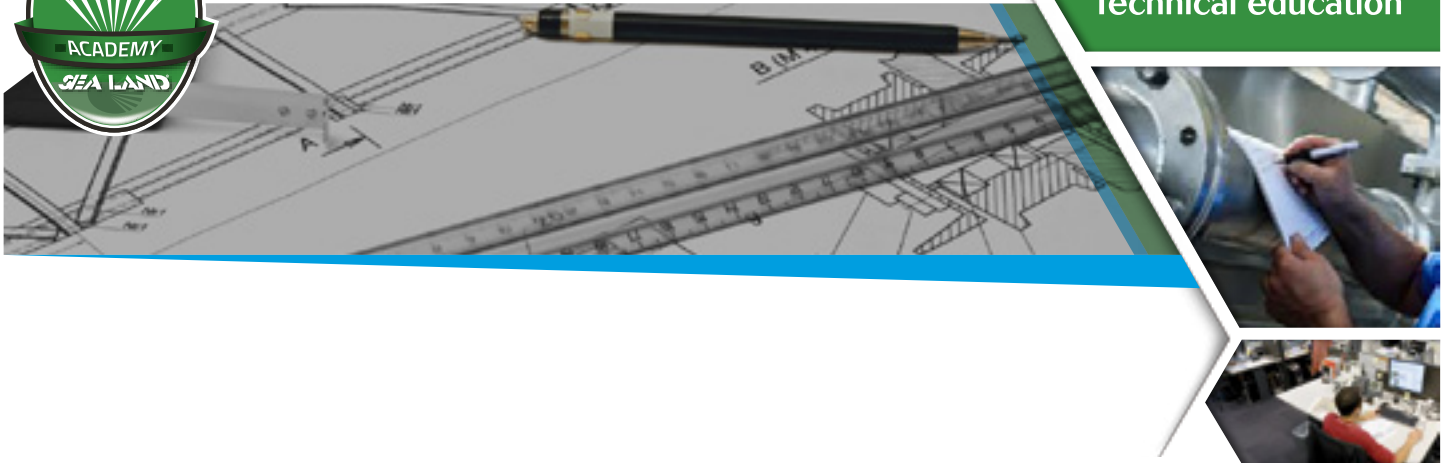

DISADVANTAGES:

- Low chemical resistance.
- For low duty applications.
- Very low thermal conductivity, giving poor heat dissipation in critical applications.
- Poor thermal shock resistance; this can cause problems during transient conditions. Very poor dry running capability.
- A brittle material that is susceptible to mechanical damage.

COUNTERFACES

Steatite is generally run against resin impregnated carbon-graphite, for low-duty applications in water and aqueous solutions.

3.5 CEMENTED CARBIDES (HARD METALS – TUNGSTEN CARBIDE)

Cemented tungsten carbide consists of hard carbide particles bonded together by a ductile metal. Traditionally it has been used on more severe duties (e.g. fluid containing abrasive particles) thanks to its su-

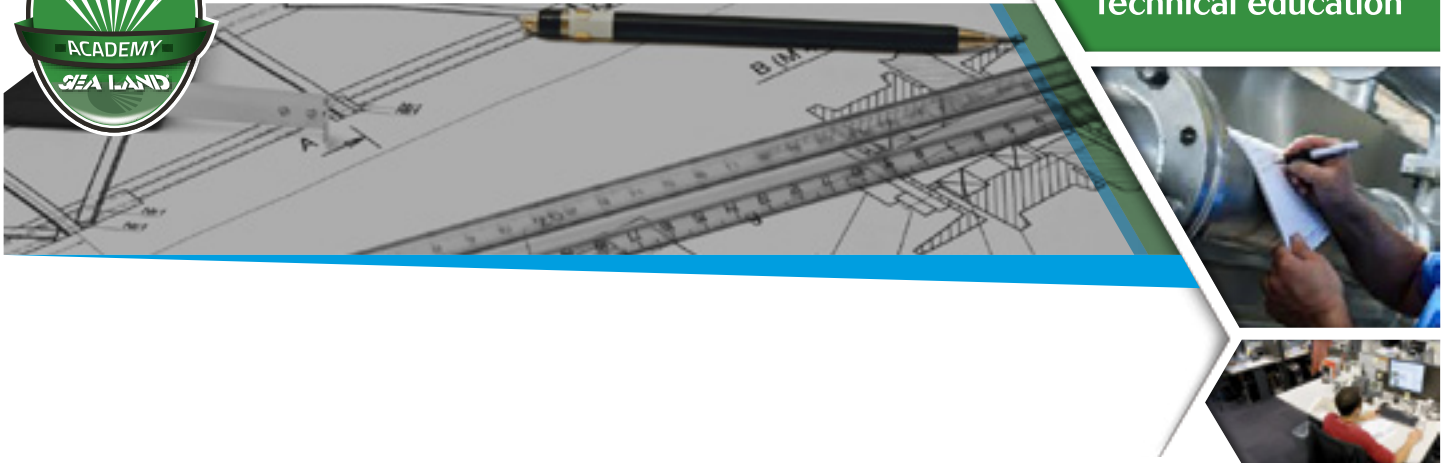

perior wear resistance, mainly due to its high toughness. While more expensive than the materials already discussed, it is now being increasingly used on less severe duties because of the improvement in seal life.

ADVANTAGES:

- Good wear properties with more severe duties;
- High thermal conductivity;
- High elastic modulus, hence less sensitive to pressure distortion than metallic face materials;
- Better resistance to mechanical shock compared with other hard non-metallic materials.

DISADVANTAGES:

- Limited chemical resistance, particularly on acid duties;
- Very high density; this can be critical in high-speed rotating applications;
- Limited ability to work with dry running conditions or boundary lubrication conditions when running against itself. In case of dry run-



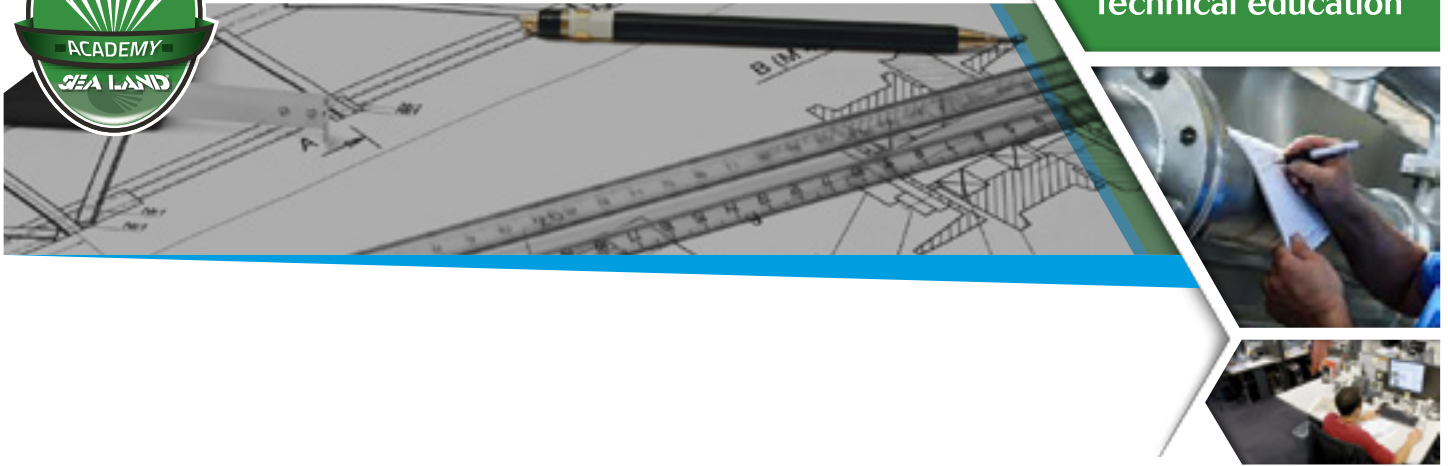

- ning, the temperature increases to several hundred degrees Celsius in few seconds, damaging the seal faces and the near rubber parts;
- High raw material cost.

GRADES IN USE

Cobalt and nickel bonded tungsten carbides are most commonly used for mechanical seal faces.

The binder phase provides toughness and tensile strength, and it is the binder that dictates the chemical resistance.

Tungsten carbide grades are poor in acid media; cobalt grades being restricted to pH values above 7.

Nickel binder grades have improved chemical resistance particularly on water and aqueous solutions, but are still restricted to pH values above 6.

Special binder grades that are resistant to pH values as low as 2 are available, but those are relatively expensive.

COUNTERFACES

Tungsten carbide is usually run against resin impregnated carbon-

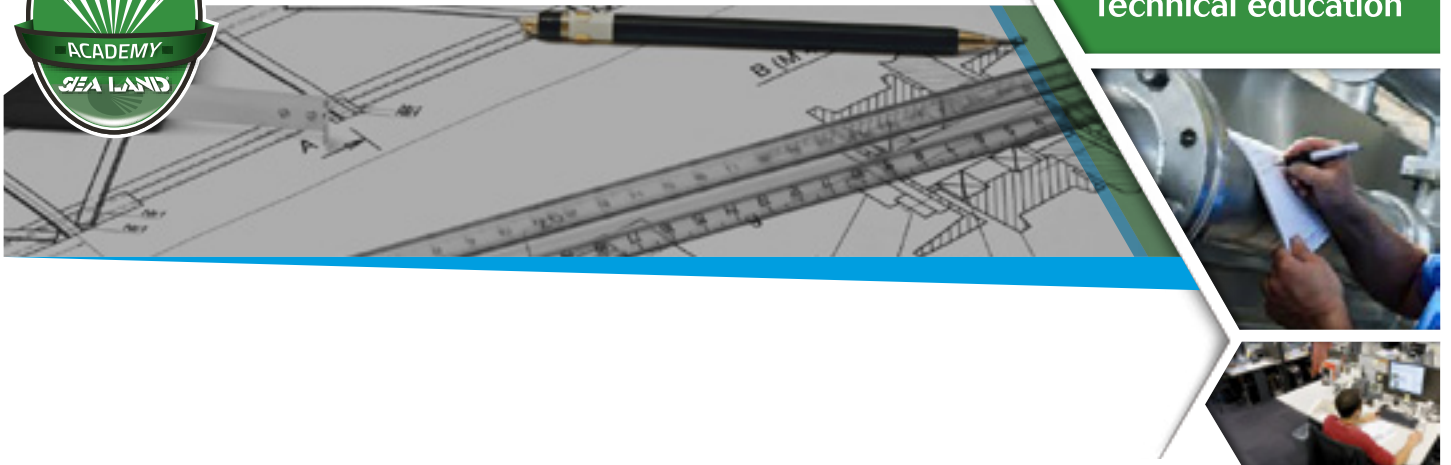

graphite or metal impregnated carbon grades.

When running against carbon, tungsten carbide is a good counter face and less susceptible to thermal shock than aluminum oxide. This combination is good for transient conditions and under conditions of boundary lubrication. In abrasive media, tungsten carbide can be run against itself or silicon carbide. In this case, tolerance to dry running and lubricating boundary conditions is poor.

3.6 SILICON CARBIDE

Silicon carbide is increasingly used, not only in high duty applications, but even on lower duties as the benefits outweigh the higher initial cost.

ADVANTAGES:

- Good wear resistant and frictional properties on severe duties;
- High thermal conductivity, better than tungsten carbide;
- Good thermal shock resistance;



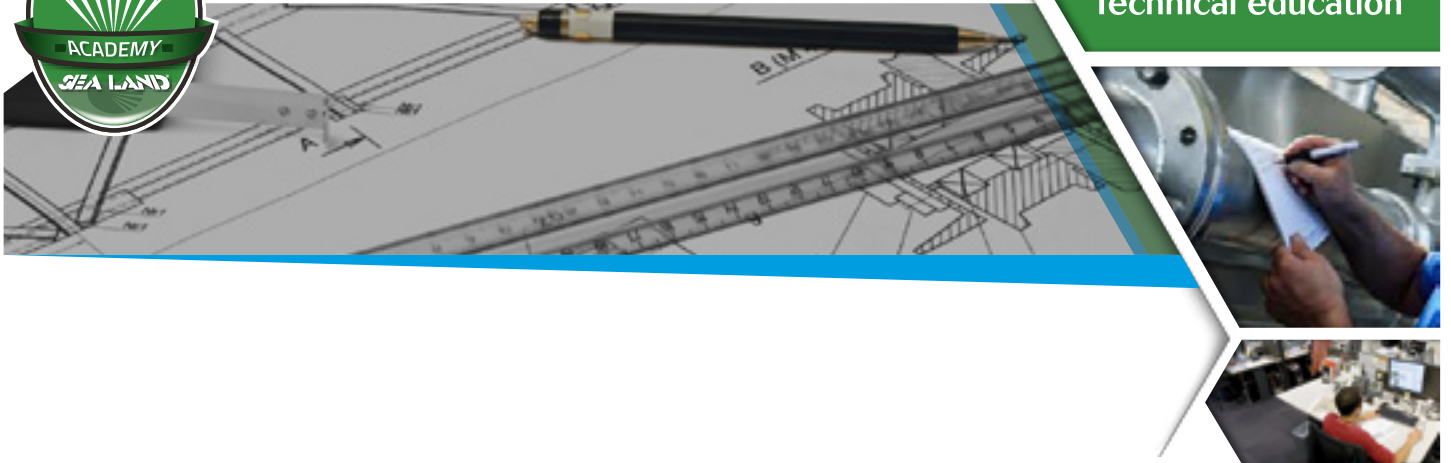

- High elastic modulus;
- Excellent chemical resistance;
- Lower density than tungsten carbide;
- Lower price than tungsten carbide
- Raw material readily available.

DISADVANTAGES:

- Lower toughness, depending on the grade, than tungsten carbide; can be easily damaged mechanically;
- The low flexural strength which, to some extent, offsets the density advantage over tungsten carbide;
- Certain grades are corroded by strong alkalis.

GRADES IN USE

Care should be taken in selecting silicon carbide; the differences in properties between the grades from different suppliers are greater than with respective tungsten carbide grades.

There are several families of silicon carbide. Here only the ones typically used as seal face material are reported:

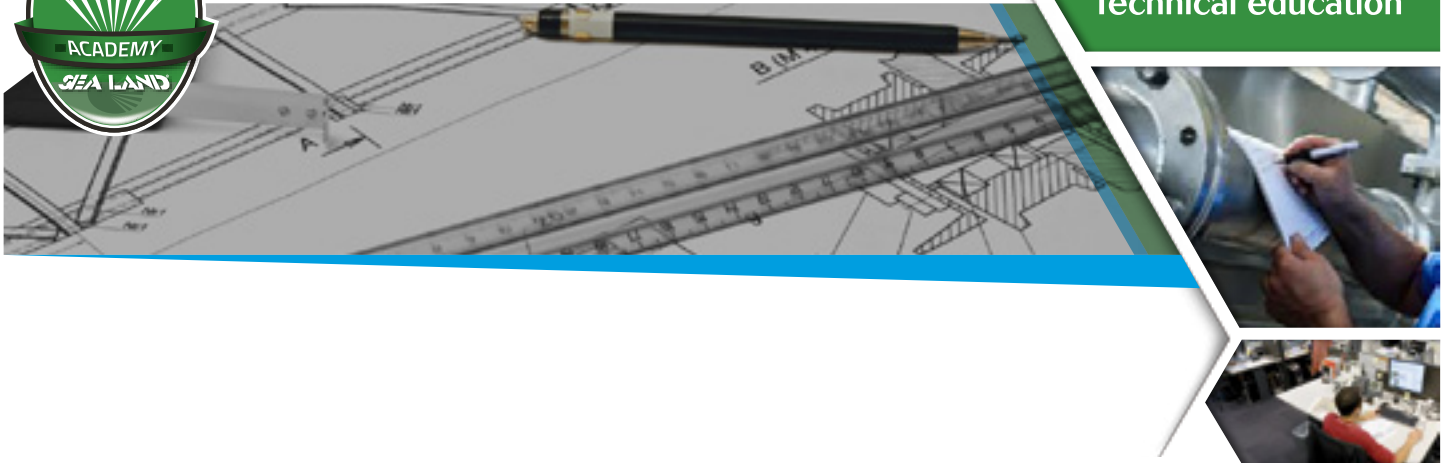

Sintered alpha, SiC - These grades contain no free silicon. They have the best chemical and wear resistance, but lowest flexural strength. The friction characteristics are more inferior than reaction bonded grades, but superior to tungsten carbide.

Reaction bonded, SiC-Si - These grades contain free silicon and have the best friction characteristics of all super hard seal face materials. Some acid or alkaline media can cause leaching of the free silicon, but they are more inert than tungsten carbide.

Silicon carbide / graphite composite, SiC-C - This is a relatively new material and consists of a matrix of silicon carbide and graphite. The purpose of these composites is to combine the high wear resistance of silicon carbide with the lubricating qualities of carbon graphite, especially to improve the service life in applications with high friction.

COUNTERFACES

Silicon carbide against carbon is a frequently used combination for long life in a wide variety of conditions, because of its excellent resistance to thermal shock, transient, and boundary conditions.

In abrasive applications silicon carbide usually is run against tungsten carbide, giving the most effective combination for wear resistance and friction.

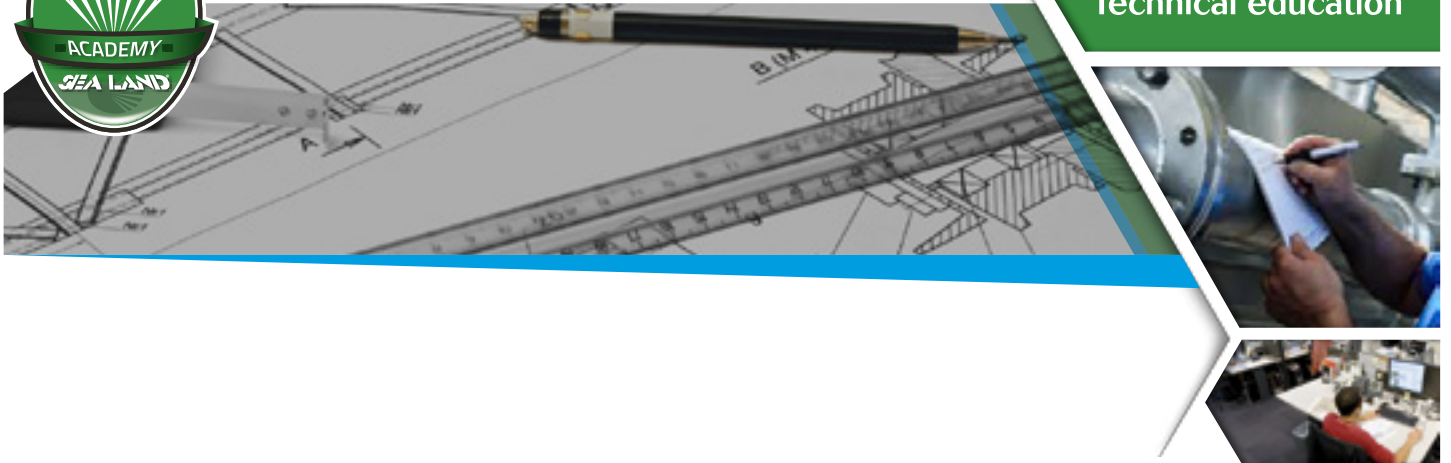

The combination of silicon carbide against tungsten carbide has been used successfully on high duty applications where carbon causes problems because of high distortion and wear.

Silicon carbide can be run against itself for extremely abrasive conditions, but frictional characteristics are not as good as silicon carbide versus tungsten carbide.

Generally, as with all hard face combinations, boundary conditions can result in surface thermal shock and care has to be taken to avoid even transient dry running. However, the silicon carbide graphite composites (SiC-C) material withstands a limited period of dry running because of the graphite content in the material.

3.7 OTHER MATERIALS

Since the seal faces are vital to the functioning of the mechanical seals, new materials are constantly evaluated.

When the cost is an important factor and the range of applications not requiring a special material quality, also materials such as steel or cast iron (Ni-resist) can be used.

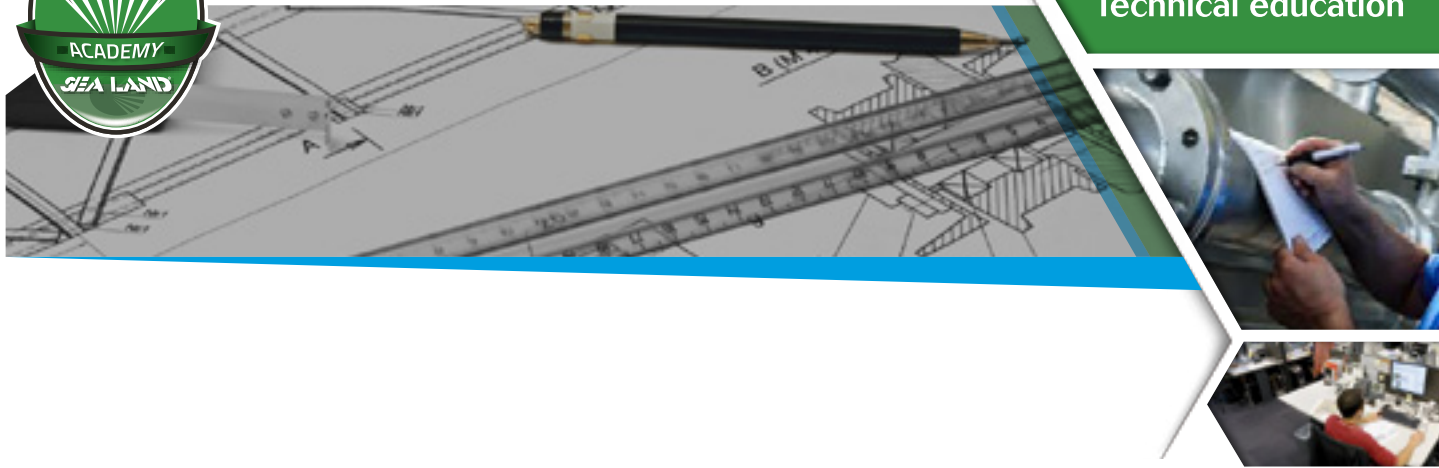

3.8 MATERIALS PROPERTIES

The following tables show the main physicochemical and mechanical properties of materials commonly used for sealing ring.

Table 1 - Typical physical and mechanical properties of commonly used face materials

| | density (kg/m ³) | Youngs modulus (GN/m ²) | Bending strength (MN/m ²) | Tensile strength (MN/m ²) | Thermal conductivity (W/mK) | Hardness (Vickers, if not stated) | Thermal expansion coefficient (K ⁻¹ x 10 ⁻⁶) | Thermal shock parameter (W/m) |
|-------------------------------------------|---------------------------------|-------------------------------------------|---------------------------------------------|---------------------------------------------|-----------------------------------|-----------------------------------------|------------------------------------------------------------------------------|----------------------------------------|
| Carbon graphite resin impregnated | 1800 | 23 | 65 | 41 | 11.0 | 90-100 Shore A | 3.0 | 10360 |
| Carbon graphite antimony filled | 2500 | 33 | 90 | 48 | 13.5 | 85-95 Shore A | 3.5 | 10520 |
| PTFE 25% glass | 2250 | - | - | 12-20 | 0.4 | 70-75 Shore D | 44-92 | - |
| Ni-resist | 7300 | 96 | - | 200 | 40.0 | 150 | 19.0 | - |
| Martensitic steal (AISI 431) | 7720 | 210 | - | 850-1000 | 18.8 | 261-319 | 11.1 | - |
| Aluminium oxide 99,5% | 3870 | 365 | 480 | 120 | 30.0 | 2500 | 6.9 | 5718 |
| Tungsten carbide (Co binder) | 14700 | 630 | 1750 | 900-1700 | 88.0 | 1500-1600 | 5.1 | 47930 |
| Tungsten carbide (Ni binder) | 14700 | 600 | 1700 | 1450-1550 | 73.0 | 1300-1500 | 4.8 | 43090 |
| Silicon carbide (reaction bonded) | 3100 | 413 | 525 | 310 | 100-150 | 2500 | 4.3 | 59120 |
| Silicon carbide SiC (sintered) | 3100 | 390 | 450 | - | 130 | 2500-3500 | 4.8 | 24040 |
| Silicon carbide with graphite SiC-C | 2800 | 152 | 131 | - | 110 | 2500 | 3.4 | 38780 |

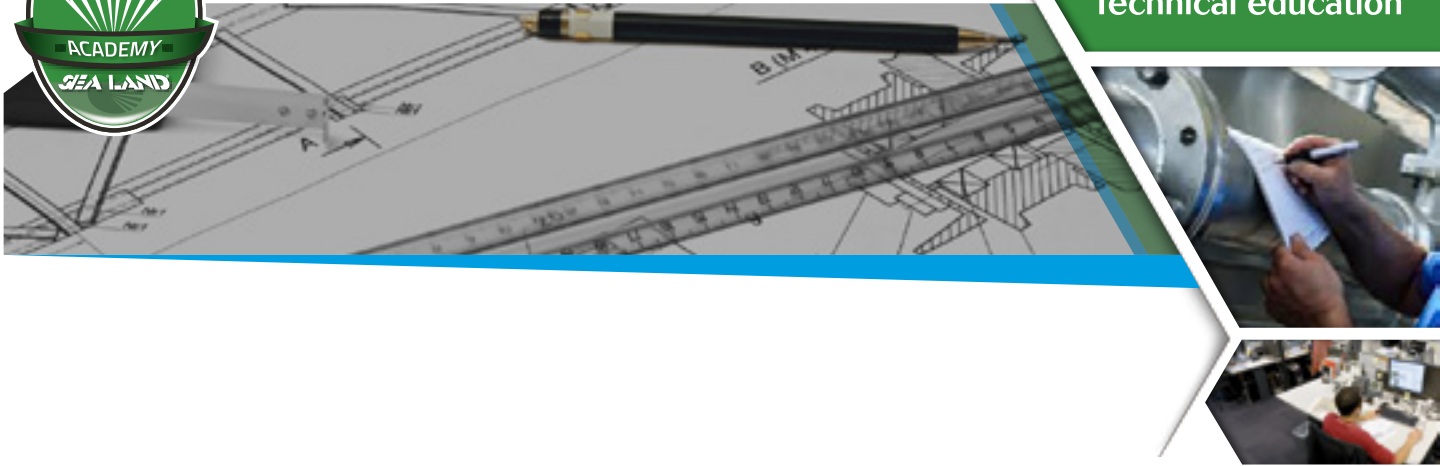

Table 2 – Strengths, weaknesses and chemical compatibility of commonly used face materials

| | General duty | Use with abrasives | Blister resistance | Thermal shock resistance | Light hydrocarbons | Heavy hydrocarbons/oil | Acids | Bases | Chemical resistance |
|-----------------------------------|--------------|--------------------|--------------------|--------------------------|--------------------|------------------------|-------|-------|---------------------|
| Carbon graphite resin impregnated | 4 | 1 | 2 | 4 | 2 | 3 | 3 | 3 | 3 |
| Carbon graphite Sb-impregnated | 2 | 1 | 4 | 4 | 4 | 3 | 1 | 1 | 2 |
| Aluminum oxide 99,5% | 2 | 2 | 2 | 1 | 4 | 4 | 4 | 4 | 4 |
| Turgsten carbide | 3 | 4 | 2 | 3 | 4 | 4 | 3 | 3 | 3 |
| Silicon carbide (reaction bonded) | 4 | 4 | 4 | 4 | 4 | 4 | 2 | 1 | 3 |
| Silicon carbide (sintered) | 4 | 4 | 4 | 4 | 4 | 4 | 4 | 4 | 4 |

1 = poor; 2 = fair; 3 = good; 4 = excellent

3.9 “PV” FACTOR

The factor “PV” is commonly used to express the severity of the contact conditions between the sliding surfaces, to identify the operational limits and ensure a long seal life.

“P” is commonly expressed the differential pressure [bar], while “V” is the sliding velocity refers to the mean diameter, expressed in [m/s]. The PV factor is a way to obtain an approximate assessment of the materials and seals performance.

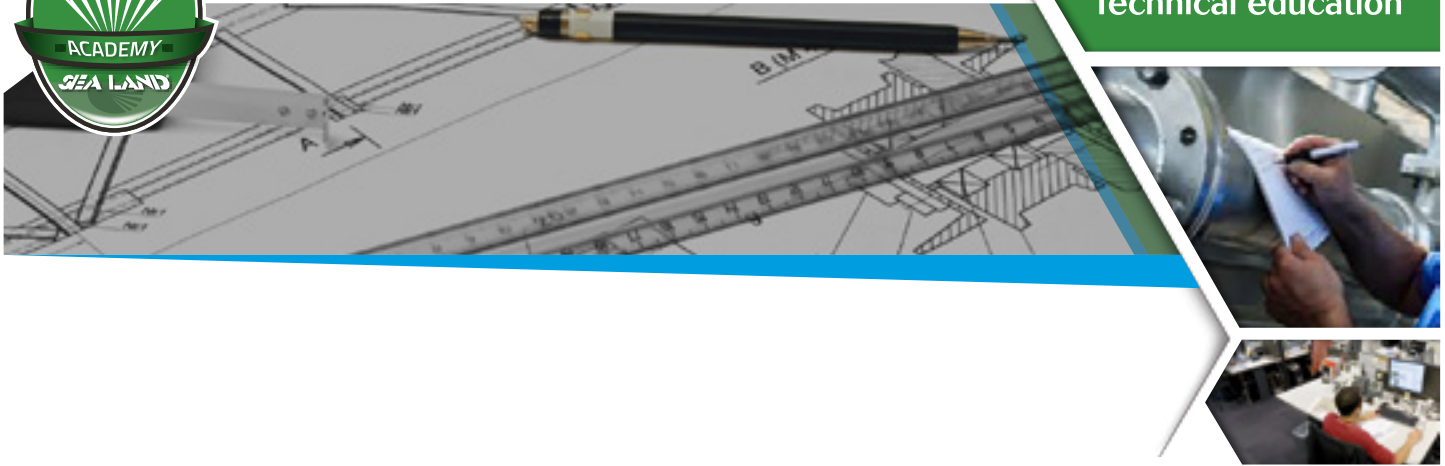

The higher the value of PV, stronger operating conditions the material combination can support.

This parameter is not only influenced by the type of materials in contact and by the fluid whose sealing action must be ensured, but the PV is strongly affected also by the change in the design of the components (the seal can be balanced or unbalanced).

The PV value does not take into consideration any other factors such as misalignment, vibration, temperature and viscosity of the liquid, the presence of abrasive solids in the fluid and the system operating conditions (e.g. some starts & stops).

For a mechanical seal it's possible to calculate the PV factor using the following formula:

$$PV = P \cdot (d_i + d_e) \cdot N / 38.200 \quad [\text{bar} \cdot \text{m/s}]$$

Where P [bar] is the differential pressure, "di" [mm] is the internal diameter of the sliding face, "de" [mm] is the external diameter of the sliding face and N is the number of rotations N [rpm] completed by the shaft.

In the following table are shown the approximate PV limits in [bar*m/s] for generic mechanical seals, with variations in the combination of se-

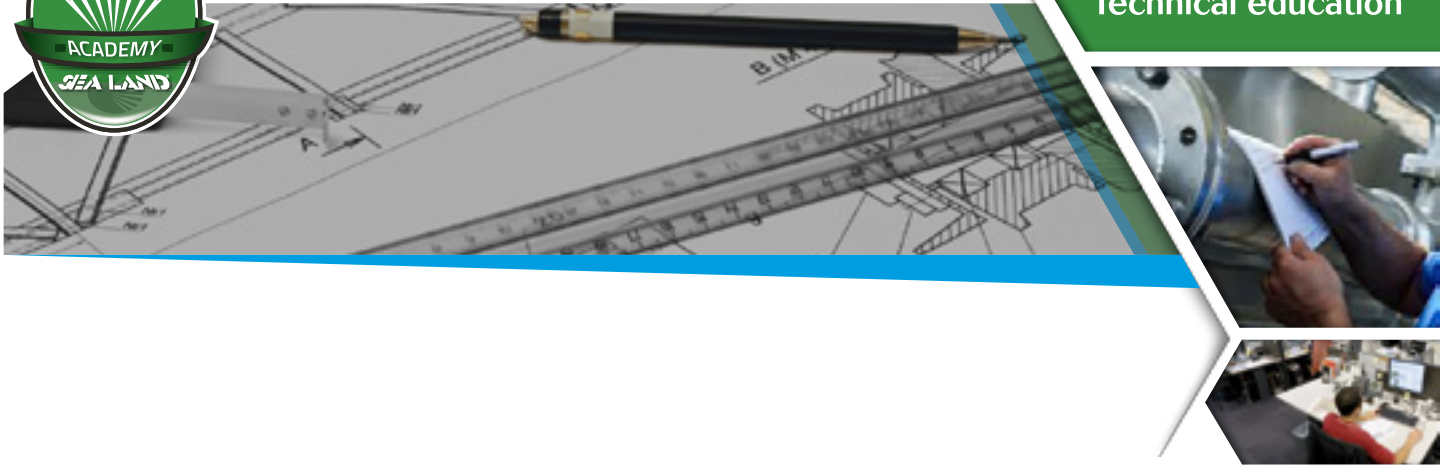

veral materials and fluid types.

Table 3 – Approximate PV limit values for generic mechanical seals for several material combinations and fluid types.

| Materials combination | Water and water solutions | | Other liquids | |
|-----------------------------------|---------------------------|----------|---------------|----------|
| | Unbalanced | Balanced | Unbalanced | Balanced |
| Carbon vs. | | | | |
| Stainless steel | 5 | - | 30 | - |
| Cast iron (Ni-resist) | 23 | 85 | 52 | 580 |
| Alumina oxide | 35 | 210 | 90 | 420 |
| Tungsten carbide | 70 | 420 | 90 | 1220 |
| Silicon carbide | 90 | 630 | 90 | 1850 |
| Silicon carbide vs. | | | | |
| Silicon carbide | 50 | 300 | 80 | 850 |
| Tungsten carbide | 60 | 360 | 90 | 1050 |
| Silicon carbide with graphite vs. | | | | |
| Silicon carbide | 70 | 420 | 88 | 1225 |
| Tungsten carbide | 70 | 420 | 88 | 1225 |
| Tungsten carbide vs. | | | | |
| Tungsten carbide | 45 | 260 | 70 | 420 |



4. SECONDARY SEAL MATERIALS (**)

The term “secondary seal components”, or more easily “secondary seals” is used for the components like o-ring, bellows or gasket.

Typically these items are commonly made of elastomeric materials, but not all.

In the following section are indicated the materials commonly used, with the main properties and characteristics.

4.1 ELASTOMERS

Nitrile Butadiene Rubber – NBR, e.g. Perbunan®

The properties of the Nitrile Rubber depend mainly on the ACN content which ranges between 18% and 50%. NBR can be used with temperatures between -30 °C and +100 °C, but with mechanical seals an operating temperature between -20 °C e +80 °C is recommended (for a short period also up to +90 °C). NBR is mostly used with mineral based oils and greases.

(**) The characteristics and properties of the materials presented are approximate, may vary depending on the formulation of raw material.

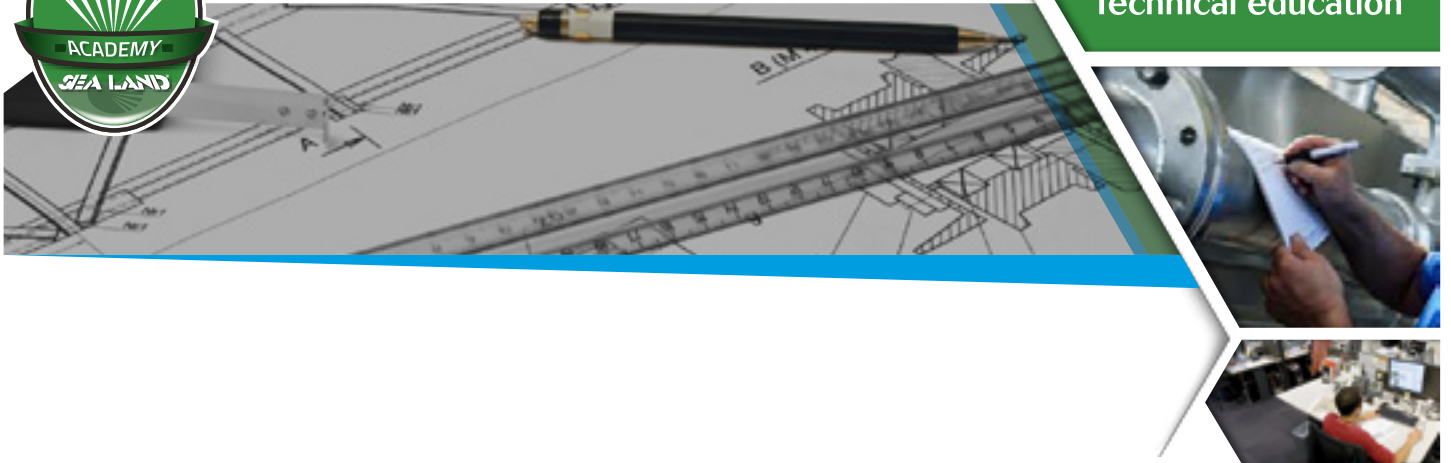

Fluorocarbon Rubber – FKM, e.g. Viton®

Depending on the structure and fluorine content FKM materials can differ with regards to their chemical resistance and cold-flexibility.

FKM is known especially for its non-flammability, low gas permeability and excellent resistance to ozone, weathering, and aging.

The operating temperatures of the Fluorocarbon Rubber range between $-20\text{ }^{\circ}\text{C}$ and $+200\text{ }^{\circ}\text{C}$ (for a short period up to $+220\text{ }^{\circ}\text{C}$). FKM is generally used with oils and other nonpolar chemicals at high temperature, on the contrary, its resistance to hot water and other polar chemicals is lower and therefore other elastomers are preferred.

Ethylene Propylene Diene Rubber – EPDM, e.g. Nordel®

EPDM shows good heat, ozone, and aging resistance. Also, it also exhibits high levels of elasticity, excellent low-temperature behavior as well as good insulating properties.

The operating temperatures of applications for EPDM range between $-40\text{ }^{\circ}\text{C}$ and $+125\text{ }^{\circ}\text{C}$ (for a short period up to $+140\text{ }^{\circ}\text{C}$).

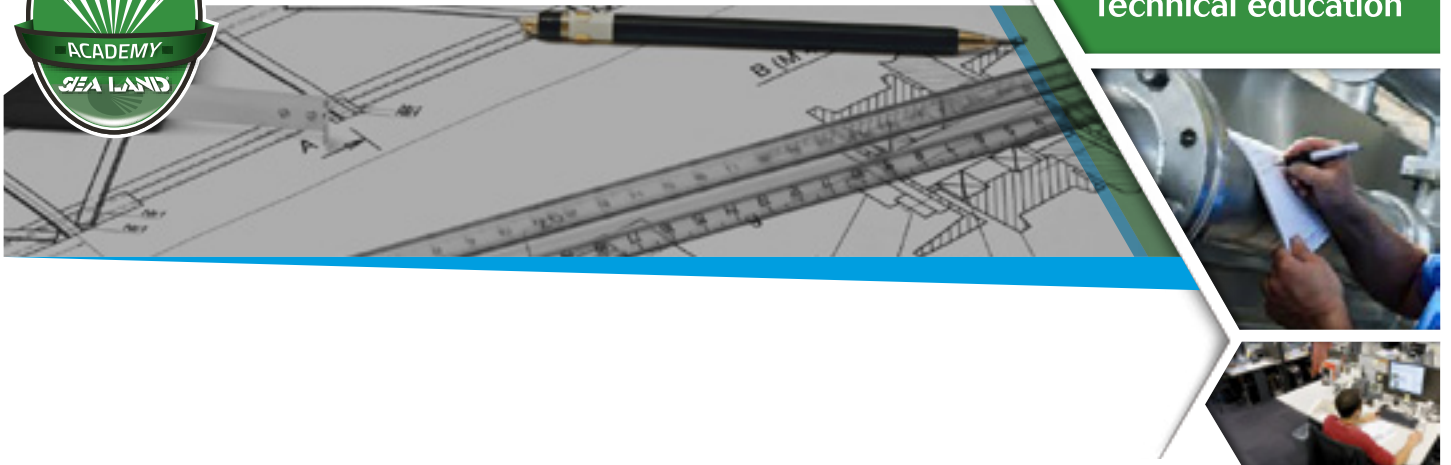

With sulphur cured types the range is reduced to -40°C and $+110^{\circ}\text{C}$. EPDM can often be found in applications with brake fluids (based on glycol) and hot water. EPDM has a high resistance to water and other polar chemicals, but is easily damaged by oils and other nonpolar chemicals, as opposed to NBR and FKM which perform better with oils as with water.

Hydrogenated Nitrile Butadiene Rubber – HNBR, e.g. Therban[®]

HNBR is made via selective hydrogenation of the NBR butadiene groups. Compared to NBR, HNBR can withstand higher temperatures. The operating temperature of HNBR ranges between -30°C and $+130^{\circ}\text{C}$ (for a short period up to $+150^{\circ}\text{C}$). HNBR can be used with water, water-glycol and in contact with mineral oils and greases.

Silicone rubber – VMQ (MQV)

The silicone rubber shows excellent properties of heat resistance, cold flexibility, and dielectric properties.





Silicone has good resistance, particularly against oxygen and ozone. Depending on the material, the operating temperatures ranges are from -50 °C to +200 °C (for a short period up to 230 °C). Silicone rubber is typically used in the medical and food industries. Unfortunately, the mechanical properties are poor, so that the silicone rubber tends to be used in mechanical seals only in some specific applications (e.g. static seals).

Table 4 – Elastomers (o-ring), main characteristic

Below are the approx. operating temperature ranges of elastomeric o-rings.

| Pumped medium | Elastomer | | | | | |
|------------------------------|-----------|------|-----|-----|-----|-----|
| | NBR | HNBR | NBR | NBR | NBR | NBR |
| Water, max. temp. [°C] | 80 | 100 | 120 | 140 | 90 | 230 |
| Mineral oils, max. temp.[°C] | 100 | 150 | 120 | -- | 200 | 230 |
| Acids | +/- | + | +/- | +/- | +/- | + |
| Alkalis | + | + | +/- | + | -- | + |
| Glycols | + | + | + | + | -- | + |
| Oils, fuel | +/- | +/- | +/- | -- | + | + |
| Solvents | -- | -- | -- | -- | +/- | + |
| Abrasive particles | +/- | + | - | + | +/- | - |

Legend:
 + = excellent
 +/- = good under certain conditions
 - = poor
 -- = not suitable

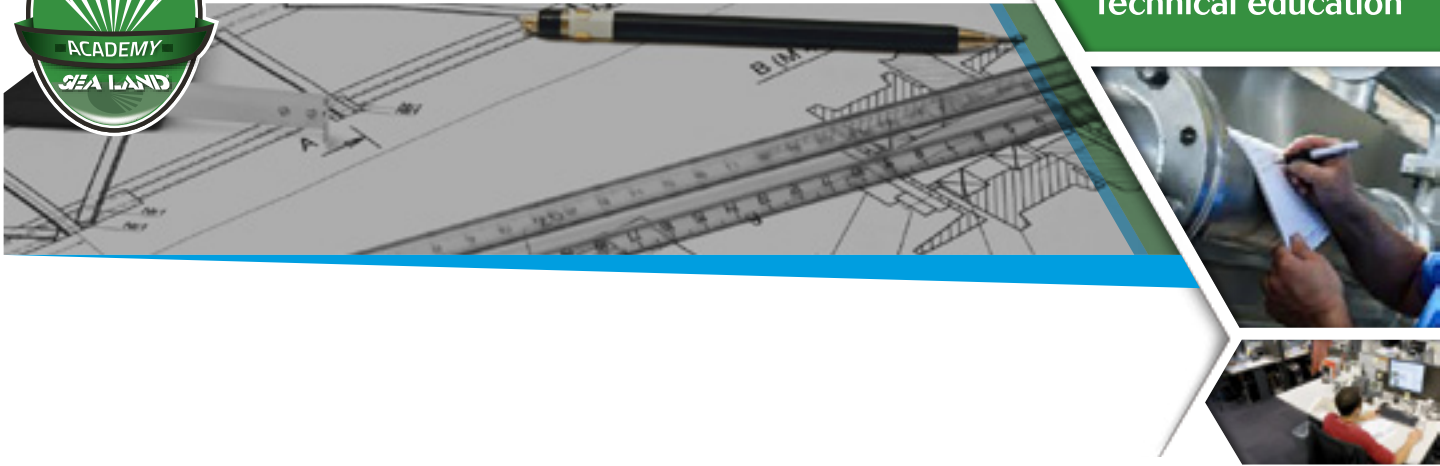

| | 0C/32F | | |
|-------------|--------------------------------------|-----------------------------------------------------------|----------------------|
| -30C/-20F | Nitril Butadien Rubber Perbunan* | +100C/212F | } Static O-rings |
| -40C/-40F | Ethylen Propylen Dien Rubber EPDM | +150C/302F (never use with any oil) +140C/284F (water) | |
| -20C/-4F | Fluor Carbon Rubber Viton* | +200C/392F +75C/167F (water) | |
| Temperature | | | |
| -20C/-4F | Nitril Butadien Rubber Perbunan* | +75C/167F | } Dinamic O-rings |
| -20C/-4F | Ethylen Propylen Dien Rubber EPDM | (never use with any oil) +140C/284F (water) | |
| -5C/-23F | Fluor Carbon Rubber Viton* | +150C/302F (oil) +75C/167F (water) | |
| Temperature | | | |

Perfluoro Rubber – FFKM, e.g. Kalrez[®], Chemraz[®], Simriz[®]

Perfluoroelastomers show broad chemical resistance similar to PTFE as



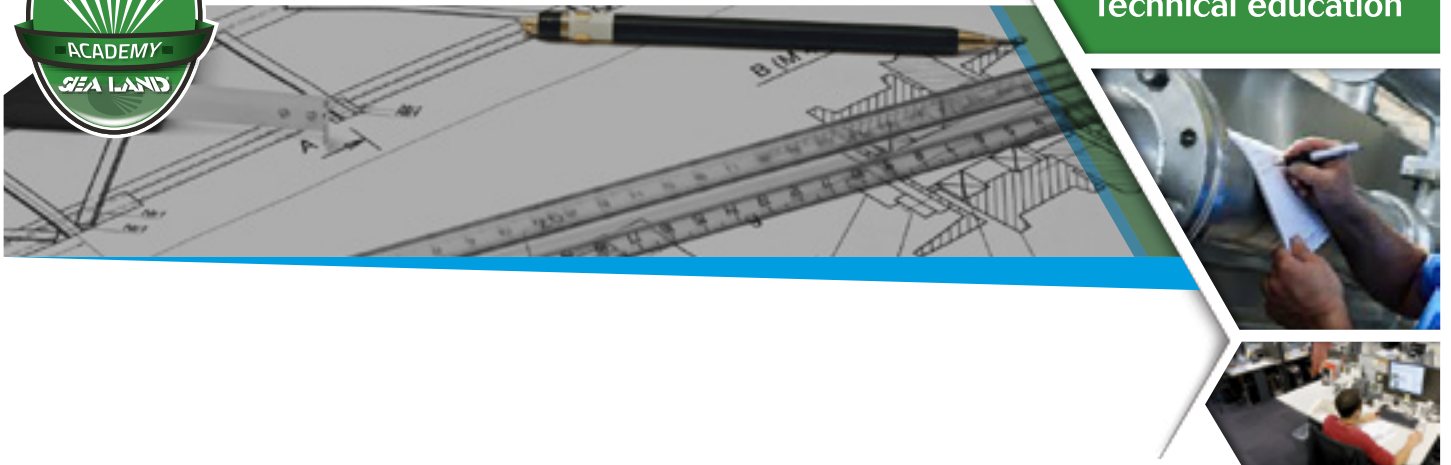

well as excellent heat resistance.

They show low swelling with almost all media. Depending on the material grade, the operating temperatures range is between $-15\text{ }^{\circ}\text{C}$ and $+240\text{ }^{\circ}\text{C}$. Special types can be used up to $+325\text{ }^{\circ}\text{C}$.

Applications for FFKM can be mostly found in the chemical and process industries and in all applications with either aggressive environments or high temperatures.

4.2 WRAPPED ELASTOMERS

This solution (the wrapping) is mainly used in the o-rings to improve the chemical and thermal resistance of the standard elastomers materials.

TTV, TTE and TTS o-ring

The core of the o-ring is made with “basic” materials, like EPDM rubber, fluorocarbon rubber FKM or silicon rubber VMQ, outside the o-ring is wrapped with PTFE, like a “case”.

The material PTFE features an excellent chemical and thermal resistance, but it also displays a high degree of rigidity, a low coefficient of ther-



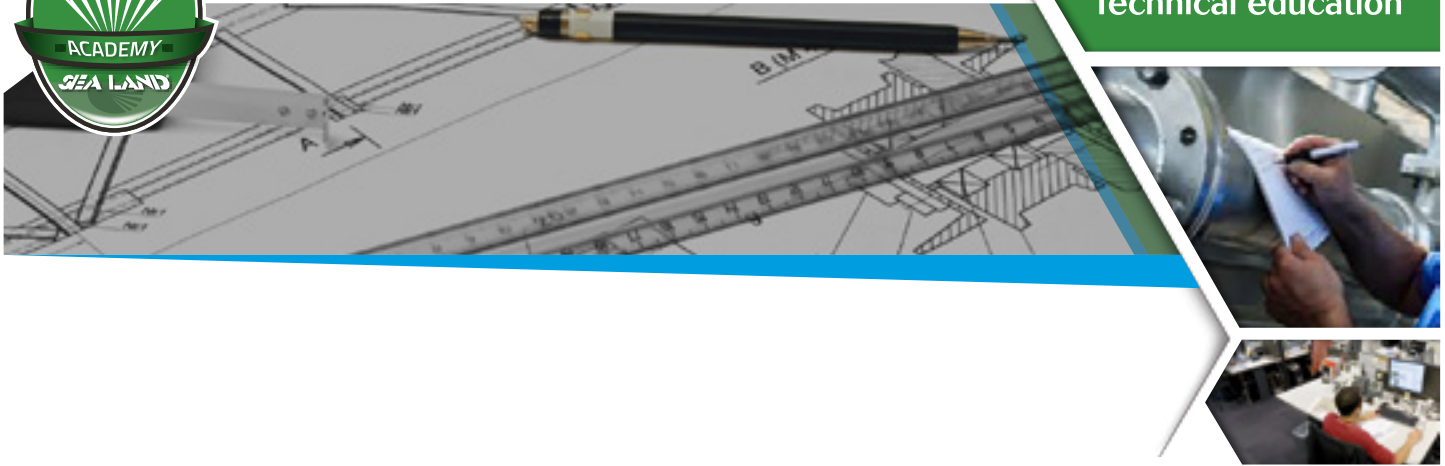

mal conductivity and unfavorable expansion characteristics.

Based on the elastomers material in the o-ring core, is possible to have:

TTV o-ring (fluorocarbon rubber FKM, double PTFE wrapped)

TTE o-ring (EPDM rubber, double PTFE wrapped)

TTS o-ring (silicone rubber VMQ, double PTFE wrapped)

Applications for wrapped o-ring can be mostly found in the chemical industries and in applications with either aggressive environments or high temperatures.

FEP / PFA o-ring

FEP / PFA o-ring are made of an elastic core in fluorocarbon elastomer (FKM) or silicone (VMQ) wrapped in a sheath of chemically inert FEP (fluorinated ethylene-propylene) or PFA (perfluoroalkoxy alkane).

This technique allows the o-ring to combine the elasticity of a standard o-ring (the risk of tearing of the sheath has to be taken into account) to the smoothness, temperature and chemical resistance of FEP and PFA, which are similar to PTFE.

Compared to TTV and TTE o-ring described previously, the external sheathing is continuous (without interruption).

To increase the deformability and elasticity, o-rings can be produced

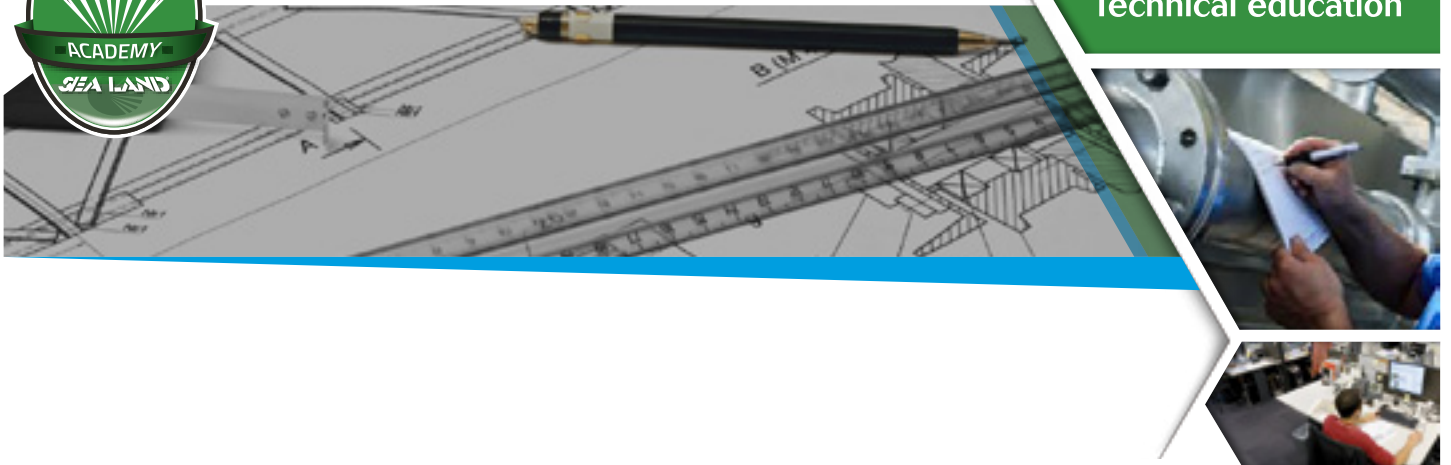

using a silicone tube inside the FEP / PFA sheath.

The PFA has an appearance and properties very similar to the FEP.

PFA, however, reaches operating temperatures up to +260 °C (against the +200 °C of FEP) and ensures a better resistance to gases.

The o-rings in FEP and PFA are resistant to chemical aggression (except molten alkali metals, fluorine and some halogenated compounds at high temperatures).

These o-rings are commonly used in applications involving aggressive chemicals or high temperature, where the normal o-rings are not suitable.

ELASTOMERS: GENERAL COMMENTS AND CERTIFICATES

NBR

The properties of Nitrile Rubber depend mainly on the ACN content which ranges between 18% and 50%. In general they show good mechanical properties.

The operating temperatures ranges in water between -15°C and +80°C. NBR is mostly used with mineral based oils and greases.





EPDM

EPDM shows good heat, ozone and aging resistance. In addition they also exhibit high levels of elasticity, good low temperature behaviour as well as good insulating properties.

The operating temperatures of applications for EPDM range in water between -40°C and $+120^{\circ}\text{C}$ (with peroxide cured type; less with Sulphur cured types). EPDM can often be found in applications with based glycol fluids and hot water (never use with any mineral oils or fats).

HNBR

HNBR is made via selective hydrogenation of the NBR butadiene groups. The properties of HNBR rubber depend on the ACN content which ranges between 18% and 50% as well as on the degree of saturation. HNBR shows better mechanical properties compared to standard NBR. The temperature range in water of HNBR rubber is: -20°C and $+110^{\circ}\text{C}$.

FKM

Depending on the structure and fluorine content FKM materials can differ with regards to their chemical resistance and cold-flexibility.



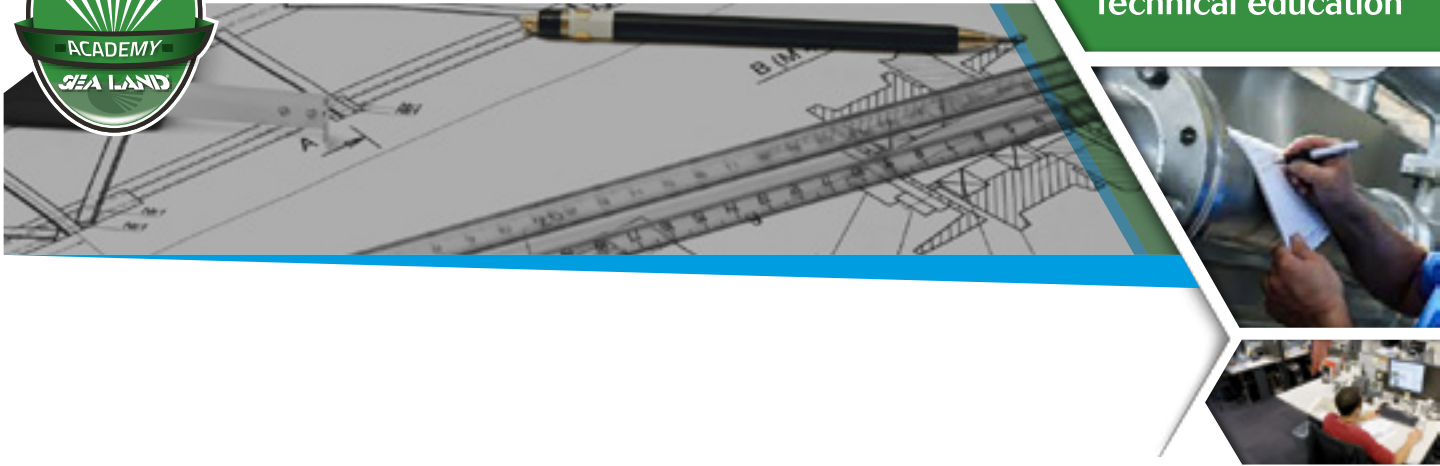

FKM is known especially for its non-flammability, low gas permeability and excellent resistance to ozone, weathering and ageing.

The operating temperatures of the Fluorocarbon Rubber range in water between -20°C and $+95^{\circ}\text{C}$. FKM is also often used with mineral based oils and greases at high temperatures ($+200^{\circ}\text{C}$).

ELASTOMERS: RUBBER TEMPERATURE LIMITS (IN WATER)

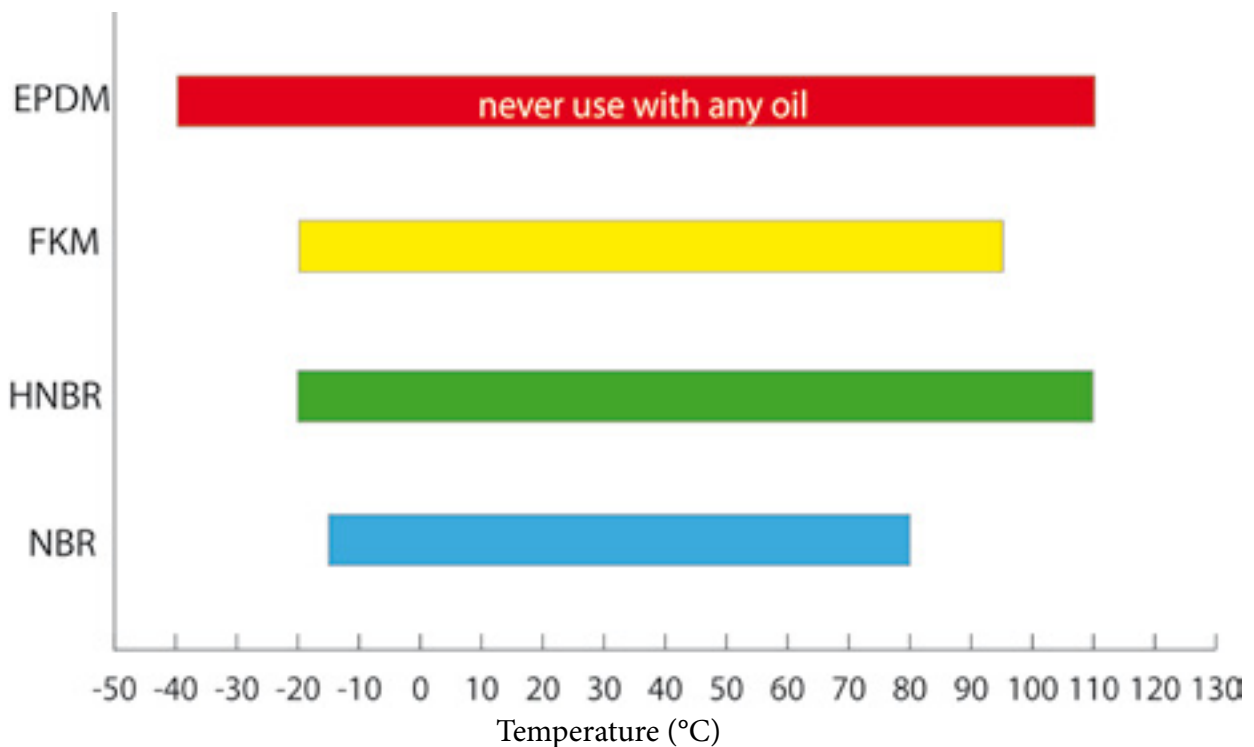

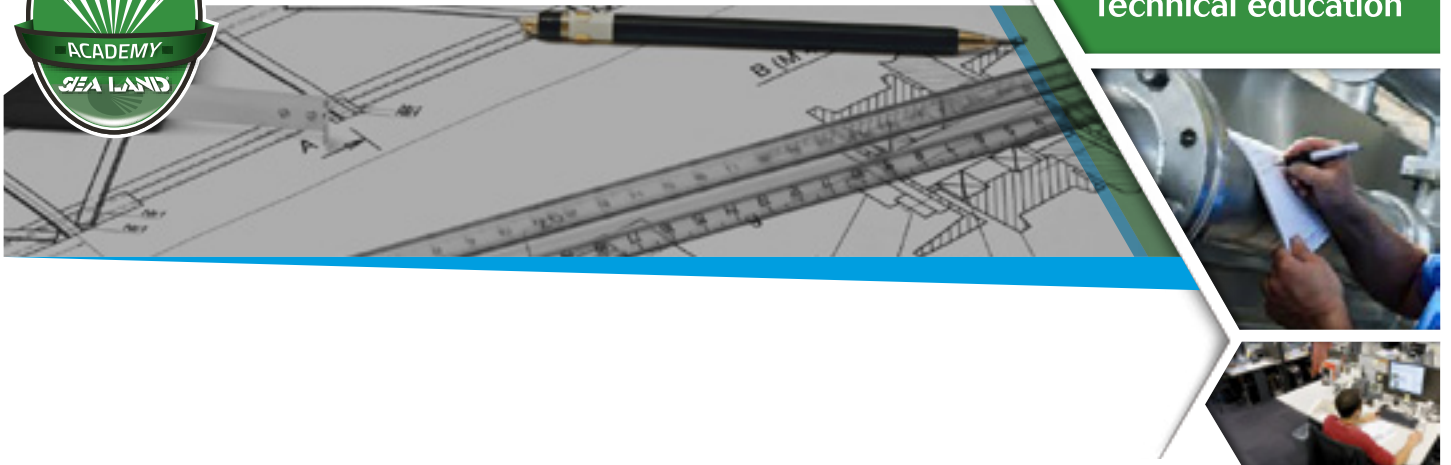

4.3 NON ELASTOMERS

Polytetrafluoroethylene (PTFE), e.g. Teflon®

Polytetrafluoroethylene (PTFE) is a polymer of tetrafluoroethylene which has a set of physical-chemical properties, which can ensure:

- Extreme chemical inertness
- Excellent heat resistance
- Excellent dielectric characteristics
- No hygroscopicity and maximum resistance to solvents
- Excellent resistance to aging effect
- Self-lubricating characteristics and low coefficient of friction.

Used as a secondary seal, PTFE has an excellent heat and chemical resistance with almost all liquids, except for some solutions of alkali metals and fluorinated solutions.

The application range is from $-60\text{ }^{\circ}\text{C}$ to $+200\text{ }^{\circ}\text{C}$.

On the other hand, PTFE is a material that easily deforms plastically, has a low coefficient of thermal conductivity and its coefficient of thermal expansion is greatly dependent on the temperature.



5. MATERIALS CODES IN ACCORDANCE TO EUROPEAN STANDARD EN 12756

Below are the material codes according to the European standard EN 12756 for the materials commonly used in mechanical seals.

SEAL FACE / SEAT

Carbons

- A Carbon, metal-impregnated
- B Carbon, resin-impregnated
- C Other carbons

Metals

- D Carbon steel
- E Cr steel (AISI 420)
- F Cr-Ni steel (AISI 304)
- G Cr-Ni-Mo steel (AISI 316)
- S Cr cast steel

Carbides

- U1 Tungsten carbides, Co-bonded
- U2 Tungsten carbides, Ni-bonded
- Q1 SiC
- Q2 SiC-Si
- J Other carbides

Metal oxides

- V Aluminium oxide
- X Other metal oxides

Plastics

- Y1 PTFE, glass-fiber reinforced
- Y2 PTFE, carbon reinforced

RUBBER PARTS

Elastomers

- E Ethylene propylene rubber (EPDM)
- K Perfluoro rubber (FFKM)
- P Nitrile rubber (NBR)
- S Silicon rubber (VMQ)
- V Fluoro rubber (FKM)
- X Other elastomers

Non-Elastomers

- T PTFE

SPRINGS AND OTHER METALLIC PARTS

- D Carbon steel
- E Cr steel (AISI 420)
- F Cr-Ni steel (AISI 304)
- G Cr-Ni-Mo steel (AISI 316)
- M High-nickel alloy (eg. Hastelloy)

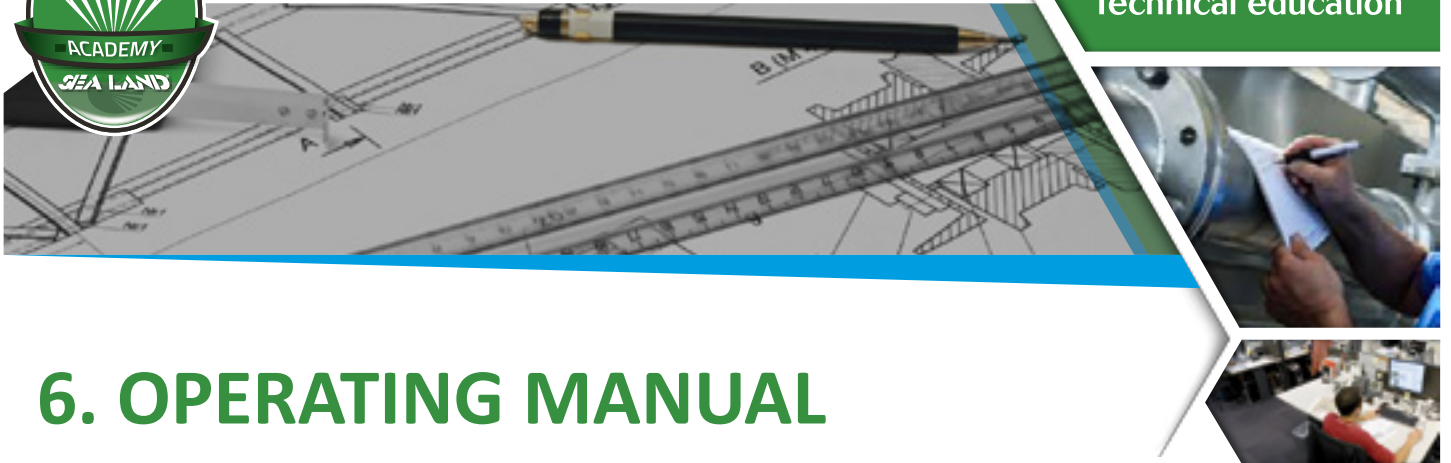

6. OPERATING MANUAL

6.1 OBJECT AND APPLICATION FIELD

This Technical Specification is the operating manual for assembly, operating condition and maintenance of EagleBurgmann BT mechanical seals.

To ensure optimum seal performance and to avoid any inconvenience or malfunction, please carefully READ and OBSERVE the following operating instructions. In the event of any doubt, please contact EagleBurgmann BT. This procedure is valid for all BT mechanical seals, listed as follow:

Rubber bellows seals, independent rotation direction, type

- AR / AR3
- PN / PNL
- PNT
- A2
- A3
- ARP

Pusher seals with conical spring, type

- RN / RN3 / RN6
- FN / FN.NU / FN.KU

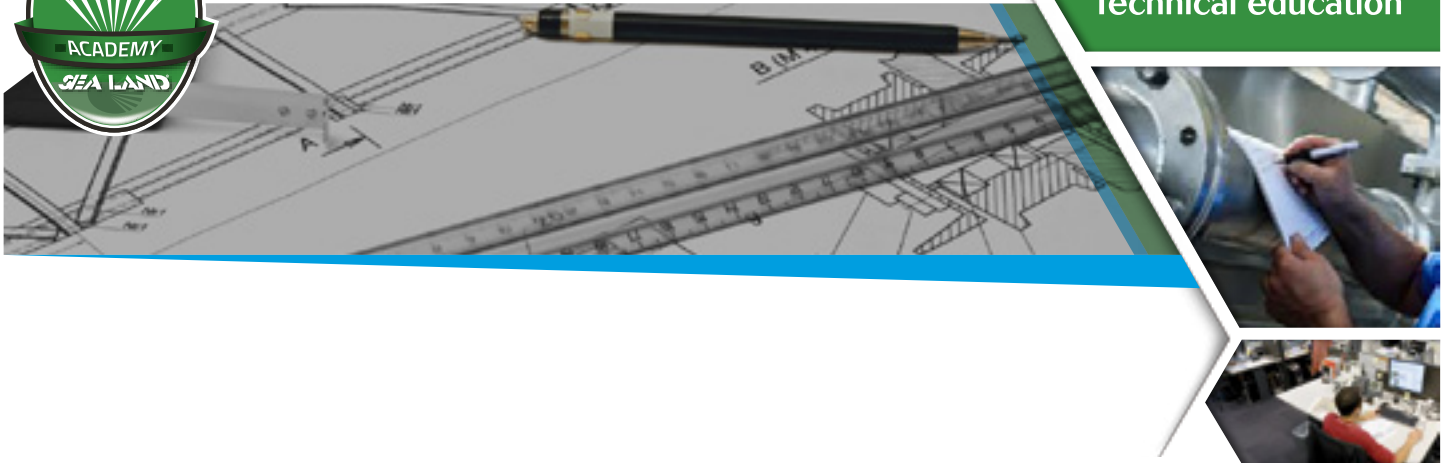

- FH / FHC / FH6 / FH.NU / FH.KU
- RN.NU / RN3.NU / RN6.NU / RN.KU / RN3.KU / RN6.KU
- RN.NB / RN3.NB / RN.KB / RN3.KB
- FH.NB

Pusher seals, multi-springs, independent rotation direction, type

- C5.KU / C56.KU
- C5.KB / C56.KB
- C5E / C53E
- C7 / C73
- C8

6.2 SAFETY

Any person being involved in assembly, disassembly, start-up, operation and maintenance of the EagleBurgmann BT mechanical seals must have read and understood this operating manual and in particular the safety notes. We recommend the user to have this confirmed in writing.

The EagleBurgmann BT mechanical seals are manufactured on a high-

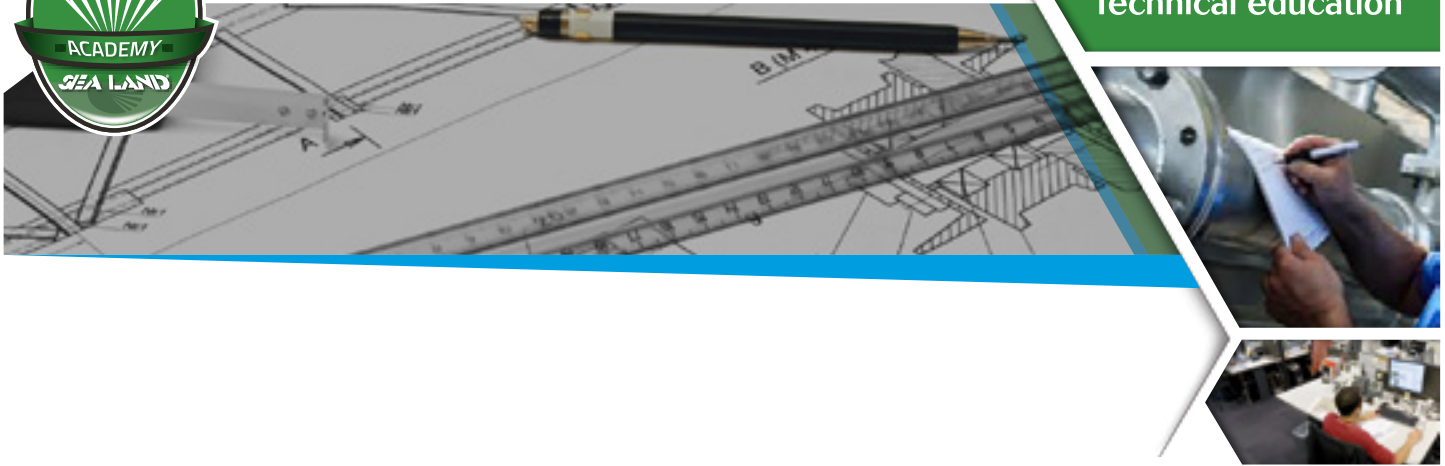

quality level (the Company has obtained the quality system certification UNI EN ISO 9001), and they keep a high working reliability.

Nevertheless, if the mechanical seals are not operated within their intended purpose or handled inexpertly by untrained personnel, they may cause risks.

The user has to check what effects a failure of the mechanical seal might have and what safety measures have to be taken to prevent personal injury or damage to the environment.

The pump has to be put up in such a way that seal leakage can be led off.

The pump has to be disposed properly to avoid any injury caused by spurting product in the event of a seal failure.

The EagleBurgmann BT mechanical seals must be operated, maintained or repaired by authorized, trained and instructed personnel only. In principle, any work to be done on the mechanical seal is permitted when the seal is neither operating nor pressurized.

The responsibilities for the respective jobs to be done have to be determined clearly and observed to prevent unclear competencies from the point of safety.

Apart from the notes given in this manual, the general regulations for worker's protection and the prevention of accidents have to be observed.

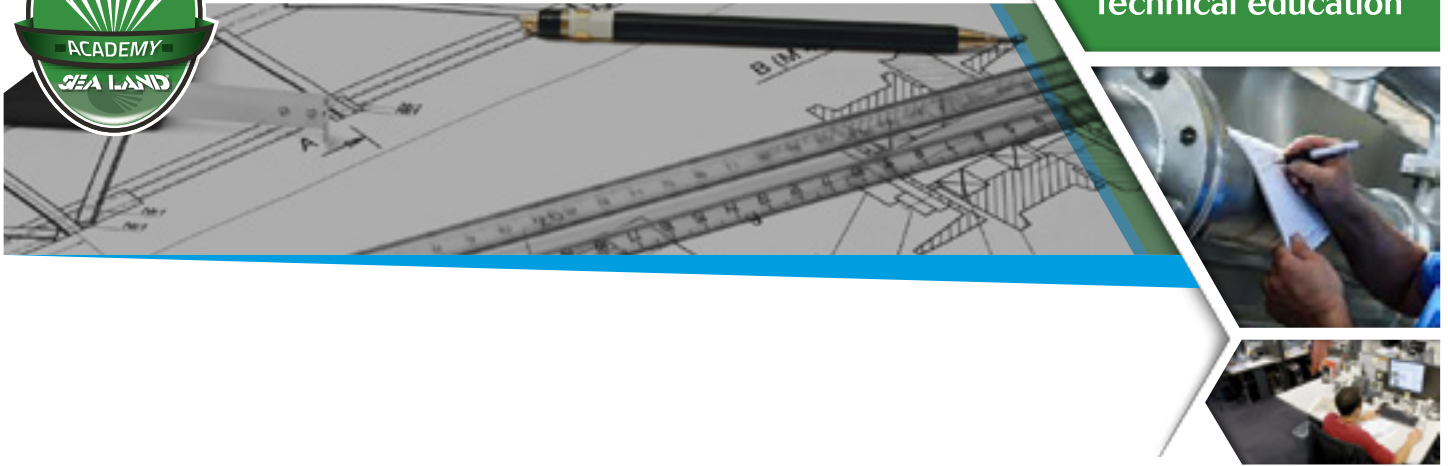

Unauthorized modifications or alterations which affect the operational safety of the mechanical seal are not permitted.

6.3 EUROPEAN DIRECTIVES

Directive 2006/42/EC so called “Machine Directive”: Mechanical seals are not under the range of application of the Machinery Directive.

Directive 2014/34/EU “ATEX Directive”: The EagleBurgmann BT mechanical seals can be used in some ATEX applications. If the user needs this requirement, please contact our offices to check if the working parameters are included in the range of application of our products.

Directive 98/83/EC concerning the quality of water for human use: the EagleBurgmann BT mechanical seals may be used for this kind of applications, but not with all the combination of materials. In this case the user should contact our offices to verify the compatibility of the materials.

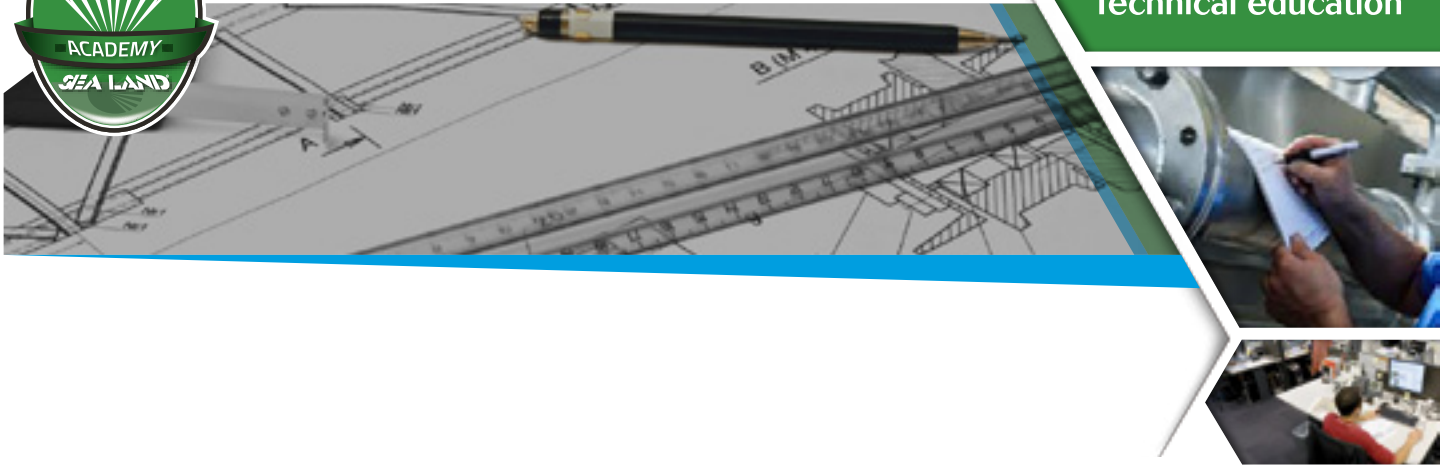

6.4 OPERATING LIMITS

The operating limits for EagleBurgmann BT mechanical seals are indicated in the catalogue.

| | | |
|-----------------------|-------------------|-----------------|
| Operating conditions: | Shaft diameter | d_1 [mm] |
| | Working pressure | p_{max} [bar] |
| | Media temperature | t [°C] |
| | Sliding velocity | v [m/s] |

Operation exceeding the max operating limits are not allowed

Higher loads (pressure, temperature, speed) can increase wear or lead to damage sliding faces or elastomers. This could result in a seal shorter life time and in the risk of a sudden seal failure, dangerous for people and environment.

If the seal has to be operated under different condi-



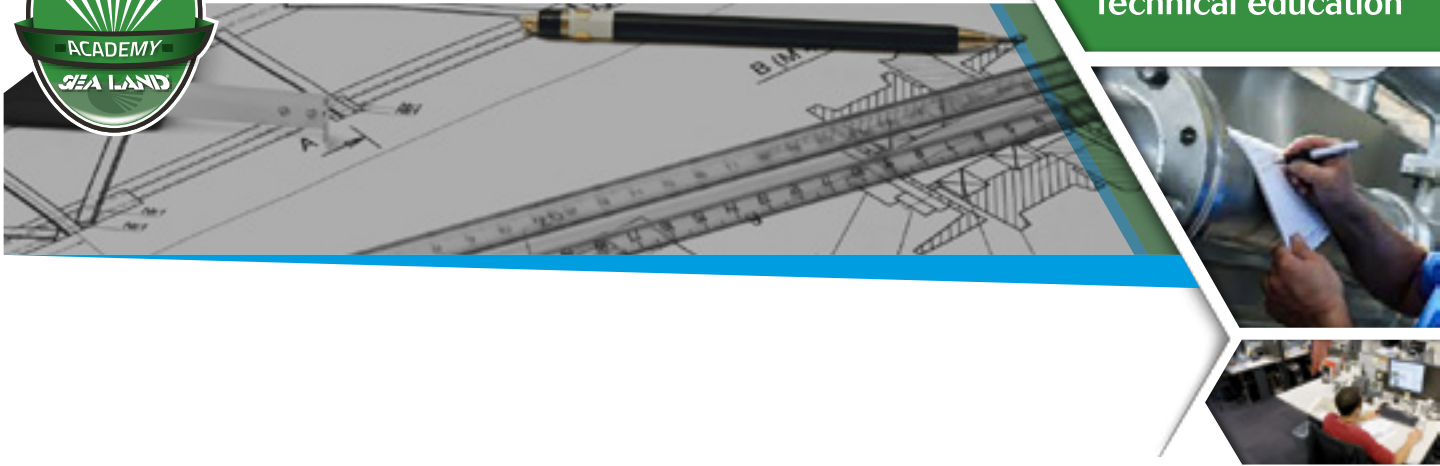

| Seal type | Diameter d_1 | Pressure $p_{max}^{(*)}$ | Temperature $t^{(**)}$ | Velocity $v^{(*)}$ |
|---------------------------------|----------------|--------------------------|------------------------|--------------------|
| AR - AR3 | 6 ÷ 60 | 6 | -20 ÷ +120 | 10 |
| RN - RN3 - RN6 | 8 ÷ 110 | 12 | -35 ÷ +180 | 15 |
| FN - FN.NU - FN.KU | 10 ÷ 40 | 12 (16) | -35 ÷ +180 | 15 |
| FH - FHC - FH6 - FH.NU - FH.KU | 10 ÷ 100 | 12 (16) | -35 ÷ +180 | 15 |
| FH.NB | 16 ÷ 70 | 25 | -35 ÷ +180 | 15 |
| PN - PNL | 8 ÷ 40 | 12 | -20 ÷ +120 | 10 |
| PNT | 1/2" ÷ 3/4 | 12 | -20 ÷ +120 | 10 |
| A2 | 1/2" ÷ 3/4 | 4 | -20 ÷ +90 | 10 |
| A3 | 14 ÷ 16 | 12 | -20 ÷ +120 | 10 |
| ARP | 20 ÷ 40 | 6 | -20 ÷ +90 | 10 |
| RN.NU - RN3.NU - RN6.NU | 10 ÷ 100 | 12 | -35 ÷ +180 | 15 |
| RN.KU - RN3.KU - RN6.KU | 10 ÷ 100 | 12 | -35 ÷ +180 | 15 |
| RN.NB - RN3.NB - RN.KB - RN3.KB | 10 ÷ 100 | 25 | -35 ÷ +180 | 15 |
| C5.KU - C56.KU | 20 ÷ 100 | 12 (16) | -35 ÷ +180 | 20 |
| C5.KB - C56.KB | 18 ÷ 100 | 25 (40) | -35 ÷ +180 | 20 |
| C5E - C53E | 20 ÷ 80 | 12 | -35 ÷ +180 | 15 |
| C7 - C73 | 16 ÷ 100 | 12 (16) | -35 ÷ +180 | 20 |
| C8 | 16 ÷ 100 | 12(16) | -35 ÷ +180 | 20 |

(*) The operating limits change in accordance with the materials of the sliding faces and directly depend on the PV factor.

(**) The temperature range depends from the elastomer used in the secondary seal elements.

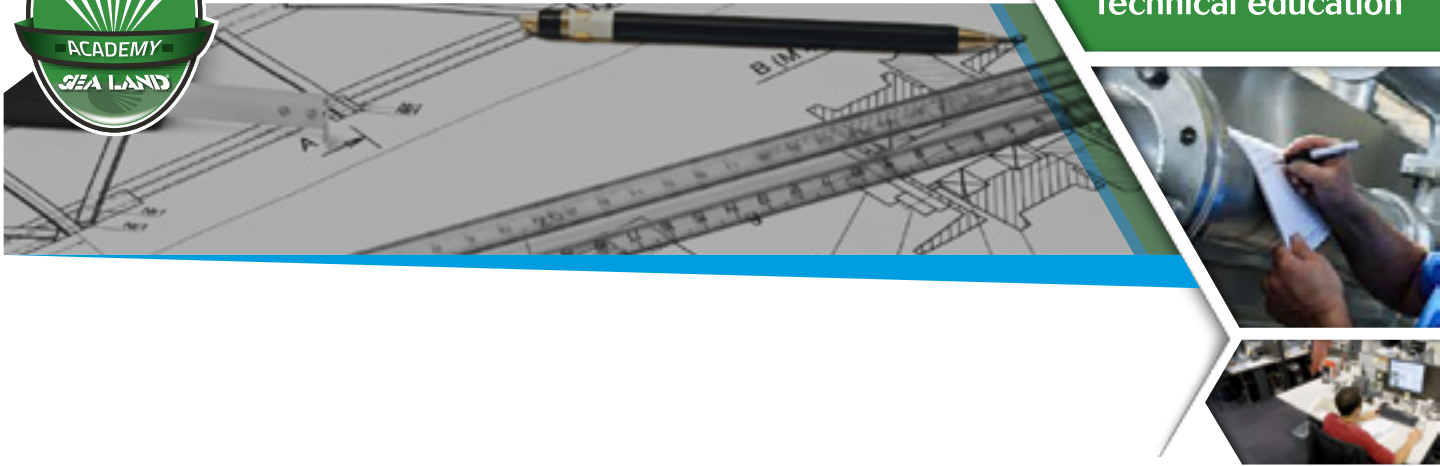

tions than those indicated, consultation with our offices is recommended.

6.5 TEMPERATURE LIMITS FOR ELASTOMERS

The following table shows the allowed temperature range, in Celsius degree, for conventional o-ring (elastomers and non-elastomers):

| Elastomers | (*) | Temperature (°C) | Notes |
|--------------------------------|-----|------------------|-------------------------------------------|
| Nitrile butadiene rubber (NBR) | P | -20 ÷ +90 | |
| Chloroprene rubber (CR) | C | -30 ÷ +120 | |
| Ethylene propylene (EPDM) | E | -40 ÷ +140 | not resistant to mineral oils and greases |
| Silicone rubber (VMQ) | S | -50 ÷ +200 | |
| Fluorocarbon rubber (FKM) | V | -20 ÷ +200 | in hot water max +90°C |
| Butyl rubber | B | -40 ÷ +110 | not resistant to mineral oils and greases |
| Perfluorocarbon rubber (FFKM) | K | -5 ÷ +270 | possible swelling in fluoride solvents |
| PTFE | T | -200 ÷ +250 | |

(*) material designation according EN12756

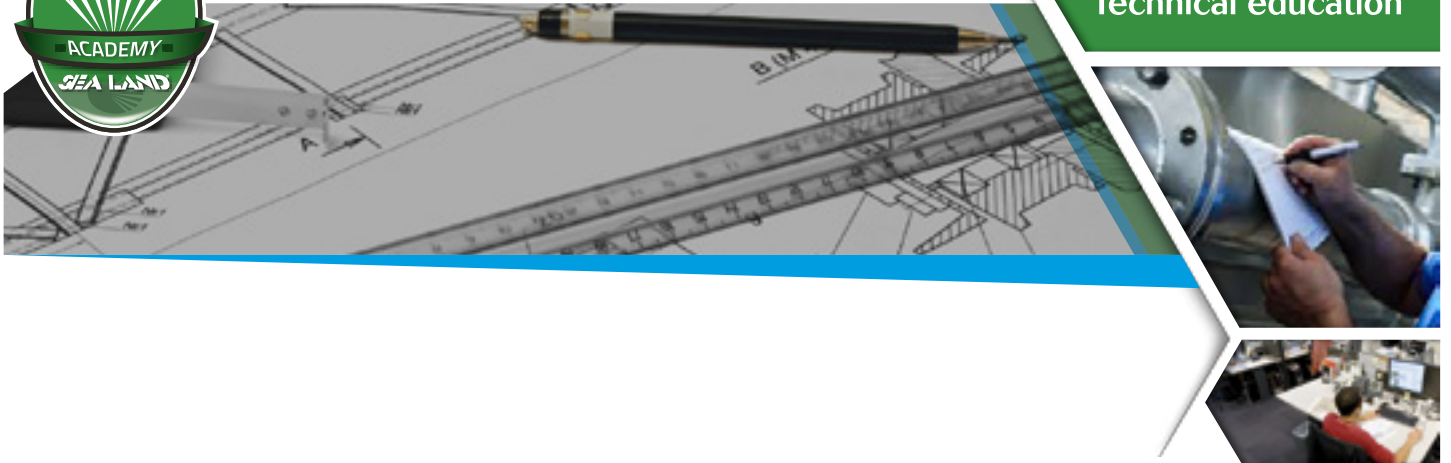

6.6 WORKING CONDITIONS

The mechanical seal should constantly be wetted by liquid media. It is important to avoid a dry running of the seal.

The media to be sealed should not damage the mechanical seal chemically (corrosion, embrittlement) nor physically (erosion, abrasion).

The seals also fit to be used as multiple mechanical seals in a tandem arrangement together with a quench supply or as double mechanical seals together with a fluid barrier system.

In case of double opposite mechanical seal assembly, we recommend using a barrier fluid suitable for the circulating product, at a pressure of $1,5 \div 2$ bar higher than the fluid to be sealed.

6.7 EMISSIONS (LEAKAGES)

A mechanical seal is a dynamic seal that cannot be free of leakage due to physical and technical reasons. Seal design, manufacture tolerances, operating conditions, quality of the machine, etc. mainly define the leakage value. In fact, compared to other dynamic sealing systems, a mechanical seal has a smaller leakage. A possibly increased leakage

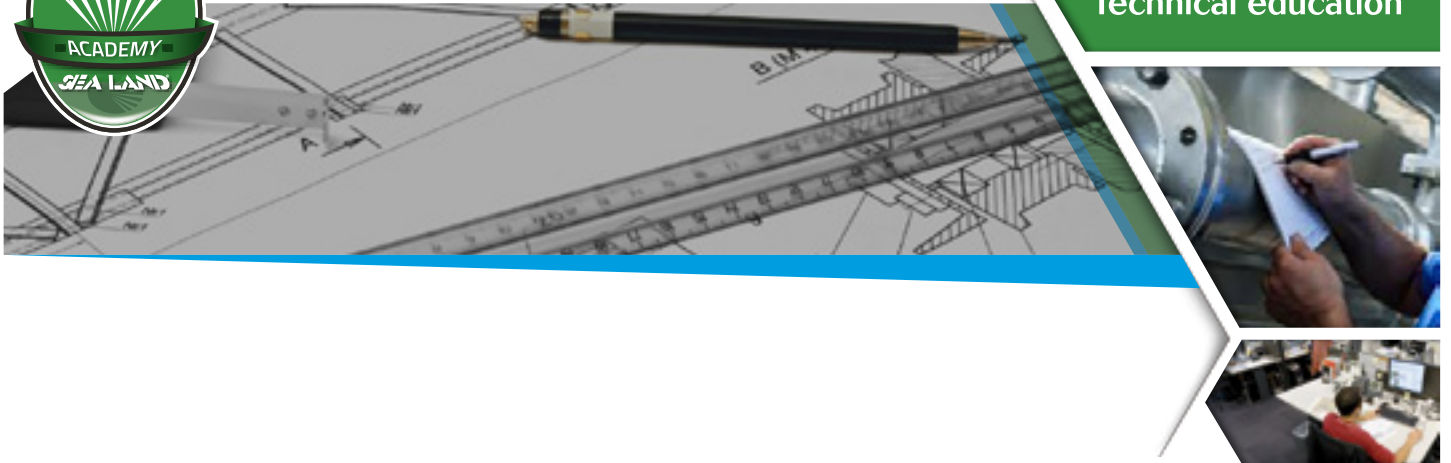

during start-up will decrease to a reasonable quantity after the running-in period of the sliding faces.

The leakage can be liquid or gaseous, depending on the aggressiveness of the medium to be sealed.

The medium may splash out if the seal fails.

Personal injury may be prevented by the user providing for splash protection and wearing safety glasses.

The user has to take care of proper disposal of the leakage.

Leakage of the mechanical seal at the outboard side has to be drained and disposed properly.

Components which may get in contact with the leakage have to be corrosion-resistant or have to be properly protected.

6.8 TRANSPORT

If not specified differently by contract, the EagleBurgmann BT standard packing is used which is suitable for dry transport by truck, train or plane.

The warning indications and notes on the packing must be observed.

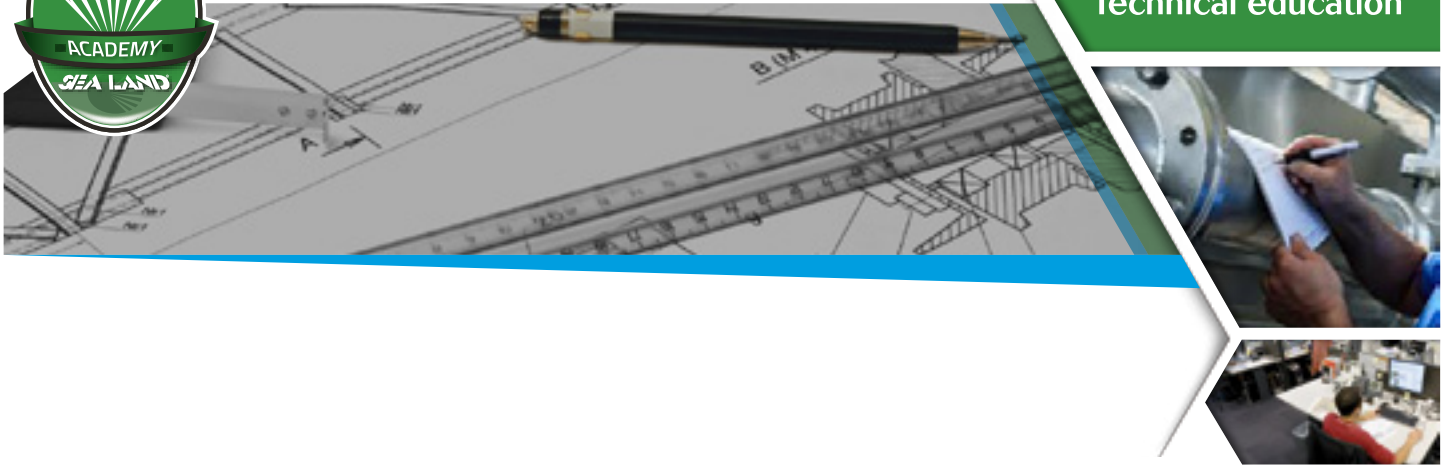

Notes for incoming inspection:

- Check packaging for visible damage
 - Open packaging carefully. Do not damage or lose parts supplied
- Check if consignment is complete (delivery note).

6.9 STORAGE¹

These instructions apply to all EagleBurgmann BT mechanical seals which have been supplied and stored in their undamaged original packaging as well as to seals which have been installed in a component of a plant (e.g. pump, compressor, agitator, etc.), but have not been put into operation yet.

A preservation of the EagleBurgmann BT mechanical seals is not necessary. Do not use anticorrosive. Sliding materials and elastomers are subject to material-specific and time-based alterations (distortion, aging) which might reduce the full efficiency of the seals. This may be avoided by observing the storage instruction.

Damages caused by improper storage may not be claimed on the EagleBurgmann BT company concerning their warranty.

Store the mechanical seals in their original packing, lying on a flat sur-

¹ For storage of elastomers parts, following International Norm ISO 8331



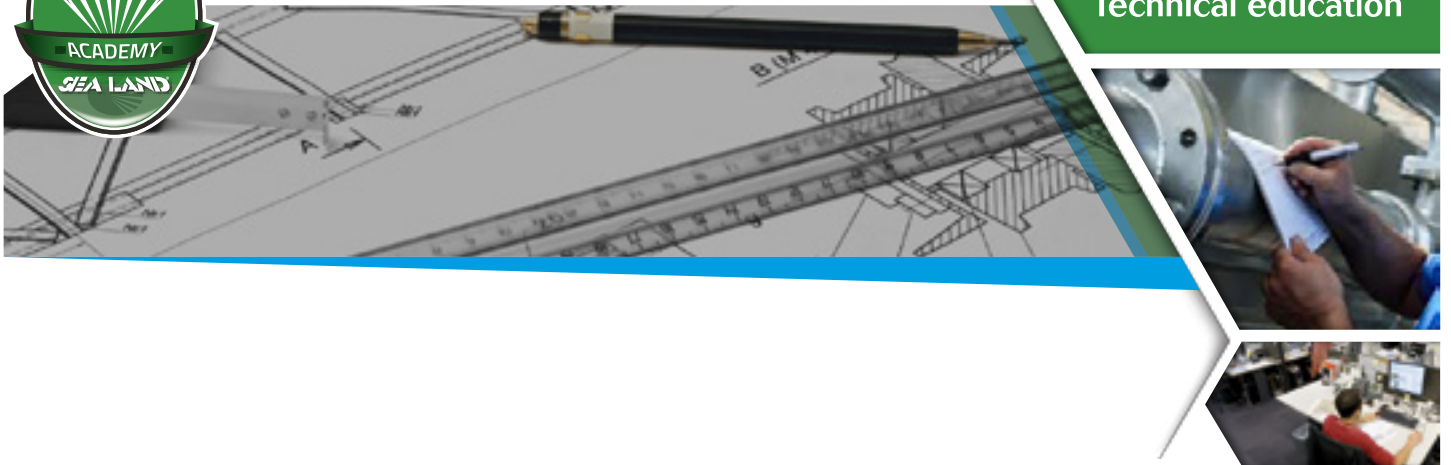

face.

Indications for storage of mechanical seals:

- constantly tempered (relative air humidity below 70%; optimal temperature should be around 25°C; storage temperature must be in the range of -30°C / 50°C)
- dust-free
- moderately ventilated

Protect the seal from:

- direct exposure to heat sources (sun, heating)
- ultraviolet light (arc welding, halogen or fluorescent lamps, sunlight)
- risk of embrittlement or swelling of elastomeric materials
- direct contact with chemical agents (never put EPDM elastomers in contact with mineral oil and grease)
- Ozone potential sources (high voltages sources, electric motors, etc)

Check the mechanical seal:

- after a storage period of approximately 2-3 years
- in case of a damage of the packing

after a shock on the mechanical seal (e.g. by dropping down the packed seal).

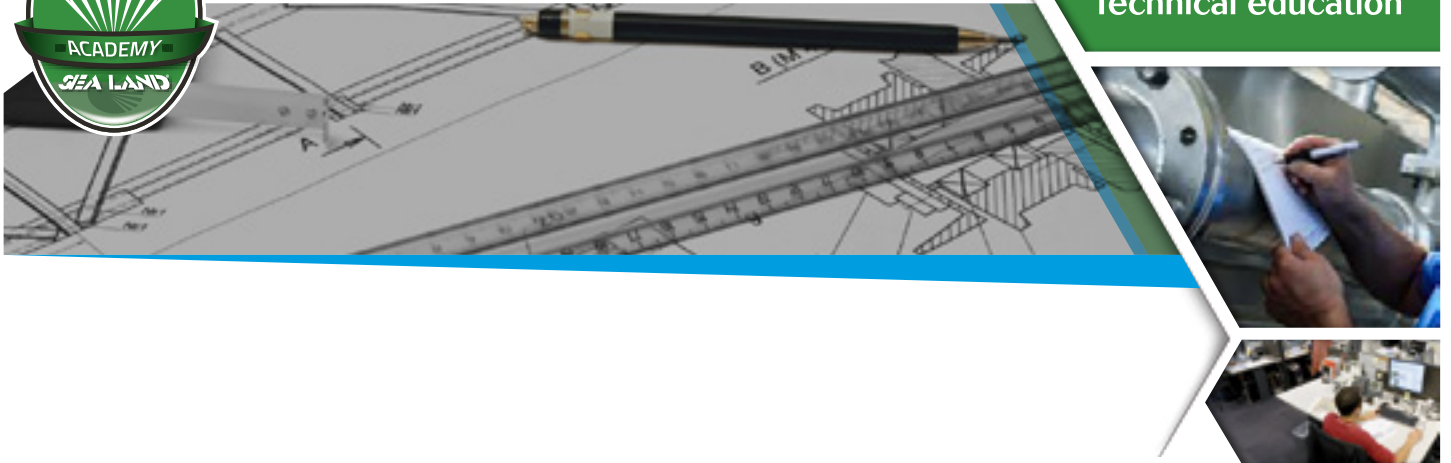

6.10 PRELIMINARIES TO ASSEMBLY

Preliminary controls at the machine:

- All connecting surfaces free from burrs and sharp edges;
- Radiuses transitions;
- Chamfered edges;
- Ensure that quotes and tolerances of the shaft and seat diameters are strictly observed (refer to EagleBurgmann BT catalogue or to EagleBurgmann BT technical dept. specific drawings);
- Provide a shoulder or stop device for the seal driver to take up the axial forces;
- To fit at the assembly quote our BT-PN and BT-PNL mechanical seals, with back ring, in case of lock with seeger ring, it is suggested to insert a 2-3 mm spacer ring between the seeger and the back ring to avoid a deformation of the back ring itself.

Shaft and seat finished surfaces:

- For bellows mechanical seals (BT series AR, PN, PNL, PNT and A3) shaft finishing must have a roughness Ra from 0,6 μm to 1 μm ;



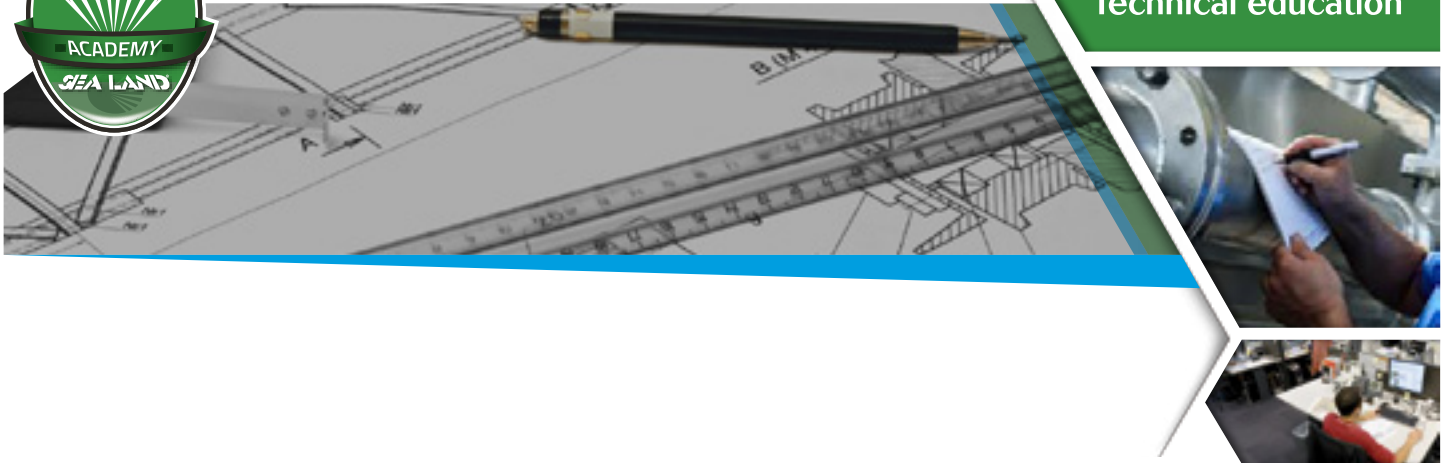

- For o-ring mechanical seals (BT series RN, FN, FH and C5) shaft finishing must have a roughness Ra from 0,4 μm to 0,6 μm ;
- For PTFE wedge mechanical seals (BT series RN6, FH6 and C56) shaft finishing must have a roughness Ra \leq 0,2 μm ;
- The seat surface must have a roughness Ra \leq 2,5 μm in case of stationary seats with elastomers, and a roughness Ra \leq 1,6 μm in case of stationary seats with PTFE.

Check at the machine:

- Damage of connecting surfaces to the mechanical seals;
- Matching dimensions, rectangularity and concentricity to the shaft axis - concentricity accuracy of the shaft, according to ISO 5199:
 - Diameters up to 50 mm: max 0,05 mm
 - Diameters 50 \div 100 mm: max 0,08 mm
 - Diameters exceeding 100 mm: max 0,1 mm;
- Axial run-out: it is the axial oscillation of the seal surface measured on a single complete shaft rotation.

The run-out tolerances depend on the shaft rotation speed.

Exceeding the above values, the seal life decreases and fluid leakages can occur.

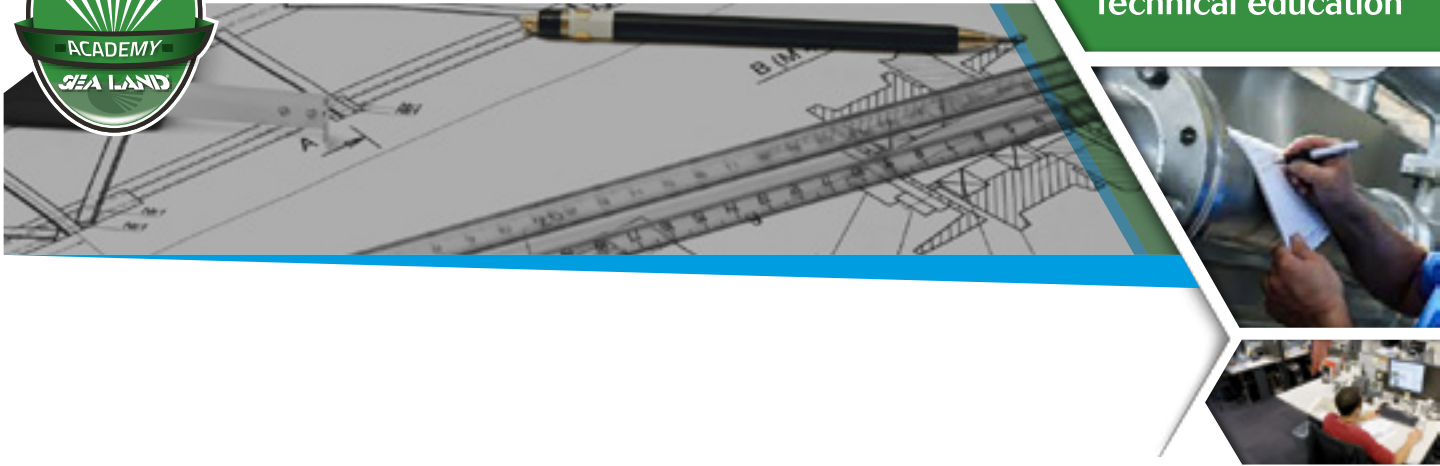

Run-out and tolerances

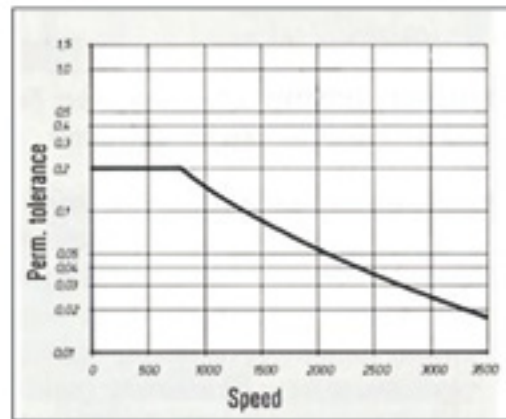
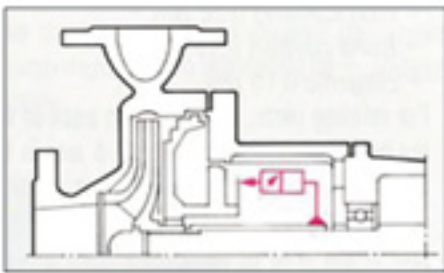

6.11 UTILITIES AND TOOLS

For an easy seal assembly, the following utilities and tools are suggested:

- Ethyl alcohol
- Water and detergent (water and soap solution at 2%)
- Pusher tools
- Mounting sleeves or cones

6.12 ASSEMBLY

The EagleBurgmann BT mechanical seals are precision components re-

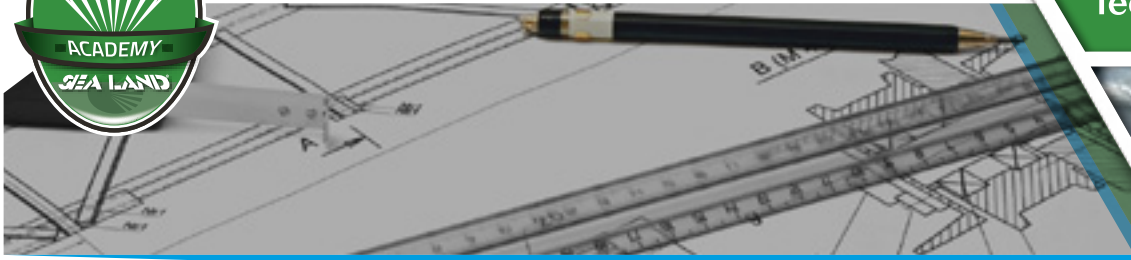

quiring particular attention during assembly. The seal should remain packed until the assembly; operations have to be done in dust-free surroundings. Cleanness must be as well observed for the different pump components, as chips and blasting traces can damage the seal irreparably.

Should any seeger seats, locks for keys or sharp-edged seats be present on the shaft, the use of pushers or mounting sleeves is required, thus avoiding to compromise the secondary seals integrity (cuts on bellows or o-rings).

For installation, the assembly drawing of the mechanical seal (working length and the related dimensions) has to be available.



At this point:

- Unpack the seal and check seal face, seat and elastomer bellows for possible damages.
- Ensure that the sliding faces are perfectly clean from greases, oils and any dirty (possible leakage).
- Preferably mount the seal dry by the use of pushers.

In case of severe assembly, to reduce the seal friction, sprinkle the seat

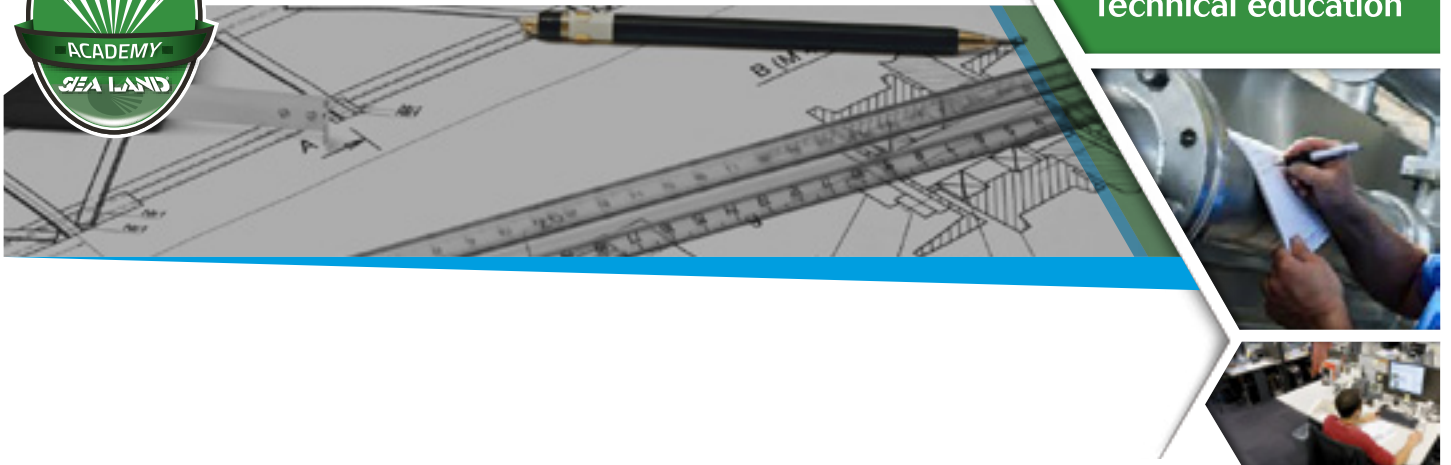

or the shaft with ethyl alcohol (or water + 2% detergent) ensuring the sliding faces remain dry and clean.

Oil or grease as assembly agent has to be avoided absolutely.

- For BT bellow seals (series BT-AR, BT-PN, BT-PNL, BT-PNT, and BT-A3) push the rotating seal unit (bellows) with a slow clockwise turn onto the shaft until the bellows shoulder is settled on the shaft. Keep the shaft wet if the distance to slide the seal is rather long.

- Do not use any lubricant on the seal surfaces.

Seal surfaces must be clean and dry.

- Never assembly the seal out of the installation tolerances suggested by EagleBurgmann BT catalog or drawing, ensure that the seal is perfectly settled on its stop.

Do never force during installation.

Absolutely avoid the seal is having impacts or shocks.

If by accident the seal drops to the ground, its integrity must be verified and eventually replace the seal with a new one.

Never put EPDM elastomers in contact with mineral oils or greases.

For any problem or anomaly, please contact our technical department for the proper explanations and information.

Following the above instructions helps to avoid damages to the sealing system and subsequent leakage.

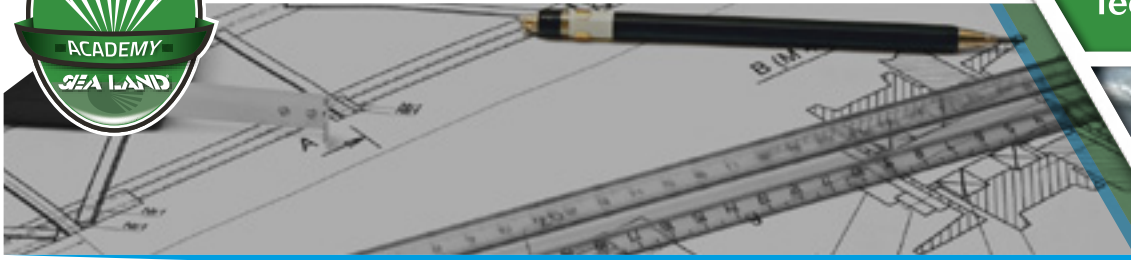

- Example of assembly of the rotary unit BT-AR seal (straight assembly)

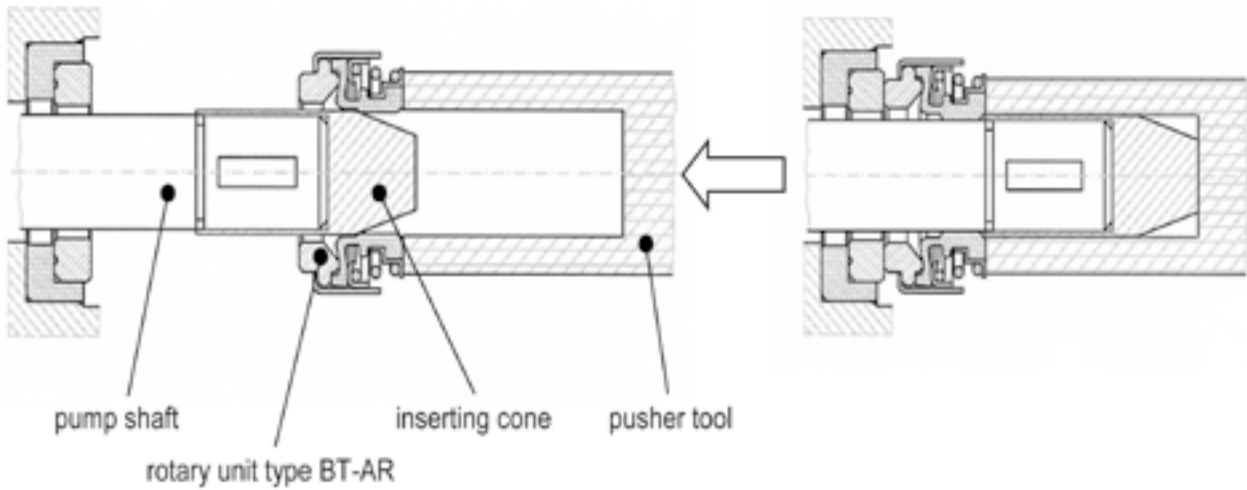

- Example of assembly of the rotary unit BT-AR seal (reverse assembly)

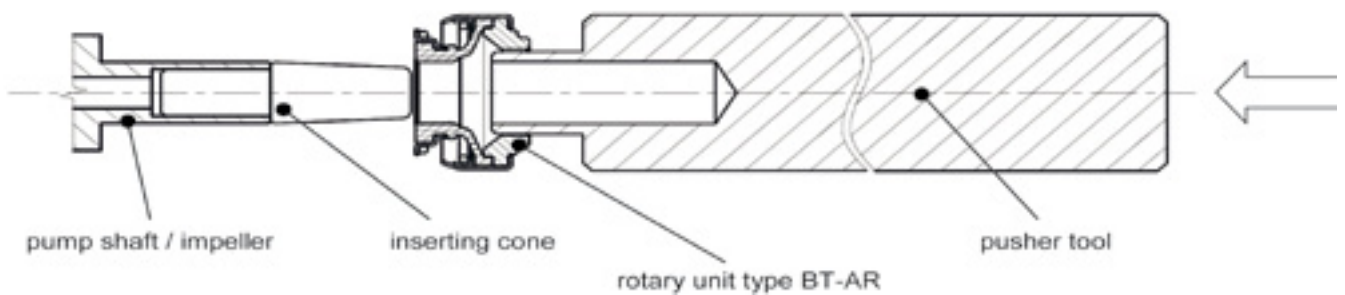

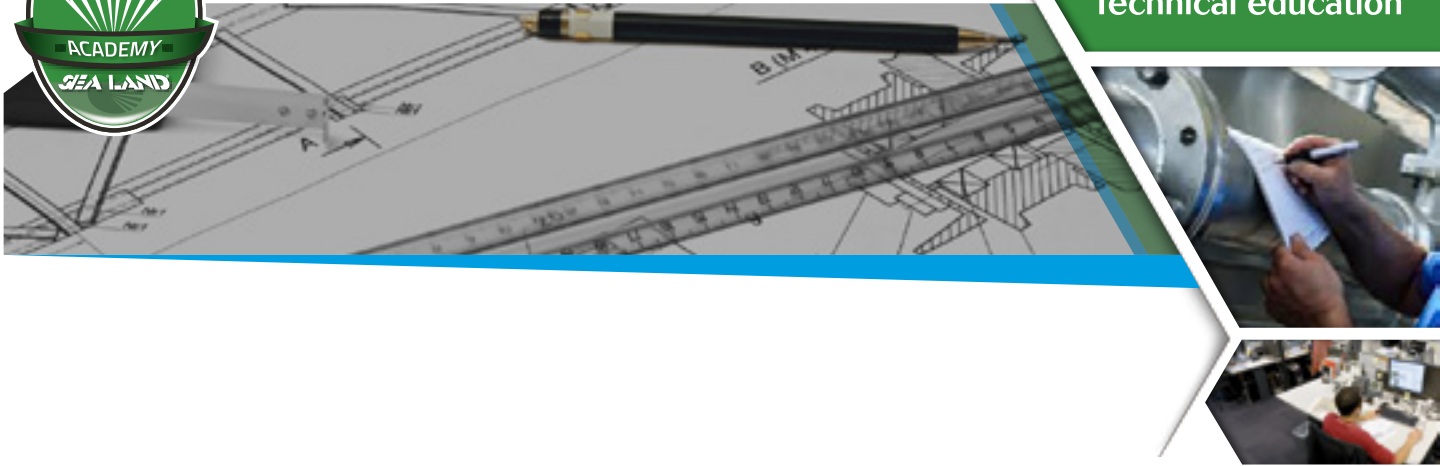

- Example of assembly of a stationary “C” shaped seat

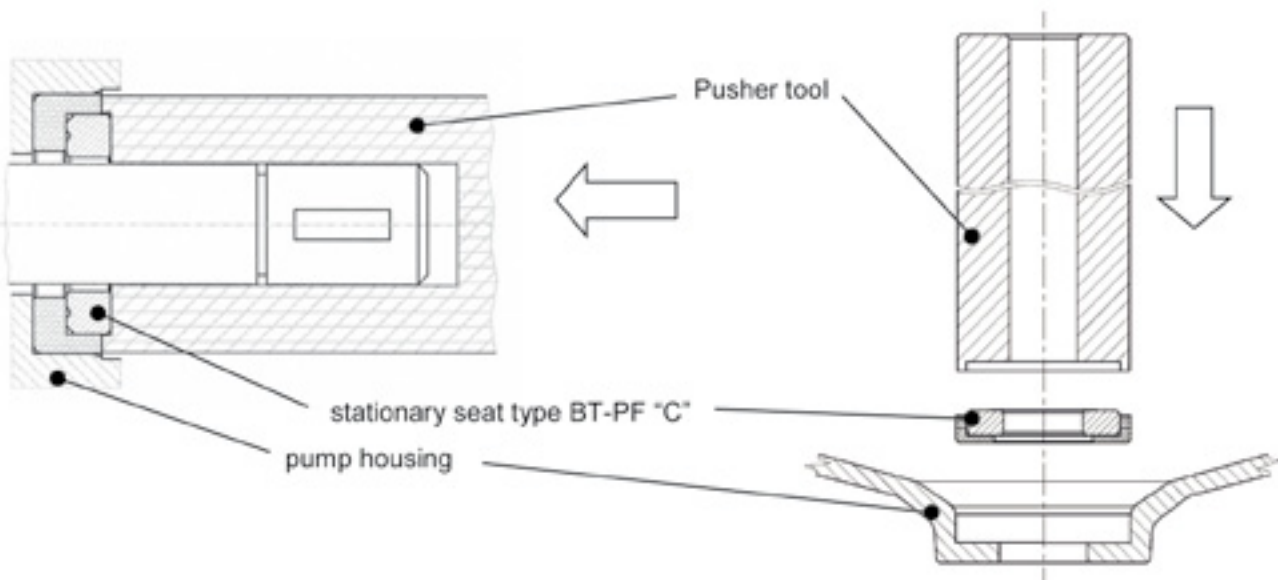

6.13 DIRECTION OF ROTATION

The EagleBurgmann BT mechanical seals types AR, PN, PNL, PNT, A2, A3 and C5 have independent rotation direction, could be assembled on machines having both clockwise or anticlockwise direction of shaft rotation. The EagleBurgmann BT mechanical seals types RN, FN, and FH, driven by a conical spring, have dependent direction of rotation, therefore it must be ensured that, looking toward the seal face, the shaft direction of rotation and the winding direction of the conical

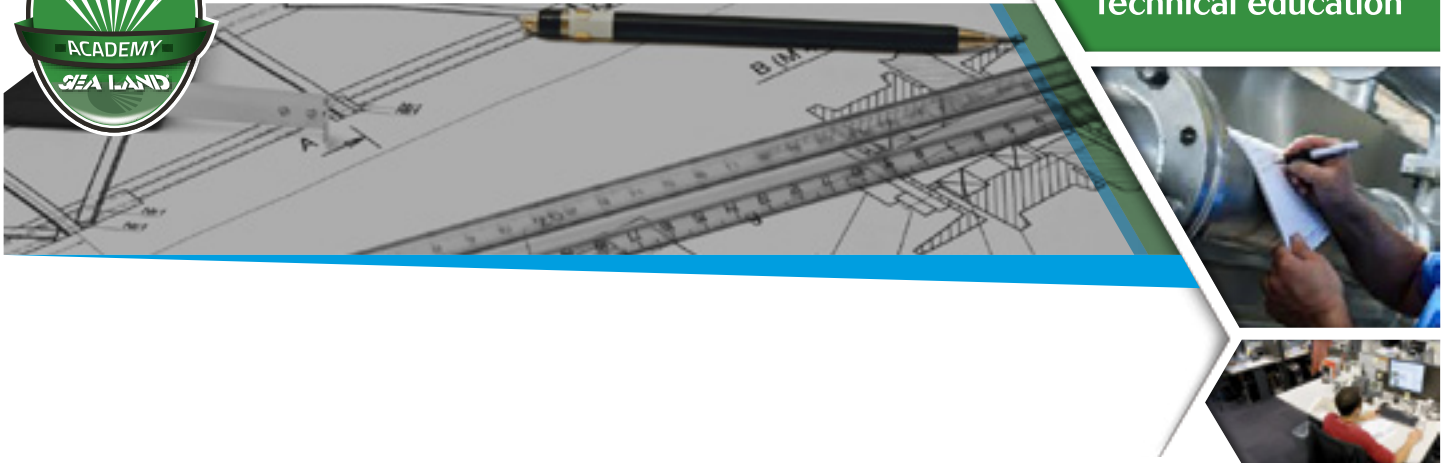

spring (left-hand or right-hand thread) must be the same.

6.14 START UP

Flood pump and seal cavity (stuffing box) with media and vent thoroughly.

To prevent damage of the sliding faces from dry running, the buffer space must be carefully vented.

Now the seal is ready for operation.

The mechanical seal constantly has to be wetted by the product in its liquid form, especially when the pump is started or stopped.

The pump design has to be done to consider this need (e.g. heating of the product).

Never start the machine in dry conditions (dry running) to avoid irreparable damages of the sliding faces. If the operation limit values and the instructions given in this manual are observed, a trouble-free operation of the mechanical seal can be expected.

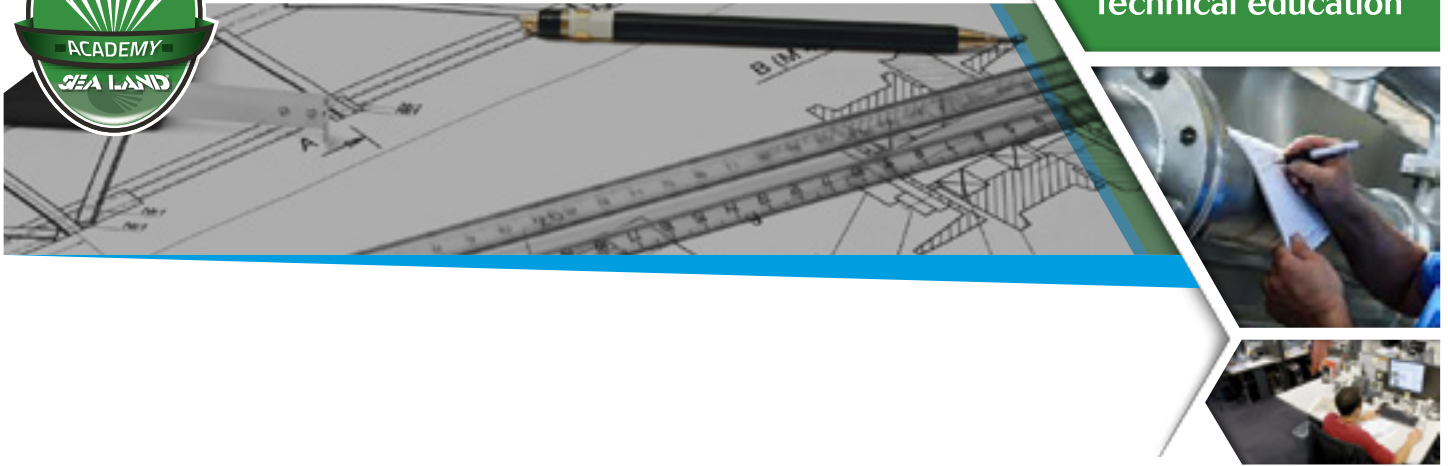

6.15 WORKERS PROTECTION

The EagleBurgmann BT mechanical seals are seldom used for sealing hazardous substances (chemical, medical substances, etc.). If this is the case, the valid regulations for handling hazardous substances have to be observed by all means.

Media may splash out if the seal fails.

Personal injury may be prevented by the user, providing for splash protection and wearing safety goggles, etc., as well as take care for proper disposal of the leakage.

6.16 TROUBLES DURING OPERATION

In case of failure due to high leakage, the amount of leakage should be observed.

Changes in the operating conditions have possibly to be recorded.

In case of hazardous substances leakage from the mechanical seal, the machine must be shut down for safety reasons.

A continuous, flowing leakage indicates that the seal is damaged and must be replaced.

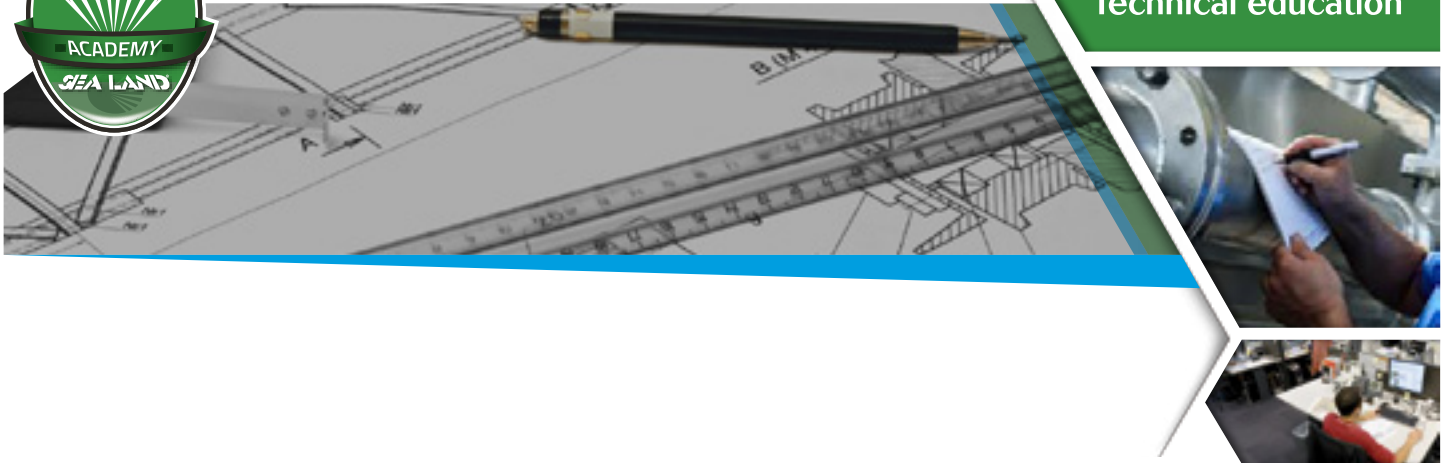

6.17 MAINTENANCE

The correctly operated mechanical seal needs no maintenance.

Wear parts, however, have to be replaced if necessary (e.g. o-ring parts).

An inspection of the mechanical seal should be carried out during a revision of the machine.

If the mechanical seal is disassembled during a revision of the plant, it should be replaced by a new one.

6.18 REPAIR

In case of seal failure, it should be replaced by a new one.

It's recommended to store a complete seal for a quick replacement, as spare parts.

If the repair has to be done on site, it should be carried out in a clean room, preferably by trained personnel.



6.19 SEAL REMOVAL

- Shut down the pump in duly procedure, let it cool down and depressurize it.
- Drain the pump if necessary.
- Secure the pump against inadvertent start.
- Observe the safety notes.

In principle, any work to be done on the mechanical seal is allowed only when the seal is neither operating nor pressurized. We recommend following the regulations for preventing accidents valid in your Country. If the seal has been in operation with hazardous substances, the regulations for handling hazardous substances must be followed. In case of doubt, the necessary information has to be obtained before starting repair.

The order of disassembly to remove the mechanical seal out of the pump depends on the design of the pump and has to be determined by the pump manufacturer.

The disassembly (removal) of the seal has to be carried out in the reverse sequence as described for assembly (set up).

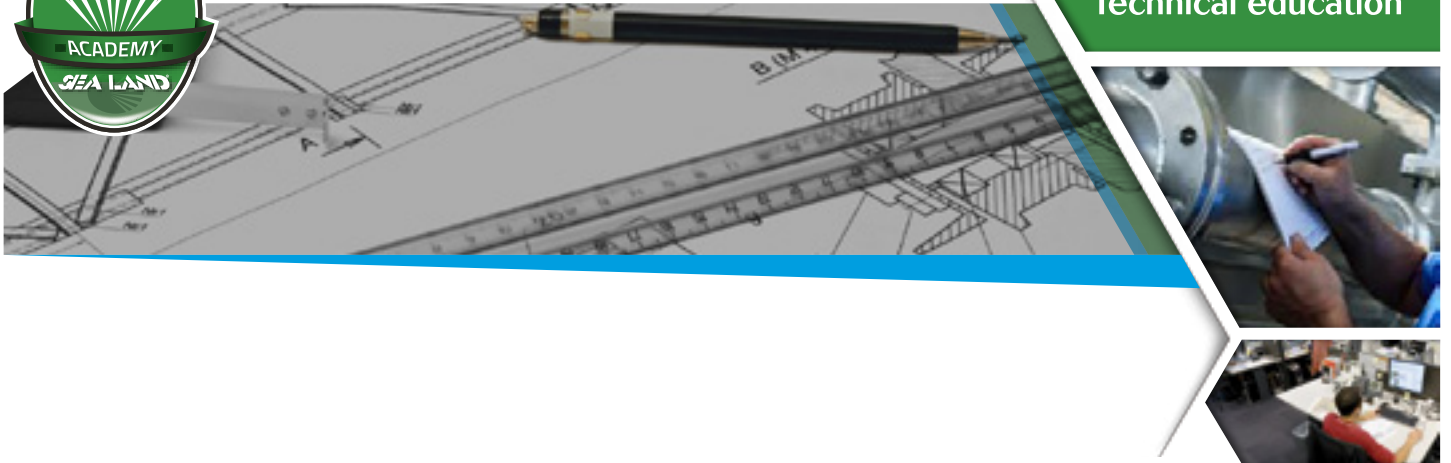

6.20 DISPOSAL INSTRUCTION

Usually, the EagleBurgmann BT mechanical seals can be easily disposed after a thorough cleaning.

- Metal parts divided into the different groups belong to scrap metal waste.
- Secondary seals materials (elastomers, PTFE) belong to special waste. Some of them, divided into the different groups, can be recycled. Attention: material containing fluorine must not be burnt. rials and
- Ceramic materials can be separated from their housing mate disposed as common waste.



Innovation
and
Technical education



7. TECHNICAL ASSISTANCE AND INFORMATION

For information please contact us:

Sea-Land S.r.l.
Via E. Mattei n.25
35038 Torreglia - Padova (Italy)
Tel. +39 049 5212944
E-mail: info@sea-land.it
www.sea-land.it

or

EagleBurgmann BT S.p.A.
Via A. Meucci n.58
36057 Arcugnano – Vicenza (Italy)
Tel. +39 0444 288 977
E-mail: info@eagleburgmannbt.com
www.eagleburgmannbt.com



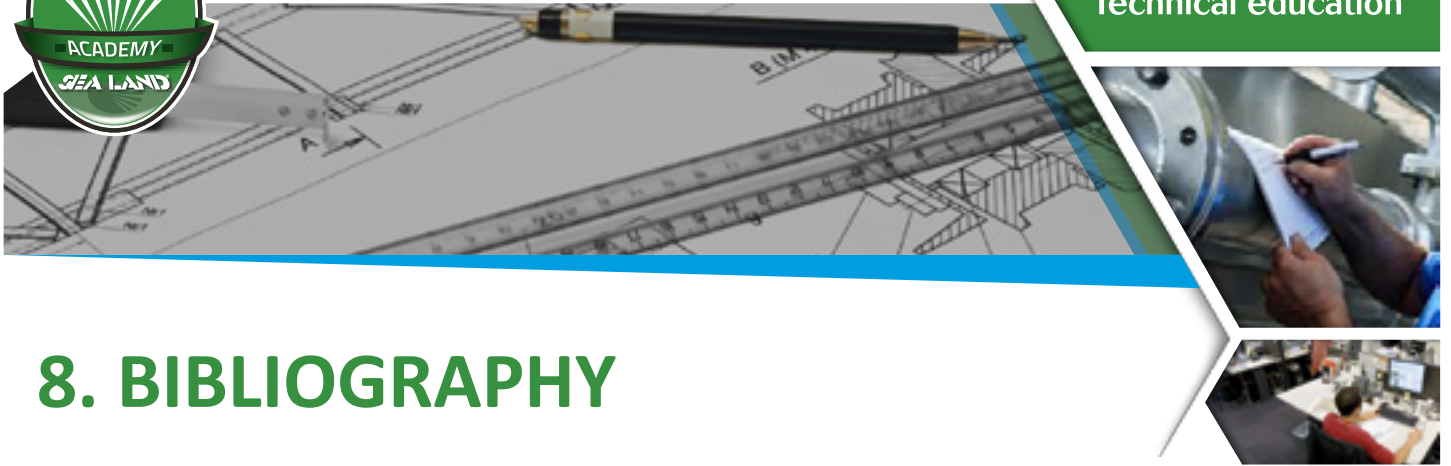

8. BIBLIOGRAPHY

- Summers-Smith J. D., Mechanical seal practice for improved performance
- Michael Huebner, Materials selections for mechanical seals
- Burgmann dictionary, The ABC of Mechanical Seals
- Busak+Shamban, O-ring manual
- Khairi Nagdi, Manuale della Gomma
- E. Mayer, Mechanical seals
- European standard EN 12756: Mechanical seals - Principal dimensions, designation and material codes
- Materials guideline for mechanical seals (seal faces and rubber parts) - EAGLEBURGMANN BT
- Operating manual for EAGLEBURGMANN BT mechanical seals
- EAGLEBURGMANN BT S.p.a. - Seal Materials