



MAINTENANCE MANUAL



Jain Irrigation Systems Ltd.
Jain Irrigation Systems Ltd.

Jain Plastic Park, P.O.Box: 72, N.H. No.6, Jalgaon - 425 001. (India)
Tel: 0257-2250011/22, Fax: 0257-2251111/22, Tlx: 0753-254 JISL IN, Cable: JAIN DRIP,
E-Mail: jisl@jains.com, Internet: www.jains.com



MOST IMPORTANT INSTRUCTIONS FOR THE FARMERS

1. During installation, the farmer should know in detail from dealer's representative or installation engineer about various parts of the system, their functions and maintenance.

2. Company's authorised dealer or his representative would visit the farmers twice in the first year and the farmer (user) should get all his doubts cleared, if any, during these visits. This is necessary because the farmer has to do the maintenance of the system by himself in future.

About the farmer who is not happy with his system and the one who is fully satisfied : The fundamental difference between these two is the ignorance of the basic idea underlying the system, various components, their functions and uses in a very broad manner.

For the one unhappy farmer, the story goes like this;

- Company people came, installed the system and that is all. I know nothing beyond that.
- It has to be automatic. Why maintain ?
- Drip irrigation done but no increase in the yield.
- Drip is not beneficial.

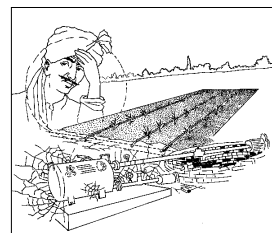

Whereas the one who is satisfied with his drip system says;

- I know the basics of the system.
- I know how to properly use & maintain it.
- I regularly treat it chemically.
- I regularly flushed main, submain, laterals, filters - sand & screen both.
- Having done these, I never had any problem & had very good harvest. The system is marvellous.

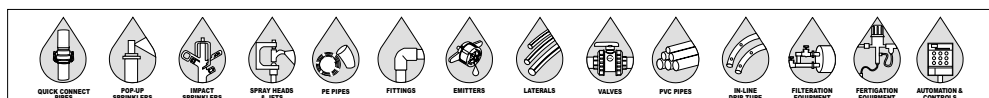
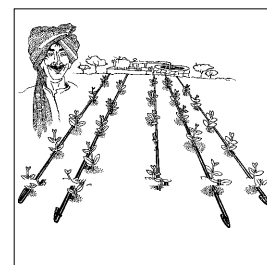
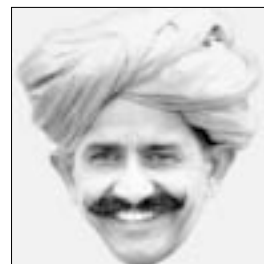



Chapter	Subject	Page
	THE GROUP	01
	FORWARD	02
1.	Micro(Drip) Irrigation Systems - Types & Advantages	03
2.	Components of Drip Irrigation System	06
3.	Water Requirements and Irrigation Scheduling	27
4.	Micro Irrigation Systems	
	a) Installation and Commissioning of Micro Irrigation System	32
	b) Operation and Maintenance of Filtration System	37
	c) Installation , Operation & Maintenance of Chemigation & Fertigation Equipment	44
5.	Maintenance of Micro Irrigation System	47
6.	Sprinkler Irrigation System	
	a) Working Principle	54
	b) Installation & Commissioning	55
	c) Trouble Shooting	56
7.	Trouble Shooting and Remedies	57
8.	Pumping System	60
9.	Consumer Advice	63
10.	Warranty Letter	64
11.	Post Installation	65
11.	After Sale Service	66
12.	A word of caution	70
13.	Advantages of MIS	71
	SPECIMEN ANNEXURES	
I)	Installation Report	72
II)	Warranty Letter	74
III)	Free Service Coupons	75
IV)	Jain Drip Fortnight Report	77
	SYSTEM APPROACH	79



INDEX

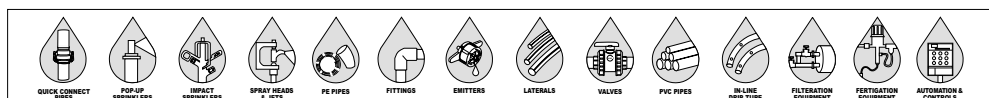



Started as a trading Company in 1963 by its first generation entrepreneur, Shri. Bhavarlalji Jain, Chairman, Jain Group, Jalgaon, it rapidly grew into a medium size multi national Company within a relatively short span through sheer dint of invincible determination and disciplined workculture . The group in the last 17 years achieved an annual turn over of Rs. 4000 millions (1997-99) mainly from its flagship Company namely Jain Irrigation Systems Ltd. of which export constituted Rs. 1000 millions. The group today is the largest processor of plastics in India annually processing 55,000 MT of different polymers into finished products predominantly used in agriculture & water supply apart from irrigation, industrial and construction use.

Jain Irrigation Systems Ltd., are pioneers and market leaders in Micro Irrigation Industry in the country today, having covered over 4.5 lac acres of land under Drip Irrigation covering over 45 different types of crops. The Company manufactures diverse ranges of micro irrigation system components and sprinkler irrigation systems suited for specific soil / water and agroclimatic conditions. In order to promote hi-tech agricultural activities, the Company diversified its activities into other hi-tech agro related forays like Tissue Cultured Plants, Green House Constructions, Water Soluble Solid / Liquid Fertilizers, Bio-Pesticides & Bio-Fertilizers. The Company is also into manufacture of Solar Water Heating Systems for conservation of conventional energy, medium density Polyethylene for Gas Conduit apart from other wood substitute products like PVC Door / Window Profiles for building construction and PVC / Polycarbonate / Acrylic Sheets for various applications - all these in collaborations or joint ventures with world leaders in related fields.

The Company, today is totally equipped to develop, virtually from concept to commissioning micro irrigation projects on any type and size of land anywhere within the country or abroad. All jobs are taken up on turn key basis, completed and handed over on a time bound schedule.

Jain Irrigation Systems Ltd., as the second largest manufacturer and exporter of Papain in the world and number one manufacturer and supplier of PVC Pipes in India is also the only established manufacturer / exporter of innovative Casing and Screen Pipes. In their latest diversification, a food processing plant - the largest in Asia with a capacity of 120 MT per day, the first phase of Dehydration of Onions and Vegetables Project and Fruit Processing Project is already gone on stream.

Jain Irrigation Systems in its Research and Development facility spanning over 1000 acres of land - the only one R & D farm recognized by the Government of India in the private sector for agriculture related activities, experiments on various agronomic and irrigation practices in line with International paradigms is an ongoing process.

In recognition of their outstanding R&D efforts in the field of agriculture, water management and its contribution to the farm and farmer, the Company has been honoured with several prestigious national and international awards for their outstanding contribution in this field. The latest is the honour conferred on the chairman by Irrigation Association of USA by bestowing the CRAWFORD REID MEMORIAL AWARD for "his significant achievements in promoting proper irrigation techniques and fostering major advancements in the industry outside the United States".

The Group's contribution in export thrust has been equally commendable. The Group is into export activities into all the six continents covering over 30 countries all over the world. New markets are being explored for increasing the export performance and earning FOREX from hard currency areas. In recognition of their export activities, they have been honoured with several export promotion awards by the Government of India year after year.

In order to compete with the international market in terms of quality, the Sheet Division, Pipe / Tube Manufacturing Division & Papain Division of Jain Irrigation System have got accreditation of ISO 9001 from RWTUV, Germany. Similar process is on for covering most of the products under this world standard.

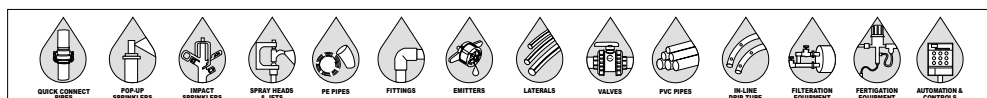



FORWARD

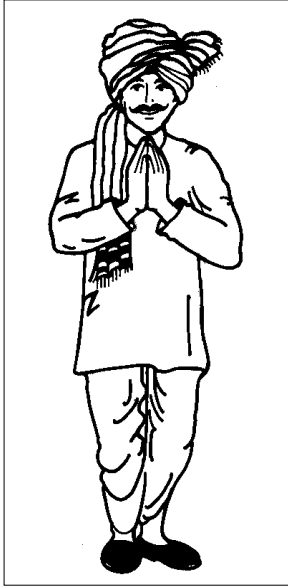

Dear Customer,

We congratulate you for installing our drip / drip tape irrigation system and becoming our valued customer. By doing so you have become the member of a large family of progressive farmers who have installed our systems and are getting their benefits.

Drip irrigation in the recent years is becoming quite popular not only due to water scarcity but also because people are convinced about the increased yields, quality products, labour savings, fertilizer savings, best use of problematic soils, saline water and undulated or difficult terrains.

Throughout India, drip irrigation is making big strides. We being one of the pioneers, put our best efforts to offer better quality products, efficient marketing and technically perfect but still economical installations of our drip systems.

Drip irrigation though not difficult compared to other irrigation systems, requires careful attention and proper maintenance. When one is benefitting so much from drip irrigation, stringent adherence to a few guidelines is the minimum needed to ensure.

Problems have been encountered in the field, when users have not been imparted with thorough knowledge of the system and as a result, there have been gaps in proper operations and maintenance. The detailed explanations about each and every aspect of Jain drip system are provided here to guide them.

Hope you would find it adequately informative and useful in the day to day operations of your drip/drip tape irrigation system.

Best wishes.

Yours sincerely,

Managing Director

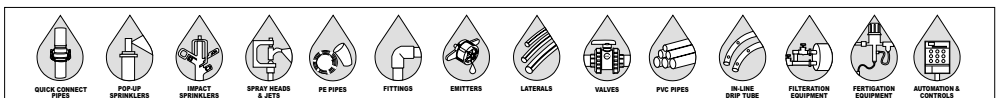



What is Micro/Drip Irrigation ?

Micro / Drip Irrigation is described as a regulated and slow application of irrigation water through emitters or orifices at frequent intervals near the rootzone of plant over a long period of time.

Principles of Micro/Drip Irrigation

Micro / Drip irrigation is the term used to describe the method of irrigation which is characterised by the following features :

1. Water is applied at a low rate.
2. Water is applied over a long period of time.
3. Water is applied at frequent intervals.
4. Water is applied via a low pressure delivery system.

Types of Micro Irrigation Systems

1. Emitter/Dripper Systems

Emitter systems are widely used in orchards, vineyards, landscaping and nurseries. Emitters or drippers are installed at predetermined spacing **on laterals** of various diameters.



Dripper System

2. Turboline (Integral Drip Line)

Emitting pipe with **Integral Drippers** spaced at different spacing according to customers demand. Turboline is very effective for the row crops like Cotton, Sugarcane, Vegetables and floriculture.



Turboline

3. Line Source Tubing (Jain Drip Tape)

This is an inexpensive plastic hose with **built-in orifices** spaced along its length. Drip tubing is an example of strip tubing. Tubing produces a continuous wetted strip and is widely used for row crops such as sugarcane, tomatoes, strawberries, vegetables, cotton etc.

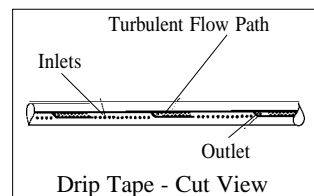

Drip Tape - Cut View

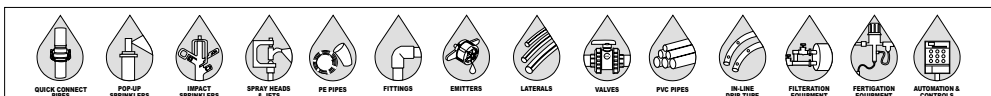



CHAPTER - 1 MICRO (DRIP) IRRIGATION SYSTEMS : TYPES AND ADVANTAGES

The flow is hydraulically turbulent in nature, precisely calculated and controlled.' Drip tape applies water slowly and right into effective root zone. Thus there is no runoff, evaporation loss.

4. Micro Jets

Jets operate at **low pressures** than sprinkler and generally apply water at **higher rates** than emitters. Additionally, jets wet a larger surface area than strip tubing or emitters because the water is sprayed through the air, in either a fan shaped spray or a number of discrete jets. However, because jets possess no moving parts, there is a limit to their distance of throw. Examples of jets are the full and half circle micro jets. These are useful for tree crops in light sandy soils.



Half Circle Jet Full Circle Jet

5. Micro / Mini Sprinklers

These, like jets, operate at low pressures, Micro-sprinklers incorporate moving parts which enable them to discharge the water over a **larger area** than jets. These sprinklers are available with different discharges and diameters of coverage. These are useful for **high discharge** requirement incase of old orchards and trees where dripper systems become uneconomical and also where crop canopy as well as the root spread is more.



Micro / Mini Sprinkler

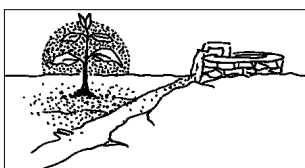

Conventional Irrigation System

Advantages of Micro / Drip Irrigation

Jain Drip Systems are designed to provide greater operational ease, highest functional efficiency and minimum maintenance. Following are the major advantages, which have justified the faith of thousands of farmers in the country.

1. Increased Yields : The system facilitates water application at regular interval thereby maintaining optimum moisture level at the rootzone for a longer period thus preventing moisture stress or shock associated with other methods of irrigation. This promotes optimum plant performance resulting in higher yield & better quality produce.

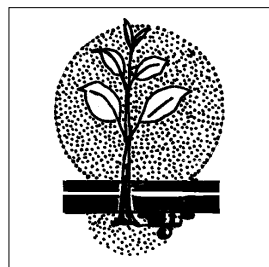

Micro / Drip Irrigation System

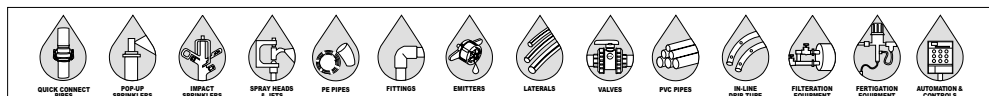



CHAPTER - 1 MICRO (DRIP) IRRIGATION SYSTEMS : TYPES AND ADVANTAGES

Almost all crops have responded well and resulted in an yield increase upto 100%

2. Improved Quality and Early Maturity : Crop Quality improvement and early maturity is a result of even growth and ripening, as explained earlier. In addition to this benefit, damage and losses due to water contact with fruit or foliage are eliminated.

3. Water Saving : Water saving experienced upto 70% in various crops as all percolation & evaporation losses are eliminated.

4. Controls weed growth, saving on fertilizers and labour costs : Water is applied directly in the root zone, wetting only a fraction of the soil; interspace between the row of plants is not allowed to go beyond the root zone. Saving in fertilizer use upto 50% has been effected.

5. Provision of application of fertilizer and chemical through the System : Jain Drip Systems comprise of a chemical application device to enable application of soluble fertilizers, systemic plant protection chemical and soil application-insecticides through the system.

6. Improved disease control : Disease control is enhanced under micro irrigation system, because the soil moisture and chemical additive levels can be closely controlled. In addition, spread of any disease organism by wetting the leaf and surface water runoff movement is eliminated.

7. Ideally suited for difficult terrain and problematic soils & water : Drip irrigation can convert a vast area of waste land into productive purpose. And at the same time eliminates the need of land levelling and removal of productive top soil. Drip irrigation can be used on saline soil even with brackish water.

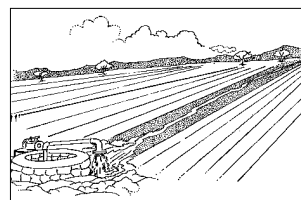

With Micro/Drip Irrigation, 2.5 acre can be irrigated with same quantity of water

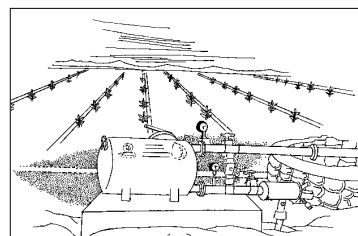

Conventional Method: It Can Irrigate only one acre with available water

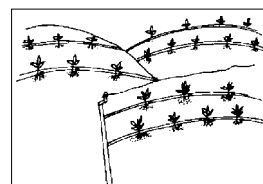

Micro Irrigation is a boon for Irrigation of undulating terrains

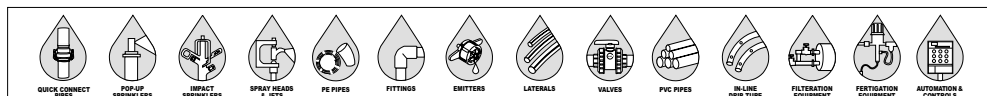



CHAPTER - 2 COMPONENTS OF DRIP IRRIGATION SYSTEMS

Fig. 2.1 shows the schematic drawing of basic components of Jain Drip/Drip tape system. The components of the system are as follows :

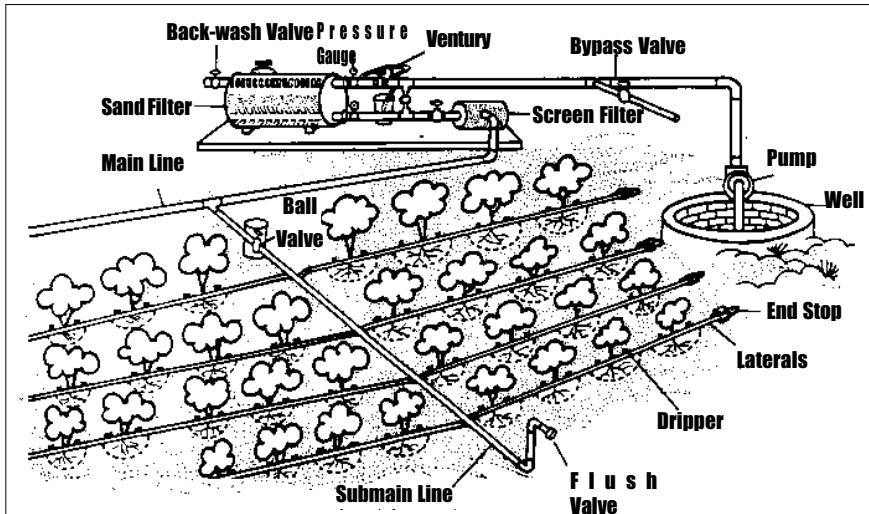

Fig. 2.1: Layout Diagram of Micro/Drip Irrigation System

1. Water Source :

The source of water can be wells, tube wells, canals, river, reservoir etc.

2. Pump :

The water from the source has to be supplied under appropriate pressure and discharge. This is usually achieved by selecting a right kind of pump.



Sand filter

3. Sand filter :

In drip irrigation system, drippers or drip tape tubes consisting of small holes are being used. If foreign particles, leaves, algae etc. coming with water are not filtered, they will clog the dripper and drip tape holes resulting in obstructing the water supply to the plants.

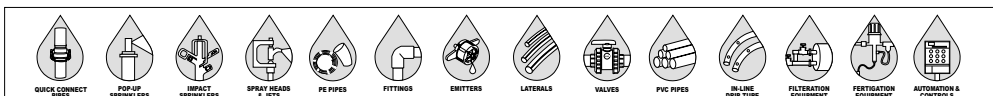



CHAPTER - 2 COMPONENTS OF DRIP IRRIGATION SYSTEMS

To prevent this problem, sand filter is connected with the main line. It stops impurities and allows only clean water to go ahead in main line, thus preventing clogging of the system.

4. Screen filter :

While majority of impurities are filtered by sand filter, minute sand particles and other small impurities pass through sand filter. They are filtered by screen filter, containing screen strainer which filters physical impurities and allows only clean water to enter in the system.

5. Pressure Gauge :

Maintaining the normal operating pressure in the system is essential to ensure uniformity of irrigation. Pressure gauge is provided at the filtration unit of Jain Drip System to indicate this pressure.

Specially developed three way valve arrangement is used to measure the pressure (inlet and outlet) and the gauge is protected against jerks, pressure surge and vibrations.

6. Ventury / Fertiliser tank / Fertigation Pump:

With the help of these equipments liquid/water soluble fertilizers can be given in to the rootzone directly by injecting the solution with the irrigation water. This results in full development of roots and crop & prevents wastage of costly fertilizers. These are is also used in acid treatment and chlorination, to clean the drip system & to apply other chemicals.



Sand Filter



Super -Flow Plastic Filter



Metal Screen Filter



Pressure Gauge



Ventury

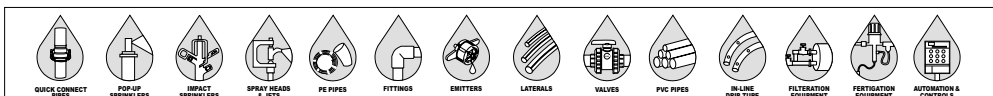



CHAPTER - 2 COMPONENTS OF DRIP IRRIGATION SYSTEMS

7. Valves :



PVC Valves

Jain drip system is provided with different types of valves. To control the water pressure, bypass valve is provided before filter. Gate valve is provided to create the pressure difference for the chemigation and fertigation. At the inlet of submain, control valve (ball valve) is provided and at the end of submain, a flush valve is fitted to facilitate regular cleaning of main and submains. Air release valve is installed at the highest point on the mainline to release the entrapped air during start of the system and to break the vacuum during shut off. It is also provided at the inlet of drip tape submain.

8. Main Line :



PVC Pipes

This is PVC/POLYETHYLENE Pipe line used to carry water from water source to submain. Filter is attached with this pipe so as to provide filtered water to submain.

9. Submain Line :



PE Pipes

Submain is also a PVC/POLYETHYLENE pipe line that supplies water to the laterals on one or both sides of it. Submains are buried at 1-1/2 feet in the soil to enable cultivation operations in the field.

Submains are provided with Ball valves so as to maintain required pressure and flow in the pipe. At its tail end, flush valve is provided for cleaning of main and submains.

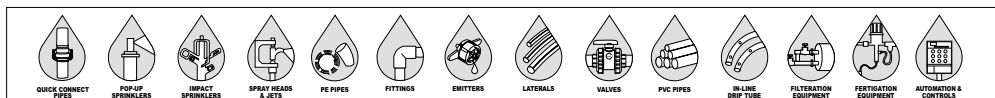



COMPONENTS OF DRIP IRRIGATION SYSTEMS

CHAPTER - 2

10. Poly Fittings :

These fittings are used for installing the lateral on submain, connecting the laterals & inter connection between lateral & tape or Turboline, Tee, Elbow, Joiner, Adapter, Take off End Plug & End Stops are available in 4 - 16 mm size.



Poly Fittings

11. Laterals/Drip tape :

These are either line source tubing or drip laterals and are made up of LLDPE which is quite flexible and strong. These convey water from submain lines to rootzone via drippers. They are spread in open field & their spacing is decided on the basis of row to row distance of the crop.

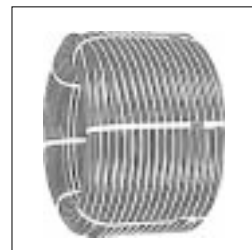

Laterals/Drip tape

12. Drippers :

Water coming from the laterals reaches the plant root zone through drippers. Type of crop, soil and crop water requirements are deciding factors for dripper spacing on the lateral. Drippers may be pressure compensating or non pressure compensating depending upon field topography. Some Drippers are openable to allow cleaning.

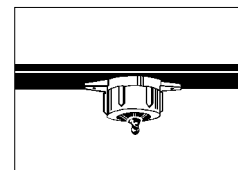

Dripper System

TurboPlus, J-Flow & J-Loc Drippers are available with extension barb to connect the Tube for pot Irrigation.

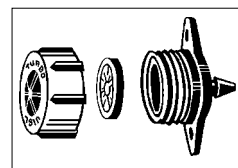

Disc inside the Dripper



Turboplus



J-Flow



J-Loc

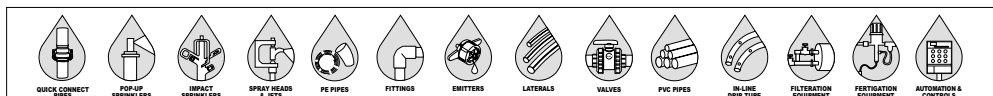



CHAPTER - 2 COMPONENTS OF DRIP IRRIGATION SYSTEMS

JAIN TURBOLINE

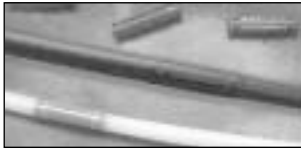

Turbo Line (Tube)

Jain turboline is an emitting pipe with drippers integrated in the lateral itself. The drippers are integrated inside the lateral at desired spacing. This system can be efficiently used in row crops including vegetables, melons, sugarcane etc.

Features of Jain Turboline

- 1 True tortuous path for fully turbulent flow.
- 2 Made from the high quality linear low density polyethylene material.
- 3 Drippers are inserted in the lateral line at desired spacing.
- 4 Maximum resistance to blockage.
- 5 Easy to reelout during non-application days.
- 6 Versatile; suitable for surface or subsurface installation.

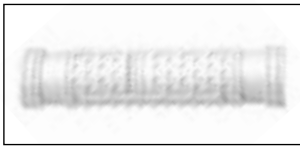

Dripper

AUTOMATION

Automation of an irrigation system refers to operation of the system with no or minimum manual intervention. The introduction of automation into irrigation system has increased application efficiency and drastically reduced labour requirement.

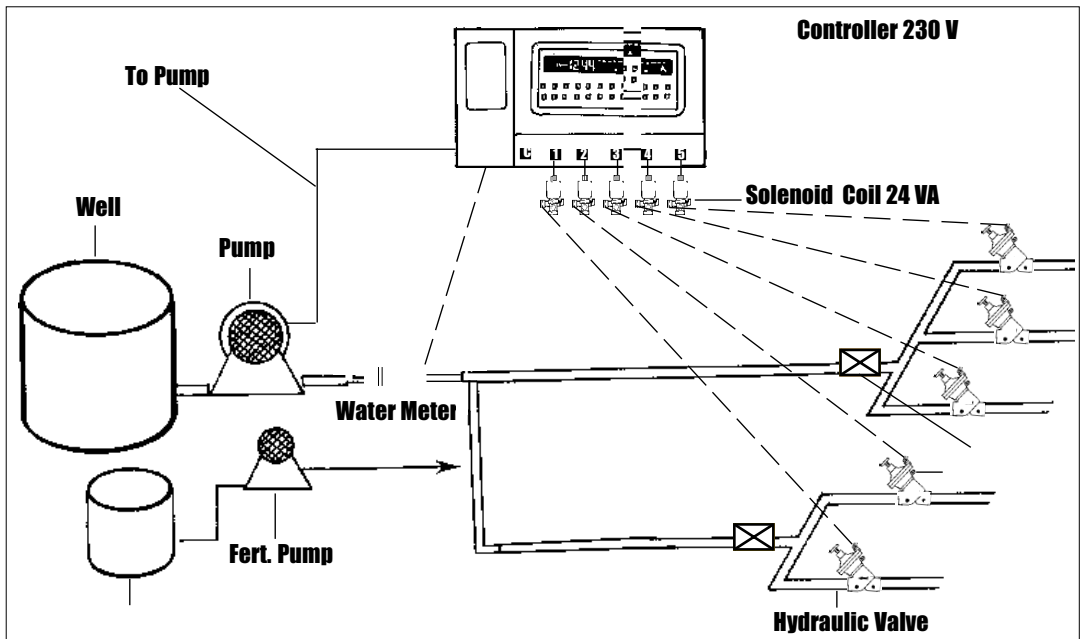

Schematic Layout of Automation

Various types of automation are possible. Some of them are,

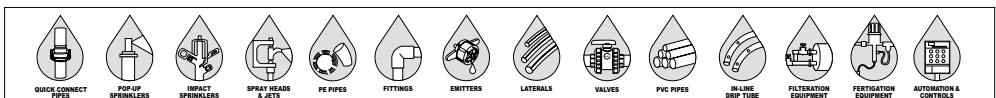



CHAPTER - 2 COMPONENTS OF DRIP IRRIGATION SYSTEMS

- (a) Time based system
- (b) Quantity based system
- (c) Moisture sensor based system

Total area to be irrigated is divided into small segments called irrigation blocks or zones and these zones are irrigated in sequence according to the flow of water available from the water source.

In time based system, time is a basis of irrigation. Time of operation is calculated according to volume of water required and the average flow rate of water.

In volume based system, the preset amount of water can be applied in the field segments by using automatic volume controlled metering valves. Sequencing of metering valves can also be done automatically.

The moisture sensing system is the extension of time based system. Operation of irrigation valves are controlled by the moisture sensors placed directly in to the root zone.



Tensiometer

BENEFITS OF AUTOMATION :-

- 1) Control over the entire irrigation system - Increased yield due to production factors.
- 2) Conservation of water, labour and energy - No need for manual operation to open and close valves, especially in intensive irrigation processes.
- 3) Flexibility - Possibility to change frequency of the irrigation and fertilization processes and also to optimise these processes.
- 4) Precision and Ease in Operation - Precision in providing water-fertilizers proportions; usually the operator is busy with other tasks and therefore misses his time schedule.
- 5) Adoption of advanced crop systems and new technologies especially new crop systems that are complex and difficult to operate manually
- 6) Use of water from different sources and increased efficiency of water and fertilizer use.
- 7) System can be operated at night, thus all day can be utilized for other agricultural practices.

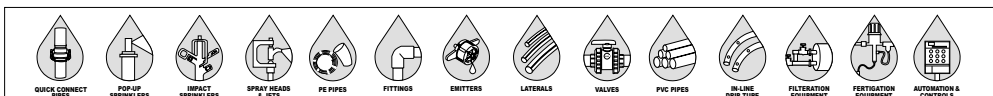



CHAPTER - 2 COMPONENTS OF DRIP IRRIGATION SYSTEMS

AUTOMATION EQUIPMENTS AND THEIR APPLICATIONS :-

Main components of an Automatic Irrigation System are,

A) CONTROLLER

This device is the heart of the automation, which coordinates operation of the entire system. The controller is programmed to run various zones of an area for their required duration. In some cases moisture sensors are used with it which gives feed back to the controller about field moisture level.



Controller

The controller has in built 24 - hr clock. There is an option to have different irrigation schedule for different days of the week. These are mostly multistation controller i.e. they can control 4/6/8/12 and even more number of solenoid valves through them. Other facilities available with the controllers are,

- Multiprogramme facility to suit different weather conditions.
- Weekly /fortnightly calendar or skip days interval option.
- Option to connect moisture sensors, temperature sensors, or other sensors having analog output..

B) CONTROL VALVES

Replacement of conventional manual valve by either solenoid valve or hydraulic valve is necessary for automation.

Hydraulic valves :-

These valves are operated on hydraulic pressure. The operation of a hydraulic valve depends on the type of valve and whether it is NC (Normally closed) or NO (Normally open) in principle.

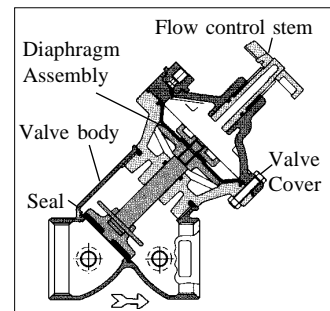

Hydraulic Valve

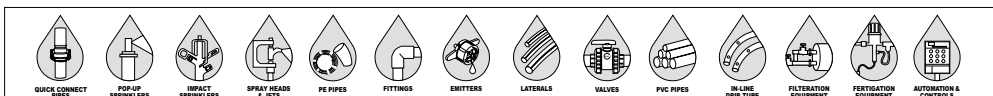



CHAPTER - 2 COMPONENTS OF DRIP IRRIGATION SYSTEMS

A command can be transmitted to these hydraulic valves by means of control tubes and solenoid coil. These solenoid coils are mounted on the main line and connected to the valve by control tubing.

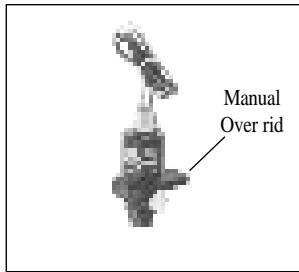

Solenoid Coil

C) SOLENOID COIL :-

Solenoid coil is used to translate electric pulses into hydraulic pulses which enable opening and closing of specific hydraulic valves. These solenoid coil requires 24 V AC input for its operation. Solenoid coil when mounted on the valve are connected to controller by electrical cable. The size of the cable is the function of the distance between solenoid valve and the controller.



Automatic Metering Valve

D) AUTOMATIC METERING VALVES :-

These valves are used in quantity based system. The volume of water required for the irrigation can be adjusted in these automatic metering valves. It shuts itself off after a preset quantity of water has flown through.

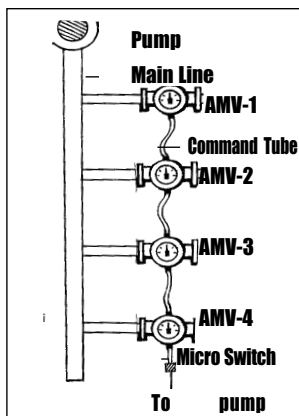

Sequential Arrangement of AMV

The sequential arrangements of these valves in the system is also possible. All automatic metering valves are interconnected in series with the help of control tube. During the sequential operation next valve in the series opens after the first valve closes. Shut down of the irrigation pump can be made automatic after closure of the last valve in series by connecting to a microswitch.

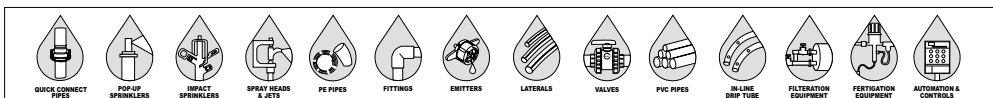



CHAPTER - 2 COMPONENTS OF DRIP IRRIGATION SYSTEMS

E) MASTER RELAY :-

This relay controls function of pump whenever any of the solenoid valve is switched on, one pulse is sent to activate master relay which in turn starts the pump through pump starter.



PROGRAMMING SCHEDULE AND WORKING OF TIME BASED SYSTEM:-

The first step to programme the irrigation system is to determine the duration of irrigation required for each section. The duration of individual valves are fed in the controller along with the system start time. Clock of the controller is set with the current day and time.

As the clock of the controller synchronises with the start time of the programme, controller starts sending 24 V AC current to the first solenoid valve in the programme sequence through the wire and also the same current reaches the master relay to start the pump. The solenoid / hydraulic valve, thus activated, comes to open position. As soon as duration of valve no 1. is over the controller switches valve no.2 and soon the process repeated till all the valves are activated one after the other. When operation of the last valve is over, controller stops sending current to solenoid and master relay, the pump is switched off. The same process is repeated at the next run.

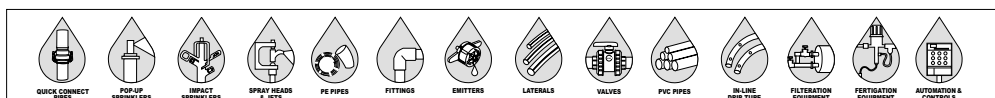



CHAPTER - 2 **COMPONENTS OF DRIP IRRIGATION SYSTEMS**

TROUBLE SHOOTING :-

PROBLEM	CAUSE	REMEDY
CONTROLLER		
1) Automation cycle does not begin at set start time and day.	Time & day set wrong Today is non watering day * Another cycle over laps so start can not occure. * Was running manually at time of start	Enter correct time and day Correct day schedule on today's day * Change start times * Do not run manually start time.
2) Zone display on but valve off.	* Fuse blown * No voltage to transformer * Broken wire to valve * Bad transformer * Bad valve	* Replace fuse. Do not install fuse with higher rating * Fix power to transformer * Fix wiring to valve * Replace transformer * Replace/repair valve
3) Zone(s) run when not expected	* Zone(s)running from other programme * Time & day set wrong & day.	* Set zone(s) in other programme. * Enter correct time
4) Display is off or has scrambled segments	* No batteries * Weak batteries * Corroded battery contacts	* Install batteries * Replace batteries * Clean battery contact and reset
5) Display is black	* Display is hot	* Let display cool

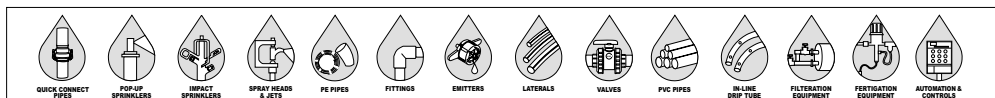



COMPONENTS OF DRIP IRRIGATION SYSTEMS

CHAPTER - 2

PROBLEM	CAUSE	REMEDY
VALVES Valve does not open	a) No water pressure b) Flow control closed c) Controller malfunction d) Faulty field wiring e) Faulty solenoid f) Plugged discharge path	* Check the water pressure. * Open the flow control * Check for power and programming error. * Check the voltage using multimeter it should read between 19 & 28 volts if not check and repair for faulty wire splices,cuts,under sized wiring. * Check resistance on multimeter. It should be between 20 & 60 ohms., a defective solenoid will read over this.Replace solenoid. * Disassemble and repair.

SOME USEFUL HINTS :-

In order to make the operation of your system smooth and trouble free here are some useful hints,

- 1) Install the controller at eye level this will facilitate easy programming and reading the screen.
- 2) Always equip voltage stabilizer to protect controller from voltage fluctuations.
- 3) Always earth your controller.
- 4) Use conduit pipes to carry the field wiring.
- 5) Avoid installing controllers in rooms where heat and moisture can be problem.
- 6) Protect the controller from water.
- 7) Protect the controller from insects, lizards, frogs and other reptiles.
- 8) Flow control stem are not meant for on/off operation but used for fine tuning the system by adjusting the pressure/flow.
- 9) As far as possible install the controller near to the water source or pump.

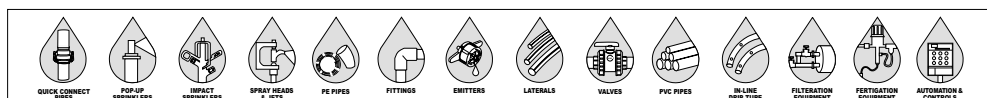



COMPONENTS OF DRIP IRRIGATION SYSTEMS

CHAPTER - 2

CHEMIGATION

Quality of water is the most important factor for the successful functioning of all kinds of drip systems. To prevent clogging, the measures such as filtration, flushing of laterals, submains and chemical treatments are needed, Drip system consists of large number of emission devices which have very small flow paths. These emission devices are prone to blockage due to contamination through water. Such contamination could be due to

1. Presence of large particles in water supply.
2. Presence of high silt and clay load in water supply.
3. Growth of bacteria slime in the system.
4. Growth of algae within the water supply and system.
5. Bacterial precipitation of iron or sulphur.
6. Chemical precipitation of iron.
7. Chemical precipitation of salts in laterals / drip tape and drippers.

PHYSICAL TREATMENT

Physical treatment of irrigation water is most common form of treatment. Such treatment includes use of hydrocyclone filters, sand filters and screen filters. These treatments are useful in removing large particles, clay or soil particles. Heavy loads of algae would quickly block up screen filters. Sand filters are very successful in filtration of algae.

CHEMICAL TREATMENT

Physical treatment will not remove bacteria or microscopic algae and these can grow within the system or can interact with particles of silt and clay and form clusters or

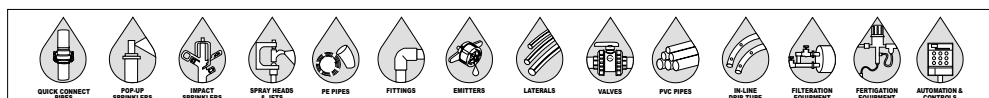



COMPONENTS OF DRIP IRRIGATION SYSTEMS

CHAPTER - 2

can catalyse precipitation of salts. Therefore chemical treatment of water either at the source or within the system is the most useful method of preventing or curing such problems. The treatment generally involves use of chlorine or acid intermittently or continuously.

Acidification of Drip Irrigation System

The injection of acid into drip irrigation system is primarily carried out to :

1. Lower the pH of the irrigation water and
2. Prevent the precipitation of salts.

Precipitation of salts such as calcium carbonate, magnesium carbonate or ferric (iron) oxide can cause either partial or complete blockage of the Drip Systems. Acid may also be used to lower the pH of the water in conjunction with the use of chlorine injection to improve the effectiveness of the chlorine as a biocide. Acid may also be effective in cleaning systems which are already partially blocked with precipitates of salts.

The most reliable step for deciding on acid treatment is a water analysis. Soil and water samples are collected during the survey and then analysed to recommend acid or chlorine treatments as per the water quality. Ventury, Fertilizer pump or Fertilizer Tank is used for chemigation & fertigation.

CHLORINE INJECTION

1. Chlorine may be injected as continuous or intermittent treatment. Either type of injection is effective.
2. It is very important to treat the system regularly to prevent blockage.
3. Frequency of treatment depends on the level of contaminants in the water.

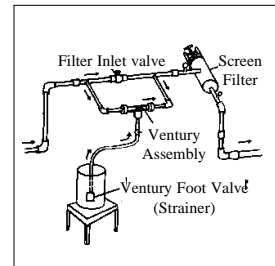

Ventury Installation



Fertilizer Tank

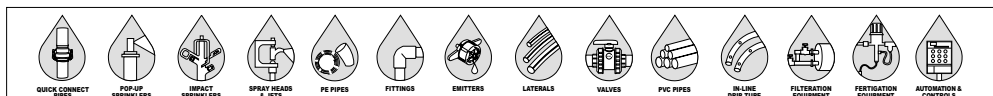



COMPONENTS OF DRIP IRRIGATION SYSTEMS

CHAPTER - 2

4. System should be chlorinated at the time of shut down and prior to use in the next season to keep lateral / drip tape lines sterilized

A. Continuous treatment:

Chlorine is injected continuously at a level sufficient to maintain the residual free chlorine at the end of the system (i.e. 10 to 20 mg/lit)

B. Intermittent Treatment:

i. The quantity of chlorine depends on the amount of organic matter present in the water.

ii. Chlorine is absorbed in killing micro organism, hence larger amount is injected at the start to maintain the required level at the ends of lateral/drip tape.

iii. Treatment on a 15 day cycle with chlorine injection at the end of irrigation is a good a practice.

If no organic matter is built up, this period can be extended.

C. Super - Chlorination:

When a system is partially or completely blocked with organic material, it is possible to clean the system by super chlorination i.e. injecting chlorine at a rate of 500 mg/litre for a time sufficient to ensure even distribution through out the lateral.

Common Chlorine source.

Calcium Hypochlorite (Bleaching powder): It is available commercially in a dry form as a powder or as granules. Also known as "Bleaching Powder" and contains 65% freely available chlorine.

A known weight of bleaching powder can be added to the measured quantity of water. It must be stirred vigorously to break the lumps.

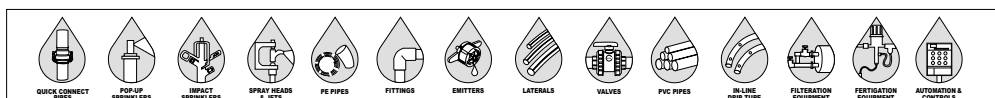



COMPONENTS OF DRIP IRRIGATION SYSTEMS

CHAPTER - 2

Recognition and Rectification of Problems:

Sr. Problem No.	Reasons & identification	Control
1. Precipitation of calcium and Magnesium salts	Appears as white film on the inside of the lateral /drip tape or in the flow path of drippers associated with increase in pH or decrease in temperature of water.	Continuous injection of acid to maintain pH of 6.0 - 6.5 sufficient to prevent formation of precipitation
2. Precipitation of Calcium Carbonate	While in solution there will be no problem But as soon as system stops and water evaporates calcium precipitates as white crystals around dripper/drip tape orifice and blocks the holes.	Continuous injection of acid to reduce pH of water upto 4.0 Repeated treatment for severe blockages.
3. Precipitation of iron	Changes in temperature and pH cause iron to oxidise to insoluble ferric form causing precipitation. Precipitation forms a red slime mass.	Acid treatment to lower the pH upto or less than 4 and then thorough flushing after 24 hours.
4. Precipitation of Manganese	Manganese can precipitate out as manganese oxide either by chemical or bacterial action and colour of deposit is dark brown or black.	Acid or intermittent Chlorine treatment.
5. Growth of algae within water supply	These need light to grow and hence are found in all surface storage ponds, wells and in slow moving water. Grow quickly and profusely to pose severe problems.	Effective control by adding copper sulphate to water depending upon its concentration which varies from 0.05 to 2 mg/litre.

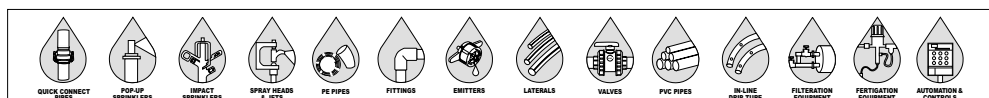



COMPONENTS OF DRIP IRRIGATION SYSTEMS

CHAPTER - 2

Sr. No.	Problem	Reasons & identification	Control
6.	Algae growth within the system	There are chances of algae growth within filters, on ground mains, submains lateral, drip tape & drippers.	Intermittent Chlorine injection
7.	Bacterial precipitation of Sulphur/Sulphides	Bacteria can produce sulphur if water contains more than 0.1 mg/litre of total sulphides. These bacteria produce White Cottony mass and completely block the emitting device.	Intermittent injection of chlorine.
8.	Bacterial precipitation of iron	With changes in temperature and pH some bacteria cause oxidation of iron to insoluble ferric form causing precipitation. It forms red colour slime and some what gritty slush.	Intermittent injection of chlorine.

Note:- Copper sulphate is very toxic to human beings and animals and hence due precaution should be taken to avoid drinking this water.

Procedure For Chemical Treatments

1. Water analysis report contains the recommendations for required quantity of acid or bleaching powder which is to be injected into the micro / drip irrigation system. **(Refer Table No. 1 for readily available quantity of acid or bleaching powder)**
2. Prepare the solution of acid or bleaching powder by referring the Water Analysis Report and **(Table no. 1).**

Example :- If water analysis report recommends the mixing of 50 ml of HCL with 100 Litres of water and 2" screen filter of capacity 25 m³/hr exists for the drip irrigation system; quantity of acid required will be 4.8 Litres. The volume of water required is $(20-4.8) = 15.20$ Litres. Prepare the solution of volume 20 Litres by adding 4.8 Litres of HCL in 15.20 Litres of water.

3. Connect the ventury tube to the mainfold of the filter as shown in the Fig. 6.1

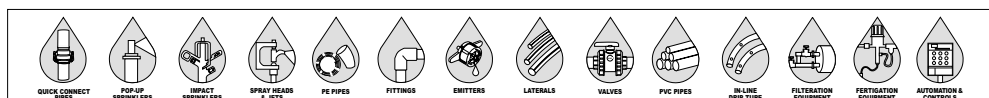



COMPONENTS OF DRIP IRRIGATION SYSTEMS

CHAPTER - 2

4. Immerse the suction pipe of ventury tube into the water.
5. Regulate the main valve of filter manifold gradually in such a way that the suction is created in the suction pipe of ventury.
6. Find out the minimum and maximum pressure and suction rate of ventury.
7. Fix the desired suction rate and pressure.
8. Pass the prepared solution through the ventury into the micro irrigation system.
9. Go to the last lateral and dripper of the irrigation system and check the pH in case of acid treatment or ppm in case of chlorine treatment with the help of pH or ppm paper.
10. Continue the acid or Chlorine treatment until you get the desired value i.e. pH = 4 for acid or ppm = 10 for Chlorine treatment.
11. After the treatment is over, shut off the system for 24 hours.
12. Flush out the whole irrigation system with water after 24 hours.

Precautions

1. Do not provide acid and Chlorine treatment at the same time.
2. Acid is harmful and it must be handled with care.
3. Never add water into acid, always add acid into water.
4. Ensure equipments used to handle the acid are resistant to corrosion.

Note:-

Acid and Bleaching powder can be purchased from our Regional Offices, authorised dealers and distributors.

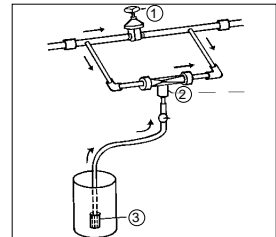
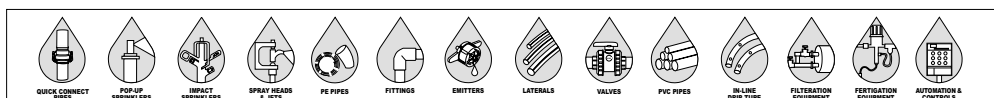
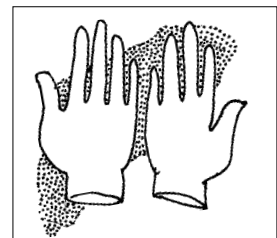

Fig. 6.1

1. Filter Inlet Valve
2. Ventury Assembly
3. Ventury Filter (Stainer)





COMPONENTS OF DRIP IRRIGATION SYSTEMS

CHAPTER - 2

Table 1 : Amount of HCL and Bleaching Powder for Acid Treatment and Chlorination

Amount of BP/HCL According to water Analysis Report	Amount of BP/HCL in 20 Litres Can		
	Screen Filter 2" 14 M3/Hr.	Screen Filter 2" 25 M3/Hr.	Screen Filter 3" 40 M3/Hr
Bleaching Powder (5.6 Gms. in 100 Lit. of water)	400 Gms.	770 Gms.	1150 Gms.
HCL (ml.) in 100 Lit. of water	Litres	Litres	Litres
10	0.50	1.00	1.40
20	1.00	1.90	2.90
30	1.50	2.90	4.30
40	2.00	3.90	5.70
50	2.50	4.80	7.10
60	3.00	5.80	8.60
70	3.50	6.70	10.00
80	4.00	7.70	11.40
90	4.50	8.70	12.90
100	5.00	9.60	14.30
110	5.50	10.60	15.70
120	6.00	11.60	17.10
130	6.50	12.50	18.60
140	7.00	13.50	20.00
150	7.50	14.50	21.40

BP : Bleaching Powder

HCL : Hydrochloric Acid

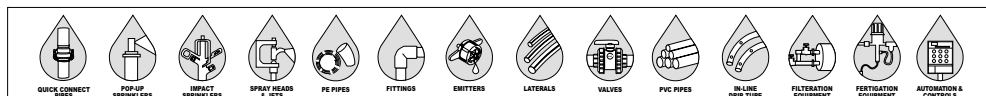



COMPONENTS OF DRIP IRRIGATION SYSTEMS

CHAPTER - 2



Loss of Fertilizers in conventional application

Fertigation

Fertilizers are normally used as basal dose or top dressing. The full year dose is split into 1, 2 or 3 doses. Because these fertilizers are applied in bulk, lot of fertilizers go waste due to leaching, evaporation and fixation in the soil. Moreover these fertilizers get transmitted to areas beyond the active root zone and are no longer useful to the plant. The effective utilisation by the plant is in many cases less than 50% of the fertilizers applied.

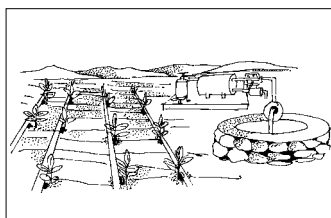

Efficient use of Liquid and water soluble fertilizers through Drip Irrigation

Drip irrigation which is the most efficient method of irrigation, has now been accepted and well established for horticultural crops, vegetables, flowers etc. The traditional fertilizers available in the market are not fully soluble in water and contain insoluble impurities and therefore these fertilizers cannot be applied through drip irrigation system.

We have now started production of liquid fertilizers as well as water soluble solid fertilizers. These fertilizers can be dissolved in water very easily and can be applied through drip irrigation system. This is called **Fertigation**.

Advantages of using liquid fertilizers :

1. Ensures a regular flow of both water and nutrients, resulting in increased growth rates and higher yields. Yield increase of more than 100% are possible to achieve with correct fertigation schedule.
2. Offers greater versatility in the timing of the nutrient application to meet specific crop demands.
3. Improves availability of nutrients and their uptake by the roots. The irrigation system is designed to supply both water and nutrients directly to the roots, creating a wetted zone at the site of the greatest root activity.



Fertilizer Injector Pump for efficient Fertigation

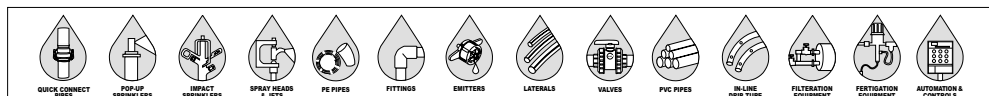



COMPONENTS OF DRIP IRRIGATION SYSTEMS

CHAPTER - 2

4. The fact that, three major nutrients are supplied in one solution to the plant gives better root absorptions and consequently higher yields.
5. Safer application method which eliminates the danger of scorching the plant's root system, since the fertilizer is greatly diluted in the irrigation water.
6. Offers simpler and more convenient application than any soil application of fertilizer, thus saving time, labour, equipment and energy.
7. Improves efficiency. The amount of fertilizer present in the soil at any time is small and therefore less susceptible to losses from leaching and runoff during heavy rainfall. This results in substantial savings in quantity of fertilizers (30% to 50%).
8. Allows crops to be grown on marginal lands, such as sandy or rocky soils, where accurate control of water and fertilizers in the plant's root environment is critical.
9. Since these fertilizers can be applied through drip using ventury or fertilizer tank or injection pump, the application becomes very simple and thus results in saving labour, & time.

Note: 1) Application of all the major nutrients by fertigation is same as explained in the chemical treatment procedure.

2) Use only 100% Water Soluble Fertilizer during fertigation through MIS. Don't use any other type of fertilizer.

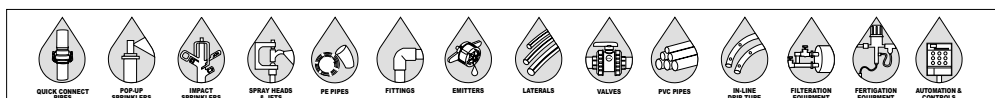



COMPONENTS OF DRIP IRRIGATION SYSTEMS

CHAPTER - 2

Liquid Fertilizer Grades

At present we are manufacturing liquid fertilizers of different grades with necessary micronutrients. These grades are as below



N	8	12	6	12	6
P	8	6	6	0	12
K	8	6	12	12	6

Water Soluble fertilizer Grades



Water Soluble Fertilizer

N	13	19	13	16	18
P	0	19	40	8	44
K	46	19	13	24	0

Dosage

Based on fertilizer requirement of each crop and soil condition, dosage of liquid & water soluble fertilizers are determined.

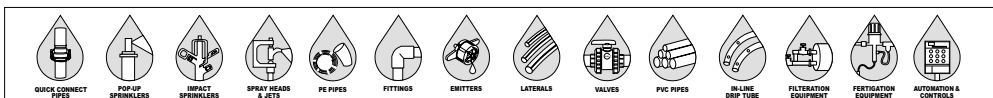



WATER REQUIREMENTS AND IRRIGATION SCHEDULING

CHAPTER - 3

Before calculating crop water requirements, following points are to be taken into consideration.

1. Type of crop and its age.
2. Type of soil.
3. Evaporation loss from the surface.
4. Transpiration loss from leaves.
5. Canopy area and rootzone development.
6. Plant to plant and row to row spacing.
7. Wind velocity, humidity etc.

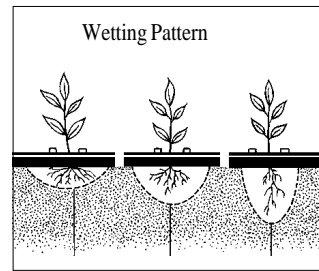

1. Heavy Soil
2. Medium Soil
3. Light Soil

After studying all above factors, the monthwise and agewise water requirement for the crop is decided and accordingly design is made.

As a first step in the proper design of the Irrigation System, it is necessary to know the crop water requirements. In general terms the crop water requirement is equivalent to the rate of evapotranspiration necessary to sustain optimum plant growth. The accuracy of the determination of crop water requirement will be largely dependent on the type of climatic data available.

Definitions :

Transpiration : It is the evaporation of water from plant surfaces directly into the atmosphere or into intercellular spaces and then by diffusion through the stomata to the atmosphere.

Evapotranspiration (ET_{crop}) : It is also called as consumptive use. It denotes the quantity of water transpired by plants during their growth or retained in the plant tissues plus the moisture evaporated from the surface of the soil and the vegetation.

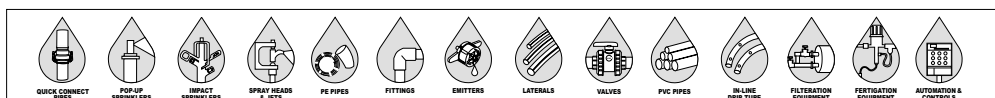



WATER REQUIREMENTS AND IRRIGATION SCHEDULING

CHAPTER - 3

Reference Crop Evapotranspiration (Eto) : Is defined as the rate of evapotranspiration from an extended surface of 8 to 15 cm tall green grass cover of uniform height, actively growing, completely shading the ground and not short of water.

The crop coefficient, Kc, is selected for given crop and stage of crop development under prevailing climatic condition.

1. Net Depth of Water : i.e. Evapotranspiration of crop (ETP)

$$ETP = Pe \times Pc \times Kc$$

Where Pe = Pan evaporation (mm)

Pc = Pan coefficient, taken as 0.7

Kc = crop factor. The value of crop factor depends on foliage characteristics, stage of growth, environment and geography. A crop factor 0.4 to 0.7 should be used for horticultural crops.

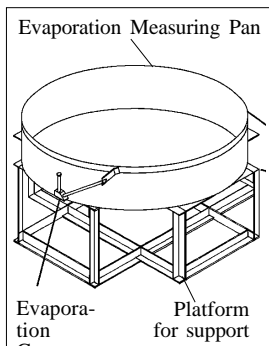

U.S. PAN-A. - Evaporimeter

2. Volume of Water for Tree Crops :

Total volume of water required (litre per day per tree) :

$$\text{Net depth of water} \times \% \text{ wetted area covered by foliage} \times \text{spacing between trees} \times \text{spacing between rows}$$

Wetted area is the area which is shaded due to its canopy cover when the sun is over head, which depends on the stage of crop growth.

3. Volume of Water for Row Crops :

Volume of water required

Per unit area per day = Net depth of x Kc x % wetted area water covered by foliage

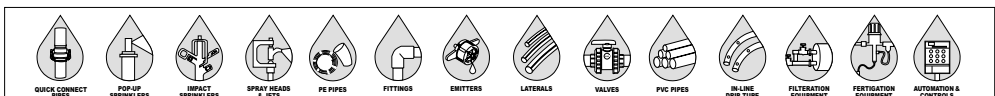



WATER REQUIREMENTS AND IRRIGATION SCHEDULING

CHAPTER - 3

Net depth of water can be assumed as 8 mm/day if data on evaporation rates are not available.

Example :

Water requirement per square meter for a row crop with crop coefficient 0.7 and % wetted area covered by foliage as 0.5 will be

$$\begin{aligned}\text{Water requirement (lit/sq.m)} &= 8 \times 0.7 \times 0.5 \\ &= 2.8 \text{ ltr/sq.m/day}\end{aligned}$$

Calculation of Irrigation Time

(Tree Crops)

$$\text{Irrigation time (hrs)} = \frac{\text{Water requirement litres/tree/day}}{\text{Application rate of water (litres/tree/hr)}}$$

Example : Water requirement for coconut = 100 lit/tree/day & if four drippers each of 4 lph discharge are provided per tree, then.

$$\text{Irrigation time} = \frac{100}{16} = 6.25 \text{ hrs.}$$

Calculation of Irrigation Time

(Row Crops)

$$\text{Irrigation time (hrs)} = \frac{\text{Water requirement per unit area per day}}{\text{Discharge rate per unit area}}$$

Discharge rate per unit area is calculated as lateral line discharge rate divided by row spacing.

Example : Drip tape discharge rate at 7 m operating pressure = 3.72 LPH per meter

$$\text{Tape to tape spacing} = 2.13 \text{ m}$$

$$\text{Discharge rate per unit area} = \frac{3.72}{2.13} = 1.74 \text{ lit/hr/Sq.m.}$$

$$\text{Irrigation time} = \frac{2.8}{1.74} = 1.61 \text{ hrs.}$$

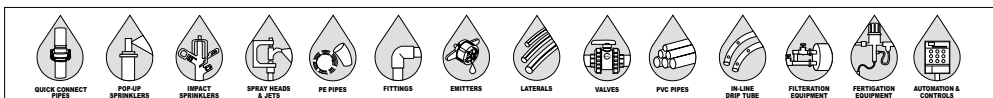



WATER REQUIREMENTS AND IRRIGATION SCHEDULING

CHAPTER - 3

General peak water requirements for different crops are given in the following table No.1 :-

Table - 1:

Sr. No.	Crop	Spacing (Ft X Ft)	Peak Water Requirement (Lit/Day/Plant)
01.	Grapes	6 x 4	10 - 12
		8 x 6	18 - 20
		8 x 8	24
		8 x 10	30
02.	Pomegranate	10 x 10	30 - 40
		12 x 12	40 - 50
		15 x 15	70 - 75
03.	Guava	15 x 15	70 - 80
		18 x 18	100 - 120
		25 x 25	120 - 130
04.	Sapota/Mango	25 x 25	120 - 140
		30 x 30	150 - 170
05.	Orange/Lemon/ Citrus	16 x 16	75
		18 x 18	85
06.	Custard apple	10 x 10	40
		12 x 12	50
07.	Ber	10 x 10	30
		12 x 12	55
08.	Banana	6 x 4	22
		6 x 6	25
		5 x 5	22
		3 x 6 x 5	25
09.	Papaya	5 x 4	16
		7 x 7	18
10.	Coconut	25 x 25	80
11.	Cardamom	10 x 10	15
12.	Rubber	15 x 15	24
13.	Oilpalm	30 x 23	150
14.	Sugarcane	Drip tape at 8 ft	20 lit/m/day
		Drip tape at 7 ft	18 lit/m/day
		Drip tape at 6 ft	16 lit/m/day
15.	Cotton/Groundnut	Drip tape at 6 ft	15 lit/m/day
16.	Vegetables/ mulberry/flowers	Drip tape at 6 ft	14 lit/m/day
		Drip tape at 5 ft	12 lit/m/day
17.	Tea/Coffee	Drip tape at 8 ft	15 lit/m/day
		Drip tape at 7 ft	13 lit/m/day

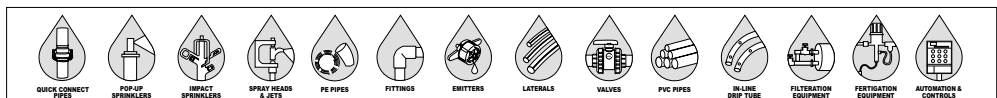



WATER REQUIREMENTS AND IRRIGATION SCHEDULING

CHAPTER - 3

NOTE :

Peak water requirements given in Table 1 are indicative and serve as a guideline. However, actual water requirements and irrigation scheduling should be decided by experience and observation of available soil moisture, crop growth and other climatological factors.

Crops such as Citrus, Custardapple, Pomegranate, Grapes Ber, Mango require to be subjected to moisture stress, as part of their cultural practices. In these instances, rate of application should be reduced gradually, under drip system too.

Sources :

1. Crop-water evaluation manual FAO-24
2. Localised Irrigation Book, FAO
3. Local Agril. University Publications

The interval between two irrigations depends upon the characteristics of soil texture, agroclimatic conditions, stage and age of crop. The irrigation intervals can be decided based on the following Table No.2.

Table-2 : Suggested irrigation intervals

Sr.	Climate	Very coarse Soil	Light sandy Soil	Loams and Clay soils
1	Hot and dry, (High transpiration rates)	Twice a day	1 or 2 days interval	2 or 3 days interval, thrice a week.
2	Moderate	Once a day	2 or 3 days intervals thrice a week	3 days twice a week
3	Cool, low transpiration rates	Once a day	Twice a week	4 days interval

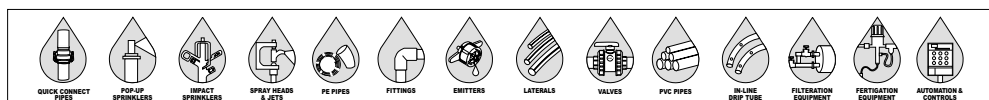



MICRO IRRIGATION SYSTEMS

CHAPTER - 4

A) INSTALLATION AND COMMISSIONING OF MICRO IRRIGATION SYSTEM

For the installation of Jain Drip System some basic data are required. These data are collected at the time of survey of the field and then system is designed on technical and commercial parameters.

Following are the various steps in installation of the system:

- 1) To collect information of farmer and farm.
- 2) To survey the field and preparation of rough drawing.
- 3) To collect and study the agro climatic data i.e. rainfall, temperature, evaporation, sunshine hours etc.
- 4) To collect the soil and water samples and analyse them in the laboratory.
- 5) To make recommendation for chemical treatments.
- 6) To fix the irrigation and fertigation schedule.
- 7) To study the inter-relationship between crop, water, soil and agro-climatic factors and accordingly selection of type of system is done.
- 8) To select the length and diameter of main and submain lines by keeping in view the discharge of well, existing pump capacity, existing pipe line (if any), and peak water requirements of the crop.
- 9) To suggest proper pump.
- 10) After studying all the above factors, final engineering design is prepared on computers.
- 11) After preparing the complete proposal with all technical details, short quotation including major items and assuming certain percentage of fitting and accessories, is submitted to the farmer which indicates ruling prices.
- 12) After receiving the confirmed orders with advance by demand draft or bank letter, required material according to the system design is sent to the farmer's field along with the bills.
- 13) Along with the materials, technical details of the system are provided to the farmer through a dossier. This dossier also contains soil and water analysis report, recommendations for



Survey



Water & Soil Analysis

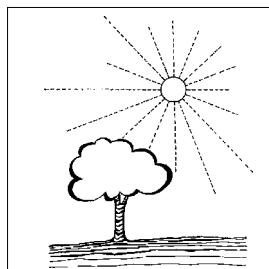

Interpretation of Climatological Data

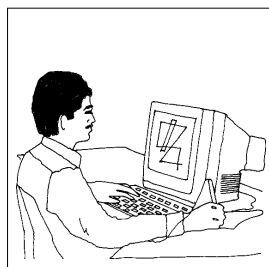

Computerised Design

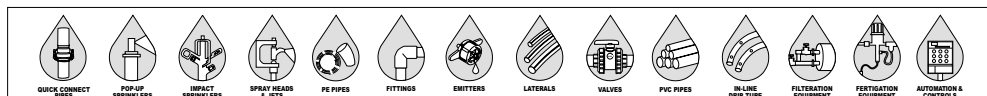



CHAPTER - 4 MICRO IRRIGATION SYSTEMS

A) INSTALLATION AND COMMISSIONING OF MICRO IRRIGATION SYSTEM

chemical treatments, according to water quality and month-wise, age-wise scheduling of irrigation.

14) On receipt of material at the farmer's field, company's / dealer's representative will help the farmers to ascertain that quantities are in order and as per the bill.

15) Company's / Dealer's representative will visit the field and mark as per the installation sketch i) the outline for trenching work to lay mains and submains. ii) the location for filters.

16) The farmer will ensure that the trenches are dug with minimum depth and width of 1.5 feet within the given time. If both the mains and submains run through one trench, it should be more in width.

17) Once the trenching is completed, installation team will be called. This team will help the farmer get acquainted with the system lay-out, components, their functions and operation in general.

18) Before any alteration to the system changing the system design, always consult the technical division of the Company or Authorised dealer as the system designed for one crop may not be adequate or suitable for another crop and / or spacing.

INSTALLATION of Jain Drip / Drip tape system can be divided into three stages.

- a) Fitting of filter station / control valves.
- b) Connecting mains and submains.
- c) Laying of drip tape or lateral with drippers.

A) Fittings of Filter Station :

1. For sand filter, a hard base or concrete base should be made. Size of the basement can be selected as per size of the filter e.g. for 1.5" sand filter, basement platform would be 5 x 3 feet, where as for 2" and 3" sand filter, it would be 6 x 4 feet and 6 x 5 feet respectively.

2. Once the sand / screen filters are installed in the correct position, arrangement of backwash and bypass are done according to farmer's convenience.



Sand Filter

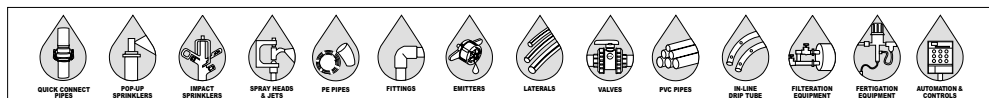



MICRO IRRIGATION SYSTEMS

CHAPTER - 4

A) INSTALLATION AND COMMISSIONING OF MICRO IRRIGATION SYSTEM

3. It is thoroughly checked and ensured that all the fittings are done properly.

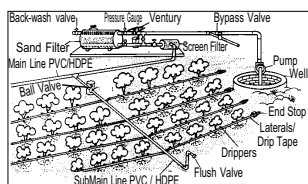

B) Mains & Submains Connections :

1. Mains and submains are PVC / HDPE pipe lines. PVC pipelines are laid underground at the depth of more than 1.5 feet so as to avoid damages during intercultivation.
2. First filter fitting is done and then main lines are connected starting from the filter, and followed by the submains as per installation sketch.
3. A ball valve is provided at the inlet of the submain. After the ball valve, an air release valve is provided on the drip tape submain.
4. A flush valve facing the slope of the submain is provided at the end of each submain to facilitate submain flushing.

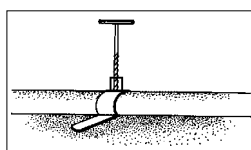

Submain Drill

C) Laying of Drip Tape or Lateral with Drippers :

1. Once the gromate take off's are fixed upon the submain, lateral / polytube laying is done as per the design. For this, holes are drilled on submain pipe, according to the size of gromate take off (GTO) i.e. ϕ 11.9mm drill for 8mm ID GTO & 16.5mm drill for 13mm ID GTO. Then gromates are fixed in it and on these takeoffs are fixed. Lateral is fixed to one end of take off.
2. Lateral placement is done according to row distance, with sufficient shrinking allowance and extra lateral provided at the end.
3. Then drippers are punched on the laterals as per the design.



For Drip Tape :

- 1) Drip tape should be laid straight. Its outlets should always face upwards.
- 2) Drip tape should be in between two crop rows and that too in the centre exactly. Otherwise, one row would receive more water and the another less.
- 3) For sugarcane, Drip Tape should be laid at the proper depth of 6-8 inches below surface according to the soil type and should always be covered with soil.

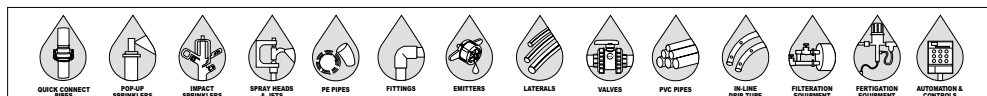
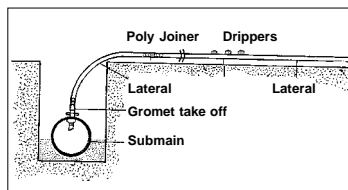



CHAPTER - 4 **MICRO IRRIGATION SYSTEMS**

A) INSTALLATION AND COMMISSIONING OF MICRO IRRIGATION SYSTEM

Commissioning :

After installation, the testing / commissioning should be done in the following way.

- 1) Backwash the sand filter for the removal of dirt, algae, organic matter etc. through backwash valve.
- 2) See that all the control valves and flush valves are open before testing.
- 3) Close the flush valve after the submain is completely flushed.
- 4) When drip tape/laterals are completely flushed, close their ends with the help of end caps.
- 5) Check the pressure on the gauges installed at the inlet and outlet of the filter.

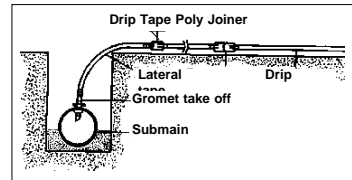

Jain Turboline

INSTALLATION :-

Proper installation of Jain turboline is important for efficient and trouble free operation. The following recommendations apply to the installation of Jain Turboline.

- 1 Jain Turboline may be laid on the surface or buried.
- 2 Jain Turbo line should be laid straight with emitter outlet placed near the root zone. To prevent the snaking of the lateral Jain lateral holding clip' is recommended. This will ensure application of water exactly at the root zone.
- 3 Take care during the installation to prevent soil, insects and other contaminants from getting in to the tubing.
- 4 An air/vacume relief valve should always be installed at the submain to prevent suction in the Jain Turboline, when the system is shut down. Otherwise suction in the Jain Turboline will tend to draw contaminants back into the tubing through the orifices, causing emitter clogging.
- 5 Air and vacuum relief valves are normally installed at high points of supply lines, mainlines and submains.
- 6 When applying fertilizers or chemicals through Jain Turboline, operate the system until all residual material has been flushed out.



Installation



Jain Air / Vacuum relief valve

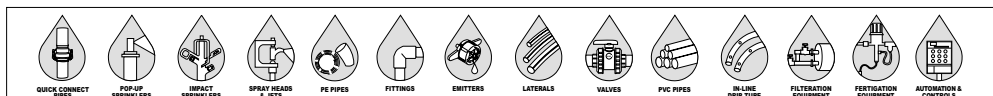



CHAPTER - 4 MICRO IRRIGATION SYSTEMS

A) INSTALLATION AND COMMISSIONING OF MICRO IRRIGATION SYSTEM

Ensure that pressure gauges both on the sand & screen filters are functioning properly.

During rain there is possibility that water might enter into the gauge and rust it. It is therefore wise to cover it with Polyethylene sheet or tin can, so that there would be no damage from shock and rain.

- Allow the water to flow into the system completely.
- After the system is completely filled with water read the pressure on the pressure gauge.
- For measuring the pressure at the submain, use pressure gauge adopter.
- Maintain the desired pressure at the filter- If excess pressure is observed, open the bypass valve slowly till the desired pressure is obtained.
- At this pressure, measure the discharge at minimum 25 different places. For this volumetric method can be used.
- Check the working of air release valve at the drip tape submain.
- After the entire fitting of the system, install ventury properly on the filter manifold.

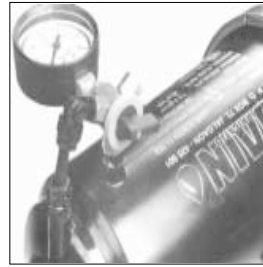

3 Way Valve arrangement

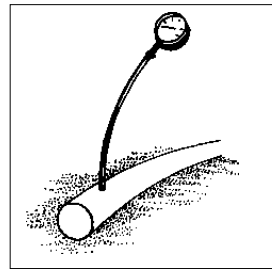

Use of Pressure Gauge Adopter

Our Representative Explaining the farmer about the Micro/Drip Irrigation System

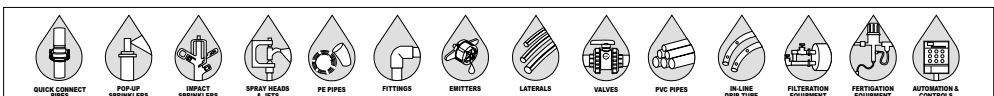



CHAPTER - 4 MICRO IRRIGATION SYSTEMS

B) OPERATION AND MAINTENANCE OF FILTRATION SYSTEM

Periodic preventive maintenance is very essential for the successful working of drip irrigation system. Following are the things to be done on daily, weekly and monthly basis, to ensure the proper working of the system.

General Maintenance

1. Check for lateral/drip tape functioning, wetting zone, leakages of pipes, valves, fittings etc.
2. Check the placement of drippers, incase the placement is disturbed. Put drippers to the proper location by moving the 6 mm extension polytube/Microtube and removing excessive snaking.
3. Check for leakages through filter gaskets in the lids, flush valves & fittings etc.

Filtration System :

In order to get maximum efficiency and optimum result it is necessary to prevent emitter, sprinkler and laterals from clogging. Hence, filtration system is the heart of irrigation systems. Properly maintained filters will ensure maximum efficiency of irrigation systems, by avoiding clogging.

Type of Filters :

1. Hydrocyclone Filters
2. Sand Filters
3. Screen Filters

These filters can be used individually or as combination depending on available water quality. Screen filter is also used as a control filter with sand filter.

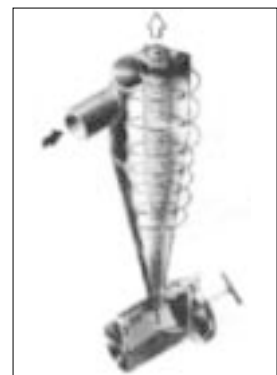

Hydrocyclone Filter
(Single Unit)

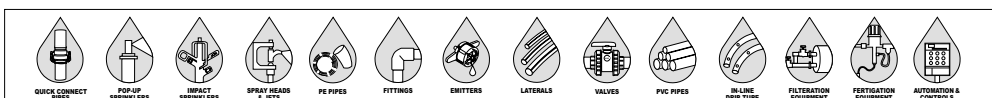



CHAPTER - 4 MICRO IRRIGATION SYSTEMS

B) OPERATION AND MAINTENANCE OF FILTRATION SYSTEM

1) Jain Hydrocyclone Filters :

The most efficient filter for filtering sand and heavy dirt.

How Hydrocyclone Works :

The hydrocyclone filter has been designed and built on the principle of free flow, according to which water flows freely in a spiral path along the length of filter cylinder. As a result of centrifugal force, particles become separated from the water and adhere to the filter walls. It then gravitates downwards; the purified water rises to emerge from top of the filter. Hydrocyclone filter should be installed before sand and screen filters.



Hydrocyclone Filter
(Multiple Unit)

Maintenance of Hydrocyclone Filters :

Hydrocyclone filter requires least maintenance by cleaning the dirt, inside the under flow chamber at daily interval. Flush the chamber by opening flush valve/cap or open the main valve, for thorough cleaning.

2) Jain Sand Filter :

Sand filter is effective for removing organic heavy and inorganic contaminates.

How Sand Filter Works :

Filter is provided with bed of silica sand for filtration; water enters through the inlet pipe and collects over the bed of sand. Water percolates through the minute pores; the contaminants get trapped/retained on top. Clean filtered water comes out through the outlet pipe.

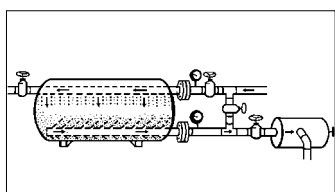

Sand Filter
(Normal Mode)

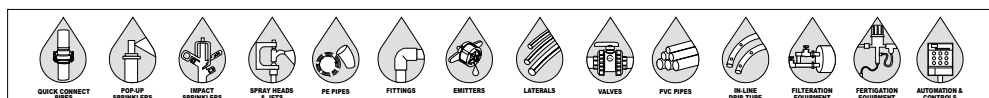



CHAPTER - 4 MICRO IRRIGATION SYSTEMS

B) OPERATION AND MAINTENANCE OF FILTRATION SYSTEM

Maintenance of Sand Filters :

Over a period, the contaminants in water accumulate and clog more space in the sand bed and thus reduce the efficiency of filter. Daily backwashing of your sand filter is very important. Backwashing is the processes in which water flow is reversed and sand bed is lifted and expanded allowing it to release the collected dirt. The dirt is then carried away through backwashing valve.

Backwash flow should be adjusted properly, because excessive backwash flow will lead to removal of sand itself out of the filter and insufficient backwash flow will not clean the sand properly. The sand filter should also be cleaned regularly as follows:

- 1) Open the lid of sand filter as illustrated.
- 2) Allow the water to come out through the lid (flow should be such that no sand comes out.)
- 3) Stir the sand thoroughly by moving the hand in between the black filter candles without disturbing their positions.

Sand filters are available in three types of back wash options:

- A) Manual
- B) Semi Automatic
- C) Fully Automatic

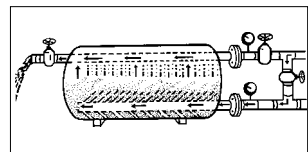

Sand Filter Backwash Mode

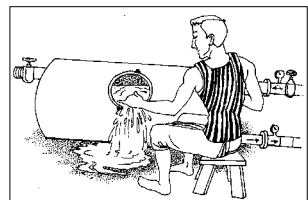

Sand Filter (Cleaning)

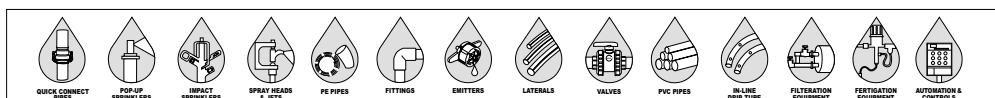



CHAPTER - 4 **MICRO IRRIGATION SYSTEMS**

B) OPERATION AND MAINTENANCE OF FILTRATION SYSTEM

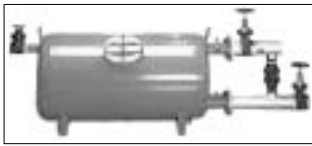

Manual Sand Filter

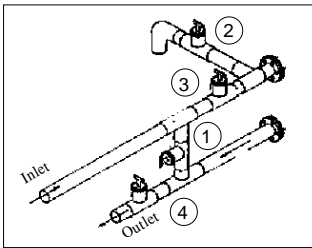

Manual Sand Filter (Single Unit)

A) Manual Sand Filter :

Backwashing is done by opening & closing all (i.e. inlet, outlet, backwash & bypass) the four valves manually.

While backwashing the Sand filter, always open backwash valve, then only close outlet valve, after this, open the middle valve and then close inlet valve.

Operation (Single Unit) :

To start the backwash operation backwash valve, (1) and by pass valve (2) are open inlet valve (3) and outlet valve (4) are closed manually. Raw water is forced through the sand media via exit port thereby fluidising the media. All floating dirt moves through the by pass valve (2).

To resume the filtration operation, inlet valve (3) & outlet valve (4) are opened & backwash valve (1) & bypass valve (2) are closed manually.



Vertical Sand Filter

Operation (Multiple Unit) :

To start the backwash operation, backwash valve, (A) of one unit is opened and inlet valve (B) is closed manually. Filtrated water from adjoining filter is forced through the outlet port of unit under backwash mode thereby fluidising the media. All floating dirt moves through the backwash valve (A).

Sand filters must contain atleast 1/2 part of sand. If it is less, take it up to requisite level by addition. Less of sand means less of a filtering capacity. The sand must be of specific type and not any sand found by river side.

To resume the filtration operation inlet valve (B) is opened & backwash valve (A) is closed manually.

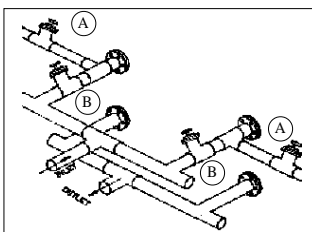

Manual Sand Filter (Multiple Unit)

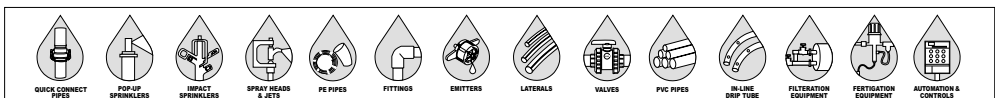



CHAPTER - 4 MICRO IRRIGATION SYSTEMS

B) OPERATION AND MAINTENANCE OF FILTRATION SYSTEM

B) Semiautomatic Sand Filter :

No need to operate all four valves (i.e. inlet, outlet, backwash & bypass valve). Backwashing can be performed by operating single three way valve. These hydraulic valves are operated on hydraulic pressure through hydraulic control tube connected between the hydraulic valves and three way valve.

Major advantage of semiautomatic sand filters are no more confusion between operation of four valves. Smooth opening and closing operations of hydraulic valves eliminates the possibility of development of back pressure due to delay in closing and opening of valves.

Operation (Single Unit) :

To start the backwash operation, turn the knob of 3 way control valve entry port as shown in fig. "A" hydraulic command will automatically close the inlet valve (3) and outlet valve (4) and open the backwash (1) and bypass valve (2). Raw water is forced through the sand media via outlet port thereby fluidising the media. All floating dirt moves through the backwash valve.

To stop the backwash operation and to resume filtration turn the knob of 3 way control valve to the port open to atmosphere As shown in fig. "B" Automatically the inlet valve (3) and outlet valve (4) will get closed.

Operation (Multiple Unit) :

To start the backwash operation, turn the knob of 3 way control valve to entry port as shown in fig "A" hydraulic command will automatically open the backwash valve (A) and close the inlet valve (B) of that filter. Filtered water from adjoining filter is forced through the exit port of unit under backwash mode thereby fluidising the media. All floating dirt moves through the backwash valve (A).

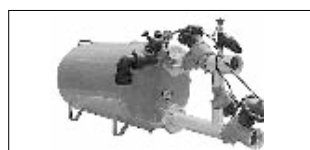

Semi Automatic Sand Filter (Single Unit)



Semi Automatic Sand Filter (Vertical)

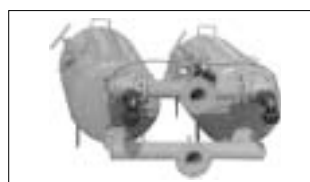

Semi Automatic Sand Filter (Multiple Unit)

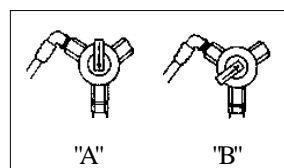

3 - way valve operation

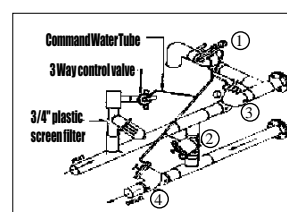

Semi Automatic (Single Unit)

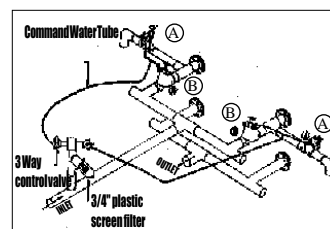

Semi Automatic (Multiple Unit)

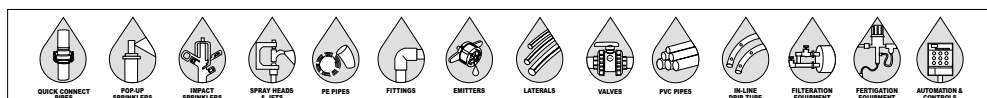



CHAPTER - 4 **MICRO IRRIGATION SYSTEMS**

C) FULLY AUTOMATIC SAND FILTER :

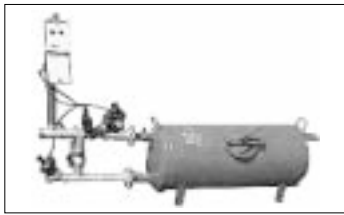

Fully Automatic Filter

Fully automatic sand filter provides you unattended flushing of the filters on a pre-scheduled time interval basis. You can even adjust backflushing on pressure differential (PDS) basis

Operation (Single Unit) :

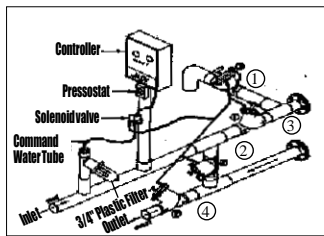

Fully Automatic (Single Unit)

PDS or controller sends signal as per the the set time interval or set differential pressure to the solenoid valve for given hydraulic command. Hydraulic command will automatically close the inlet valve (3) & outlet valve (4) and open the backwash valve (1) & bypass valve (2). Raw water is forced through the sand media via outlet port thereby fluidising the media. All floating dirt moves through the backwash valve (1).



Filter Flushing Controller

On completion of flushing cycle, the solenoid valve closes, thereby allowing the pilot valve to bleed-off which in turn closes the backwashing valve (1) & bypass valve (2) and open inlet valve (3) & outlet valve (4). Hence resuming filtration.

Operation (Multiple Unit) :



Fully Automatic (Multiple Unit)

PDS or controller will send signal as per the set time interval or set differential pressure to the solenoid valve for given hydraulic command. Hydraulic command will automatically open the backwash valve (A) and close the inlet valve (B) of that filter. Filtered water from adjoining filter is forced through the exit port of unit under backwash mode thereby fluidising the media. All floating dirt moves through the backwash valve (A).

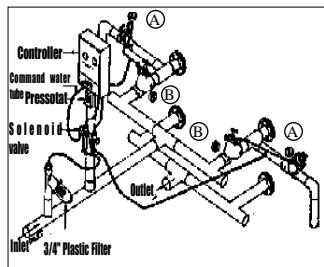

Fully Automatic (Multiple Unit)

On completion of flushing cycle the solenoid valve closes there by allowing the pilot valve to bleedoff which in turn closes the backwash valve (A) and opens inlet valve (B). Hence resuming filtration.

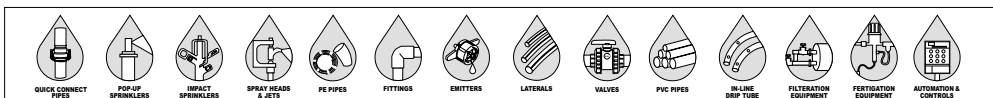



CHAPTER - 4 **MICRO IRRIGATION SYSTEMS**

C) FULLY AUTOMATIC SAND FILTER :

3) Screen Filters :

Stainless steel screen is used as filtration media for trapping the dirt from the water. Different size of mesh i.e. 80-200 are used according to the quality of water & type of emitters used.

Screen filters are most common filters used in irrigation system. They are easy to install & maintain. They are placed after hydrocyclone and sand filters.

Screen filters are available in metal as well as in plastic material and in 'Y' & 'L' shaped bodies. Plastic screen filters are light weight, smooth surfaced and corrosion resistant.

Maintenance of Screen Filter :

Flushing at scheduled daily interval is necessary to maintain your screen filter. It is recommended to flush your screen filter, if pressure drops more than 0.5 Kg/cm² (5 m at water). The pressure difference can be observed by checking inlet and outlet pressure by using a single 3-way control valve

Flushing can be done by simple opening of the drain valve, allowing the force of water to flush the dirt out through drain valve. It is also necessary to clean the screen at regular interval. Procedure of cleaning is very simple, open the screen filter lid, remove the screen & clean it in flowing water by rubbing with cloth or soft nylon brush.

Brush Clean Filters are available with brush at the centre of element. Screen element can be cleaned by rotating the handle which revolved shaft & brush. No need to open the cover & removal of element.



Metal Screen Filter ('Y' Shape)

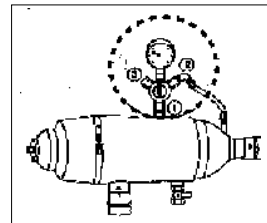

Filter with 3 Way control valve

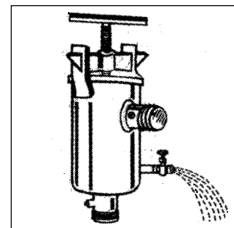

Filter Flushing

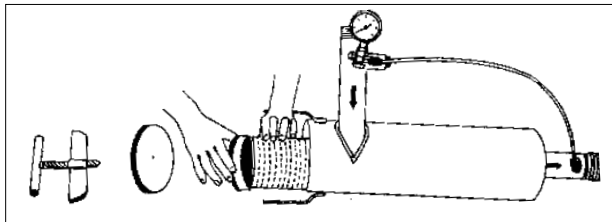

Cleaning of screen filter

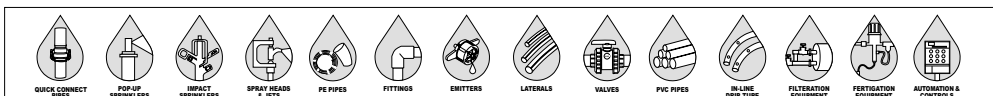



CHAPTER - 4 MICRO IRRIGATION SYSTEMS

INSTALLATION & OPERATION OF FERTIGATION AND CHEMIGATION EQUIPMENTS

Three types of fertigation and chemigation equipments are most commonly used

A) VENTURY INJECTOR :-

It is most common type of injector used to inject water soluble fertilizer to your irrigation system. It is

- very simple and efficient
- differential pressure injection device.

HOW YOUR VENTURY INJECTOR WORKS :-

When water under pressure enters through the inlet the flow is constricted towards the ventury throat and changes into a high velocity jet stream. Increase in velocity results in decrease in pressure enabling fertilizer to be sucked up through the suction port. As the jet is diffused towards the injector outlet its velocity is reduced and is reconverted in to pressure energy.

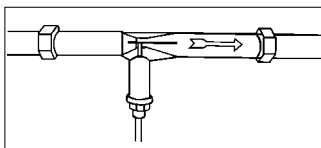

Ventury

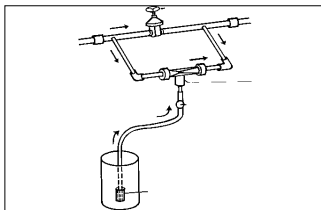

PRECAUTIONS:-

- Always run your ventury operation with clean water for 10 -15 minutes after fertilizer application. It will prevent the suction port of ventury from clogging.

- Ensure equipments used to handle the acid are resistant to acid attack.

B) FERTILIZER TANK :-

Fertilizer Tank operates on the basis of differential pressure between inlet and outlet. Fertilizer tank is easy to operate and install.

INSTALLATION :-

Install the fertilizer tank after the non return valve to prevent the reversal of flow. Attach inlet (with extended



Fertilizer Tank

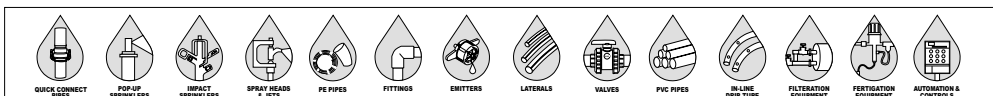



CHAPTER - 4 **MICRO IRRIGATION SYSTEMS**

pipe in to tank) & outlet (without pipe) of the fertilizer tank to inlet & outlet of manifold as shown in figure.

OPERATION :-

- 1) Close the inlet and outlet valves of fertilizer tank.
- 2) Fill the tank with the required amount of fertilizer through the man-hole, after removing the lid.
- 3) Tighten the man-hole lid properly.
- 4) Open the outlet valve and then the inlet valve.
- 5) Create the pressure difference between inlet and outlet by controlling the manifold valve on main line.

Thumb rule: When a volume of water equivalent to three times the tank's capacity flows through the tank, all the fertilizer in the tank will have been injected into the system.

On the basis of this thumb rule the operation duration of the fertilizer tank is given below for various pressure difference and tank capacity:

Table : Operation time for Jain Fertilizer Tank (minutes)

Inlet & Outlet pressure difference (kg/cm ²)	Jain Fertilizer Tank capacity (litres)		
	90	120	160
0.2	25	30	40
0.3	15	15	20
0.5	10	10	15

Keep the lid of Filter and Fertilizer Tank fully tightened while in operation.

C. FERTIGATION PUMP :-

To maintain the proportion and accuracy of injection rate fertigation pump can be used. Water soluble fertilizers can be applied precisely and at constant concentration to your irrigation system by using fertigation pumps.

Fertigation pump is available in various types and according to its maximum flow rate and adjustable injection rates.

Fertigation pump can be directly installed on the main line or on the bypass assembly and in series or in parallel if required.

It does not require electricity for its operation. It is operated on water pressure.

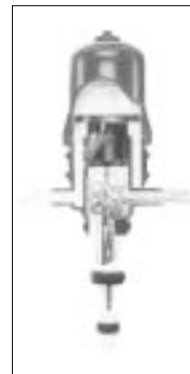

Fertigation pump

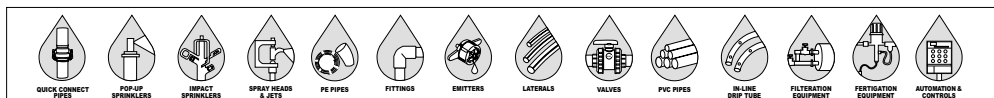



CHAPTER - 4 **MICRO IRRIGATION SYSTEMS**

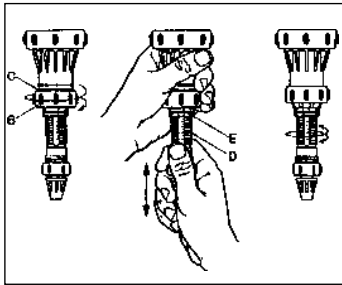

Percentage setting

Fertigation pump sucks up water in preset percentage of incoming flow rate. This incoming flow rate can be determined by counting the number of clicks of piston. Once inlet flow rate is known required percentage can be adjusted to get desired injection rate.

Trouble shooting for Fertigation Pump.

Problem	Cause	Remedies
1) Water flowing back into the solution tank	Worn or contaminated Suction Valve seal	Clean or change the suction valve seal
2) No suction	Air in the suction pipe	Check the tightening of the nuts in the injection assembly
	Blocked suction tube or clogged up strainer	Clean these items (Important : Avoid putting the strainer at the bottom of the drum. Always leave a minimum of 10 cm / 4")space at bottom
3. Under Injection	Suction of air, worn suction valve seal	Change or clean
	Flow exceeded than maximum	Reduce the flow
	Worn plunger seal	Change
	Worn injector body	Change
4) Leaks in the black nut under the motor body	Watertight seal is wrongly positioned, damaged	Position correctly or change
5) Leaks between the the body and the bell housing	Seal missing,wrongly positioned or damaged	Remove the bell housing. Clean seal seating and put back the seal or change. Screw on thebell housing keeping it upright.

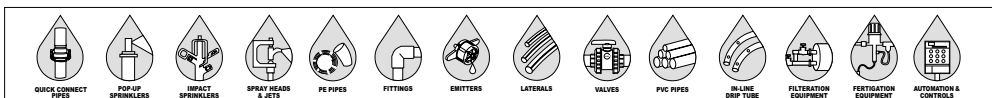



MAINTENANCE OF MICRO IRRIGATION SYSTEM

CHAPTER - 5

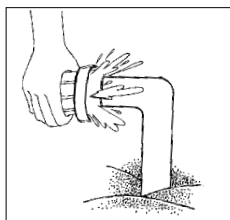

Submain Flushing

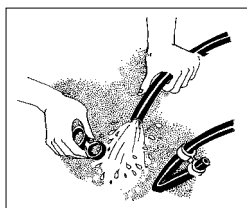

Lateral/Drip tape Flushing

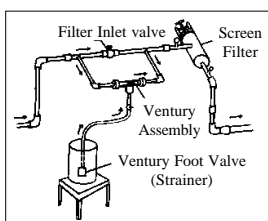

Ventury

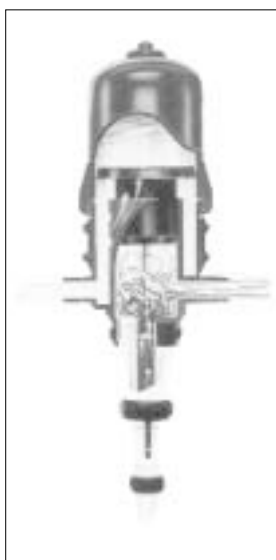

Fertigation pump

Submain and Lateral/Drip Tape Flushing

Most of the silt, dirt, foreign bodies coming with water are entrapped and removed by sand and screen filter. Still some silt passes onwards and comes in submains and laterals/drip tapes. Also some times algae and bacteria lead to the formation of slimes/pastes in the pipes and laterals/drip tapes. To remove these silts and slimes, the submains should be flushed by opening their closed ends. By flushing, even the traces of accumulated salts will also be removed. The flushing can be stopped, once the water coming out is clean.

CHEMICAL TREATMENT

Clogging of drippers/drip tapes will be due to precipitation and accumulation of certain dissolved salts like Carbonates, Bicarbonates of Iron, Calcium and Magnesium salts. The clogging is also due to the presence of micro organisms and the related Iron and Sulphur slimes due to algae and bacteria.

The clogging is usually avoided by chemical treatment of water. Chemical treatments commonly used in drip irrigation systems include application of either chlorine or acid to the irrigation water.

The frequency of the chemical treatments is best known to the farmer using the system. As a general rule, perform acid treatment once in 15 days. For detailed information refer chapters 2 & 4 on Chemigation and Fertigation.

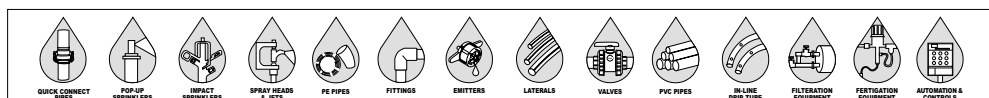



MAINTENANCE OF MICRO IRRIGATION SYSTEM

CHAPTER - 5

A) Acid Treatment

Acid treatment is done to prevent the precipitation & accumulation of dissolved salts in the drip irrigation system.

Hydrochloric Acid (HCL) is injected into drip system at the rate suggested in the water analysis report. The acid treatment is performed till a pH of 4 is observed at the last lateral and dripper. Then the system is shut off for 24 hours. Next day the system is flushed by opening the flush valve and lateral/drip tape ends before continuing normal operation.

B) Chlorine Treatment

Chlorine treatment in the form of bleaching powder is performed to inhibit the growth of micro organisms like algae, bacteria etc. The bleaching powder is dissolved in water and this solution is injected into the system for about 30 minutes. Then the system is shut off for 24 hours. After 24 hours, the lateral ends and flush valves are opened to flush out the water with impurities. Bleaching powder can also be directly added into the source at a rate of 2 mg/litre.

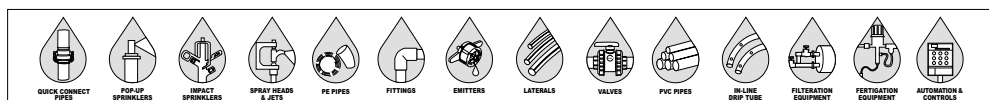



MAINTENANCE OF MICRO IRRIGATION SYSTEM

CHAPTER - 5

IRRIGATION

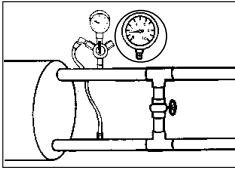

1) As per requirement, open sectional valves of the particular section. Please refer technical data sheet provided along with design drawing.

2) Pressure at the inlet of the submain should be 1 Kg/cm^2 . Unless it is so, drippers will not give rated discharge as per design. For drip tape system, the pressure at the inlet of the submain should be 0.7 kg/sq.cm. & for Micro Jets, Micro Sprinklers, foggers & misters, it should be 1.5 kg/cm^2 .

3) When submerged leather seat of the footvalve is spoiled, most often; the farmers use dunk or mud to seal the leak but care must be taken that this dirt is discharged through bypass and does not enter into the filter. Otherwise there is possibility of layer formation of this dunk or mud along with sand affecting filtering efficiency of the sand filter.

4) The arrangement of bypass valve is a must. If it does not exist, It must be made.

5) All the drippers of the system should give uniform flow and to confirm this water coming out per hour from each dripper must be measured. If the drippers are choked up due to the dirt particles, they emit less of water leading to uneven emission from different drippers of the system. To avoid this, drippers need be opened & cleaned. If the lateral leaks or is folded, this may also lead to loss of pressure & hence less of water emission.

6) Drippers can be cleaned without pulling them out from the laterals. While pulling them out of laterals, if one does not pull them out straight, the holes in the lateral might get bigger causing leakage.

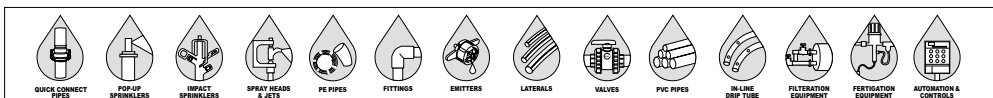



MAINTENANCE OF MICRO IRRIGATION SYSTEM

CHAPTER - 5

7) Wetting pattern formed in the soil due to drippers or drip tape should be frequently observed & if found uneven, necessary action should be taken immediately. Necessary action means cleaning of main, submains, laterals, drippers etc. and also giving chemical treatment.

8) Keeping in mind the intercultivation involved and also assuming threats from squirrels, rats & also the mechanical impacts, it is always safe to bury the laterals 3"-4" deep in the soil. Only dripper & surrounding small portion should be exposed so that dripper should not be clogged.

9) If the drip system is kept off for some days, there is possibility that spider or some similar insects may spin cobwebs inside the system, leading to reduced water supply. It is therefore necessary to open and clean the drippers regularly.

10) If some drippers spray water, it is because of inadvertence during the cleaning of the dripper, the circular disc inside turbokey dripper or rubber diaphragm in case of pressure compensating dripper must have fallen out and hence new one be placed. It may be also due to high operating pressure and air entrapment..

11) If the lateral is cut, it can be joined with poly-poly joiner. Holes in the lateral can be closed by using goof plug.

12) The end cap / stop of laterals and flush valve at the end of submain should always be in closed position. If left open, these points may allow pressure loss / drop and also water wastage.

13) Do not pull the laterals with force while shifting, rotating / unrolling.

14) Operation of valve should be proper as per the direction given on valve without tampering with the factory setting / assembly.

15) Roll the laterals properly in coil form while removing the laterals from the field and ensure that no damage is done to GTO while folding lateral-tubes.

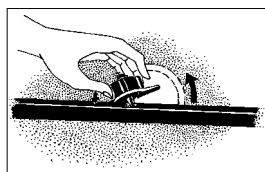

Don't Pull Drippers like this

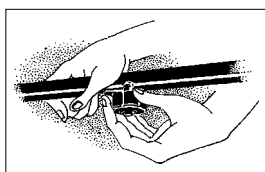

Open the Cap of the Dripper like this

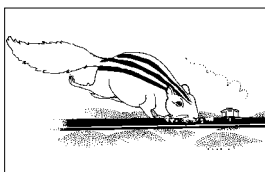

Squirrel Menace
Lateral on the Ground
Surface

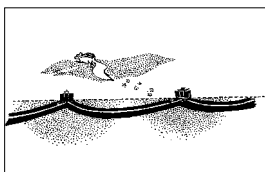

Lateral below the Ground at
a depth of 3" - 4"

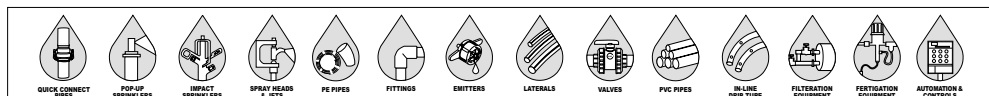



MAINTENANCE OF MICRO IRRIGATION SYSTEM

CHAPTER - 5

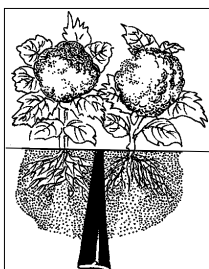

Drip Tape System for Vegetables

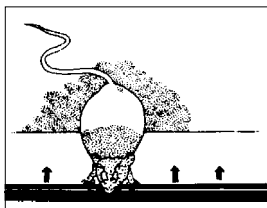

In dry Soil, Rat menace is more

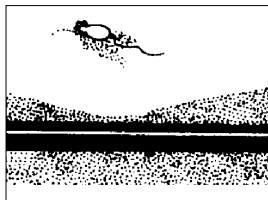

Wet Soil - less menace of rats

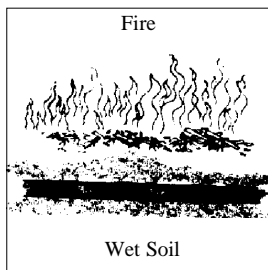

Wet Soil

Jain Turboline

Maintenance

1. Before planting, the J-Turboline should be run continuously for 24 - 48 hrs. to ensure sufficient moisture for germination. This is known as planting / germination irrigation. The duration of this irrigation depends upon the season, climate and soil/crop.
2. As the J-Turboline is placed 6" - 8" & below soil, planting is also done at the same level because of this, roots get support & earthing up can be avoided. If required, earthing up can be done from the outer side.
3. If the J-Turboline is run daily, the rat menace can be considerably reduced. Use of kerosene, neem cake, zinc phosphate tablets are some other measures to control the rat problems.
4. J-Turboline must be operated even in rainy season, atleast for 2-3 hrs. in a week, not for irrigation but to flush the J-Turboline. Otherwise the holes may get clogged & also bacterial or algae growth may take place.
5. To take out the J-Turboline from soil, it should be run for 24 to 48 hrs. to get sufficient wetting of soil & then the entire tape is taken out easily.
6. Ensure that the J-Turboline is chemically treated before taking it out.
7. When it is taken out, it should be properly wound & stored in a safe place to protect from rats, ants etc.
8. During harvesting, tractor or bullock cart should not be taken in the field. It may damage the J-Turboline.
9. The labour should be made well aware of the J-Turboline & care should be taken to avoid damage to the J-Turboline.

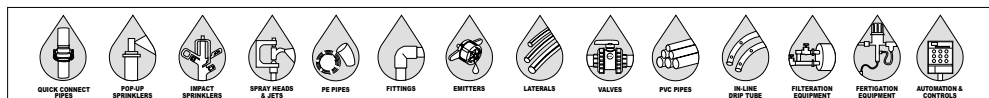



MAINTENANCE OF MICRO IRRIGATION SYSTEM

CHAPTER - 5

10. It is always safer to burn the sugarcane trash out of the field. But if burnt in the field, first ensure that the J-Turboline is completely covered with soil & on the previous day the systems should be run to wet the soil sufficiently.

After burning the trash, the J-Turboline should be taken out carefully if ratoon crop is not to be taken.

11. We recommend the farmers, ratoon crops of sugarcane for 2/3 years. For ratoon crops, water stress should be given for some period. This helps in better tiller development.

12. In the beginning the growth of tillers is not uniform so these should be cut in order to get uniform growth of sugarcane.

13. If proper care regarding fertilizers, interculturing is taken the ratoon crop gives more yield than the main crop.

14. In the first 4-5 months (Feb - May) there are chances of infestation of stem borer due to shortage of water. During this period, care should be taken to wet the whole root zone. Once the rootzone is wetted, the J-Turboline should be run every alternate day or after every two days. This horizontal movement of the water will result in better root development. It also prevents lodging of the canes to a large extent.

15 Regular acid treatment is necessary to avoid chemical precipitation & clogging up the system.

16 Ensure proper chlorination to control the algae and bacteria growth in the system.

17. Run the system for recommended duration to create sufficient moisture in the soil. Otherwise root intrusion problem may arise.

18. When the lateral lines are buried, there is a clogging risk due to the penetration of roots in the emitter outlets. When this type of clogging appears, it is possible to clean the emitters by injecting a herbicide, chlorine or acid in the system at the end of the irrigation cycle.

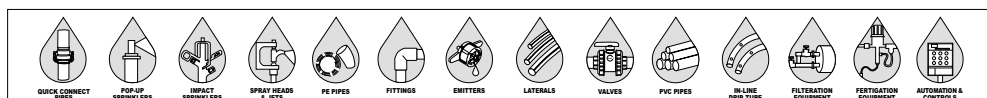



MAINTENANCE OF MICRO IRRIGATION SYSTEM

CHAPTER - 5

Seasonal Crops :

Drip tape can also be efficiently used in vegetables like tomato, chilly, cabbage, flowers, brinjal & row crops like Cotton, ground nut, sunflower etc. At the end of the season the drip tape should be chemically treated & then carefully removed from the soil, so that it can again be used in next season.

Length Micro Dripper (Microtube) :



Microtube

Some farmers prefer microtubes instead of drippers. All the above mentioned precautions & after cares are applicable to microtube also.

Following are few more points to be remembered about Microtube.

1. The Microtube should be sufficiently inserted i.e. 2"-3" inside the lateral otherwise it may come out due to pressure.
2. The free end of the micro tube should always be kept in the root zone area.
3. The free end of microtube may get clogged by soil or salts reducing the water flow. This will result in under irrigation of the crop. To avoid this, the field should be frequently observed & microtubes be regularly cleaned, so that the crop will receive required quantity of water.

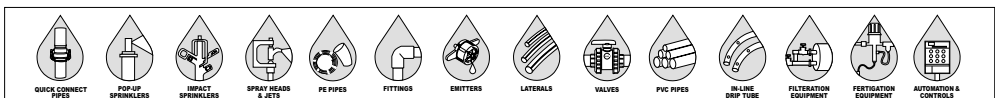



SPRINKLER IRRIGATION SYSTEM

CHAPTER - 6

Floppy Sprinkler is a unique revolutionary sprinkler with no moving parts & having standard built in flow regulator.

Working Principle

A flexible silicon tube is mounted over this sprinkler. The outcoming water jet exerts a force on the flexible tube which shakes it to and fro. At the same time the unique design of sprinkler creates a vortex force in to the water jets which helps to rotate the flexible tube informally.

In Pop-up model, the flexible tube is housed in a cylindrical body for protection against damage due to bird and manual menance. The flexible tube pops-up under the water pressure and pops-down when water pressure recedes.

Floppy sprinkler is provided with unique pressure regulator which keeps the discharge uniform over a wide range of pressure.

Floppy sprinkler is available in various colour coded models for different discharge i.e. Blue 300 LPH , Green 500 LPH , Black 750 LPH & Yellow 950 LPH

As all the parts used are of plastic material the floppy sprinkler is rust free, light in weight and inexpensive as compared to impact sprinkler. It 's bigger droplets permit effective operation even in high wind condition. Floppy sprinkler can be efficiently used for nursery, flower beds, pulses, tea, coffee, sugarcane, onion, potato, tomato, chilli and other vegetable either on flat or undulating land. It is also suitable for orchard crops such as mango, citrus etc.

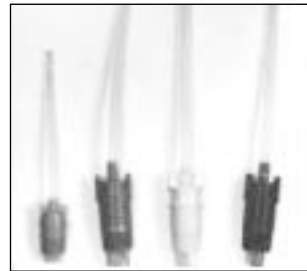

Floppy

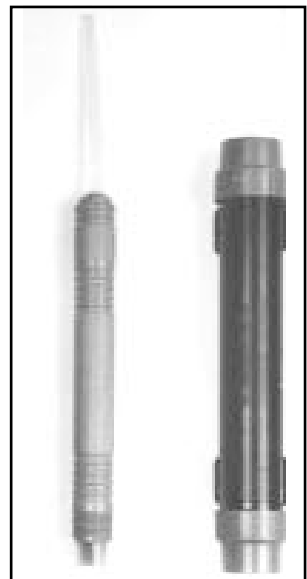

Pop-up Floppy



Pressure / Flow regulator

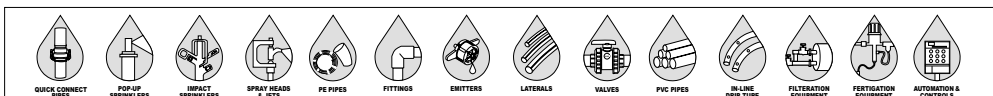



CHAPTER - 6 SPRINKLER IRRIGATION SYSTEM

Installation of Floppy / Pop-up Floppy Sprinklers -

- 1) The riser height should be as per the design and above the bed surface intended to be irrigated (not from the submain level).

The riser height should be at least one meter above the bed surface.

For heighted / tall crops, like sugar cane the riser height can be kept even up to 3.5 meters depending upon expected height of crops.

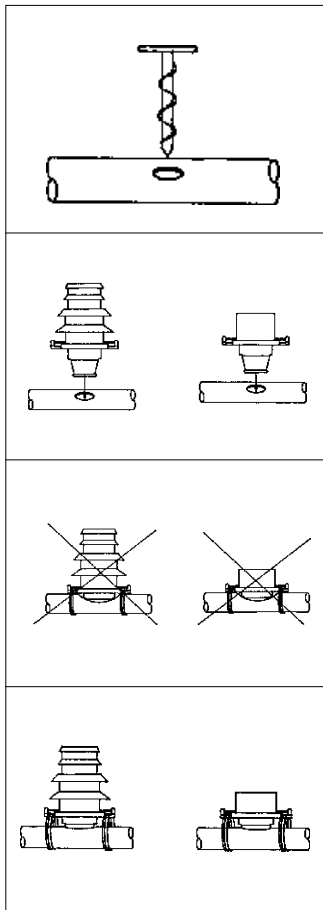

2. It is recommended to use triangular spacing pattern for uniform application rate and to prevent dry patches.
3. Ensure that the risers are vertical and not bending towards any side.
4. Push the flow controller fully in to body before installing it on the riser.
6. Use teflon tape on floppy sprinkler thread while installing on the riser
6. No tools should be used for installing floppy or pop-up floppy sprinkler
7. Use saddles on oval hose / polytube and on HDPE Pipes. Procedure for installation of Floppy Saddle Assembly is explained below.
8. Ensure that sufficient air release valves are installed in the system.
9. Flush the system before commissioning, to remove dirt.
11. Use screen filter to avoid blockage of pressure regulator and damage to silicon tube.
12. Do not cut the silicon tube, sprinkler will not function if the tube is shorter.

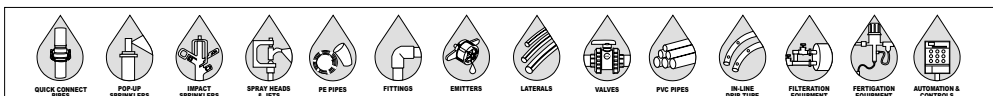



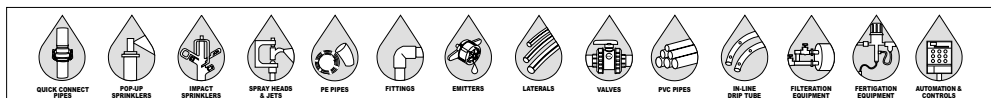

Trouble Shooting

PROBLEM	CAUSE	REMEDY
1. Sprinkler silicon tube does not rotate	<p>The pressure may be too low</p> <p>Leakage in the feeder lines</p> <p>Blocked pressure regulator</p> <p>Air locks in the mainline or submain release</p>	<p>Check the system pressure and adjust it as per design.</p> <p>Check leakage in pipe and valves. Repair or replace it.</p> <p>Clean the pressure regulator and reinstall it.</p>
2. The silicon tube swells up or burst	<p>The silicon tube needs breaking in.</p> <p>Excessive air in the pipe line alongwith water hammer</p>	<p>Install sufficient air valves.</p> <p>Use pop-up floppy sprinkler which can act as an air release valve as well as sprinkler.</p> <p>Gently strike the silicon tube by hand.</p> <p>Open the valve slowly to prevent water hammer</p> <p>Ensure sufficient air release valves in the System.</p>
3. Animal eating of the silicon tubes	-	<p>Install pop-up floppy sprinkler instead of the regular floppy sprinkler.</p> <p>If possible, remove the sprinkler from the field when they are not in operation.</p>





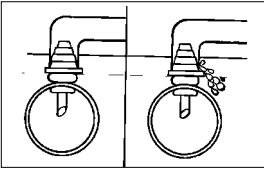
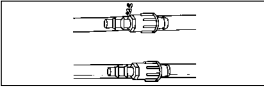
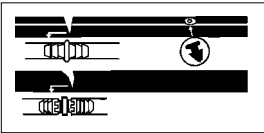

CHAPTER - 7 TROUBLE SHOOTING AND REMEDIES

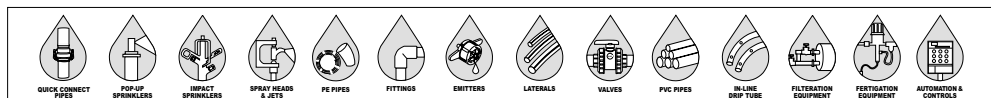
SR. NO.	PROBLEM	CAUSE	REMEDY
01.	Leakages at Submain 	<ul style="list-style-type: none"> • Lateral/polytube at the start is without sufficient allowance. • Quite tightly placed polytube with slight pull by animals or people. • Grommet takeoff comes out or gets loosened. 	Dig the soil near submain and place correctly the grommet takeoff inside the submain. Keep necessary allowance for lateral at the beginning.
02.	Leakages at drip tape/lateral joints 	Like above due to slight jerks, joints get stretched and become loose.	Place correctly the nut of joiners and the joiners into drip tape at one end and lateral at another end.
03.	Leakages along lateral/drip tape 	Lateral/Drip tape is damaged by mechanical devices or by squirrels, rats, animals etc.	<ul style="list-style-type: none"> • Small holes in the lateral can be closed by goaf plugs • At the cut section, put drip tape joiners correctly for lateral/ Drip tape or put required piece of it with joiners.
04.	Difference between the inlet & outlet of filter is more than normal. 	<ul style="list-style-type: none"> • Filters are not cleaned. • Quantity of sand is more in the sand filter. • Pressure gauge may be faulty 	<ul style="list-style-type: none"> • Daily backwash the sand filter for atleast 5 minutes. • Clean sand & screen filters thoroughly by opening their lids atleast once in a week. • Change the faulty gauge
05.	Pressure gauge doesn't show readings 	<ul style="list-style-type: none"> • It has either gone out of work due to rusting or some jerk injuries or pointer has stuck up. • Pressure beyond the operating range. 	<ul style="list-style-type: none"> • Allow dirty water to bypass first and then take into filter. • To avoid rusting, position the pressure gauge such that rain water won't go in. • Put Plastic cover over it. If indicator is stucked up, open the gauge and check up the indicator. • Keep the pressure within the the operating range.



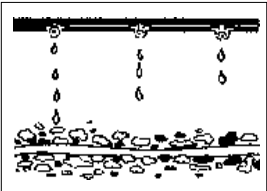

CHAPTER - 7 **TROUBLE SHOOTING AND REMEDIES**

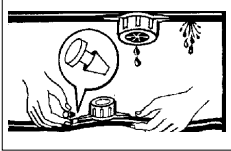
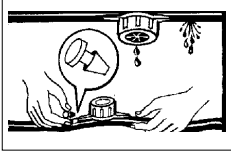
SR. NO.	PROBLEM	CAUSE	REMEDY
06.	Non-uniform dripper discharge. 	<ul style="list-style-type: none"> • Clogged drippers. • Algae and salt accumulation inside drippers and laterals. • Submains and laterals are not flushed properly. Laterals are pinched or leakages developed somewhere along the length of lateral. 	<ul style="list-style-type: none"> • Open the drippers and clean thoroughly. • Filters, Laterals and Submains are to be flushed regularly once in a week. • Carry out necessary chemical treatment as per the recommendations. • Check the lateral for pinching and leakages if any.
07.	Non uniform discharge with dry patches of soil in the drip tape system. 	<ul style="list-style-type: none"> • Algae growth within the filter or drip tape. • Salt accumulation inside tape & holes are blocked. • Air release valve is not at proper place or not working and hence silt particles are sucked in. • Clogging the holes due to negative suction created when irrigation is stopped. 	<ul style="list-style-type: none"> • Daily backwash of sand filter for 5 minutes and flushing of submains and drip tape thoroughly once in a week. • Carry out acid and chlorine treatment as per recommendations • Air release valve should be located at the higher points along the submain.
08.	Leakages at dripper placement on the lateral. 	<ul style="list-style-type: none"> • Drippers are taken in and out many times unnecessarily. • Holes become oblong and bigger in size. 	<ul style="list-style-type: none"> • Such holes can be closed with goof plugs. • For bigger holes put joiners.
09.	Low discharge with Low pressure reading 	<ul style="list-style-type: none"> • Sand filters quite dirty and no proper cleaning • Water level in source has gone down. • Pump working is not proper 	<ul style="list-style-type: none"> • Sand filter should be thoroughly cleaned and backwashed daily. • If water level has gone down, pump placement should be changed to further down. • Pump should be checked for its working. • If this doesn't then suggest new pump as per requirement of head and discharge.

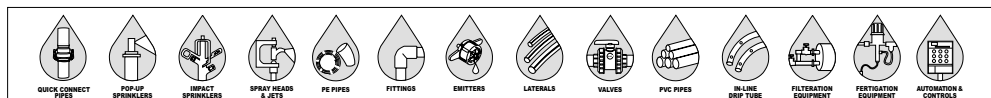



CHAPTER - 7 **TROUBLE SHOOTING AND REMEDIES**

SR. NO.	PROBLEM	CAUSE	REMEDY
10.	No discharge at the lateral/drip tape end.	Lateral/drip tape is cut or pinched somewhere in between.	<ul style="list-style-type: none"> • Check lateral/drip tape along the length for pinching or cut. • Straighten it if pinched and put joiners wherever necessary.
11.	Excess pressure at the filters.	No by pass assembly.	<ul style="list-style-type: none"> Install bypass assembly to divert excess flow and maintain desired flow and pressure.
12.	Ventury is not working.	<ul style="list-style-type: none"> • Lower pressure than recommended at the pressure gauges. • Leakages in the ventury assembly. • Pump working is not proper. 	<ul style="list-style-type: none"> • Control the By -pass Valve • Check pump Working for low pressure and check the ventury assembly properly fitted for its correct direction & leakages.
13.	Sand comes in the screen filter along with trash, straws etc.	Sand filter elements (black candles) are either loosened or not in the place.	<ul style="list-style-type: none"> • Check the black candles for their proper place and properly fitting. • While cleaning the sand filter, black candles should not be disturbed with hand movement.
14.	Very dirty water comes out at the ends of lateral/drip tape.	<ul style="list-style-type: none"> • Water is quite dirty with lot of silt. • Laterals/drip tapes are not flushed for a long time. 	<ul style="list-style-type: none"> • Lateral/drip tape should be flushed once in a week regularly otherwise drippers will give uneven discharge and drip tape holes get clogged.
15.	Fibrous slime or white crustation growth material comes out through the lateral/ driptape ends.	<ul style="list-style-type: none"> • Water contains high quantity of salts in the form of white crustation • Laterals/drip tapes have not flushed for a long time. 	<ul style="list-style-type: none"> • For salts in the form of white crustation, carry out acid treatment and for fibrous slime growth of algae carry out chlorine treatment as per the recommendations.
16.	Air release cum vacuum release valve leaking constantly.	Valve 'O' ring has deviated from its base and obstructs in the proper working.	<ul style="list-style-type: none"> • Position the 'O' ring properly or replace new if turn out.

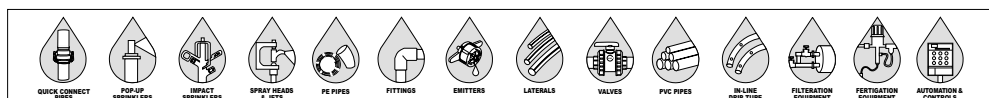



Pumping system is the vital part of drip irrigation system. The efficient and trouble free pumping system enhances the life and efficiency of drip irrigation system.

Types of Pump :

Pumps can be categorised as,

- A) Rotodynamic Pump - e.g. centrifugal pump, volute turbine pump etc.
- B) Positive displacement pump - e.g. reciprocating pump, deepwell etc.

Generally centrifugal pumps are commonly used in irrigation system. Protection of pumping unit of an irrigation system has two objectives,

- 1) Protection of pumping system i.e. pump, starter electrical connection etc.
- 2) Protection of an irrigation system from pressure surge, water hammer cavitation etc.

1) Protection of Pumping System :

Foundation:

Suitable mountings are essential for satisfactory operation and the surface on which pump is mounted should be flat and level. Motor should not be mounted very near to wall as otherwise ventilation of the motor may be obstructed.

Suction and Discharge Piping:

While fixing the suction & discharge pipes the weight of long piping should be suitably supported and must not be allowed to rest on the pump. Before fixing the pipes make sure that no dirt or grit has got in to the pumps and pipes. The joints of the suction piping must be air tight, otherwise air leakage will take place, causing reduced pumping capacity, or the pump will fail to lift water at all. Suction piping should preferably have a continuous rise from the suction water level of the pump. The end of the suction pipes should be well submerged, about two feet, but must be kept clear of deposits of mud, silt, grit etc. It should also be kept clear of side walls. Always use a foot valve to keep the suction pipe full of water when the pump stops.

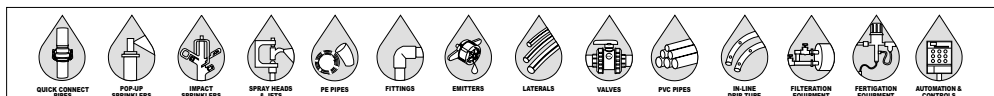



CHAPTER - 8 PUMPING SYSTEM

Electrical Wiring:

Pump wiring should be carried out in accordance with the instruction given by the pump manufacturer. Use of electronic starters with suitable timer arrangements and high voltage preventer is desirable. Wiring should not be kept open, it should always be carried through electrical conduits.

2) Protection of Irrigation System:

Pipelines break because of too much pressure. If a pipe breaks, pump damage is risked and crop losses around the break are also likely. Use of pump control valve, to stop the pump, prevents such damages.

Pipe line can also be protected by monitoring the pump out put and taking care to open and close valve slowly to avoid Water Hammer. Pressure fluctuations (Water hammer), often associated with turning pumps on or off at full speed, can cause damage to pipes and fittings. To avoid these problems, provide a sufficient bypass arrangement. Keep bypass open when you start the pump and close it slowly allowing slow rise in system pressure.

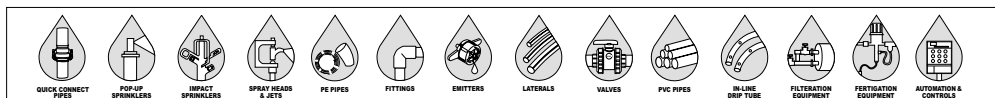



CHAPTER - 8 **PUMPING SYSTEM**

Pumping Do's and Don't	
Do	Don't
<ul style="list-style-type: none"> * Site the pump as close as possible to the water * Make sure suction and delivery pipes do not put a strain on the pump casing * Check that all pipe connections are tight * Use Jain foot valve in suction line * Anchor the pipe securely so that it doesn't move during operation * Work the pump within its limits * Provide ventilation for the motor or engine * Keep the pump and motor connection aligned * Make sure the pump is primed before starting. * Service the pump regularly 	<ul style="list-style-type: none"> * Pump corrosive liquids * Operate the pump without water * Operate the pump if the discharge valve is closed. * Operate the pump if the foot valve is blocked. * Operate the pump if it is vibrating excessively * Install the suction pipes where air can build up. * Forget to do regular maintenance * Alter the desinged / recommended pump. * Change the water source without ascertaining the quality of water. * Mix cow dung in suction piping to prevent stop leakage in the foot valve.

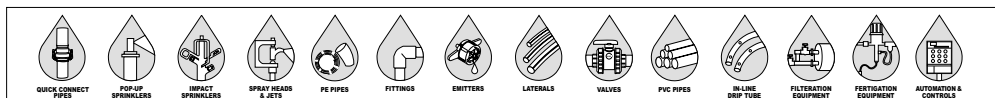



CONSUMER ADVISE



1. Keep the bypass valve "OPEN" before switching "ON" the pump and adjust / close the same gradually to adjust the recommended pressure on the mainline.
2. Always install suitable pump as per recommendation.
3. Always maintain the recommended operating pressure at filtration unit & submains.
4. Operate the system as per given irrigation schedule only. Do not under or over irrigate.
5. Keep the lid of Filter and Fertilizer Tank fully tightened while in operation.
6. Backwash the Filtration System (Sand Filter, Screen Filter) regularly.
7. While backwashing the Sand filter, always open backwash valve, then only close outlet valve, after this, open the middle valve and then close inlet valve.
8. Flush the main, submain, laterals and filters at frequent intervals depending upon the water quality.
9. Carry out the chemical treatment regularly to prevent dripper clogging. This needs to be done as per recommendations.
10. Always add acid to water while conducting acid treatment. (Do not pour water to the acid).
11. Drawing water for drinking from the system should be strictly avoided & particularly during chemigation and fertigation.
12. Root intrusion can occur if plants are under-irrigated or if chemicals and fertilizers are not flushed out of the line properly. Ensure adequate irrigation.
13. Periodically inspect the drip irrigation components above the ground for physical abuse, damage by field machinery, rats, squirrels etc., at regular intervals.
14. The end cap / stop of laterals and flush valve at the end of submain should always be in closed position. If left open, these points may allow pressure loss / drop and also water wastage.
15. Do not pull the laterals with force while shifting, rotating / unrolling.
16. Operation of valve should be proper as per the direction given on valve without tampering with the factory setting / assembly.
17. Before any alteration to the system changing the system design, always consult the technical division of the Company or Authorised dealer as the system designed for one crop may not be adequate or suitable for another crop and / or spacing.
18. Do not alter the designed / recommended pump.
19. Do not change the water source without ascertaining the quality of water.
20. To avoid damage, protect the system properly while operating farm machineries in the field or carrying out any manual operation.
21. Roll the laterals properly in coil form while removing the laterals from the field and ensure that no damage is done to GTO while folding lateral-tubes.
22. Don't forget to properly protect, safeguard the installation before burning the previous crop stalk (residue).
23. Use only 100% Water Soluble Fertilizer during fertigation through MIS. Don't use any other type of fertilizer.
24. Do not mix cow dung in suction piping to prevent / stop leakage in the foot valve, instead change rubber flap and / or clean the foot valve strainer properly.
25. For further details refer to the company.

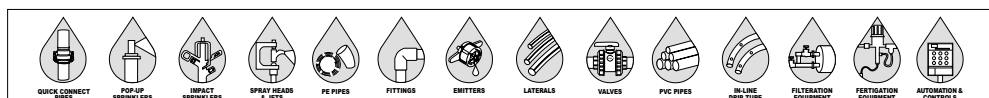



WARRANTY LETTER

Jain Irrigation Systems Ltd. Jalgaon (Hereinafter referred as the company) offers the following warranty for one year from the date of delivery, in respect of the quality of the drip irrigation systems consisting of PVC pipes, Laterals, Drippers, Filters and fittings etc. installed by the "The Company" against the manufacturing defects only.

1. The company undertakes to repair or replace any portion or the entire drip system which were supplied, was originally defective in material or workmanship, if such defects are noticed at the time of laying and jointing of the system, testing or in operation and in any case not later than one year after the date of delivery.

2. The defects if noticed should be reported to the Company within one week of noticing. If the Company is satisfied that the defects are not due to improper usage, neglect, any modifications / alterations done in installation & or design and repair by unauthorized persons etc... then full replacement shall be granted against the return of the defective component to the Company.

3. The repairs or the replacement shall be carried out by the Company or its authorized dealer or representative only.

4. This warranty in no case shall be extended to payment of any monetary consideration and does not

cover any consequential or resulting liabilities, damages, or loss to the purchaser.

5. This warranty does not cover the damage inflicted by acts of god, insects, worms, beetles, crickets, rodents, squirrels, and any other animals / creatures or by miscreants.

6. Though spares and consumables are part of the system, they are not covered under the scope of this warranty.

7. This warranty automatically becomes null & void on expiry of the warranty period.

DISCLAIMER

Liability of Jain Irrigation Systems Ltd., by way of this warranty is solely limited to the original cost of the part or product and will not be responsible for any incidental or consequential damage.

Jain products dealers are independent traders / contractors and not representative(s) or employees of Jain Irrigation Systems Ltd. Jain Irrigation Systems Ltd. will not be responsible for acts of commissions and omissions mis-statements of its dealers.

Jain Irrigation Systems Ltd. reserves the right to re-design or modify its products without incurring further liability.

All disputes would be subject to Jalgaon courts jurisdiction only.

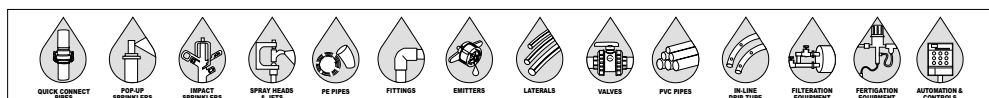



CHAPTER - 10 **POST INSTALLATION : WHAT THE FARMER CAN EXPECT FROM THE COMPANY AND WHAT THE COMPANY EXPECTS FROM THE FARMER**

1. System installation Report :

The purpose of getting the system installation report from the farmer is to ensure whether the company or company's dealer has installed the system on farmer's field as per the design. During installation company's or dealer's representative explains various components of drip irrigation system and their functions to the farmer. In addition to this, detailed information & procedure is explained to farmer regarding back washing of sand filter, cleaning of screen filter, flushing of submains & laterals, maintaining adequate pressure to obtain the rated discharge from system as per the requirement of crops. satisfactory performance given by the system in presence of company's or dealer's representative.

2. Warranty letter :

In this letter, responsibilities of company, Dealer & System owner regarding maintenance of system are clearly mentioned. This letter is furnished in the drafted proforma suggested by Dept. of Agriculture, Maharashtra / respective state and subsidy is released to system owner only after verifying the due signature of company or dealer as authority, and system owner.

It is expected that, farmer should read carefully this letter & then sign, since the problem encountered during the operation of system can be resolved within the framework of this letter.

The better participation of both company and system owner is needed for successful operation and performance of the system as the responsibility of giving successful test operation to the customer rests with the company, further care and maintenance is looked after by customer himself.

3. Free coupon service :

In order to create alertness of maintenance & care of drip system in the customers, company is planning to impart training to customer by regular visit programme. This is to be routed through free service coupons. The purpose of the visit is to give the training on procedure of chemical treatment & related aspect of maintenance of drip system.

The sets of drip system supplied by Jain Irrigation company is serviced thrice on free of cost basis, within nine months from the date of installation. This free service covers actual chemigation to the system as per the quality of water and recommendations prescribed in water analysis report. Even necessary suggestions are also given to the customer for the same.

Customer should avail the free services within the time limit as mentioned above. If services not availed, the service coupon becomes invalid and no further, any kind of compensation is accommodated. In addition to this, system owner remains solely responsible for any type of repairing of the system. In no way company/Dealer is responsible in this matter. Therefore farmers should hand over the free service coupons after filling up necessary information and due signature to the Company/Dealer only after rendering the necessary free services by them.

In addition to free services, system owner could purchase the necessary items or components from the authorised dealer by paying necessary charges.

4. Fortnightly report :

The purpose of furnishing fortnightly report is to ensure whether system owner follows the guidelines given in this guide and to sort out their problem arises, if any, when fortnightly report is submitted, the company utilizes this information as feed back from customer and in future necessary arrangements & planning are made accordingly.

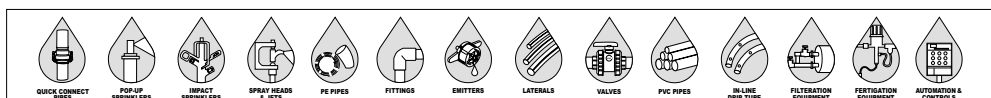



CHAPTER - 11 JAIN DRIP SYSTEM - AFTER SALE SERVICES

We have surveyed your field with maximum accuracy, designed and installed the system and finally commissioned it.

A report signed by the concerned dealer and you, to this effect has been received by us. Moreover necessary guidance to enable you to run the system smoothly, has been given to you by our dealer/officer and signed warranty by you has also been received from you to that effect.

Following instructions are very essential for smooth trouble free operation of your system for a longer period and hence the followings be followed seriously.

1. Before the installation of the system our dealer/representative has described to you the various components of the system alongwith their functional principles. If this is not done so far the same will soon be done.

Over and above this, sand filter backwash, cleaning of sand & screen filter, flushing of main/submains and chemical treatment through ventury taking into consideration the quality of water; all these things have been explained in detail.

2. After installation, three free services alongwith the demonstration will be given by our dealer. Please note that all further treatments are to be done by you. Alternatively we shall do it for you total 4 chemical treatments in the year if you enter into such a contract by paying Rs.1000/- per annum. This fees is valid upto a land-holding of 4 hectares. Spares' replacements, if necessary, will be done at cost.

3. If right care of the followings is taken, your system should be functioning very smoothly. Any kind of negligence on your part & the repercussion of this negligence in maintenance will be totally your responsibility.

The things to be taken care of are :

- Back wash sand filter 5 minutes prior to starting the system
- Clean sand & screen filter regularly.
- Carry on acid/chlorine treatment as recommended either monthly or fortnightly. Acid and Chlorine treatment should never be done simultaneously.
- Even after harvesting or during rainy season do not keep the system permanently off. It is necessary to put - it - on at least for two hours in a week, to flush laterals, submains & clean the filters.

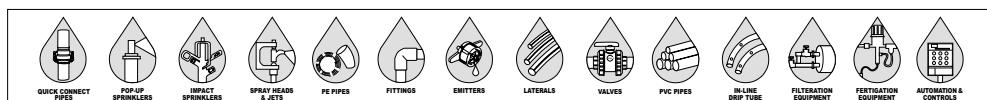



CHAPTER - 11 JAIN DRIP SYSTEM - AFTER SALE SERVICES

If you need to wind the system up, it is necessary to chemically treat it and then wind up and store at such protected place where it is safe from the menace of rats, squirrels etc.

4. Maintaining requisite pressure of the system is very vital as far as distribution of equal predetermined quantity of water to each plant is concerned. The existing pump does not function or malfunction and/or the level of well water further goes down, equal distribution of water due to inadequate pressure may not be possible. This is not the responsibility of the company or dealer.

5. For petty repairs the farmer might need spare parts like joiners, drippers, small quantity of laterals/drip tape, sand for filters, elements of sand and screen filters, acid, chlorine etc. All these are available with our dealers or regional offices.

6. If need be, our engineer/agronomist can personally visit your field for Consultation but each such visit will invite a charge of Rs.300/-

7. Runing the system properly and maintaining it rightly, is solely your responsibility. This includes safety of the system from impacts like mechanical mishaps, invasion by animals like rats, peacocks, Insects, Pests, germs and other life resident in the farm. Company/dealer does not owe any responsibility for damages arising out of the above, and similar such natural calamities.

8. To install a system in a way, that would, cater water to all the plants is company's responsibility. But apart from this-regular use of fertilizers, spraying of Pest/insect killers, regular irrigation and specific cultural practices as per nature of the crop is the responsibility of the farmer and for this the company cannot be even remotely held responsible.

9. If the supplies made by the company have some manufacturing defect the following measures shall be taken.

a. If found faulty the customer should report the matter in writing alongwith the sample of defective component to the dealer or the report to Regional Office or Head Office at Jalgaon.

b. Defective sample will be thoroughly tested and after confirming fully that defect exists, necessary repairs, would be done or defective component replaced. Company's decision regarding what need be done, in such instances, shall be final and mandatory to all parties concerned.

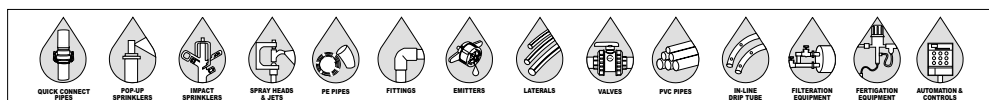



CHAPTER - 11 JAIN DRIP SYSTEM - AFTER SALE SERVICES

c. Company carries no responsibility of any loss arising out of faulty material & warranty does not include faulty material and loss arising thereof. Further the value of faulty material will never be more than its original value.

10. Rules regarding return of material after installation of the system:

- a. PVC-fittings, G.I. fittings will not be taken back.
- b. Lateral less in volume than one bundle will not be taken back.
- c. Material of value less than Rs.750/- will not be taken back.
- d. Sales tax goods sold will not be paid back.

11. In the event of minor problem, it is always convenient to talk to the dealers, or our regional office. Jalgaon Head office may not have adequate background of your problem & hence help may be delayed.

12. Please see that you fill in fortnightly report given along this Guide regularly and send the same to dealer or regional offices so that, help if any needed, can be given conveniently and without delay.

13. While corresponding with the company/dealer please do not fail to mention your file no.

14. Your valuable and just suggestions regarding Drip Irrigation System, will be very seriously considered & we shall do our best to implement them.

If you provide us with a comparative statement in the format no. 8.1, provided herewith regarding the followings; **Company may reward such information.** The information should include yield per acre, expenditure incurred, Water requirements, fertilizers, Labour Cost - before and after the installation of the system. The essential purpose behind this exercise is to acquire greater understanding about drip irrigation, Its maintenance, and various advantages one can have from it.

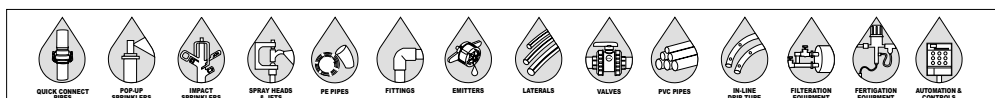



CHAPTER - 11 JAIN DRIP SYSTEM - AFTER SALE SERVICES

Format No. 8.1

File No. : _____ Name of Crop : _____

Area : _____ Expenditure of Drip Irrigation : _____

Date of Installation of the System : _____

Sr.No.	Information	Conventional Method	Drip Irrigation System
A)	Yield of Crop		
1.	Quantity of Water applied from plantation		
2.	Yield (Tonnes/Quintals)		
3.	Selling Price (Rs/Ton.) / (Rs/Q)		
4.	Total Income (Rs.)		
B)	Cost of Cultivation		
1.	Tillage Operations		
2.	Expenses for seed.		
3.	Expenses for Planting		
4.	Expenses for Manures/Fertilizers		
5.	Expenses for insecticides		
6.	Expenses on Labour		
7.	Expenses on Electricity		
8.	Expenses for Maintenance and Supervision		
9.	Other Expenditures		
10.	Total Expenditure		
C)	Total Profit (A-B)		
D)	Interest (if any)		
E)	Net Profit (C-D)		
F)	Investment		
G)	Subsidy		
H)	Net Investment (F-G)		

Farmer's Remark : _____

Signature of the Farmer & Date

Jain Irrigation Systems Ltd., Plastic Park, Jain Fields, P.O.Box 72, Bambhori, Jalgaon 425 001.(Maharashtra); Tel.257-250011/22, Fax : 257-251111/22, Tlx. 753-254 JISL IN, Cable: Jain Drip, E-mail: jisl@jains.com, Internet: http://www.jains.com

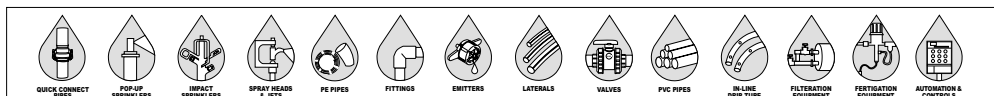



CHAPTER - 12 A WORD OF CAUTION

1. We install the system based on the data provided about the quantity and quality of water available and pump details. In the event of failure of the pump/parts, the design of our drip system will need to be changed to ensure uniform irrigation to all plants.
2. Cleaning the screen filter, backwashing sand filter, flushing of main/submains, laterals and depending upon the quality of water giving chemical treatment at regular intervals are some of the essentials for the proper functioning of the system.
3. In addition to maintenance procedures listed as above, timelines of operations is essential to reach the expected yield from crops. Regularly in irrigation, fertilizer application, pest-control and cultural practices are important attributes to realize the best result of drip irrigation system.
4. In this drip irrigation guide, the reference has been made regarding the needed documents for Subsidy purpose. Moreover the reference is also made regarding installation report, Warranty, fortnightly report & three free services which amounts to train the user, for day to day maintenance of the system. The farmers are therefore advised to scrutinise and process these papers mentioned herein for getting the subsidy.

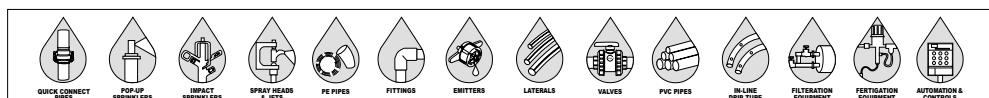



Major advantages of Micro (Drip) Irrigation :

1. Uniformity of water application : All the parts of the land receive the same amount of water and results in saving of water, power, fertilizer.
2. Water placement : The water and nutrients are virtually hand-fed directly into the root of the plant, thus roads and rows between the plants remain dry and has major advantage in harvesting.
3. Improved Disease control : Disease control is enhanced in micro irrigation.
4. Difficult Terrain: Difficult soil terrain condition can be overcome.
5. Water conservation : Water transmission losses are eliminated.
6. Chemical application efficiency: Fertilizer and other chemicals are effectively applied into the root zone where they are needed.
7. Improved tolerance to Salinity : Concentration of salt is reduced and salts are moved away from the plant to the edges of the root zone.
8. Energy: Significantly low operating pressure consumes relatively less energy.
9. Increased field : Soil moisture is maintained at field capacity to achieve maximum yield.
10. Improved Quality: Slow regular and uniform application of water and nutrients result in even growth and ripening, producing a more uniform crop of a more consistent quality.
11. Reduced labour costs: Labour requirements for micro irrigation systems are low because the low application rates allow larger areas to be irrigated to a time, and because these systems lend themselves to automation also to direct savings in labour.
12. Saving in weed control: Saving of upto 35% of cost of weeding is possible because of accurate placement of micro irrigation.

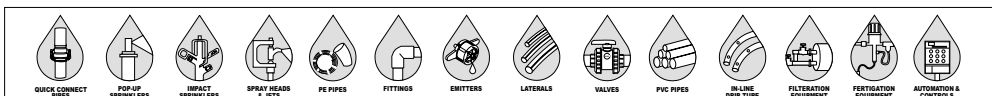



JAIN DRIP / JAIN DRIP TAPE SYSTEM 1/2

INSTALLATION REPORT

Farmer's Name and Address: _____
 Type of the system Installed: _____ File No. _____
 Installation Period _____ Engineer's Name: _____
 Fitter's Name: _____ Crop & Area: _____
 Dealer's Name: _____

1. Did you install the system as per the design and the layout given to you? If no, give details and draw the sketch of the system as installed. Also clearly indicate the material used on the B.O.Q.
2. Why have you made these changes in layout? Give reasons.
3. Did you install sand filter / screen filter correctly?
4. Did you put sand into the sand filter? Did you find shortage of sand?
5. Did you provide bypass arrangement?
6. a) Did you provide extra lateral length pipe for snaking? b) How deep did you install the Jain Drip Tape/Turboline tubings?
7. Did you flush the main, submain, lateral after connecting? Did you flush the lateral before connecting drippers?
8. a) How many drippers are used per plant? At what distance? b) What is the type of drippers used? Discharge?
9. How much pressure did you get at the inlet of filter?
10. How much pressure did you get at the inlet of submain?
11. a) Did you measure the discharge of the dripper? (Measure the discharge of the dripper at 6 places i.e. at the start, middle and at end.) b) In case of Jain Drip Tape/Turboline did you observe the soil wetting pattern? How is it ?
12. Is the measured discharge equal to the discharge for which system is designed? If not, what are the probable reasons?
13. Did you find any leakage in the system? If so, why?

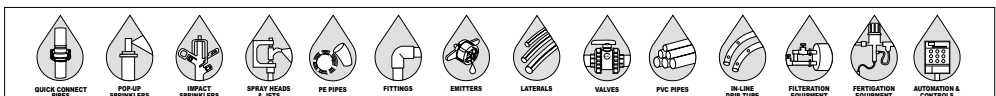



JAIN DRIP / JAIN DRIP TAPE SYSTEM 1/2
INSTALLATION REPORT

14. Did you explain to the farmer regarding the following?
a) How to operate the system!
b) How to backwash sand filter! When? And the importance?
c) When and how to flush submain, Laterals/ Biwalls /Cane wall Jain Drip Tape/Turboline & its importance
d) Did you demonstrate how to connect & use fertilizer tank/ ventury? How to apply chemicals & fertilizers.
e) Have you told farmer the importance of maintenance & proper operation of the system?
f) Have you explained him the customer policy?
1. Only first three chemical treatments will be given free.
2. Later on farmer has to do his own. Otherwise he has to bear charges for the company person's visit for chemical treatment or other purpose regarding manufacturing defects.
g) Have you explained to him thoroughly our warranty regarding manufacturing defect? His responsibility for proper operation & maintenance of system. Mechanical damage due to rats, squirrels during ploughing etc.
h) Have you given him the idea about water requirement at different stages & how many hours to run the system?
15. Have you purchased any material from out side? Give details with bills. Who has paid this bill?
16. Have you obtained a copy of B.O.Q. signed from the farmer towards the receipt of the material as used actually?
17. Give the remarks for the installed system.
18. Is the installation incomplete in any respect?
19. Did you receive the material as per B.O.Q.? Is it as per the installation Drawing?

Signature of Dealer : _____ **Signature of the Installation Engineer:** _____

Your Shri. _____ has installed Jain Drip / Biwall / Canewall (Jain Drip Tape) Irrigation system and the same has been commissioned today. The work is complete in all respects and a trial was also given. The system is functioning satisfactorily. He has explained us about customer policy and our responsibility about proper operation, maintenance, chemical treatment and mechanical damages due to rats, squirrels or other sources. There is no complaint from our end. Installation work took _____ days.

Farmer's Signature

and Date

JAIN IRRIGATION SYSTEMS LTD., Jain Fields, P.O.Box 72, Bambhori, Jalgaon 425 001. (Maharashtra);
Tel.257-220022, Fax : 257-221122, Tlx. 753-254 JISL IN, Cable: Jain Drip.

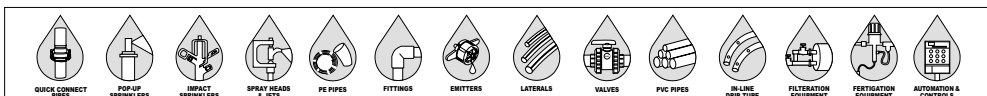



WARRANTY LETTER 1/2/3

We _____ (State Govt. approved Supplier/Distributor of Micro Irrigation System) have installed the Micro Irrigation System on _____ as per the details given below :

- 1) Name and address of the farmer : _____
- 2) File Number : _____ 3) Crop : _____ 4) Area: _____
- 5) System type : _____ 6) Invoice Date: _____ 7) Invoice Amt.(Rs): _____
- 8) Invoice No. : _____

We have supplied the system as per the specifications laid down by the Government. We herein give the warranty against the manufacturing defects for a **period of five years**. We promise to repair or replace any part found to have manufacturing defect during the warranty period of three years from the date of Installation, free of cost whereas for the fourth and fifth year, the cost of the part having manufacturing defect will be charged at 25% and 50% of their market price respectively. However, no separate charges for the visit of the company representatives need to be paid during this period for manufacturing defects only.

This warranty in no case shall extend to payment or any monetary consideration and does not cover any consequential or resulting liability, damages or loss to the farmer. Spares and consumables such as valves, fittings and accessories required for day to day maintenance are not covered under the scope of the warranty letter. During the warranty period of 5 years if required by the farmer, maintenance service will be provided on chargeable basis.

For smooth performance of the system during the warranty period Company's and or their Distributor's responsibility shall be limited to :

- 1) Designing of the system based on the topographic survey, soil and water analysis, climatological data, type of the crop to be grown.
- 2) Designing of the system to get the required pressure and discharge of water by considering the existing pump details and depth of water from the available source.
- 3) Providing the necessary installation-cum-maintenance manual.
- 4) Providing Three free-Post Installation services for practical instruction of maintaining the system.

Whereas during the warranty period, the farmer will be responsible for :

- 1) Regular and periodical cleaning of the filters as per the instructions.
- 2) Regular and periodical flushing of the system.
- 3) Regular running of the system is essential for maintaining field capacity condition and for avoiding consequential problems.
- 4) Following the guidelines given in the maintenance-cum-installation manual of the company.
- 5) Regular and periodic acid and chlorine treatment required for avoiding the algae, clogging and salt formation.
- 6) Prevention of the system from the mechanical and physical damages and also from animals, insects and theft.
- 7) Adhering to original installation and design given by the company if any alteration or addition is to be made then the same should be done only after approval from the Company or their Distributor or by their Authorised Representative.

If, during the performance period of warranty letter, any dispute is arised, then the same will be referred to the Director of Horticulture/Agriculture who will be the sole arbitrator and decision given by him will be binding on both the parties.

Signature of the farmer

Date:

Place: _____

Signature of the Manufacturer/Dealer

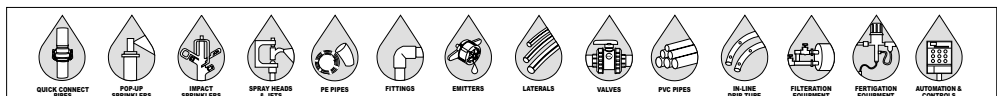



DRIP IRRIGATION SYSTEM FREE SERVICE NO. 1/2/3

Date: _____ Coupon No.: _____

1) Name of the Farmer and address : _____

2) File No : _____ 3) Date of System Installation: _____

4) Bill No.: _____ Date : _____ Sum of Rs.: _____

5) Crop : _____ 6) Area : _____

7) Type of System: _____

8) Name of Dealer /Distributor : _____

9) Name of the Service Engineers/Representative : _____

10) Services Rendered : _____

- a) Checked and Cleaned Sand & Screen Filter : Yes / No.
- b) Chemical Treatment Carried out (Acid/Chlorine) : Yes/ No.
- c) Flushed the main/submain & Laterals and checked the pressure: Yes/ No.
- d) Checked the discharge of drippers: Yes/ No.

11) Additional Repairs done as follows :

- a) _____
- b) _____
- c) _____

12) Remarks of the Farmer : _____

13) Remarks & Suggestions of the Company/Dealer's/Distributor's Representative : _____

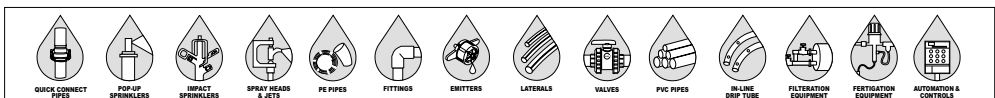



DRIP IRRIGATION SYSTEM FREE SERVICE NO. 1/2/3

Your representative has explained to me the operation of the system, its maintenance and how to carry out chemical treatment and its importance. I have thoroughly understood this. Hereafter I shall maintain the system carefully and shall be responsible for any damage arising due to negligence on my part or menace due to ants, rats, squirrels etc. The drip irrigation system on my farm is functioning satisfactorily and I do not have any complaint about it.

Signature of the representative of Company/Dealer_____.

Signature of the Farmer with date:_____.

Recorded in Regional Office and hence sum of Rupees _____ (In words Rs. _____ towards the services)

Approved for Payment : Yes / No.

Signature of Regional Manager

Important Suggestions for free service:

- 1) Three free services are given to the Jain Drip Customer. First service must be given within three months of Installation. Then second service should be given after three months from the Date of first service. Same thing is to be followed in case of third service. The farmer should inform dealer from whom he has purchased the system, on which date he wants the service.
- 2) These free services include the following services also -
 - a) Complete inspection of the drip irrigation system.
 - b) Repairs of leakages.
 - c) Cleaning of Filter, laterals, main, submain lines & screen of the filter. If sand filter is also there then, Sand is to be cleaned and added if needed.
 - d) Checking of the Drippers & giving chemical treatment.
 - e) After studying the irrigation given by farmer, guide him whether to increase or decrease the quantity of water to be given to the crop.
 - f) Training the customer about running & maintaining drip irrigation system.
 - g) Farmer must avail the free services within the specific period only. Otherwise he will not be able to utilise the coupons & no compensation will be paid to him. Besides, the farmer will be totally responsible for the repairs and maintenance of the system. Company/Dealer/Distributor will not be responsible for this.
- 3) Farmer should fill the information in the coupons and hand over to representative of the Company/Dealer/Distributor.

Jain Irrigation Systems Ltd., Plastic Park, Jain Fields, P.O.Box 72, Bambhori, Jalgaon 425 001.(Maharashtra); Tel.257-250011/22, Fax : 257-251111/22, Tlx. 753-254 JISL IN, Cable: Jain Drip, E-mail: jisl@jains.com, Internet: http://www.jains.com

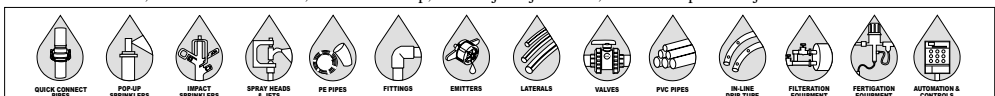



JAIN DRIP FORTNIGHTLY REPORT

1. Do you give backwash to the sand filter? Daily/two days interval/once in a week?
2. Pressure at the inlet of sand filter? Pressure at the outlet of sand filter?
3. During backwash do you find soil particles, Algae, waste material/sand etc.?
4. Does Screen filter choke-up?
5. How many times screen filter is cleaned?
6. Does pipeline, fittings, filter etc. leak?
7. Do you clean submains? After how many days? Do you find any waste particles, dirty water at the time of cleaning submain? Last date of cleaning of submain:
8. A. Do you clean laterals/Drip tape? After how many days? B. Do you find any waste particles, dirty water, algae etc. at the time of cleaning? C. Last date of lateral cleaning
9. Is discharge from all drippers uniform?
10. How much is the discharge from the drippers, what is your opinion about getting uniform discharge from all the drippers?
11. Does filter, laterals/Drip tapes, drippers, valves etc. work without failure?
12. Does fertilizer tank or ventury work effectively?
13. What is your opinion about Jain drip, regarding water use, plant growth, quality improvement & increase in yield
14. Do you need any guidance from us?
15. To avoid choking, do you give chemical treatment as per recommendations given in water analysis report? Date of last Chemical treatment.
16. Last date of visit of company's/Dealer's Engineer, Agronomist or fitter ?
17. Does system work effectively & without any problem?

Note: Please maintain a register in this format and update fortnightly.

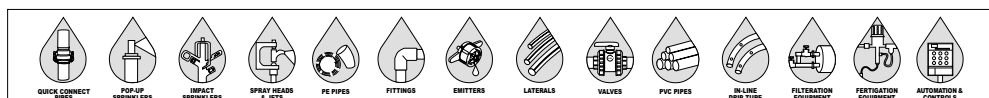



JAIN DRIP FORTNIGHTLY REPORT

Report No.: _____ File No.: _____ Date: _____
 _____ Farmer's name: _____ Tal.: _____
 _____ Dist.: _____
 Date of System installation: _____ Crop: _____ A r e a : _____

Sr. No.	Date	System Run hours	Pressure (Kg/Cm ²)		Dripper discharge in Litres Per hour	Remark
			At Filter inlet.	At Submain inlet.		
1.						
2.						
3.						
4.						
5.						
6.						
7.						
8.						
9.						
10.						
11.						
12.						
13.						
14.						
15.						

SPECIMEN COPY

Please write answers of the following questions, in the space provided in right hand side. A register should be maintained at the farm in this format and undate fortnightly. This will help us to serve you better in future.

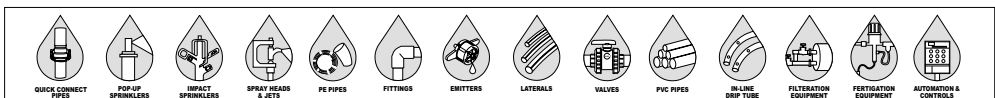



NOT JUST IRRIGATION COMPONENTS BUT FARMING CONCEPTS

A Total System Approach : In a world of ever increasing input costs and diminishing natural resources, the efficient utilization of energy, water, nutrients and soil is vital. Jain Irrigation has long before recognised this need and developed irrigation products and systems which minimise water use, maximise yields and improve quality of the produce. This technology can make good use of even poor quality water and soils.

Jain Irrigation is the largest manufacturer of Micro Irrigation Systems in India. We believe that our diverse and wide range of products, supported with continuing innovations and stringent quality standards demonstrate our deep commitment to excellence.

In addition to manufacture and supply of the necessary components for the cost effective yet most efficient Micro Irrigation Systems, Jain Irrigation also takes turnkey jobs offering complete support including system planning, design, installation after sales, agronomical and technical services. Today, Jains also buy what the farmers produce. Thus Jain supply the inputs and purchase the output-a completely integrated approach. The Company has developed a vast marketing network throughout the country and abroad, also reservoir of human resources : agricultural engineers; agronomists; horticulturists; technicians and agriscientists.

Each system is tailor made taking into account the different crops, specific water requirements, soil type, temperature and humidity, and the water quality. All these factors are weighed with reference to available resources. The result is a completely tailor made system that is engineered for reliable operation and installed on turnkey basis to the precise specifications and needs of each field, farm and farmer. And that makes a world of difference!

We are the pioneers of such an integrated and comprehensive approach in the field of Micro Irrigation in India. And in just 9 years we have set up a global marketing network that covers over 30 countries today. This very approach has helped our products and services succeed in some of the world's most advanced markets.

Jain Irrigation Systems Ltd.

Jain Plastic Park, N. H. No. 6, P.O. Box: 72, Bambhori, Jalgaon - 425 001. India.

Tel: +91-257-250011/22, Fax: +91-257-251111/22,

Visit us at: <http://www.jains.com>

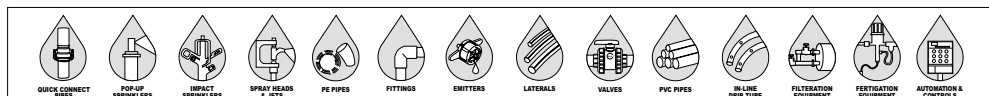



Jain Fields - Plastic Park, Jalgaon. Maharashtra (India)

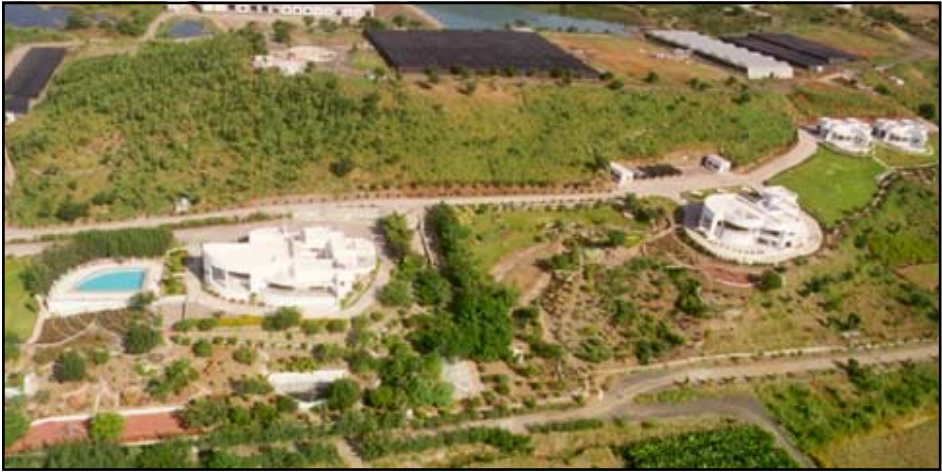

Jain Hills - Agri Park, Jalgaon. Maharashtra (India)



Jain Valley - Food Park, Jalgaon. Maharashtra (India)

Jain Irrigation Systems Ltd.

Jain Plastic Park, P.O.Box: 72, N.H. No.6, Jalgaon - 425 001. (India)
Tel: 0257-2250011/22; Fax: 0257-2251111/22
Internet: <http://www.jains.com>