

# Earth/ground measurement guide



# Earth/ground\* resistance measurement

One of the basic prerequisites for guaranteeing safety on any residential or industrial electrical is to provide an earth electrode.

If there is no earth/ground electrode, people's lives may be endangered and electrical installations and other property may be damaged.

An earth/ground electrode alone, however, is not enough to guarantee total safety. Only regular inspections can prove that the electrical installation is operating correctly.

There are many earth resistance measurement methods available, depending on the type of neutral system, the type of installation (residential, industrial, urban environment, rural environment, etc), the possibility of cutting off the power supply, etc.

## Why is earthing necessary?

Earthing means setting up an electrical bond between a given point in a network, installation or machine and an earth electrode. This earth electrode is a conductive part which may be inserted in the ground or in a conductive medium, in electrical contact with the Earth (see definition in NFC 15-100).

Earthing thus involves using a wire conductor to connect an earth electrode to the metal chassis earths which might accidentally come into contact with the electric current due to an insulation fault on an electrical device. In this way, there will be no danger for people because the fault current will have drained into the earth. If there is no earthing, any person involved will be subjected to an electric current which may kill them, depending on its level.

Earthing therefore enables leakage currents to flow away safely and, if it is linked to an automatic cut-off device, can ensure that the power supply to the electrical installation is switched off. So correct earthing keeps people safe while also protecting installations and property if there are fault currents or lightning strikes. It should always be linked to a cut-off system.

### Example:

If the insulation on the load is faulty, the fault current is drained to earth via the protective conductor (PE).

Depending on its value, the fault current may cause the installation to be cut off when the residual current device (RCD) is tripped.

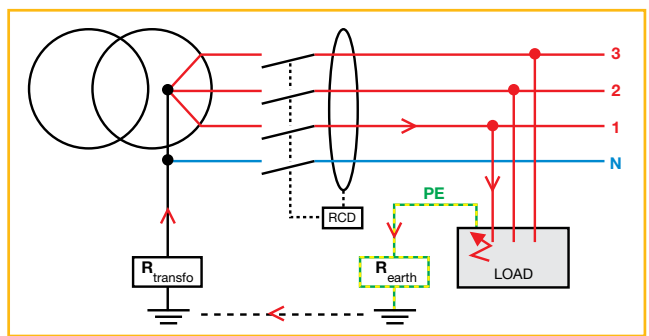

## What should the value of the earth resistance be?

Before starting any earth resistance measurements, the first thing you need to find out is the acceptable maximum value for correct earthing.

The earth resistance requirements vary according to the country, the neutral systems used and the type of installation. For example, a power distributor such as EDF will require an extremely low earth resistance, often of only a few ohms. So it is important to check beforehand on the standards applicable to the installation to be tested.

### As an example, let's take a TT residential installation in France:

To keep people safe, an installation must be equipped with protective devices which trip as soon as a "fault voltage" flowing in the installation exceeds the threshold voltage liable to harm the human body. Studies by a working party of doctors and safety experts have determined a permanent contact voltage accepted as safe for people: 50 V AC in dry premises (the limit may be lower for humid or immersed environments).

Furthermore, in residential installations in France, the residual current device (RCD) linked to the earth electrode usually allows a current up to 500 mA.

According to Ohm's Law:  $U = RI$

In this case:  $R = 50 \text{ V} / 0.5 \text{ A} = 100 \Omega$

To make sure there is no danger for people or property, the resistance of the earth electrode must be less than 100 Ω.

The calculation above clearly shows that the value depends on the rated current of the RCD controlling the installation.

For example, the correlation between the earth resistance and the RCD rated current is specified by the NF C 15-100 standard, as shown in the following table:

Maximum resistance of earth electrode according to RCD rated current

	Maximum rated current of RCD (I <sub>Δn</sub> )	Maximum resistance of earth electrode for chassis earths (Ohms)
Low sensitivity	20 A	2.5
	10 A	5
	5 A	10
	3 A	17
Medium sensitivity	1 A	50
	500 mA	100
	300 mA	167
	100 mA	500
High sensitivity	≤ 30 mA	> 500

\* To simplify, we will use the term "earth" in the text that follows.

## What is an earth electrode made up of?

### The earth electrode

There are various methods for setting up an earth electrode, depending on the country, the building regulations and the applicable standards. In France, the following types are used:

- underground earth loop
- metal strip or cable sunk into the blinding concrete
- plates
- stakes or tubes
- ribbons or wires.
- etc.

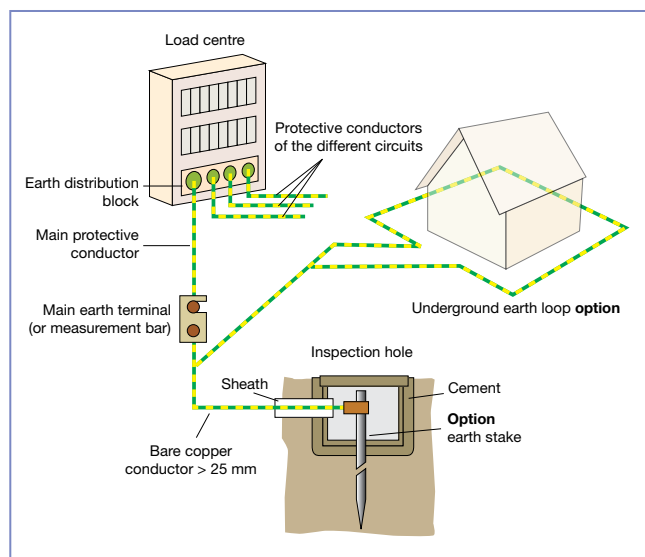

Whatever the type of earth electrode chosen, its purpose is to remain in close contact with the soil so that it can provide a connection with the earth to drain any leakage currents. The quality of an earth electrode depends on three key characteristics:

- the type of earth electrode
- the earth conductor
- the type and resistivity of the terrain, which is why it is important to measure the soil resistivity before installing new earth electrodes.

### Other elements

The entire earthing system of the building is set up around the earth electrode. The earthing system usually comprises the following elements: the earth conductor, the main earth terminal, the measurement bar, the protective conductor, the main equipotential bond and the local equipotential bond.

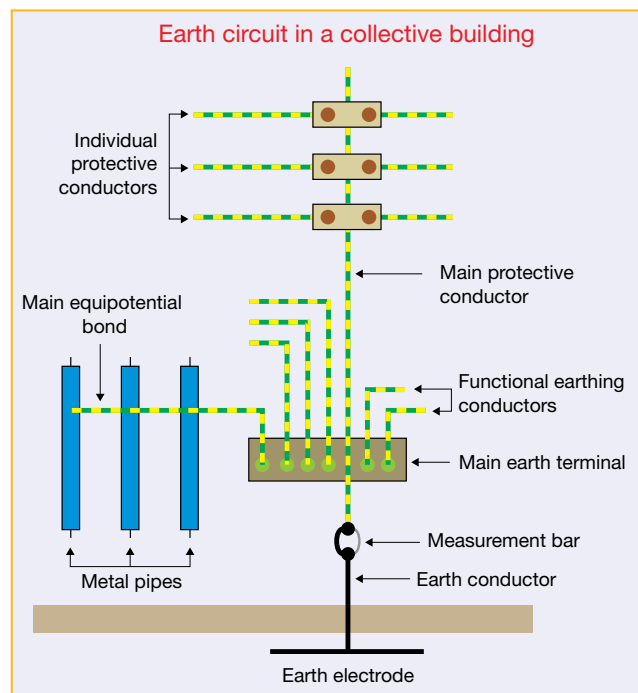

### Soil resistivity

Soil resistivity ( $\rho$ ) is expressed in Ohm metres ( $\Omega \cdot m$ ). This corresponds to the theoretical resistance in Ohms of a cylinder of earth with a cross-section area of  $1 \text{ m}^2$  and a length of 1 m. By measuring it, you can find out how well the soil conducts electric currents. So the lower the resistivity, the lower the earth electrode resistance required at that location.

Resistivity varies significantly according to the region and the type of soil because it depends on the level of humidity and the temperature (frost or drought increase it). This is why earth resistance may vary according to the season or the measurement conditions. As temperature and humidity levels become more stable the further you go from the ground surface, the deeper the earthing system, the less sensitive it is to environmental variations. **It is advisable to bury your earth electrode as deep as possible.**

#### Seasonal variation of earth resistance

(Earthing: electrode in clay soil)

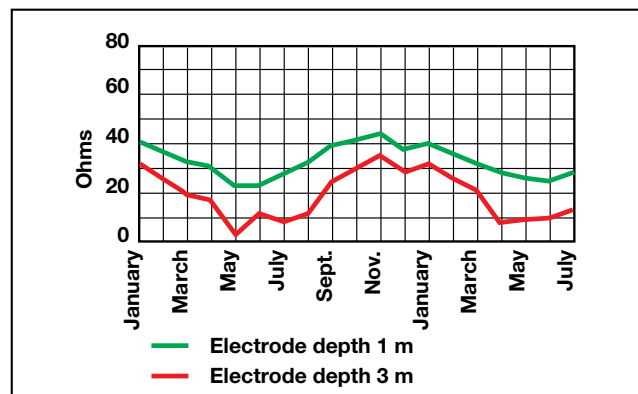

## Resistivity according to type of terrain

Type of terrain	Resistivity (in $\Omega.m$ )
Marshland	from a few units to 30
Loam	20 to 100
Humus	10 to 150
Jurassic marls	30 to 40
Clay sand	50 to 500
Silica sand	200 to 3,000
Bare stony ground	1,500 to 3,000
Grass-covered stony ground	300 to 500
Soft limestone	100 to 300
Fissured limestone	500 to 1,000
Mica schist	800
Decomposing granite and sandstone	1,500 to 10,000
Highly-decomposed granite and sandstone	100 to 600

### Why soil resistivity measurements are useful

Soil resistivity measurements help you to:

- Choose the locations and types of the earth electrodes and earth networks before building them
- Define the electrical specifications of the earth electrodes and earth networks
- Optimize the construction costs for the earth electrodes and earth networks (the required earth resistance is obtained more quickly).

As a result, they are used on construction sites or for large-scale tertiary buildings (or power distribution substations) where it is important to choose the best positions for the earth electrodes.

### Methods for measuring soil resistivity

Several processes are used to determine soil resistivity. The most widely used involves "4 electrodes", with two possible methods:

- **WENNER** method suitable for measurements at a single depth
- **SCHLUMBERGER** method suitable for measurements at different depths, as required for geological soil profiles.

### Wenner method (most common)

#### Measurement principle

Four electrodes are set up in line in the ground, equally spaced at a distance "a" from one another.

A generator is used to inject a measurement current "I" between the two outer electrodes (E and H).

The potential  $\Delta V$  is then measured with a voltmeter between the two central electrodes (S and ES).

The measurement instrument used is a traditional earth ohmmeter capable of injecting the current and measuring the  $\Delta V$  value.

The resistance value **R** read on the ohmmeter can be used to calculate the resistivity by applying the following simplified formula:

$$\rho = 2 \pi a R$$

Where  $\rho$  is the resistivity in  $\Omega.m$  at the point located under point O, at a depth of  $h = 3a/4$

**a** is the measurement base in m

**R** is the value (in  $\Omega$ ) of the resistance read on the earth ohmmeter

For these measurements, EDF recommends that distance "a" should be at least 4 m.

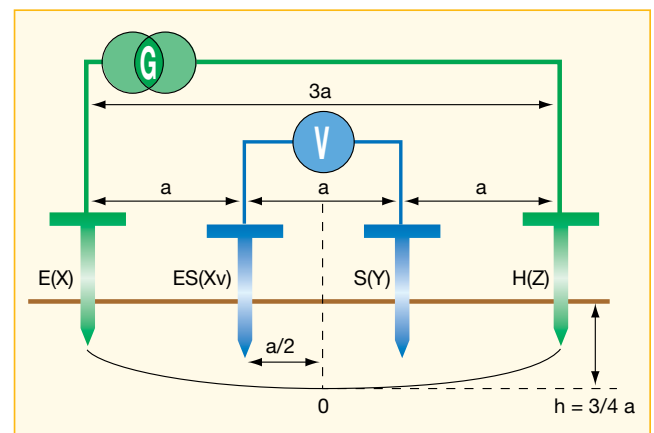

Note: the terms X, Xv, Y and Z correspond to the former naming conventions used for the E, Es, S and H electrodes, respectively.

### Schlumberger method

#### Measurement principle

The Schlumberger method is based on the same measurement principle. The only difference concerns positioning of the electrodes:

- the distance between the 2 outer stakes is 2d
- the distance between the 2 inner stakes is A

and the resistance value **R** read on the ohmmeter can be used to calculate the resistivity with the formula:

$$\rho_S = (\pi \cdot (d^2 - A^2/4) \cdot R_{S-ES}) / 4$$

This method saves considerable time in the field, particularly when you want to carry out several soil resistivity measurements for a profile of the terrain. The extra time saved is due to the fact that only the 2 outer electrodes need to be moved, whereas all 4 electrodes need to be moved at the same time with the Wenner method.

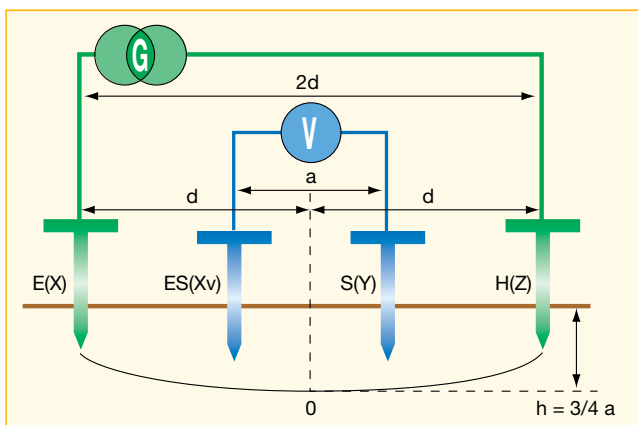

Although the Schlumberger method saves time, the Wenner method is better known and more widely used. The mathematical formula necessary is also much simpler. Nevertheless, many Chauvin Arnoux measurement instruments include both formulae for instant calculation of the resistivity values with either method.

## Methods for measuring earth resistance on an existing earth electrode

### The different methods:

The soil resistivity measurement methods presented so far can only be used when installing a new earth electrode: they can be used to check the resistance value in advance and adjust the electrode according to the earth value required. For existing earth electrodes, the method involves checking that they comply with the safety standards in terms of their construction and resistance value.

Various measurement methods may be used, however, depending on the installation's characteristics: whether it is possible to cut off the installation's power supply or disconnect the earth electrode, whether the electrode to be tested is the only one or is connected to others, what level of measurement accuracy is required, where the installation is located (urban or rural environment), etc.

### Earth resistance measurements on installations with a single earth electrode

It is important to point out that the earth resistance measurement of reference is the 2-stake method. This method is referenced in all the electrical installation testing standards and can be used to measure the earth resistance both accurately and safely.

The measurement principle involves using an appropriate generator **G** to inject an alternating current (*i*) through the auxiliary electrode **H** and back through the earth electrode **E**.

The voltage **V** between the earth electrode **E** and the point in the earth where the potential is zero is measured using another auxiliary electrode **S**. The resistance can then be calculated by dividing the voltage measured by the constant current injected (*i*), thus:

$$R_E = U_{ES} / I_{EH}$$

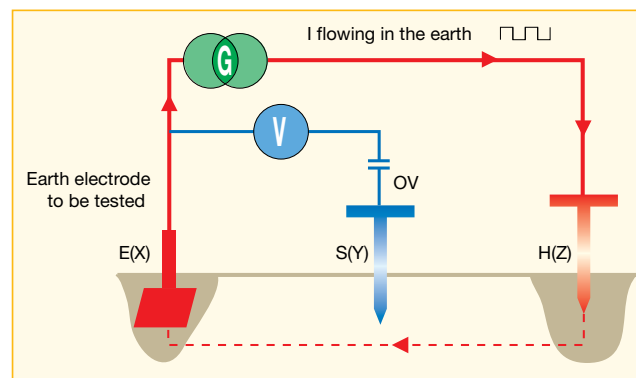

### Important note:

A fault current is initially drained via the contact resistances of the earth electrode.

As you move further away from the earth electrode, the number of parallel contact resistances tends towards infinity, constituting an equivalent resistance close to zero. Beyond this limit, whatever the fault current, the potential is zero. This means that around each earth electrode, there is a zone of influence whose shape and size are unknown.

When measuring, take care to set up the auxiliary electrode **S** (0 V potential electrode) outside the zones influenced by the auxiliary electrodes through which the current (*i*) is flowing.

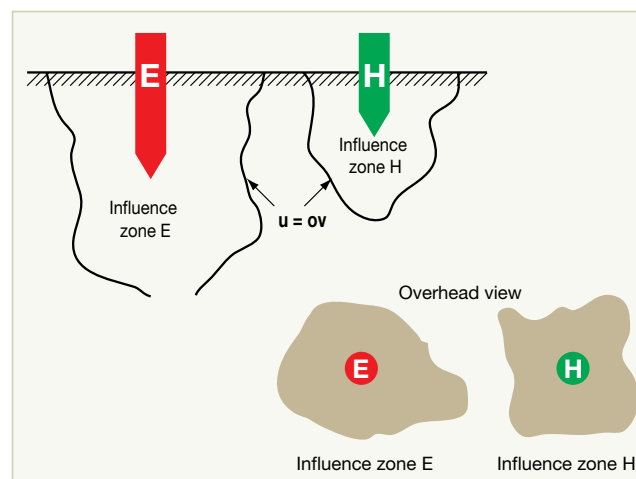

As diffusion of an electric current depends on the soil resistivity, it is difficult to be sure that the zones of influence have been avoided. The best way of confirming the measurement is therefore to repeat it after moving the stake **S** so that you can make sure it is similar to the earlier measurement.

### 3-pole measurement method (62 % method)

This method requires the use of two auxiliary electrodes (or "stakes") to inject the current and to provide the 0 V potential reference. The positioning of the two auxiliary electrodes in relation to the earth electrode to be measured E(X) is crucial.

For correct measurement, the "0 V potential auxiliary electrode" must not be set up in the zones of influence of the earths E & H caused by the current (i) flowing.

Statistics from the field have shown that the best method for ensuring high measurement accuracy is to place stake S at a position 62 % of the distance from E on the straight line EH.

You then need to make sure that the measurement does not vary or only varies slightly when stake S is moved by  $\pm 10\%$  (S' and S'') on either side of its initial position on the line EH.

If the measurement does vary, it means that (S) is in an influence zone, so you must increase the distances and then repeat the measurements.

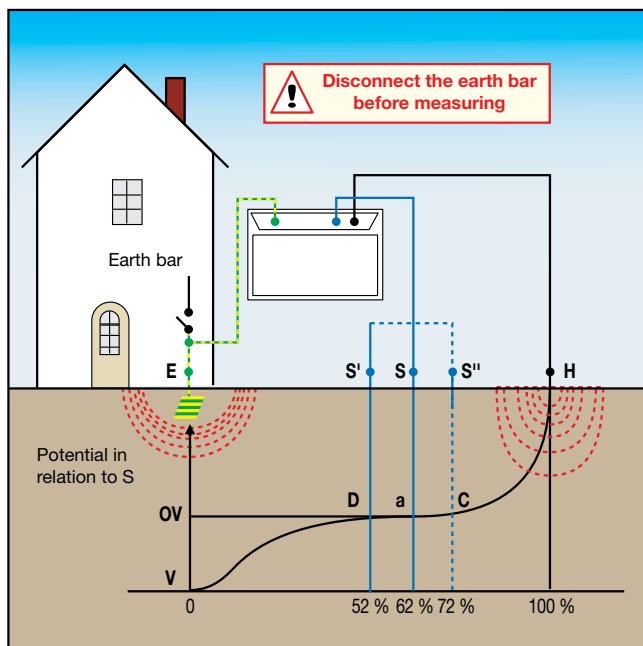

Example: Measurements at different distances R1 to R9 from 10 to 90 % of the distance SH

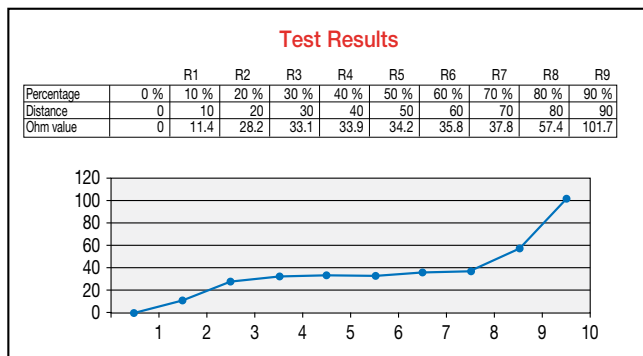

### The triangle measurement method (two stakes)

This method requires two auxiliary electrodes (stakes). It is used when the method described above is not suitable (alignment not possible or obstacle preventing a sufficient distance from H).

It involves:

- Setting up the stakes S and H so that the earth electrode E and the stakes S and H form an equilateral triangle
- First measuring with S on one side and then measuring with S on the other side.

If the values found differ significantly, it means stake S is in a zone of influence. You must then increase the distances and repeat the measurements.

If the values obtained are within a few percent of one another, the measurement can be considered valid.

The results of this method may be uncertain, however, because even when the values found are similar, the zones of influence may overlap.

To make sure, repeat the measurements after increasing the distances.

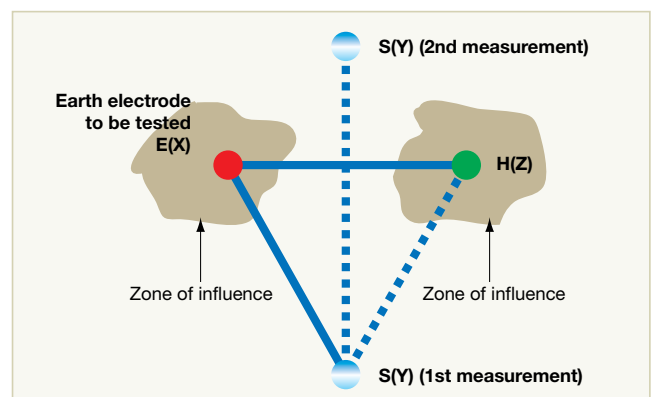

### 4-pole earth resistance measurement method

The 4-pole earth resistance measurement method is based on the same principle as 3-pole measurement, but with an additional connection between the earth to be measured E and the measurement instrument. This method offers better resolution (10 times better than the 3-pole method) and means that the resistance of the measurement leads no longer needs to be taken into account.

This function is ideal for measuring very low earth resistance values, so it is particularly prized by power transmission and distribution companies who need to measure earth resistance values of just a few Ohms.

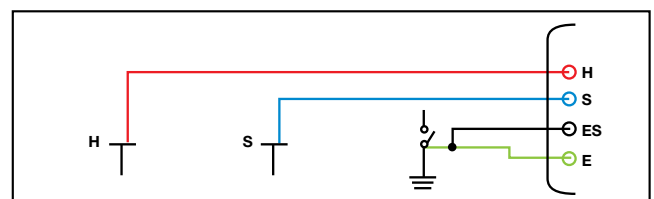

## Note: Opening the earth bar

The advantage of 3-pole and 4-pole earth resistance measurements is that they can be performed on an installation with the power off, so the earth can be tested even if the house or building involved has not yet been connected to the power distribution network or has been disconnected from it.

For these two types of measurement, you are advised to open the earth bar in order to isolate the earth electrode to be measured, thus making sure that the earth resistance measured really is the resistance of the earth electrode. Otherwise, there may be a de facto bond between the earthing installation and an earth electrode due, for example, to the metal ducts of a water or gas distribution network. Earth resistance measurements with the bar closed will then be incorrect due to the presence of this de facto earth electrode. This may lead to an excessively high earth resistance value later on (if a metal duct is replaced with an insulating material, for example). Consequently, unless you are sure that there is no de facto earth electrode, you must open the earth bar for any earth resistance measurements.

To detect any de facto earth electrodes, it may be useful to measure the earth electrodes with the bar open and with the bar closed so that you can check whether the "closed-bar" value is due to the installed earth electrode or to de facto earth electrodes.

**⚠ Only disconnect the ground on de-energized networks**

## The variant 62 % method (one stake)

(only on TT or impedant IT systems)

This method does not require disconnection of the earth bar and only one auxiliary stake (S) is necessary.

With this method, the earthing system of the distribution transformer acts as the H stake and the PE conductor accessible on the protective conductor (or earth bar) acts as the E stake.

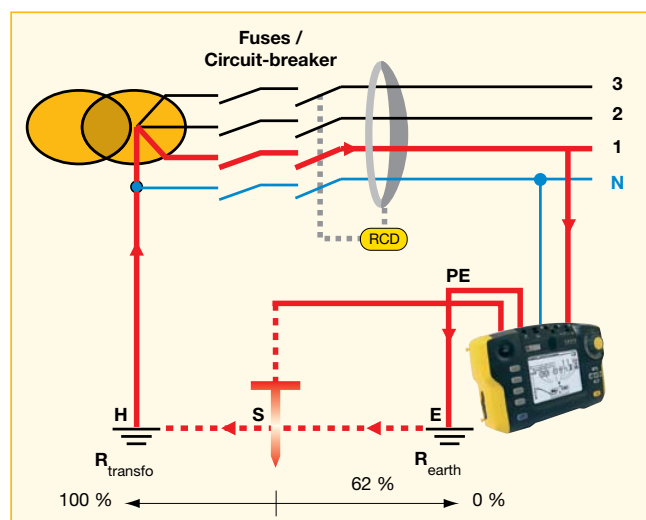

The measurement principle is the same as for the normal 62 % method.

The S stake will be positioned so that the distance S-E is equal to 62 % of the total distance (distance between E and H).

As a result, S will normally be located in the neutral "0 V reference earth" zone.

The earth resistance is calculated by dividing the measured voltage by the current injected.

Differences compared with the normal 62 % method:

- The power supply for the measurement comes from the mains instead of from batteries.
- A single auxiliary stake is required (stake S) so the measurement can be set up more quickly.
- It is not necessary to disconnect the building's earth bar. This also saves time and makes sure that safety is maintained on the installation during measurement.

## Phase-PE loop measurement

(only on TT systems)

In urban environments, it is often difficult to measure earth resistances with methods using stakes because it is impossible to set up the stakes for reasons of space, concreted areas, etc. For this reason, the standards for electrical installation testing allow measurements by the loop impedance method if it proves impossible to use stakes.

*Cf IEC 60364-6: "NOTE: if it is not possible to measure  $R_A$ , this measurement can be replaced by a fault loop measurement as in a) 1)."*

So loop measurement can be used for earth resistance measurements in urban environments without stakes, simply by hooking up to the power supply network (mains socket).

The loop resistance measured in this way also includes the earth and internal resistance of the transformer and the cable resistance, in addition to the earth to be measured. As all these resistances are very low, the value measured is an earth resistance value by excess or overall earth resistance value.

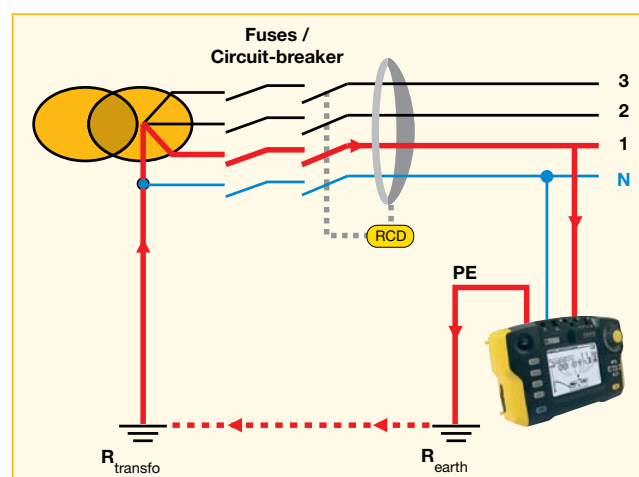

The real earth resistance value is therefore lower:

**$R_{\text{measured}} > R_{\text{earth}}$**

*Note: On TN or IT (impedant) systems, loop impedance measurement can be used to calculate the short-circuit current for correct sizing of the protective devices.*

## Earth resistance measurements on networks with multiple earthing systems in parallel

Some electrical installations have multiple earthing systems in parallel, particularly in countries where the earth is "distributed" to each user by the power supplier. In addition, on sites equipped with sensitive electronic equipment, a grid of earth conductors connected to multiple earth electrodes is used to obtain a totally equipotential floorplan. For this type of network, selective earth resistance measurements help to optimize safety and speed up testing.

All the earth resistance measurement methods reviewed so far can be used for measurements on a single earth electrode. For this reason, if the earth electrode comprises several parallel earths, it will be impossible to isolate and measure each earth separately, so only the equivalent resistance with all the earths in parallel will be measured. The only other solution would involve disconnecting each earthing system in order to isolate the earth to be measured, but that would be long and tiresome.

For this type of installation, which is frequently used in industry, selective earth resistance measurements are carried out with one or more current clamps. There are 2 types of selective measurements: with and without stakes.

All the selective earth resistance measurement methods:

- Save considerable time because it is not necessary to disconnect the earth resistance to be tested from the rest of the earth network. By using a clamp, you can measure the current flowing through the earth electrode tested, thus bypassing the influence of the parallel earth electrodes.
- Guarantee the safety of the people and property in contact with the electrical installation because the earth is not connected.

## Selective 4-pole earth resistance measurement

When a classic 3-pole or 4-pole measurement method is used on a system with parallel earthing, the measurement current injected into the system is divided between the different earths. This means it is impossible to determine the amount of current in a given earth electrode, so its resistance cannot be determined either. In such cases, it is the total current flowing in the earthing system which is measured, giving the overall earth resistance equivalent to the resistances of all the earth electrodes set up in parallel.

To neutralize the influence of the parallel earth electrodes, there is a selective variant of the 4-pole measurement method. The principle is the same except that a current clamp is added to measure the exact current flowing in the earth to be measured, so that its precise value can be determined.

Due to the use of auxiliary stakes and more particularly the 0 V reference with the S stake, this method ensures accurate measurement of the earth resistance.

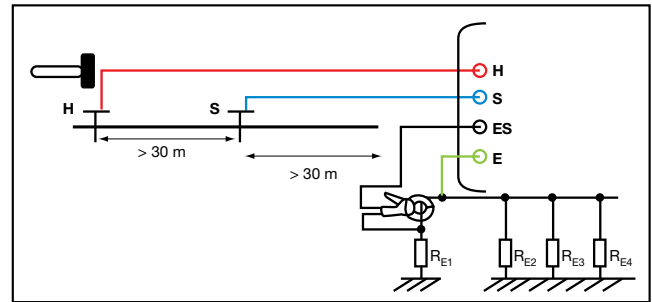

## Earth loop measurement with 2 clamps and measurement with an earth clamp

### Measuring without disconnecting the earth bar and without earth stakes

These measurement methods have revolutionized "traditional" earth resistance measurements: like selective 4-pole measurement, these 2 methods do not require disconnection of the parallel earthing systems and they also save time because it is no longer necessary to search for the most suitable places to position the auxiliary stakes, a task which may take a long time on resistive soils.

### Measurement with earth clamp

The advantage of the earth clamp is that it is quick and easy to set up: simply clamp the cable connected to the earth in order to measure the earth value and the currents flowing in the earth.

An earth clamp comprises two windings: a "generator" winding and a "receiver" winding.

- The clamp's "generator" winding develops an AC voltage with a constant value  $E$  around the conductor clamped; a current  $I = E / R$  loop then flows through the resistive loop.
- The "receiver" winding measures this current.
- As  $E$  and  $I$  are now known, the loop resistance can be deduced from them.

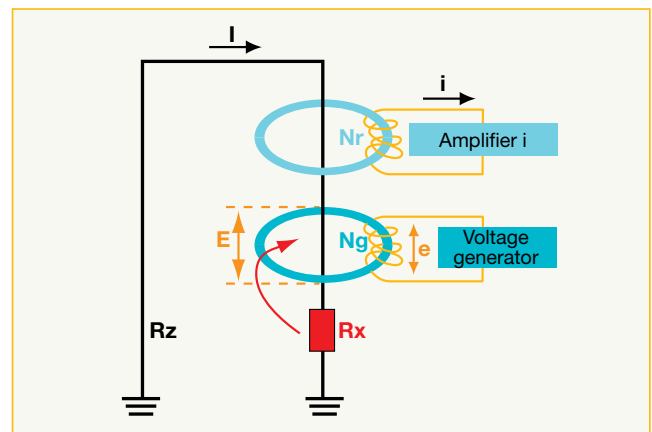



To correctly identify the measurement current and avoid disturbance currents, the earth clamp uses a specific measurement frequency.

For example, take the case of a parallel earth network in which we want to measure the earth resistance  $R_x$  in parallel with  $n$  earth electrodes.

This can be represented by the simplified diagram below:

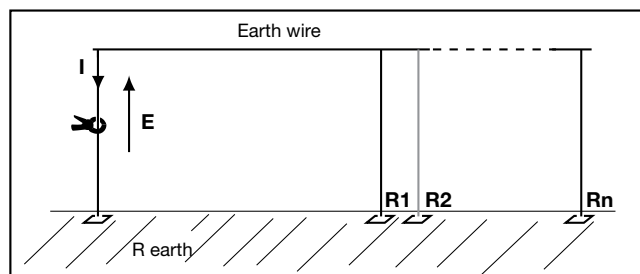

If the voltage  $E$  is applied to any point of the  $R_x$  earthing system, a current  $I$  flows in the loop in accordance with the following equation:

$$R_{\text{loop}} = E / I = R_x + R_{\text{earth}} + (R_1 // R_2 // R_3 \dots // R_n) + R_{\text{earth-wire}}$$

Where:

$R_x$  (value sought)

$R_{\text{earth}}$  (value usually very low, under 1  $\Omega$ )

$R_1 // R_2 \dots // R_n$  (negligible value: case of multiple earths in parallel)

$R_{\text{earth-wire}}$  (value usually very low, under 1  $\Omega$ )

As we know that "n" resistances in parallel are equivalent to a resistance  $R_{\text{aux}}$  whose value is negligible, by approximation:

$R_{\text{loop}}$  measured is equivalent to the earth resistance  $R_x$  to be measured.

### Earth loop measurement with 2 clamps

This method is based on the same principle as the earth clamp method.

It involves placing two clamps around the earth conductor tested and then connecting them to the tester. One clamp injects a known signal (32 V / 1367 Hz) while the other clamp measures the current flowing in the loop.

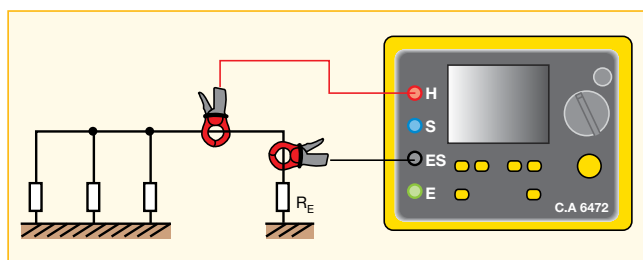

Instead of a single clamp containing the generator circuit and the receiver circuit, two clamps are used, with one serving as the generator and the other as the receiver. The advantage of having one clamp per function is that you can perform measurements on conductors where the earth clamp is not suitable, because of its clamping capacity or its thickness.

The C.A 6471 and C.A 6472 testers offer the 2-clamp function and can be used with C or MN clamps which cover a wide range of conductor cross-sections and applications.

**Caution: for earth loop measurements, there are several pitfalls to avoid and several points that need to be checked**

#### 1 - Number of earth electrodes in parallel

The approximation above shows that this method is only applicable if there is a low-impedance path parallel to the electrode tested. For this reason, it is advisable to assess the equivalent resistance of the  $n$  electrodes in parallel and check that its value is genuinely negligible upstream of  $R E$ .

*Example 1:*

There is a 20  $\Omega$  earth electrode in parallel with 100 other 20  $\Omega$  earth electrodes.

The resistance measured will be:

$$R_{\text{loop}} = 20 + 1 / 100 * (1/20) = 20 + 1/5 = 20.2 \Omega$$

The value obtained is very close to the actual value of  $R_1$ .

*Example 2:*

There is an earth electrode comprising only 2 parallel earths where  $R_1 = R_2 = 20 \Omega$

The resistance measured will be:

$$R_{\text{loop}} = R_1 + R_2 = 40 \Omega$$

The value measured is then very different from the actual value of  $R_1$ , which is 20  $\Omega$ . However, if the aim is not to measure the precise value of  $R_1$ , but to make sure it does not exceed a particular threshold, such as 100  $\Omega$  for example, this measurement method can also be used.

#### 2 - Identification of the circuit measured

To use the earth loop measurement method, it is important to find out the details of the electrical installation:

- if there is no low-impedance path parallel to the electrode tested, as in the case of a house with only one earth electrode, earth loop measurement is not possible because there is no path for the current to loop back.
- if the values measured are extremely low, you must check that the earth clamp has not been positioned on an equipotential bond. This measurement method can be used to test loop continuity, however

### 3 - Measurement frequency and impedance

It is important to note that, for the measurements described above, we refer to the "loop resistance". Seeing the measurement principle of the clamp and the general measurement signal (2403 Hz for the C.A 6410, C.A 6412 and C.A 6415, 1358 Hz for the C.A 6415R), it would be more appropriate to speak of "loop impedance" measurement. In fact, in practice, the serial reactive values in the loop (line inductance) can be considered negligible compared with the loop resistance, so the loop impedance  $Z$  is equivalent to the loop resistance value  $R$ .

On networks covering long distances such as railway lines, however, the inductive part may no longer be negligible. If so, the loop impedance measurement performed is a loop resistance measurement by excess.

To counteract this influence of the inductive part, the new Chauvin Arnoux earth testers allowing 2-clamp measurements (C.A 6471 & C.A 6472) have a measurement frequency of 128 Hz capable of limiting the influence of the inductive part of the line, while remaining as close as possible to the network frequency, and thus to the installation's normal operating conditions.

#### Coupling measurement

Coupling measurement is widely used by electricity suppliers to check the coupling between the medium and low-voltage networks.

It involves estimating the reciprocal influence of 2 earthing systems which are not normally linked physically.

Significant coupling between two earths may damage the equipment and threaten people's safety. When a fault current is drained by the chassis earth  $M$  of the medium-voltage (MV) network, it may cause a rise in the potential of the soil and therefore of the low-voltage (LV) network's neutral earth, endangering people's lives and risking damage to the equipment using the LV network.

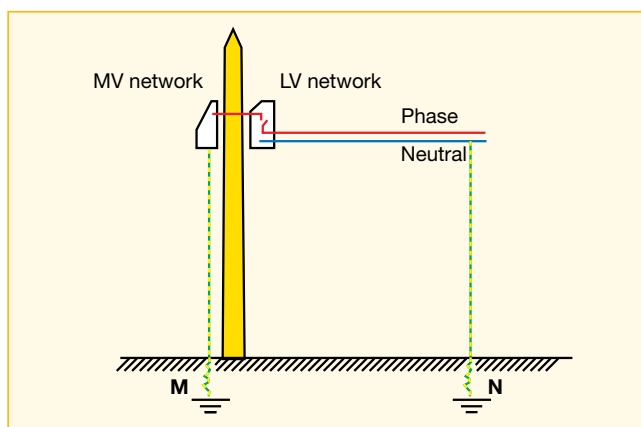

If lightning strikes the MV/LV transformer, the instantaneous rise in potential may amount to several kV.

The method to use is the "62 % method".

The auxiliary stakes H (return of current) and S (potential reference) must be positioned so that they ensure:

- sufficient decoupling from the earth electrode to be measured, as long as the distances indicated in the diagram below are respected.
- a valid earth potential reference.

Coupling can be measured as follows:

#### 1 Disconnect the neutral of the LV network (open A)\*

- Connect E and ES to N (LV neutral earth) with two 50 m cables
- Connect S to the 1st stake with a 50 m cable
- Connect H to the 2nd stake with a 100 m cable
- Place the measuring instrument between M and N at a point 20 m from their axis
- Measure the resistance of the neutral earth electrode:

$R_{\text{neutral}}$

\*Point A must be opened to measure the coupling of the 1st neutral earth electrode

#### 2 Repeat the procedure, but this time with E and ES connected to M (which is the chassis earth of the MV network)

(the LV neutral is still disconnected)

- Measure the resistance of the chassis earth electrode:  $R_{\text{chassis}}$

#### 3 Connect E and ES to M (MV chassis earth) using two 50 m cables

- Connect S and H to N (LV neutral earth) using two 50 m cables
- Measure  $R_{\text{chassis/neutral}}$

#### 4 Calculate the coupling:

$$R_{\text{coupling}} = [R_{\text{chassis}} + R_{\text{neutral}} - R_{\text{chassis/neutral}}] / 2$$

#### 5 Calculate the coupling coefficient:

$$k = R_{\text{coupling}} / R_{\text{chassis}}$$

In France, this coefficient must be  $< 0.15$  (EDF directive)  
Important: do not forget to reconnect A

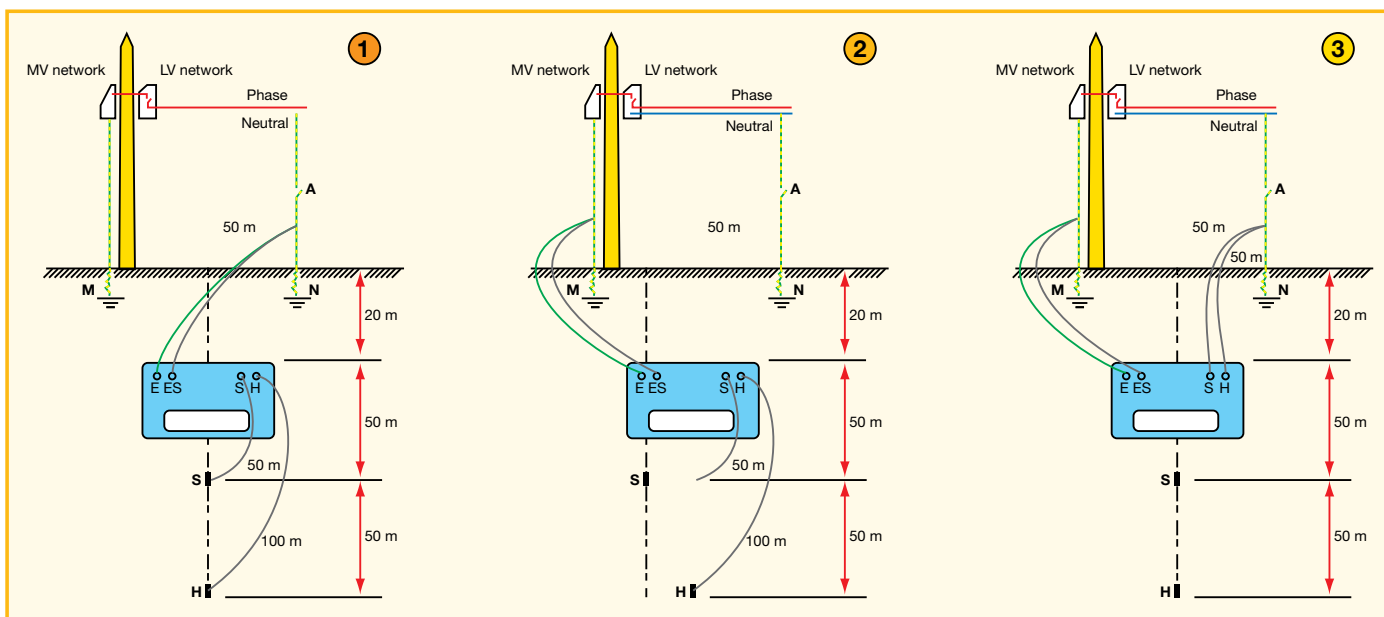

### Earth resistance measurement at high frequencies

All the earth resistance measurements described so far are carried out at low frequency, which means a frequency close to the network frequency, so that the measurement conditions are as close to the real conditions as possible. In addition, an earth-electrode resistance measurement is in principle independent of the frequency because the earth electrode is normally purely resistive.

However, complex earth networks with several earths in parallel may also be significantly inductive due to the cables linking the different earths. In addition, on some older installations, although you may think you have isolated the earth by opening the earth bar, it may in fact have hidden connections to other earths. Even though the inductive value of these earths is low at low frequencies, it may become very high at high frequencies (due to lightning, for example). As a result, even if the earthing system is effective at low frequencies because of the low resistance, the impedance value at high frequency may not allow fault currents to drain away properly. Lightning may therefore follow an unexpected path rather than draining via the earth.

Earth resistance measurement combined with frequency analysis can therefore be used to check the behaviour of the earthing system in the event of lightning.

### Earth resistance measurement on pylons linked by an overhead earth cable

High-voltage lines are usually equipped with a protective overhead earth cable for draining lightning currents to earth via the pylons.

Because all the pylons are linked to one another by this conductor, all the pylons' earth resistances are in parallel, leading to a situation involving networks of multiple earths in parallel, as described above.

If you use traditional methods, you can only measure the overall earth of the high-voltage line, i.e. all the earths in parallel. As there are a large number of pylons, this overall measured value may be very low even though the earth value of one of the pylons is too high. This means it is impossible to measure the resistance of a pylon with traditional methods, unless you isolate the earth to be measured by disconnecting the overhead earth cable, which is a difficult and dangerous job.

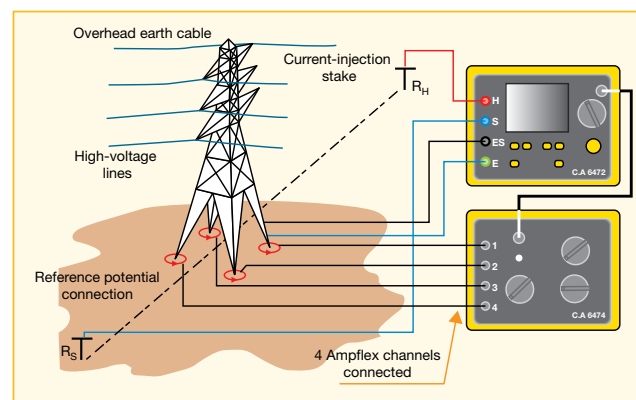

### Measurement principle

When the C.A 6472 is hooked up to a C.A 6474 vectorial processing unit, it can be used to measure a pylon's earth resistance with a selective measurement method, even if the pylon is part of a parallel earth network. This method involving the C.A 6472 and C.A 6474 combines two measurement principles:

**1. Use of 4 flexible current sensors (AmpFLEX™)** placed around the pylon footings to measure the precise current flowing in the pylon's earth. This selective measurement is based on the same principle as selective measurement with a current clamp, except an AmpFLEX™ sensor is used instead of the clamp.

## 2. High-frequency measurement up to 5 kHz, providing:

- an equivalent  $Z$  value (see diagram) which is much higher than the earth resistance to be measured. As a result, the current drained to the other pylons by the overhead earth cable becomes negligible and the value of the current flowing via the earth increases. This significantly improves the accuracy of the measurements.
- the possibility of frequency scanning from 41 Hz to 5 kHz to study the behaviour of the earthing system according to the frequency and to forecast its behaviour in the event of lightning.

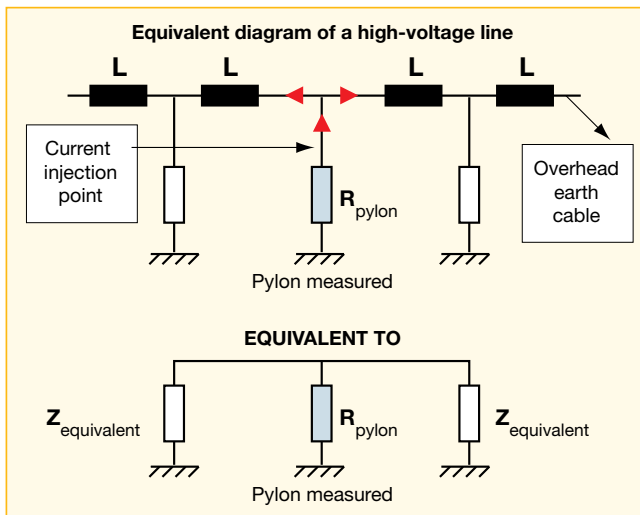

## Measurement methods

The C.A 6474 can be used for pylon earth resistance measurements with 2 methods:

- 1. The active method** with injection of a measurement current by the C.A 6472 (like traditional 3-pole or 4-pole measurements).
- 2. The passive method** using the residual currents flowing in the high-voltage line. This passive method is useful for checking the consistency of the measurements obtained with the active method. It also guarantees measurement results whatever the conditions, as highly-resistive terrain may prevent a sufficient measurement current from flowing, making it impossible to use the active method.

## Other measurements

When coupled with the C.A 6474, the C.A 6472 is a genuine diagnostic tool for high-voltage lines. In addition to precise, selective measurement of pylon impedance, it can also be used for:

- **measurement of the overall line impedance according to the frequency** so that you can forecast the line's behaviour if there is a fault. In the event of lightning, the line impedance must be low enough to allow the fault currents to flow via the overhead earth cable and then to drain to earth via the pylons.

- **assessment of the quality of the overhead earth cable connection:** as fault currents are drained by the overhead earth cable and then by the pylons, there must be a good-quality connection between the two. By measuring the current drained by the top of the pylon, the contact resistance between the overhead earth cable and the pylon can be measured to detect whether the connection is satisfactory.
- **measurement of the earth resistance on each footing of the pylon:** this can be used to test the quality of the connection to the earthing system on one or more pylon footings.

## Parameters that influence earth resistance measurements

There are two main parameters that influence earth resistance measurements:

- the resistance of the auxiliary stakes H and S,
- disturbance voltages.

## Resistance of the auxiliary stakes H and S

If the resistance of the auxiliary stakes H and S is high because the ground is particularly resistive (in rocky terrain, for example), it affects the accuracy of the measurements: the measurement current becomes extremely weak and may no longer be sufficient to measure the earth.

Chauvin Arnoux's C.A 647x range of earth testers can be used to measure the resistance of the auxiliary stakes and thus detect when their resistance is too high. This helps to save time because the stake at fault is identified immediately so it is no longer necessary to go to and fro between the different stakes.

This problem of excessive stake resistance can be solved by adding stakes in parallel, by inserting the stakes deeper in the ground and/or by moistening the soil.

In addition, not all earth testers accept the same maximum value for auxiliary stake resistances and this is one of the differences between a basic earth tester and an expert model.

## Disturbance voltages on the installation tested

Earth resistance measurements may be affected by the presence of disturbance voltages. This is why you must use an earth ohmmeter, an instrument specially designed to be immune to disturbance currents, for your earth resistance measurements.

Sometimes however, the 128 Hz frequency generally used and the level of the disturbance voltages no longer allow the measurement to be performed. If these voltages can be detected and measured, you can assess their influence on the measurement and thus understand the problem when measurement is impossible. Some testers include a flashing symbol to warn users when there are significant disturbance voltages, as well as a system that automatically chooses the test frequency with the lowest noise.

In this way, the functions for measuring the resistance of the auxiliary stakes and the disturbance voltages improve measurement interpretation and save time in the field, helping you to understand and solve any malfunctions. Indeed, if the value measured is significantly higher than the expected value, it may mean either that the earth is genuinely defective or that external parameters have caused a measurement error. This is why it is important to choose an earth tester suitable for the expected measurement conditions:

- presence or absence of high disturbance voltages
- high soil resistivity

### Specific precautions for earth resistance measurements

1. To avoid the influence zones, you are advised to choose the largest possible distances between the H and S stakes and the earth to be tested E.
2. To avoid electromagnetic interference, it is recommended to unroll the whole length of the cable from the winder and to place the cables on the ground without loops, as far as possible from one another, and to avoid setting them up too close to or parallel to metal conductors (cables, rails, fences, etc.).
3. To maintain acceptable measurement accuracy, it is advisable to ensure low auxiliary stake resistances, if necessary by planting the stakes deeper in the ground and/or by moistening the soil.
4. To check that the measurement is valid, you are advised to carry out another measurement after moving the 0 V reference stake S.

## Overview of the different earth resistance measurement methods

	Rural building with possibility of planting stakes	Urban building without possibility of planting stakes
<b>Single earth electrode</b>		
3-pole "62 %" method	■	
Triangle method (2 stakes)	■	
4-pole method	■	
Variant 62 % method (1 stake)		■ TT systems only
Phase-PE loop measurement	■	
<b>Multiple earths in parallel</b>		
Selective 4-pole method	■	
Earth clamp	■	■
2-clamp earth loop measurement	■	■

### Note:

In cases involving a network of multiple earths in parallel, the traditional methods applied to single earth electrodes may be used:

1. if you only require the overall earth value.
2. if the earth electrode measured can be disconnected from the earth network.

## Frequently-asked questions

### Can water or gas pipes be used as earth electrodes?

It is strictly forbidden to use underground metal pipes as earth electrodes.

Similarly, it is prohibited to use metal water risers as the main protective conductor (earth riser) because the electrical continuity of these pipes is not always guaranteed (for example in the event of work on the installation).

### I am in a house and have performed phase-earth loop measurement and 3-pole measurement using stakes. The value measured with the 3-pole method is much higher.

#### How come the 2 methods don't give the same result?

As seen on page 7, the earthing system may comprise not only the earth electrode but also de facto earth electrodes such as the metal pipes of the water or gas distribution networks.

For this reason, a 3-pole earth resistance measurement with the bar opened can be used to measure the real resistance of the earth electrode, whereas a loop measurement will also include earthing via de facto earth electrodes.

### I measured the earth a few months ago but the result of a measurement now is not the same.

#### How is this possible?

As explained on page 3, the earth resistance value is influenced by the temperature and humidity.

So it is quite normal to find significant differences between measurements carried out in different weather conditions.

# DataView®

(for the C.A 6470N/C.A 6471 /C.A 6472 + C.A 6474)

**The essential tool for real-time display of the data, retrieval of the recorded data and creation of standard or customized measurement reports.**  
**Also configures and remotely activates measurements.**

(DataView® software is available in 5 languages: French, English, German, Spanish and Italian)

- Configuration of the measurement parameters for all the functions
- Remote activation of the tests with a single click
- Retrieval of the data recorded in the instruments
- Possibility of adding user comments directly to the measurement report
- Possibility of creating customized report models
- Display of the result curves: impedance measurement as a function of frequency, display of theoretical step voltage as a function of distance, etc.
- Printing of standard or customized measurement reports

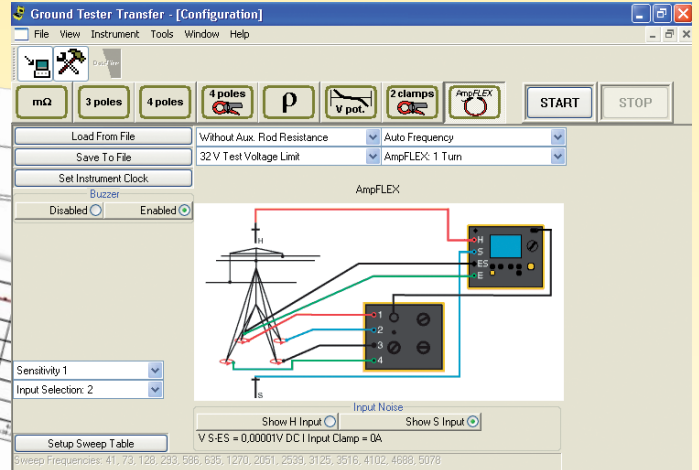
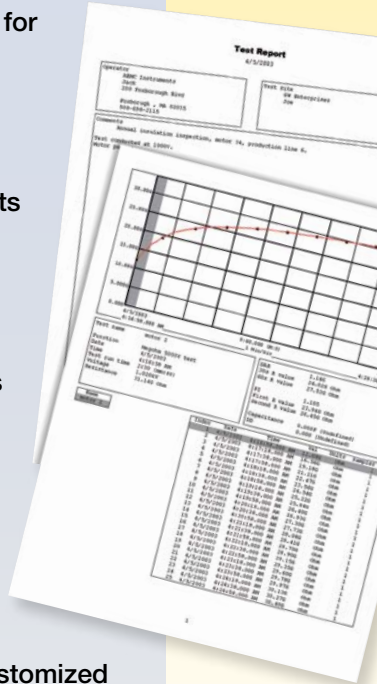

Parameter settings for the measurement method selected and graphic display of the measurement set-up.

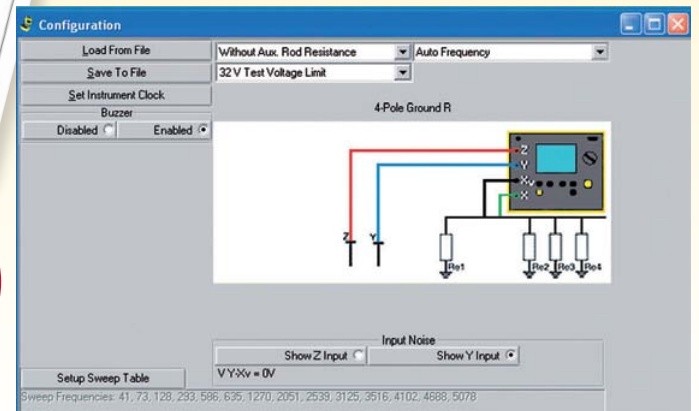

Parameter settings for the measurement method selected and graphic display of the measurement set-up.

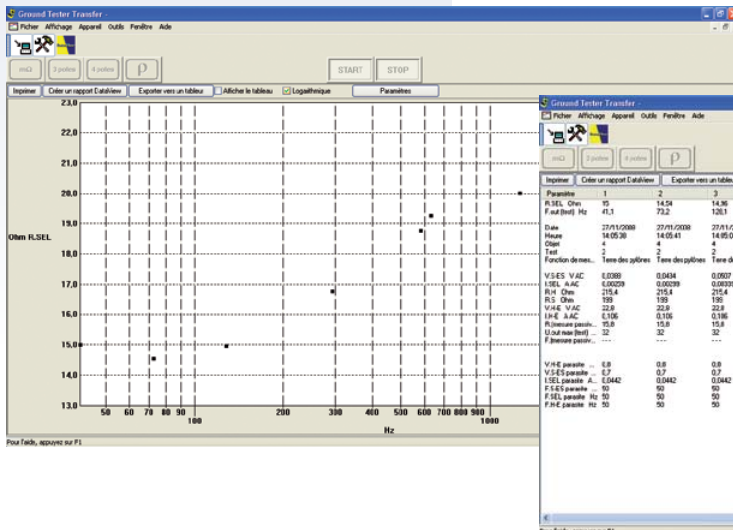

The screenshot shows the 'Configuration' window. It has a menu bar (Fichier, Affichage, Appareil, Outils, Fenêtre, Aide) and a toolbar with buttons for 'mΩ', '3 poles', '4 poles', 'P', 'V pot.', '2 clamps', and 'AMPFLEX'. Below the toolbar are buttons for 'START' and 'STOP'. A wiring diagram shows a ground tester connected to a 4-Pole Ground R. Below the diagram are 'Show Z Input' and 'Show Y Input' buttons, and a 'Setup Sweep Table' button. The status bar shows 'Sweep Frequencies: 41, 73, 128, 233, 566, 635, 1270, 2051, 2539, 3125, 3516, 4102, 4688, 5078'.

Activation of the test and results in graphic or numeric form.



	C-A 6421	C-A 6423	C-A 6460	C-A 6462	C-A 6470N TERCA 3	C-A 6471	C-A 6472	C-A 6410	C-A 6412	C-A 6415
<b>Earth resistance</b>										
3-pole method	●	●	●	●	●	●	●			
4-pole method			●	●	●	●	●			
Automatic coupling					●	●	●			
<b>Selective earth resistance measurement</b>										
4-pole + clamp method						●	●			
2-clamp method						●	●			
Earth clamp								●	●	●
<b>Pylon earth</b>										
with C.A 6474							●			
<b>Soil resistivity</b>										
Manual			●	●						
Automatic					●	●	●			
<b>Potential measurement</b>										
							●			
<b>Continuity</b>										
					●	●	●			
<b>Measurement frequency</b>										
Single frequency: 128 Hz	●	●	●	●						
Single frequency: 2,403 Hz								●	●	●
41 to 512 Hz					●	●				
41 to 5,078 Hz							●			
<b>Rs, Rh measurements &amp; displays (auxiliary state resistances)</b>										
					●	●	●			
<b>U disturbance measurement &amp; display (noise on earth)</b>										
					●	●	●			
<b>Display</b>										
Analogue	●									
LCD		●	●	●				●	●	●
Triple-display LCD					●	●	●			
<b>Power supply</b>										
Batteries	●	●	●					●	●	●
Rechargeable batteries				●	●	●	●			
Page no	16	16	18	18	20	22	24	30	30	30

## 3-pole earth resistance testers

### C.A 6421 & C.A 6423

The standalone, leakproof C.A 6421 and C.A 6423 earth testers are very easy-to-operate, lightweight instruments designed for use in the field or in difficult conditions. They provide quick, accurate earth resistance measurements in comfortable, safe conditions with the traditional 3-pole stake-based method. After setting up and connecting the stakes, simply press a button to read the resistance measurement while monitoring the reliability by means of LEDs.

#### Ergonomics

- Leakproof site case for use in the field
- Easy-to-read analogue or digital display
- Simple to operate
- Instant connection thanks to colour-coding of the terminals and leads

#### Measurements

- Resistance measurement by 2 or 3-pole method
- Designed to reject high levels of noise and interference
- Direct reading of the result between 0.5  $\Omega$  and 2,000  $\Omega$  (1000  $\Omega$  on the C.A 6421)
- Auto-ranging (for the C.A 6423)
- Measurement fault or disturbance indicator LEDs

#### Power supply

- Battery-powered
- Battery life equivalent to 1,800 measurements each lasting 15 seconds



C.A 6421



C.A 6423



	C.A 6421	C.A 6423
<b>Specifications</b>		
Measurement	Earth resistance	Earth resistance
Type	2P & 3P	2P & 3P
Resistivity	No	No
Measurement range	0.5 Ω to 1,000 Ω	0.01 Ω to 2,000 Ω (3 automatic calibres)
Resolution	-	10 mΩ / 100 mΩ / 1 Ω (depending on calibre)
Accuracy	± (5 % + 0.1 % at full scale)	± (2 % + 1 count)
No-load voltage	≤ 24 V	≤ 48 V
Frequency	128 Hz	128 Hz
Alarms	3 fault-indicator LEDs to validate the measurement	3 fault-indicator LEDs to validate the measurement
<b>Other features</b>		
Power supply	8 x 1.5 V batteries	8 x 1.5 V batteries
Display	Analogue	2,000-count digital LCD screen
Electrical safety	IEC 61010 & IEC 61557	IEC 61010 & IEC 61557
Dimensions	238 x 136 x 150 mm	238 x 136 x 150 mm
Weight	1.3 kg	1.3 kg

## References to order

> **C.A 6421** ..... **P01123011**  
Delivered with 1 carrying strap, 8 x LR6 1.5 V batteries, 1 operating manual in 5 languages

> **C.A 6423** ..... **P01127013**  
Delivered with 1 carrying strap, 8 x LR6 1.5 V batteries, 1 operating manual in 5 languages

## Accessories / Spares

Carrying strap..... P01298005  
0.1 A - 250 V HRC fuses (set of 10)..... P01297012  
1.5 V ALK LR6 battery ..... P01296033  
1.5 V ALK LR6 batteries (x 12) ..... P01296033A  
1.5 V ALK LR6 batteries (x 24) ..... P01296033B

See page 28 for the earth and/or resistivity kits

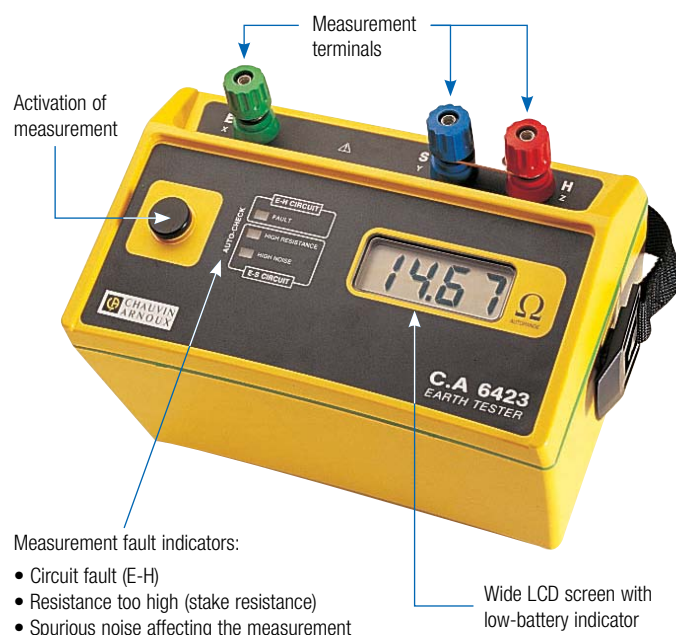

## 3 and 4 pole earth resistance and soil resistivity testers

### C.A 6460 & C.A 6462

A genuine 3-in-1 tester delivered in a rugged, leakproof case, the C.A 6462 is specially designed for use in the field. Particularly simple to use wherever you need to set up an earth electrode or test an existing earth connection, this tester helps you to quickly make a precise, reliable diagnosis while maintaining user comfort and safety.

#### Ergonomics

- Rugged, leakproof site case for use in the field
- Large 2,000-count backlit LCD screen for easy reading
- Digital display of the values measured and the units
- Simple to operate
- Instant connection thanks to colour-coding of the terminals and leads

#### Measurements

- Earth resistance measurement with the 3 or 4-pole method and soil resistivity measurement
- Designed to reject high levels of noise and interference
- Auto-ranging
- 3 warning LEDs: high noise level, high auxiliary stake resistance, connection fault

#### Power supply

- Battery-powered (C.A 6460) or rechargeable battery (C.A 6462)



C.A 6460



C.A 6462

	C.A 6460	C.A 6462
<b>Specifications</b>		
<b>Measurements</b>	Earth resistance / Soil resistivity / Coupling	Earth resistance / Soil resistivity / Coupling
<b>Type</b>	3-pole & 4-pole	3-pole & 4-pole
<b>Measurement range</b>	0.01 $\Omega$ to 2,000 $\Omega$ (3 automatic ranges)	0.01 $\Omega$ to 2,000 $\Omega$ (3 automatic ranges)
<b>Resolution</b>	10 m $\Omega$ / 100 m $\Omega$ / 1 $\Omega$ (depending on range)	10 m $\Omega$ / 100 m $\Omega$ / 1 $\Omega$ (depending on range)
<b>Accuracy</b>	$\pm$ (2 % + 1 count)	$\pm$ (2 % + 1 count)
<b>No-load voltage</b>	$\leq$ 24 V	$\leq$ 48 V
<b>Frequency</b>	128 Hz	128 Hz
<b>Warnings</b>	3 fault-indication LEDs to validate the measurement	3 fault-indication LEDs to validate the measurement
<b>Other features</b>		
<b>Power supply</b>	8 x 1.5 V batteries	Rechargeable NiMH battery
<b>Display</b>	2,000-count digital LCD	2,000-count digital LCD
<b>Electrical safety</b>	IEC 61010 & IEC 61557	IEC 61010 & IEC 61557
<b>Dimensions</b>	270 x 250 x 110 mm	270 x 250 x 110 mm
<b>Weight</b>	2.8 kg	3.3 kg

## References to order

- > **C.A 6460** ..... **P01126501**  
Delivered with 8 x 1.5 V LR6 batteries and 1 operating manual in 5 languages
- > **C.A 6462** ..... **P01126502**  
Delivered with 1 mains lead for recharging and 1 operating manual in 5 languages

## Accessories / Spares

- 0.1 A - 250 V HRC fuses (set of 10) ..... P01297012
- Battery pack ..... P01296021
- 1.5 V ALK LR6 battery ..... P01296033
- 1.5 V ALK LR6 batteries (x 12) ..... P01296033A
- 1.5 V ALK LR6 batteries (x 24) ..... P01296033B

See page 28 for the earth and/or resistivity kits



## 3 and 4 pole earth resistance and soil resistivity tester

### C.A 6470N TERCA 3

*This earth resistance and soil resistivity tester is part of Chauvin Arnoux's comprehensive range of multi-function testers. An expert instrument which is nevertheless simple to operate, delivered in a rugged, leakproof site case for use in the field, its ergonomics are functional: large backlit screen, automatic identification of connections by means of colour coding, switch for direct access to the measurements – all helping to ensure total user safety.*

#### Ergonomics

- Leakproof site case for use in the field
- Large backlit LCD screen and particularly legible multi-display
- Simple to operate
- Automatic detection of connection errors
- Instant connection thanks to colour-coding of the terminals and leads
- Improved safety with display of connections on the screen
- USB communication interface
- Compatible with the DataView® software



C.A 6470N TERCA 3

#### Measurements

- Earth resistance measurement with the 3 or 4-pole method
- Soil resistivity: automatic calculation (Wenner and Schlumberger methods)
- Coupling measurement
- 200 mA continuity / bound resistance test (2 and 4 wire)
- Measurement test frequency: 41 to 512 Hz
- Measurement of auxiliary stake resistance
- High rejection of disturbance voltages up to 60 V peak
- Data storage for retrieval and reporting

#### Power supply

- Powered by rechargeable batteries
- Adapters for battery charging on 12 V vehicle cigarette lighter or mains supply



**DataView®**



## C.A 6470N Terca 3

Specifications		
<i>Earth resistance 3-pole method</i>	Range	0.01 $\Omega$ to 99.99 k $\Omega$
	Resolution	0.01 $\Omega$ to 100 $\Omega$
	Test voltage	16 V or 32 V, selectable
	Measurement frequency	40 Hz to 512 Hz automatic or manual
	Test current	Up to 250 mA
	Accuracy	$\pm 2$ % of value $\pm 1$ count
<i>Earth resistance 4-pole method</i>	Range	0.001 $\Omega$ to 99.99 k $\Omega$
	Resolution	0.001 $\Omega$ to 100 $\Omega$
	Test voltage	16 V or 32 V
	Measurement frequency	40 Hz to 512 Hz automatic or manual
	Test current	Up to 250 mA
	Accuracy	$\pm 2$ % R $\pm 1$ count
<i>Earth resistance Soil resistivity measurement 4-pole method</i>	Measurement method	Wenner or Schlumberger method with automatic calculation of results and display in $\Omega$ -metres or $\Omega$ -feet
	Range (automatic selection)	0.01 $\Omega$ to 99.99 k $\Omega$
	Resolution	0.01 $\Omega$ to 100 $\Omega$
	Test voltage	16 or 32 V, selectable
<i>External voltage measurement</i>	Range (automatic selection)	0.1 to 65.0 VAC/DC – DC to 450 kHz
	Accuracy	$\pm 2$ % R + 2 counts
<i>Resistance measurement/ continuity and bounding</i>	Type of measurement	2 wire or 4 wire, selectable
	Range (automatic selection)	2 wire: 0.01 $\Omega$ to 99.9 k $\Omega$ – 4 wire: 0.001 $\Omega$ to 99.99 k $\Omega$
	Accuracy	$\pm 2$ % R + 2 counts
	Test voltage	16 VDC (polarity +, - or auto)
	Test current	> 200 mA max. for R < 20 $\Omega$
<i>Data Storage</i>	Memory capacity	512 test results
	Communication	Optically-isolated USB
Other features		
Power supply	Rechargeable battery	
Battery-charger power supply	External power supply with 18 Vdc / 1.9 A output or 12 Vdc vehicle power supply	
Electrical safety	50 V CAT IV	
Dimensions / Weight	272 x 250 x 128 mm / 3 kg	

### Reference to order

> **C.A 6470N Terca 3** ..... **P01126506**  
 Delivered with 1 mains adapter + 2-pole mains cable for recharging the battery from the mains, data export software + 1 optical/USB communication cable, 5 operating manuals (one per language) on CD-ROM, 5 simplified operating manuals, each in a different language, 5 identification labels, each in a different language.



### Accessories / Spares

DataView® report generation software .....	P01102095
Adapter for recharging on vehicle cigarette lighter .....	P01102036
Optical/RS communication cable .....	P01295252
GB mains power cable .....	P01295253
Set of 10 fuses –	
F 0.63 A - 250 V - 5 x 20 mm - 1.5 kA .....	AT0094
Adapter for charging battery from the mains .....	P01102035
Battery pack .....	P01296021
Optical/USB communication cable .....	HX0056-Z

See page 28 for the earth and/or resistivity kits

## Expert earth resistance and soil resistivity tester

### C.A 6471

*This earth resistance and soil resistivity tester, which is part of Chauvin Arnoux's comprehensive range of multi-function testers, is a 5-in-1 tool: earth, selective earth, resistivity, coupling and continuity in an expert on-site instrument delivered in a rugged, leakproof site case. It is simple to use, with functional ergonomics: large backlit screen, automatic identification of connections by colour coding, switch for direct access to the measurements, etc., ensuring total user safety and reliable measurements even in highly resistive soils.*



C.A 6471

### Ergonomics

- Leakproof site case for use in the field
- Large backlit LCD screen and particularly legible multi-display (3 lines)
- Simple to operate
- Automatic recognition of connections
- Instant connection thanks to colour-coding of the terminals and leads
- Improved safety with display of connections on the screen
- USB communication interface
- Compatible with the DataView® software

### Measurements

- Earth resistance measurement with the 3 or 4-pole method
- Selective earth resistance measurement (4-pole method with clamp, loop measurement with 2 clamps)
- Soil resistivity: automatic calculation (Wenner and Schlumberger methods)
- Coupling measurement
- 200 mA continuity / bound resistance test (2 or 4 wire)
- Measurement frequency: 41 to 512 Hz (stake earth) and 128 Hz to 1758 Hz (selective measurement with clamps)
- Measurement of auxiliary stake resistance
- High rejection of disturbance voltages up to 60 V
- Data storage for retrieval and reporting

### Power supply

- Powered by rechargeable batteries
- Adapters for battery charging on 12 V vehicle cigarette lighter or mains supply



**DataView®**



## C.A 6471

Specifications		
<i>Earth resistance Measurement with 2 clamps</i>	Range	0.01 Ω to 500 Ω
	Resolution	0.01 Ω to 1 Ω
	Measurement frequency	Auto: 1367 Hz ; Manual: 128 Hz - 1367 Hz - 1611 Hz - 1758 Hz
<i>Earth resistance 3-pole method</i>	Range	0.01 Ω to 99.99 kΩ
	Resolution	0.01 Ω to 100 Ω
	Test voltage	16 V or 32 Vrms rated voltage, selectable by user
	Measurement frequency	41 Hz to 512 Hz, automatic or manual
	Test current	Up to 250 mA
	Accuracy	±2 % L + 1 count to 128 Hz
<i>Earth resistance 4P measurements / 4P + measurements with clamps</i>	Range	0.001 Ω to 99.99 kΩ
	Resolution	0.001 Ω to 100 Ω
	Test voltage	16 V or 32 V selectable
	Measurement frequency	41 Hz to 512 Hz automatic or manual
	Test current	Up to 250 mA
	Accuracy	±2 % of value ±1 count
<i>Soil resistivity measurement</i>	Measurement method	Wenner or Schlumberger method with automatic calculation of results and display in Ω-metres or Ω-feet
	Range (automatic selection)	0.01 Ω to 99.99 kΩ ; P max. 999 kΩm
	Resolution	0.01 Ω to 100 Ω
	Test voltage	16 V or 32 V, selectable
	Measurement frequency	41 Hz to 512 Hz selectable
<i>External voltage measurement</i>	Range (automatic selection)	0.1 to 65.0 VAC/DC – DC to 450 kHz
	Accuracy	±2 % R + 1 count
<i>Resistance measurement/ continuity and bounding</i>	Type of measurement	2 wire or 4 wire method, selectable by user
	Range (automatic selection)	2 wire: 0.01 Ω to 99.9 kΩ – 4 wire: 0.001 Ω to 99.99 kΩ
	Accuracy	±2 % R + 2 counts
	Test voltage	16 VDC (polarity +, - or auto)
	Test current	> 200 mA max. for R < 20 Ω
<i>Data storage</i>	Storage capacity	512 test results
	Communication	Optically-isolated USB
<b>Other features</b>		
Power supply	Rechargeable battery	
Battery-charger power supply	External power supply with 18 VDC / 1.9 A output or 12 VDC vehicle power supply	
Electrical safety	50 V CAT IV	
Dimensions / Weight	272 x 250 x 128 mm / 3 kg	

## Reference to order

> **C.A 6471** ..... **P01126505**  
 Delivered with 1 mains adapter + 2-pole mains power lead for recharging the battery, data export software + optical/USB communication lead, 2 x C182 clamps with 2 safety leads, 5 operating manuals (1 per language) on CD-ROM, 5 simplified operating manuals each in a different language, 8 specifications labels each in a different language, 1 carrying bag.



## Accessories / Spares

DataView® report printing software.....	P01102095
Adapter for battery charging on vehicle cigarette-lighter .....	P01102036
Optical / RS communication cable .....	P01295252
GB mains power cable .....	P01295253
Set of 10 fuses F 0,63 A - 250 V - 5 x 20 mm - 1.5 kA ....	AT0094
Adapter for battery charging on mains .....	P01102035
Battery pack .....	P01296021
Optical/USB communication cable .....	HX0056-Z
MN62 clamp (Ø. 20 mm) (with 2 m cable for ES terminal connection) .....	P01120452
C182 clamp (Ø 20 mm) (with 2 m cable for ES terminal connection) .....	P01120333

See page 28 for the earth and/or resistivity kits

## Expert earth resistance and soil resistivity tester

### C.A 6472

The C.A 6472 earth resistance and soil resistivity tester is a versatile instrument capable of carrying out a quick but thorough survey of all the earthing configurations by combining all the earth resistance measurement functions in a single tool. Maintaining the same simple ergonomics as its predecessors, it is delivered in a rugged, leakproof site case. In addition, when coupled with the C.A 6474, it can be used to measure pylon earth resistances, making it an essential tool for diagnostics and maintenance of earthing systems on all types of pylons.

### Ergonomics

- Leakproof site case for use in the field
- Large backlit LCD screen and particularly legible multi-display
- Simple to operate
- Automatic recognition of connections
- Instant connection thanks to colour-coding of the terminals and leads
- Improved safety with display of connections on the screen
- USB communication interface
- Compatible with the DataView® software



C.A 6472



**DataView®**

### Measurements

- Earth resistance measurement by 3 or 4-pole method
- Soil resistivity: automatic calculation (Wenner and Schlumberger methods)
- Selective earth resistance measurement (4-pole measurement with clamp, loop measurement with 2 clamps)
- Measurement of ground potential according to the distance
- Pylon earth resistance measurement (when used with C.A 6474)
- Coupling measurement
- 200 mA continuity
- Measurement frequency range from 41 to 5,078 Hz (automatic for the most appropriate measurement frequency, as well as manual or sweep modes)
- Measurement of auxiliary stake resistance
- High rejection of disturbance voltages up to 60 V peak
- Data storage



### Power supply

- Powered by rechargeable batteries
- Adapters for battery charging on vehicle cigarette lighter or mains supply



## C.A 6472

Specifications		
<i>Earth resistance Measurements with 2 clamps</i>	Range	0.01 $\Omega$ to 500 $\Omega$
	Resolution	0.01 $\Omega$ to 1 $\Omega$
	Measurement frequency	Auto: 1,367 Hz ; Manual: 128 Hz - 1,367 Hz - 1,611 Hz - 1,758 Hz
<i>Earth resistance 3-pole measurements</i>	Range (automatic selection)	0.01 $\Omega$ to 99.99 k $\Omega$
	Resolution	0.01 $\Omega$ to 100 $\Omega$
	Test voltage	16 V or 32 Vrms rated voltage, selectable by user
	Measurement frequency	41 Hz to 5078 Hz automatic or manual
	Test current	Up to 250 mA
	Accuracy	$\pm 2\%$ R + 1 count at 128 Hz
<i>Earth resistance 4P measurements/ 4P measurements with clamps</i>	Range	0.001 $\Omega$ to 99.99 k $\Omega$
	Resolution	0.001 $\Omega$ to 100 $\Omega$
	Test voltage	16 V or 32 V selectable
	Measurement frequency	De 40 Hz to 512 Hz automatic or manual
	Test current	Up to 250 mA
	Accuracy	$\pm 2\%$ R $\pm 1$ count
<i>Soil resistivity measurement – 4-pole method</i>	Measurement method	Wenner or Schlumberger method with automatic calculation of results and display in $\Omega$ -metres or $\Omega$ -feet
	Range (automatic selection)	0.01 $\Omega$ to 99.99 k $\Omega$ ; P max. 999 k $\Omega$ m
	Resolution	0.01 $\Omega$ to 100 $\Omega$
	Test voltage	16 or 32 V, selectable
	Measurement frequency	41 to 512 Hz, selectable
<i>External voltage measurement</i>	Range (automatic selection)	0.1 to 65.0 VAC/DC – DC to 450 kHz
	Accuracy	$\pm 2\%$ R + 1 count
<i>Resistance measurement/ continuity and bounding</i>	Type of measurement	2 wire and 4 wire method, selectable by user
	Range (automatic selection)	2 wire: 0.01 $\Omega$ to 99.9 k $\Omega$ – 4 wire: 0.001 $\Omega$ to 99.99 k $\Omega$
	Accuracy	$\pm 2\%$ R + 2 counts
	Test voltage	16 VDC (polarity +, - or auto)
	Test current	> 200 mA for R < 20 $\Omega$
<i>Data storage</i>	Storage capacity	512 test results
	Communication	Optically-isolated USB
<b>Other features</b>		
Power supply	Rechargeable battery	
Battery-charger power supply	External power supply with 18 VDC / 1.9 A output or 12 VDC vehicle power supply	
Electrical safety	50 V CAT IV	
Dimensions / Weight	272 x 250 x 128 mm / 3.2 kg	

## Reference to order

> **C.A 6472** ..... **P01126504**  
 delivered with 1 mains adapter + 2-pole mains power lead for recharging the battery, data export software + optical/USB communication lead, 2 x C182 clamps with 2 safety leads, 5 operating manuals (1 per language) on CD-ROM, 5 simplified operating manuals each in a different language, 8 specifications labels each in a different language, 1 carrying bag



## Accessories / Spares

DataView® report printing software..... P01102095  
 Adapter for battery charging on vehicle cigarette-lighter ..... P01102036  
 Optical / RS communication cable ..... P01295252  
 GB mains power cable ..... P01295253  
 Set of 10 fuses F 0,63 A - 250 V - 5 x 20 mm - 1.5 kA .... AT0094  
 Adapter for battery charging on mains ..... P01102035  
 Battery pack ..... P01296021  
 Optical/USB communication cable ..... HX0056-Z  
 MN62 clamp (Ø. 20 mm)  
 (with 2 m cable for ES terminal connection) ..... P01120452  
 C182 clamp (Ø 20 mm)  
 (with 2 m cable for ES terminal connection) ..... P01120333

See page 28 for the earth and/or resistivity kits

## Pylon earth resistance measurement

### C.A 6474

*"When it is hooked up to the C.A 6472 expert earth resistance and soil resistivity tester, the C.A 6474 provides a unique solution for measuring pylon earth networks. By means of specific selective earth resistance measurements, it is possible to determine the various resistance values for a particular pylon without disconnecting the overhead earth wire of the pylon network, which is a dangerous and time-consuming task. In addition, by using AmpFLEX™ flexible sensors, you can measure the earth whatever the pylon's geometric configuration."*



C.A 6474

### Ergonomics

- Leakproof site case for use in the field
- Use of flexible current sensors for easy clamping around pylon footings
- Equipment adaptable to all types of pylon configurations (1, 2, 3 or 4 legs)
- Compatible with the DataView® software

### Measurements

- Pylon earth resistance measurements: selective measurement for determining the pylon's earth resistance without disconnection from the network. Measurements can be carried out at up to 5 kHz in automatic, fixed-frequency or sweep mode
- Measurement of the pylon's overall earth resistance
- Measurement of the earth resistance of each pylon footing
- Measurement of the overall line impedance
- Measurement of the overhead earth-wire (counterpoise, guard line) resistance without disconnection

### Power supply

- Powered by the C.A 6472



**DataView®**



C.A 6474	
<b>Specifications</b>	
Type of measurement	Overall pylon earth resistance Earth resistance of each pylon footing Overall line impedance Quality of overhead earth wire connection. Active measurement (injection by the C.A 6472) Passive measurement (use of disturbance currents) Sensor turns: 1, 2, 3 or 4 Sensitivity selector: x 10, x 1, x 0.1 Current measurement: 0.1 mA to 99.9 A
Measurement range	0.001 $\Omega$ to 99.99 k $\Omega$
Accuracy	$\pm$ (5 % + 1 count)
Frequency	41 to 5,078 Hz
Frequency sweep	Yes
Other features	
Power supply / Storage / Display	Provided by the C.A 6472
Dimensions / Weight	260 x 240 x 120 mm / 2.3 kg

## Reference to order

> **C.A 6474** ..... **P01126510**

Delivered with a carrying bag for accessories containing: one C.A6472-C.A6474 connection lead, 6 BNC/BNC cables 15 m long, 4 AmpFLEX™ flexible current sensors 5 m long, 1 set of 12 AmpFLEX™ identification rings, 2 cables (5 m green, 5 m black) with safety connectors on winder, 5 spade lug/banana plug converters  $\varnothing$  4 mm, 3 adjustable clamps, 1 calibration loop, 5 operating manuals and 5 specification labels, each in a different language.



By using AmpFLEX™ sensors, you can measure on any pylon configuration.

## Accessories / Spares

- C.A 6472 – C.A 6474 connection cable ..... P01295271
- 15 m BNC/BNC cable ..... P01295272
- 5 m AmpFLEX™ flexible current sensor ..... P01120550
- Set of 12 AmpFLEX™ identification rings ..... P01102045
- Set of 3 adjustable clamps ..... P01102046
- 5 m green cable (E terminal connection) ..... P01295291
- 5 m black cable (ES terminal connection) ..... P01295292
- Spade lug/banana plug adapters ..... P01102028
- Calibration loop ..... P01295294
- AmpFLEX™ flexible current sensors:  
other lengths are available on request

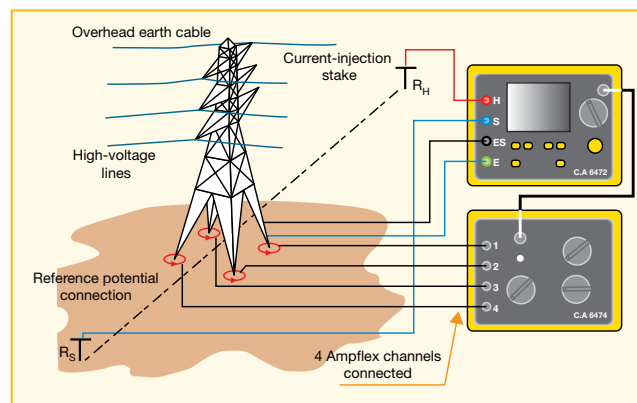

Pylon earth resistance measurement using the C.A 6472 and C.A 6474

## Earth resistance and soil resistivity accessories

*Chauvin Arnoux proposes high-quality accessories for your earth resistance and/or soil resistivity measurements. Ingenious colour coding of the cables and terminals helps to ensure error-free connections.*

*The cable lengths are specially designed to suit the applications for which our kits are intended. For easy handling during installation, the cable reels are equipped with handles which can be removed when the accessories are stored.*

*These kits are compatible with all our instruments, whatever their connection technology, thanks to the banana plug-spade lug adapters supplied. These adapters allow universal use of these accessories, whatever the method used.*

*All the accessories, earth stakes, cables, reels, crocodile clips, etc., can be transported easily in a single compartmented bag.*



**Earth kit:**  
 for measuring existing earth resistances using the 3-pole method (Standard carrying bag)



**Earth and resistivity kit:**  
 earth resistance and soil resistivity measurements using any method (Prestige carrying bag)

Composition		
<i>Earth resistance 1-pole loop kit</i>		Comprising 1 x 30 m green cable reel, 1 T-rod
<i>Earth resistance 3-pole earth kit</i>	50 m	Comprising 2 T-rods, 2 cable reels (50 m red, 50 m blue), 1 cable winder (10 m green), 1 mallet, 5 spade lug / Ø 4 mm banana plug adapters, 1 carrying bag
	100 m	Comprising 2 T-rods, 2 cable reels (100 m red, 100 m blue), 1 cable winder (10 m green), 1 mallet, 5 spade lug / Ø 4 mm banana plug adapters, 1 carrying bag
	150 m	Comprising 2 T-rods, 2 cable reels (150 m red, 150 m blue), 1 cable winder (10 m green), 1 mallet, 5 spade lug / Ø 4 mm banana plug adapters, 1 carrying bag
<i>Earth and resistivity kit – 4-pole</i>	100 m	Comprising 4 T-rods, 4 cable reels (100 m red, 100 m blue, 100 m green, 30 m black), 1 cable winder (10 m green), 1 mallet, 5 spade lug / Ø 4 mm banana plug adapters, 1 prestige carrying bag
	150 m	Comprising 4 T-rods, 4 cable reels (150 m red, 150 m blue, 150 m green, 30 m black), 1 cable winder (10 m green), 1 mallet, 5 spade lug / Ø 4 mm banana plug adapters, 1 prestige carrying bag
<i>Resistivity add-on kit</i>	100 m	Comprising 2 cable reels (100 m green and 30 m black), 1 standard carrying case, 2 T-rods
<i>C.A 647X continuity bound test kit (µΩ position)</i>		Comprising 4 x 1.5 m cables terminated by Ø 4 mm banana plugs, 4 crocodile clips, 2 test probes

## References to order

- > 1P loop kit ..... P01102020
- > 50 m 3P earth kit ..... P01102021
- > 100 m 3P earth kit ..... P01102022
- > 150 m 3P earth kit ..... P01102023
- > 100 m earth and resistivity kit ..... P01102024
- > 150 m earth and resistivity kit ..... P01102025
- > Resistivity add-on kit (100 m) ..... P01102030
- > C.A 647X continuity bound test kit ..... P01102037  
(µΩ position)

## Accessories / Spares

- > For earth and resistivity kits:
- 10 m H-shaped green cable winder..... P01102026
- Set of 5 adapters for terminals ..... P01102028
- Set of 4 reel handles..... P01102029
- 1 earth T-rod..... P01102031
- C172 current clamp..... P01120310
- 166 m red cable reel ..... P01295260
- 100 m red cable reel ..... P01295261
- 50 m red cable reel ..... P01295262
- 166 m blue cable reel..... P01295263
- 100 m blue cable reel..... P01295264
- 50 m blue cable reel ..... P01295265
- 100 m green cable reel..... P01295266
- 33 m black cable reel ..... P01295267
- 33 m green cable reel ..... P01295268
- Standard carrying bag ..... P01298066
- Prestige carrying bag ..... P01298067

## Earth clamps

### C.A 6410, C.A 6412 & C.A 6415

*In addition to providing the traditional earth resistance tests, the C.A 6410, C.A 6412 and C.A 6415 earth clamps are both quick and safe: measurement is carried out on the electrical installation without disconnecting the earth bar and no auxiliary stakes are needed. Designed for easy handling and simple use by clamping, they are also capable of measuring the leakage currents draining to earth. Each clamp, delivered in a carrying case, is a functional tool ideal for electrical maintenance.*

#### Ergonomics

- Simple earth resistance testing
- Rugged clamp design for intensive use in the field
- Clamp ergonomics specially designed for easy handling
- Indication of faults (disturbance current or incorrect closure) by symbol display
- 3,000-count LCD screen
- Smooth jaw interface surfaces

#### Measurements

- Earth loop measurement: 0.1 to 1,200  $\Omega$
- Direct measurement of leakage currents from 1 mA to 30 A (C.A 6412 & C.A 6415)
- Storage of up to 99 measurement results (C.A 6415)
- Configurable alarms (C.A 6415) for quick tests
- High immunity to electrical noise for use near distribution lines or substations

#### Power supply

- Battery powered
- Battery life of up to 1,000 measurements lasting 30 seconds each



C.A 6410



C.A 6412



C.A 6415



#### Head construction:

The measurement head is the key component of the earth clamp, guaranteeing high product performance. Chauvin Arnoux® earth clamps are built with two independent, shielded magnetic circuits for excellent measurement noise rejection. The mechanical design ensures stable, repeated jaw alignment, thus guaranteeing measurement accuracy. The smooth finish of the contact surfaces prevents the accumulation of particles which might affect the measurements.

	Measurement range	Resolution	Accuracy
<b>Specifications</b>			
Earth resistance	0.00 to 1.00 $\Omega$	0.01 $\Omega$	$\pm 2\%$ $\pm 2$ counts
	1.0 to 50.0 $\Omega$	0.1 $\Omega$	$\pm 1.5\%$ $\pm 1$ count
	50.0 to 100.0 $\Omega$	0.5 $\Omega$	$\pm 2\%$ $\pm 1$ count
	100 to 200 $\Omega$	1 $\Omega$	$\pm 3\%$ $\pm 1$ count
	200 to 400 $\Omega$	5 $\Omega$	$\pm 6\%$ $\pm 1$ count
	400 to 600 $\Omega$	10 $\Omega$	$\pm 10\%$ $\pm 1$ count
	600 to 1,200 $\Omega$	50 $\Omega$	$\pm 25\%$ $\pm 1$ count
Measurement frequency	2403 Hz		
Current / leakage current (C.A 6412 & C.A 6415)	1 to 299 mA	1 mA	$\pm 2.5\%$ $\pm 2$ counts
	0.300 to 2.999 A	0.001 A	$\pm 2.5\%$ $\pm 2$ counts
	3.00 to 29.99 A	0.01 A	$\pm 2.5\%$ $\pm 2$ counts
Current measurement frequency	47 to 800 Hz		
Indication of disturbance currents and incorrect closure	By symbol displayed on LCD		
Alarm (C.A 6415)	User configurable		
Storage (C.A 6415)	99 measurements		
<b>Other features</b>			
Power supply	9 V battery		
Display	3,000-count LCD		
Electrical safety	IEC 61010 - CAT III 150 V		
Dimensions / Weight	55 x 100 x 240 mm / 1 kg		

## References to order

- > C.A 6410 ..... P01122011
- > C.A 6412 ..... P01122012
- > C.A 6415 ..... P01122013

Each earth clamp is delivered in a carrying case with a 9 V battery and an operating manual in 5 languages

## Accessories / Spares

- Calibration loop..... P01122301
- MLT 100 carrying case ..... P01298011
- 9 V alkaline battery ..... P01100620
- 9 V alkaline batteries (x 12)..... P01100620A
- 9 V alkaline batteries (x 24)..... P01100620B



# The European leader in measurement

Three complementary businesses, global expertise

Chauvin Arnoux's role as a French instrument manufacturer and its work to implement energy management and control systems place it at the heart of the electrical measurement business and the Group is now acknowledged as a major player in the electrical sector, as well as a leader in the temperature measurement market.

Designing new and better ways to "measure" the future every day

From transformation of the raw materials through to after-sales service, our teams strive to innovate every day in order to provide a global solution meeting the needs of cutting-edge industries, tertiary infrastructures and self-employed electricians.

Visit us at:

[www.chauvin-arnoux.com](http://www.chauvin-arnoux.com)

Check out our online product catalogs:

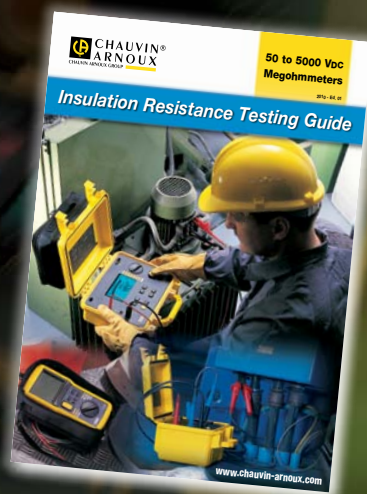

Your distributor

**FRANCE**  
**Chauvin Arnoux**  
190, rue Championnet  
75876 PARIS Cedex 18  
Tel.: +33 1 44 85 44 38  
Fax: +33 1 46 27 95 59  
export@chauvin-arnoux.fr  
www.chauvin-arnoux.fr

**UNITED KINGDOM**  
**Chauvin Arnoux Ltd**  
Unit 1, Nelson Court  
Flagship Square, Shaw Cross Business Park  
Dewsbury, W. Yorkshire WF12 7TH  
Tel.: +44 1924 460 494  
Fax: +44 1924 455 328  
info@chauvin-arnoux.co.uk  
www.chauvin-arnoux.co.uk

**MIDDLE-EAST**  
**Chauvin Arnoux Middle East**  
P.O. BOX 60-154  
1241 2020 JAL EL DIB  
LEBANON  
Tel.: +961 1 890 425  
Fax: +961 1 890 424  
camie@chauvin-arnoux.com  
www.chauvin-arnoux.com

**SCANDINAVIA**  
**CA Mätssystem AB**  
Box 4501 - SE 18304 TÄBY  
Tel: +46 8 50 52 68 00  
Fax: +46 8 50 52 68 10  
info@camatsystem.com  
www.camatsystem.com

 **CHAUVIN  
ARNOUX**  
GROUP