

# ABB drives

Using variable speed drives (VSDs)  
in pump applications





# Contents

---

<b>Chapter 1 - Introduction .....</b>	<b>5</b>
<b>Chapter 2 - The basic function of pumps .....</b>	<b>6</b>
Centrifugal pumps .....	6
Terminology in this section .....	7
Common terms .....	7
Pump curves .....	7
Affinity laws .....	8
<b>Chapter 3 - Pumping system .....</b>	<b>9</b>
Pump as a part of the process .....	9
Different flow control methods .....	9
Throttling .....	10
Bypassing .....	10
On-off control .....	11
VSD control .....	11
Parallel and serial pumps .....	12
Selection of pump, motor and variable speed drive (VSD) .....	12
Pump selection .....	12
Motor and variable speed drive selection .....	14
<b>Chapter 4 - Variable speed drive benefits with pump applications .....</b>	<b>15</b>
Life cycle cost (LCC) .....	15
Energy saving .....	16
Software for energy savings calculation .....	18
Low maintenance and repair cost .....	19
Additional benefits with VSDs .....	19
<b>Chapter 5 - Applying variable speed drives to pumping applications ...</b>	<b>21</b>
Process control parameters .....	21
Clean water applications .....	22
Pressure control .....	22
Level control .....	23
Temperature control .....	24
Case example: pressure boosting station .....	24
Wastewater applications .....	26
Level control .....	26
Anti-jam .....	27
Prevention of tank wall sedimentation .....	27
Flush effect .....	28

Case example: Storm water pumping station .....	28
Additional functions .....	29
Flow calculation function .....	29
Pump priority function .....	30
Sleep boost function .....	30
Adaptive programming .....	30
Remote data access and monitoring via the Internet .....	30
<b>Chapter 6 - Bibliography .....</b>	<b>32</b>
<b>Chapter 7 - Symbols and definitions .....</b>	<b>33</b>
Definitions .....	33
<b>Index .....</b>	<b>35</b>

# Chapter 1 - Introduction

---

The purpose of this Application guide is to give design and project engineers and any other interested parties the basic information for selecting the correct variable speed drive (VSD) system for pump installations in industrial, public and domestic applications.

Pumps are one of the most common variable speed drive (VSD) system applications and special interest has focused on improving their energy efficiency by using variable speed control instead of throttling or other less efficient flow control methods.

Pumps are the single largest user of electricity in industry in the European Union, consuming 160 TWh per annum of electricity and accounting for 79 million tonnes of carbon dioxide (CO<sub>2</sub>) emissions.

The content of this guide has been kept as practical as possible, without going into too much theoretical depth. The symbols and definitions used are explained at the end of this document.

# Chapter 2 - The basic function of pumps

---

The purpose of pumps is to transfer liquids from a source to a destination. A common example is filling a high level reservoir or increasing liquid pressure. Other examples are filling a pressurized tank or circulating liquid around a system as a means of heat transfer.

There are two main categories of pumps:

- Centrifugal (rotodynamic) pumps
- Positive displacement pumps

This Application guide focuses on centrifugal pumps. These account for 80% of all industrial pumps.

## Centrifugal pumps

The centrifugal pump (Figure 1.) is a mechanical device for increasing the pressure of liquid. In passing through the pump, the liquid is accelerated in the impeller, discharging into the casing at high velocity. This energy used is converted into pressure of the liquid as effectively as possible.

*Source: Variable speed pumping, Europump and Hydraulic Institute, 2004*

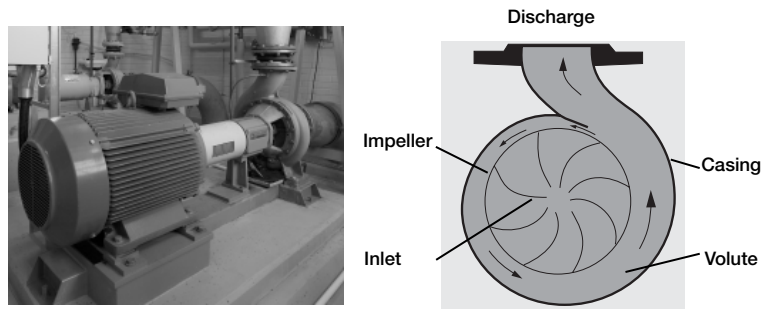

*Figure 1. Centrifugal pump: the most common pump type in industry and public utilities.*

## Terminology in this section

### Common terms

Before describing how a pump operates, it is useful to understand some key terminology:

**Head** - The net work done on a unit weight of water by the pump impeller. It is the amount of energy added to the water between the suction and discharge sides of the pump. Pump head is measured as pressure difference between the discharge and suction sides of the pump.

**Static head** - The vertical distance from the water level at the source to the highest point where the water must be delivered. It is the sum of static lift and static discharge. Static head is independent of the system discharge and is constant for all values of discharge. However, it is possible that the static head may vary over time due to the changes in the system.

**Operating point** - A centrifugal pump can operate at a combination of head and discharge points given by its pump curve (see below). The particular combination of head and discharge at which a pump is operating is called the pump's operating point. Once this point is determined, brake power, efficiency, and net positive suction head required for the pump can be obtained from the set of pump curves.

### Pump curves

The pump curves in Figure 2 show the technical performance of the pump. The horizontal axis shows the flow rate and the vertical axis shows the head and power generated.

A system curve, normally plotted together with the pump curve describes the static head and resistance of the pipeline. The operating point of the pump is at the intersection of the system curve and the pump curve.

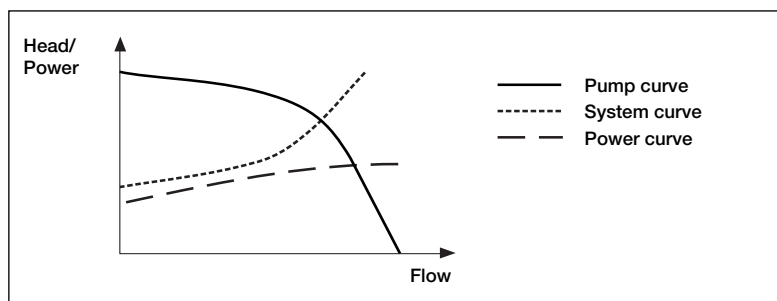

Figure 2. Pump performance curves.

## Affinity laws

As stated before, pumps are mechanical devices for increasing the pressure of liquid.

The affinity laws (Table 1) below describe the relation between the rotational speed of the pump ( $n$ ), flow rate ( $Q$ ), head generated ( $H$ ) and power absorbed ( $P$ ).

Speed and flow are directly proportional - Flow	$\frac{Q_1}{Q_2} = \frac{n_1}{n_2}$
Head is proportional to the square of the speed - Head	$\frac{H_1}{H_2} = \left(\frac{n_1}{n_2}\right)^2$
Power is proportional to the speed or flow cubed - Power	$\frac{P_1}{P_2} = \left(\frac{n_1}{n_2}\right)^3$

Table 1: Affinity laws



# Chapter 3 - Pumping system

---

## Pump as a part of the process

When in use, the pumps are always part of a pumping system. A pumping system is usually a network of pipes, tanks, valves and other system parts. The receiver is usually at a higher geographic level than the supply of the system. These parts can be also on the same level, as in the case of a closed circuit heat transfer system.

Pumping systems nearly always require a variation of flow rate. Examples include the daily cycle in the consumption of drinking water, the varying process demand for a liquid or seasonal heating demand. However, the variation required may be in the pump head, such as for cyclical changes in process pressure, or pumping to tanks with a variable liquid level.

In spite of the variations, the pump capacity is selected according to the maximum flow and head or even to the future needs, perhaps with a certain safety margin.

The average pumping capacity may be only a fraction of the maximum capacity and this will require some kind of control.

## Different flow control methods

There are several different methods to match the flow to the system requirements. The most common flow control methods of pumps are throttling, bypassing, on-off control and VSD control. These are illustrated in Figure 3.

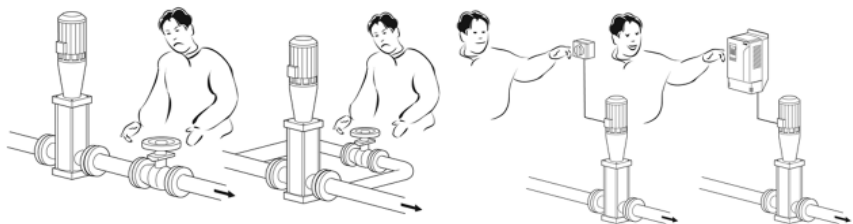

*Figure 3. Illustrations of pump flow control methods. Left to right: throttling, bypassing, on-off control and VSD control.*

The relative power consumption of the different control methods can be estimated from the area between the x and y-axes and the operating point. It is using the formula  $P=Q \times H$ .

In the following example, Figure 4, the relative power consumption on an average flow rate of 70% is calculated with different control methods. More detailed explanations on power consumption and energy savings relating to different pump applications are described in the following chapters.

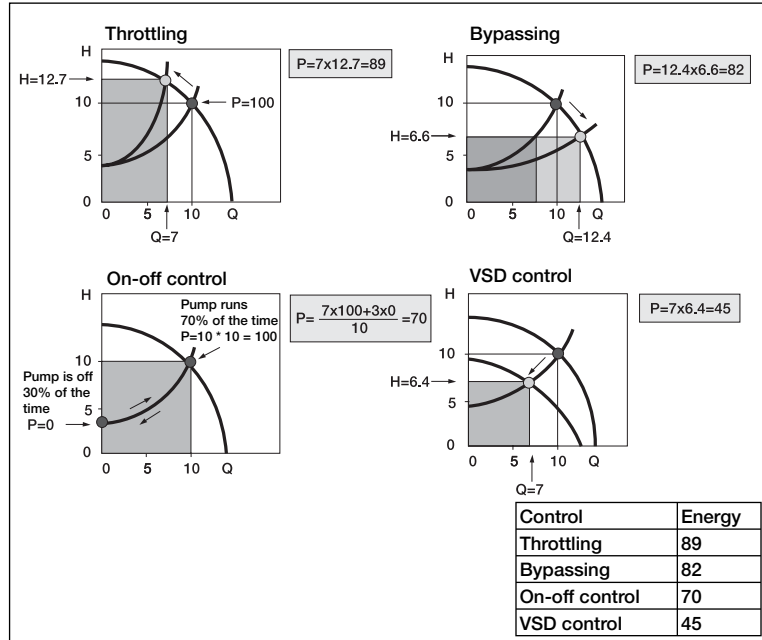

Figure 4. The power consumption of the four most common flow control methods for centrifugal pumps.

## Throttling

Throttle control is the most commonly used method. The flow caused by the constant speed pump is reduced by increasing the losses in the system by closing the valve. In the example in Figure 4 the operating point is moved from  $(Q = 10, H = 10)$  to  $(Q = 7, H = 12.7)$ . The relative power consumption can be calculated by  $P = 7 \times 12.7 = 89$ .

## Bypassing

Although not commonly used, bypassing is applied mainly to circulation pumps. The flow output to the system is reduced by bypassing part of the pump discharge flow to the pump suction. This means that the total flow increases (from 10 to 12.4), but the head decreases (from 10 to 6.6). The relative power consumption is  $P = 12.4 \times 6.6 = 82$ .

## On-off control

On-off control is often used where stepless control is not necessary, such as keeping the pressure in a tank between preset limits. The pump is either running or stopped. The average flow is the relationship between the “on” time and the “total” time (on+off). The relative power consumption can be easily calculated by  $P = 0.7 \times 100 = 70$ .

## VSD control

To understand the benefits of VSD control consider to the pump curves in Figure 4. With low static head systems, the optimal efficiency of the pump follows the system curve. With VSD control, the duty point of the pump follows the unchanged system curve. Changing the speed of the pump moves the pump curves in accordance with the affinity laws. If the pump impeller speed is reduced, the pump curve moves downwards. If the speed is increased, it moves upwards. This means that the pumping capacity is exactly matched to the process requirements. According to our earlier example both flow rate (from 10 to 7) and head (from 10 to 6.4) are reduced. The relative power consumption can be calculated by  $P = 7 \times 6.4 = 45$ .

This example shows that the variable speed control method is the most energy efficient for pumping applications. The examples discussed were calculated for one flow rate only (70%), but the relative power consumption with different control methods depends on the flow rate. This relationship is shown in Figure 5. In these curves, the pump, motor and drive efficiencies are also taken into account and for that reason the results differ somewhat to those in Figure 4.

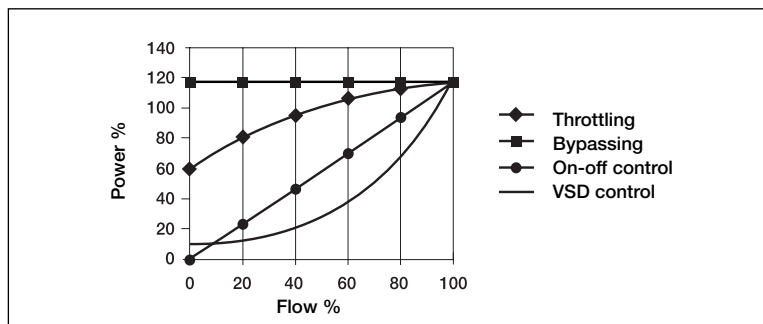

Figure 5. Power consumption with different pump control methods as a function of flow rate. The percentage values of flow and power are related to the nominal values of the pump.

Throttling control leads to high loss in the pump and in the valve when the system is running at a reduced flow rate. The loss in the motor remains relatively constant over the whole flow range. In VSD control, the operating point follows the system

curve, which is optimal for pump efficiency. In general, based on affinity laws, the energy consumption drops dramatically when speed is reduced. The energy savings with VSD control are significant.

## Parallel and serial pumps

If the available flow capacity with a single pump is not sufficient, parallel connection of two or more pumps is possible. It is important to install back pressure valves for all parallel pumps, to avoid backwards flow through the pumps.

With parallel pump installation the redundancy of the system is much higher. If one of the pumps is lost in the system, other pumps can take its place and continue operation. Downtime is very limited, depending on how fast the replacement is carried out. With ABB industrial drives the parallel connection of drives detects faulty units and makes any necessary corrections in the control loop in less than one second.

Serial connection of pumps can be used in high-pressure system applications, for example where one pump cannot produce the head required.

## Selection of pump, motor and variable speed drive (VSD)

The selection of pumps, motors and drives is based on the process information. Sometimes the information can be simply: *“We need to pump water at 300 l/s, please quote for a pump”*.

Even though the pump is a simple machine, proper pump selection calls for more input data. There are many selection tools to support the dimensioning of pumps, motors and drives.

The motor and VSD are dimensioned to run the pump under normal pump operation conditions.

## Pump selection

The general requirements for pump selection are:

- Working conditions
- Capacity, suction and discharge pressures with variation ranges
- Maximum differential pressure for the pump casing
- Exceptional starting, stopping and other running conditions
- Liquid specification with density, temperature etc.
- Suction conditions such as suction head, suction pipe losses etc.
- Pump construction material

- System description, e.g. single, parallel or serial connection with some other pump
- Special conditions in the mounting space

The required capacity can often be achieved by several different pump types with the same or different speed. The selection has to be made, for instance, between a higher speed pump with low initial cost and a lower speed pump with lower maintenance costs. The use of pump curves, as printed in a manufacturer's catalogue, is shown in Figure 6.

For example, to select a pump for a before mentioned quote "We need to pump water at 300 l/s, please quote for a pump" the selection steps are the following.

1. find the required flow, 300 l/s
2. move upwards to match the required head, 30 m
3. the required performance is achieved with pump of 1400 rpm speed
4. to see the power needed move down to the lower curve set along with 300l/s line
5. when crossing the 1400 rpm curve move to left to read the power needed at the operating point (110 kW)

The selected pump is the smallest capable for the operating point required. If we know that there is no need for higher capacity, either now or in the future, there is no need to choose a bigger pump. The bigger pump leads to higher initial and operating costs.

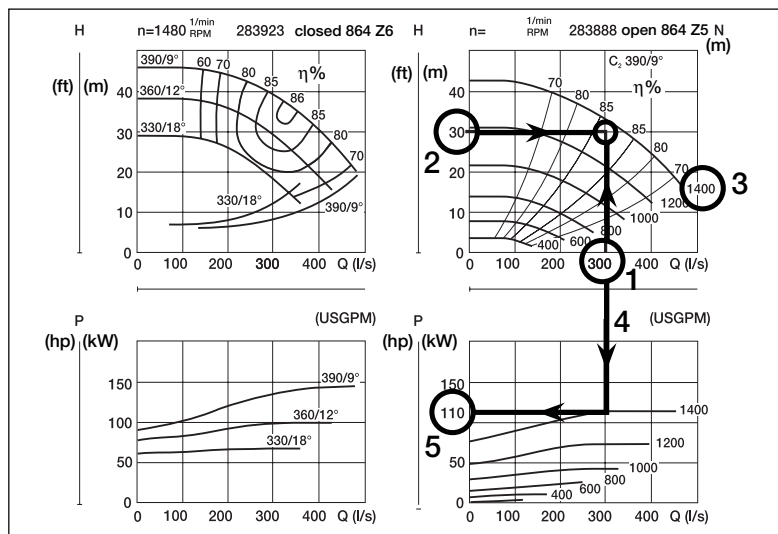

Figure 6. An example of pump curves. Left: Pump with three different impeller diameters. Right: Pump with six different speeds.

For the variable speed application example above, a motor selection can be made for 110 kW/1400 rpm.

## Motor and variable speed drive selection

Motor and drive manufacturers have developed software tools for motor and drive selection. ABB has a DriveSize tool, which can be used for the pump case above. The results are similar to manual selection. The tool has a database of ABB motors, drives and transformers so its output is an exact selection with type designations. The DriveSize tool can be downloaded from the Internet at [www.abb.com](http://www.abb.com), and then entering “DriveSize” in the search box.

Figure 7 shows an example of DriveSize 2.5 motor selection. Because the pump loading torque is very low at lower speeds, the maximum torque is critical for motor selection. In this case we need to check that the motor torque ( $T_m$ ) at 1400 rpm is higher than the pump torque ( $T_p$ ).

$$T_p = \frac{9550 \times P_p}{n} = \frac{9550 \times 110 \text{ kW}}{1400 \text{ rpm}} = 750 \text{ Nm}$$

As a result, the pump torque is 750 Nm. In this case the selected motor M3BP 315 SMB 4 has 848 Nm torque.

Motor load			Selected motor data	
Load type	Pump/fan load		Selection: DriveSize	
Overload type	Simple cyclic		Type code: M3BP 315 SMB 4	
	min	base	Product code: 3GBP 312 220 (F1)	
Speed [rpm]	1400	1400	Voltage [V]	400
Power [kW]	110	110	Frequency [Hz]	50
Overload [%]			Power [kW]	132
			Poles	4
			Speed [rpm]	1487
Overload time [s]	10	every [s]	Max mech. speed [rpm]	2300
		600	Current [A]	232
			Torque [Nm]	848
			Tmax/Tn	2,7
			Power factor	0,86
			Efficiency [%]	95,8
			Temperature rise class	B
			Insulation class	F
			Inertia [kgm <sup>2</sup> ]	2,6
Specifications				
Name	[undefined]			
Motors per inverter	1			
Motor type	Auto selection			

Figure 7. The selection window of DriveSize 2.5.

DriveSize also selected a suitable VSD for the pump, which is ACS800-02-0170-3.

# Chapter 4 - Variable speed drive benefits with pump applications

---

Pumping applications represent a significant opportunity for applying VSDs in new, as well as retrofit installations. The majority of pumping applications need to be controlled. It is unlikely that a pump will run continuously at a maximum speed.

VSDs are crucial when limiting the life cycle costs (LCC) of a pump station. The three main costs are energy, initial investment and maintenance.

Many analyses show that energy consumption is the dominating element of the LCC, especially if pumps run more than 2,000 hours per year. The investment cost of the equipment needed (variable speed drives, motors and pumps) is relatively low when compared to the total LCC. Maintenance is the third main cost component. Active control using a VSD works as a means of preventive maintenance, limiting maintenance costs in many ways.

VSD control has several benefits in pumping systems. The most important is energy saving. Accurate control of the pump system is another benefit. With VSDs running the pump system, linking to other automation systems is easy by means of common fieldbus gateways.

The following chapters give more detailed descriptions of these benefits.

## Life cycle cost (LCC)

LCC analysis is a method of calculating the cost of a system over its entire life span. The analysis of a typical system includes initial costs, installation and commissioning costs, energy, operation, maintenance and repair costs as well as down time, environmental, decommissioning and disposal costs.

Many organizations only consider the initial purchase and installation cost of a system. It is in the interest of the plant designer or manager to evaluate the LCC of different solutions before installing major new equipment or carrying out a major overhaul. This evaluation will identify the most financially attractive alternatives. As national and global markets continue to become more competitive, organizations must continually seek cost savings that will improve the profitability of their operations. Plant equipment operations are receiving particular attention as a source of cost savings, especially minimizing energy consumption and plant downtime.

In addition to the economic reasons for using LCC, many organizations are becoming increasingly aware of the environmental impact of their businesses and are considering energy efficiency as one way to reduce emissions and preserve natural resources.

*Source: Pump Life Cycle Costs, Hydraulic Institute, Europump, 2000*

Life cycle analysis for pumping systems show that:

- 5% of industrial energy goes to pumps
- 90% of the total cost of owning a pump comes from energy consumption
- Pump energy consumption can generally be reduced up to 20%

Good guidance for Pump Life Cycle Cost is available from [www.pumps.org](http://www.pumps.org). An LCC Analysis for Pumping Systems has been developed by the Hydraulic Institute (HI), Europump and the US Department of Energy's Office of Industrial Technologies (OIT)

The website also includes information related to variable speed pumping and energy savings.

## **Energy saving**

The Hydraulic Institute and Europump have jointly published a book entitled "Variable Speed Pumping: A Guide to Successful Applications" which details seven ways to save energy:

- 1) Design systems with lower capacity and total head requirements. Do not assume these requirements are fixed.
- 2) Avoid allowing for an excessive margin of error in capacity and/or total head. It typically will be less expensive to add pumping capacity later if requirements increase.
- 3) Despite the tendency to emphasize initial cost, you will save in the long run by selecting the most efficient pump type and size at the onset.
- 4) Use VSDs to avoid losses from throttle valves and bypass lines, except when the system is designed with high static heads.
- 5) Use two or more smaller pumps instead of one larger pump so that excess pump capacity can be turned off.
- 6) Use pumps operating as turbines to recover pressure energy that would otherwise be wasted.



- 7) Maintain pumps and all system components in virtually new condition to avoid efficiency loss.

The energy efficiency of a pumping system depends on the control method used. The VSD is especially efficient when the pump is running with partial flow. A typical example of the duty cycles of a pumping application is shown in Figure 8.

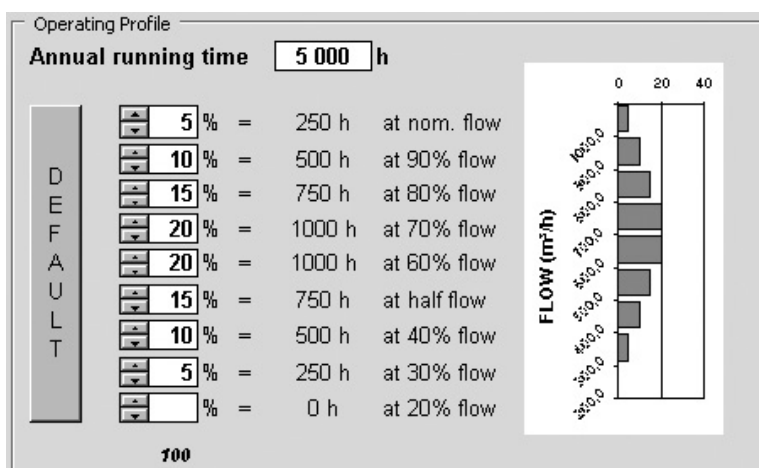

Figure 8. A typical operating profile of a pumping system as presented in PumpSave, ABB's energy saving calculation tool.

The earlier energy saving calculation example (see page 13) is below calculated with PumpSave, ABB's energy saving calculation tool. The following conditions exist:

**Pump data:** Nominal flow 1000m³/h (~300l/s)  
 Efficiency 85%  
 Static head 10m  
 Nominal head 30m  
 Max head 45m

**Motor data:** Motor power 110 kW  
 Motor voltage 400V  
 Nominal efficiency 96%

**Drive data:** Nominal efficiency 95%

**Economic data:** Energy price 0.05 EUR/kWh.

The energy consumed with throttling and VSD is illustrated below on Figure 9.

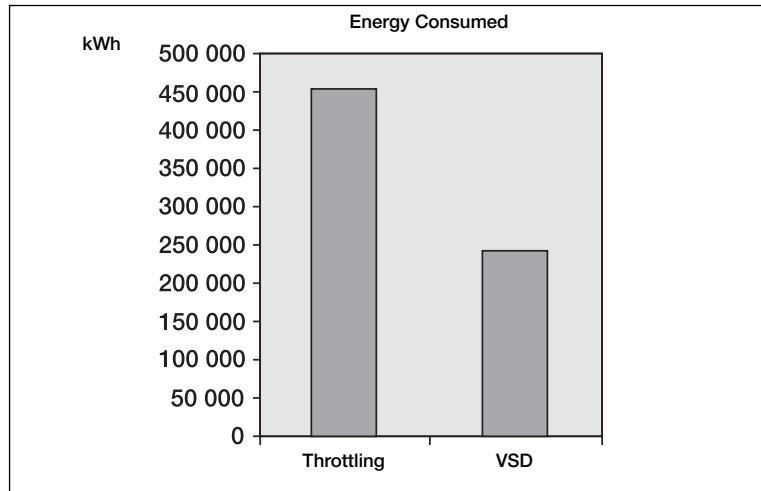

Figure 9. Energy consumption of a pump system controlled with throttling and VSD control as presented in PumpSave, ABB's energy saving calculation tool.

The total energy saving with the VSD compared to throttling is 202 MWh (46%). The financial savings amount to 10,100 EUR every year.

This calculation clearly shows the benefit of VSD control with regard to energy savings for a single pump.

## Software for energy savings calculation

ABB has developed a calculation tool called PumpSave, which estimates the energy savings when applying electric speed control to pump applications. To estimate the energy savings, a VSD can be compared to throttling control, on-off control and hydraulic coupling control.

The calculations are based on typical pump operating characteristics. The accuracy of the input data affects the accuracy of the results. Results should only be used for estimating purposes. The results of calculations can be printed out.

PumpSave carries out a simple dimensioning and recommends an appropriate ABB drive type. The tool provides financial figures for assessing the profitability of purchasing an ABB drive. PumpSave runs in Microsoft Excel. The PumpSave tool can be downloaded from [www.abb.com/motors&drives](http://www.abb.com/motors&drives) and then entering "PumpSave" in the search box. There is also a detailed user's manual for the PumpSave tool.

## Low maintenance and repair cost

Maintenance and repair costs are one of the main elements in the LCC analysis. The cost of unexpected downtime and lost production is a very significant item in the total LCC and can rival the energy costs. With VSDs, lower maintenance and repair cost is achieved through the following:

**Reduced water hammer effects.** Water hammer is caused by rapid changes in flow. These flow changes are followed by rapid pressure transients that cause pipes, pipe supports and valves to be damaged causing leakage. VSDs allow the user to gradually ramp the acceleration at a safe rate to avoid hammering.

**Reduced stress on electrical supply.** VSDs always start the pump motor softly with much lower peak current than direct-on-line starting that is used with other flow control methods.

**Reduced risk for cavitation.** Cavitation is a phenomenon that occurs whenever the static pressure drops below the liquid vapour pressure causing bubbles to collapse with a very high impact force. This force causes surface damage inside the pump. With a VSD it is possible to monitor the pressure of the incoming pipeline and take steps if the risk of cavitation is high.

**Redundancy.** With parallel pumps, each controlled with a VSD, there are two possibilities to minimize maintenance and repair costs. Parallel connection means that if one pump fails, the remaining pumps can continue uninterrupted. Another benefit is to control the running times of each pump to a predefined schedule. This enables the customer to optimize any service breaks, ensuring that there is always pumping capacity available.

## Additional benefits with VSDs

The use of VSDs has many other advantages in process control applications. These include:

**Harmonics.** In some countries, power companies set strict limits on the permissible harmonic content of current and voltage, in order to prevent damage to equipment in the same environment. In these situations, ABB low harmonic drives minimize offending harmonics, causing no harmful effect to the power grid, thereby avoiding penalties while ensuring maximum uptime for the pumping station.

**Easy communication.** ABB drives can connect to all major automation systems. This is achieved with a dedicated gateway concept between the fieldbus systems and ABB drives. The Ethernet module gives simple access to the drive via the

Internet, communicating via a standard web browser. The user can set up a virtual monitoring room wherever there is a PC with an Internet connection or via a simple dial-up modem connection. This enables remote monitoring, configuration, diagnostics and, when needed, control.

**Flexibility in pump selection.** Quite often it is difficult to estimate the system parameters in advance and therefore the safety margins used are too high. This causes additional operational costs if the required flow and head are lower than estimated. By using VSDs these over dimensioning problems can be resolved by running the pump at a lower speed.

**Reasonable investment cost.** VSDs have developed rapidly during the last 10 years. The cost of manufacture and subsequent cost of purchase has also fallen dramatically in recent years. Sometimes it can be less expensive to install a VSD than a control valve with a PLC system.

**Natural part of the control loop.** One big advantage in considering a VSD in comparison to a control valve is the elimination of deadband that a control valve introduces into loop performance.

# Chapter 5 - Applying variable speed drives to pumping applications

---

The majority of pumping applications need to be controlled. Changing the rotation speed of a centrifugal pump has an effect on the pump's volume flow, generated head and power consumption.

The design of a pumping system with VSDs requires knowledge about the process control parameters.

## Process control parameters

The parameters to be considered in clean water applications include:

- Inputs – heads and pressure required, flow and its variations, required level of the liquid
- Outputs – pressure generated, flow generated
- External influences – temperature change, change in flow, change of the liquid's properties, floating, breaking or jamming of the pipeline, change in the water consumption rate

The parameters to be considered in waste water applications include, accordingly:

- Inputs – level of the water, temperature, pH, flow
- Outputs – flow, optimum filling-/emptying time, adjustment of pH or temperature
- External influences – temperature change, change in flow, change of the liquid's properties, floating, breaking or jamming of the pipeline

Knowing the above requirements makes it easy to find the right parameter to be controlled and subsequently optimize the process.

VSD can handle several analogue and digital inputs and outputs to control and monitor the pumping process. The large number of fieldbus options makes it easy to incorporate the drives seamlessly into any automation system.

Some basic control loops in industrial and public pump applications are described later in this chapter.

## Clean water applications

Clean water applications require pumps to carry fresh water from the source (lake, well etc.) to the users (homes, industry etc.).

Clean water is often stored in tanks either before or after undergoing different chemical cleaning processes. Water is finally pumped to the users through pipelines with stable pressure.

Three different control examples for clean water applications are described below: pressure, level and temperature control.

“Additional functions” -section describes additional useful VSD functions. These functions are applicable for both clean and waste water applications.

### Pressure control

Using VSDs to control pressure reduces the electrical energy requirements by reducing the amount of hydraulic energy actually produced.

A basic pressure control pump station is equipped with one pump controlled by one VSD. In some pump stations, pumps connected in parallel are a more efficient solution. Several parallel pumps can be controlled with one VSD controlling the master pump and contactors switching the other pumps on and off. Figure 10 shows a set-up with parallel pumps using one ABB drive to control three pumps.

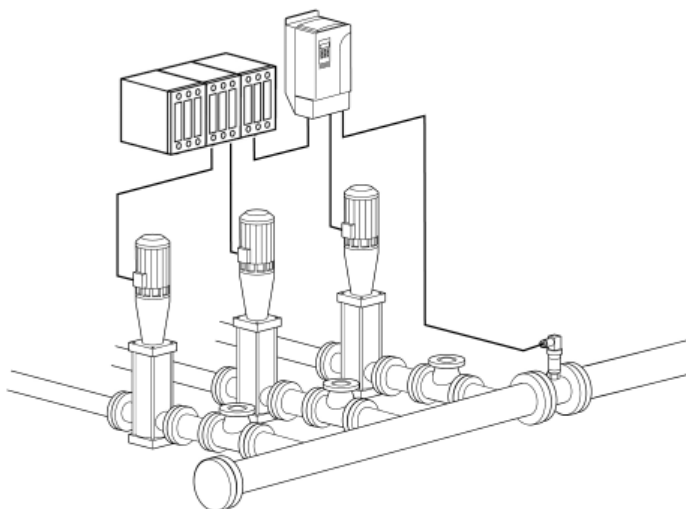

Figure 10. Pressure control of a pumping system with one variable speed drive (VSD).

To guarantee pump operation, even when a fault occurs, the pump system needs redundancy. In pump stations this means that a failure of one pump, motor or drive in a parallel installation does not cause a process interruption but the operation will continue with a limited capacity.

In order to have a replacement for a failed unit, a parallel system is needed. This means that each pump is controlled by an ABB industrial drive for pump control.

Drives share information such as status of the drive, priority, running time, process feedback, etc. through a fiber optic link. In a ring connection implemented with fiber optics it is possible to define the actions for the drives in the event of failure of the optical link in order to achieve 100% redundancy. No PLC is needed.

Figure 11 shows a system loop with three ABB industrial drives in ring connection controlling three pumps.

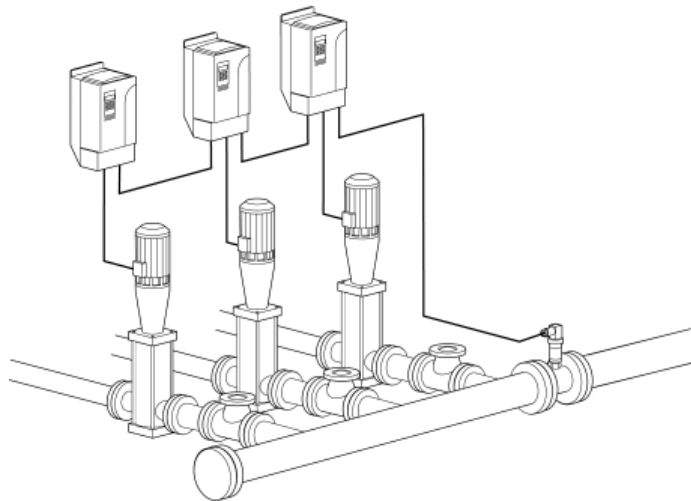

Figure 11. Pressure control with three ABB industrial drives.

## Level control

In many clean water applications, the level of the water is a required control function. In a typical level control loop, the level in the tank is controlled by throttling a control valve at the pump discharge. The flow through the pump will be between 25% and 75% of capacity. The significant hydraulic energy generated by the pump is dissipated across the control valve to regulate the level in the tank. The pump must be also dimensioned to accommodate the pressure drop associated with the valve at maximum flow.

Applying a VSD in the loop will control the pump to generate only the hydraulic energy needed to discharge the required amount of liquid. This approach reduces energy costs while lowering pump maintenance requirements. The net result is a system that reduces operating and maintenance costs by eliminating the need for a control valve, bypass piping and the associated energy losses. The level of the water tank can be controlled using PI control to maintain smooth but accurate level control with one or several pumps running in parallel.

## Temperature control

Figure 12 illustrates a control loop in which flow into a tank is regulated by the temperature of the tank content.

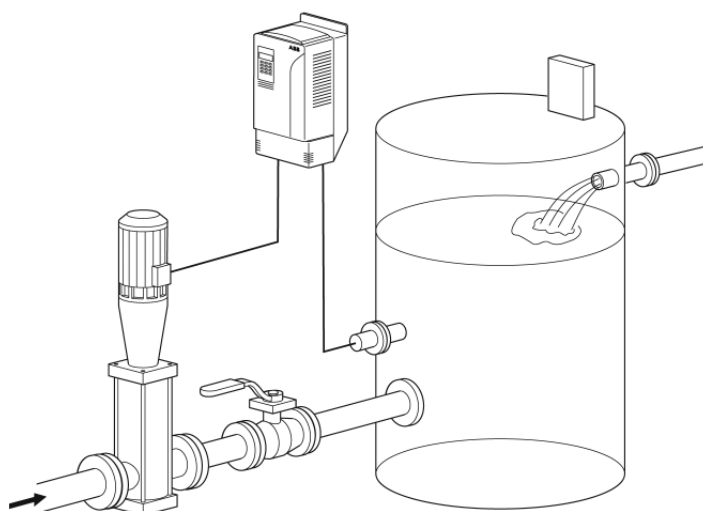

Figure 12. Temperature control with variable speed drive (VSD).

Temperature of the liquid is used to control the motor speed that regulates the flow to the tank. An on/off valve must be installed for safety reasons.

## Case example: pressure boosting station

The basic example of a clean water pump station is a pressure boosting station. It feeds water directly into the distribution system and seeks to maintain a constant pressure in the pipes. With smooth VSD control there are no pressure shocks causing noise, erosion or leakage in the pipeline.

Figure 13 shows a three pump parallel system at pressure boosting station in Pietarsaari, Finland. A water tower, which was the main storage facility before the construction of the tank



and pressure boosting station, now serves as a back-up. The pressure boosting station is equipped with 2 x 75 kW and 1 x 37 kW electric pumps. The station was recently upgraded with ABB industrial drives to operate the pumps.

Parallel drives enable the system to run with 100% redundancy. If a defect occurs in one of the pumps, motors or drives, the others will continue the operation without any interruption. Pump stations are sometimes located remotely and service activities might take some time. With redundancy, the pump station operation is trouble-free with minimized downtime.



*Figure 13. Pressure boosting station in Pietarsaari, Finland.*

The running time of the pumps can be stabilized with the pump priority function to ensure that the wear and tear of all pumps is the same. In some cases prioritization can use smaller pumps during light loading and bigger pumps during heavy loading, thereby maximizing energy use. In Pietarsaari the smaller 37 kW pump is used only at night time.

The flow calculation function enables the pumped volume to be monitored by the VSD, without any additional components. This is a very useful feature in systems where data about the total flow during a specific time period is needed. However, this is not deemed accurate enough for invoicing purposes. In Pietarsaari the flow measurement result of the drive is compared with the flow meter. The results are the same.

ABB industrial drives have enabled customers to reduce energy consumption by about 30%. The pressure in the system is much more stable, which has reduced leaks as well as maintenance needs.

## Wastewater applications

In this application, wastewater is transferred from the source (houses, drain wells and other collection points) to the sewage treatment plant.

Wastewater and rainwater contains solid particles, which have to be pumped. Actual pumping time and pressure are not important issues, but there must be sufficient capacity for special cases (heavy rain) and redundancy to handle situations when one or more pumps are out of order.

The collection points have tanks from where the wastewater is pumped to the treatment process. It is crucially important to have the right level in those tanks, as well as control over the pumps in order to keep the system operational at all times.

It is important to have stable process conditions in the treatment plant. However, this guide does not examine the wastewater treatment process in detail.

## Level control

Level control is typically used to control the filling or emptying of wastewater storage tanks. Single pump or parallel pumps operate at a favorable point most of the time to minimize energy consumption. Level control can be used with up to three pumps and drives in parallel. Figure 14 shows a typical single pump wastewater pump station.

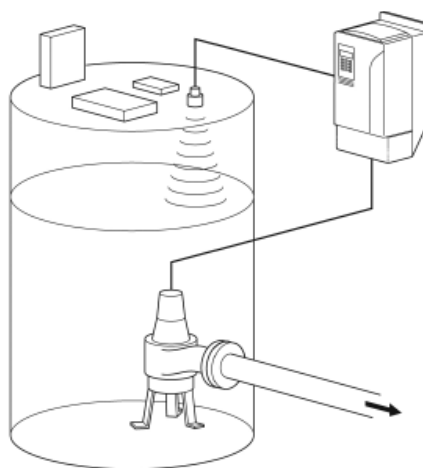

Figure 14. Level control set-up in a wastewater pump station with a single pump.

## Anti-jam

In applications where the pumped liquid contains small particles capable of jamming the pump, there is a need to have an active cleaning procedure for the pump, otherwise there is a risk of breaking the pump. Pump manufacturers recommend cleaning cycles for systems where the pump is running between maximum and minimum speeds with aggressive ramps in between. With an ABB industrial drive, this kind of cleaning sequence can be activated during motor jam, or during a specific run-on or run-off time. This is also a good example of preventive maintenance for the pump.

Anti-jam is an easy way to guarantee continuous pump operation in harsh environments.

## Prevention of tank wall sedimentation

In many pump applications there is a tank for liquid storage. With liquids containing particles, wall sedimentation (Figure 15, left tank) is a common problem if fixed levels are used when filling and emptying the tank.

A special software feature of ABB industrial drive is designed to prevent sediment build-up. Varying randomly the surface level within a range of preset limits, it is possible to avoid wall sedimentation. Manual tank cleaning can then be performed at longer intervals. Eliminating unnecessary stops for tank cleaning maximizes operating time.

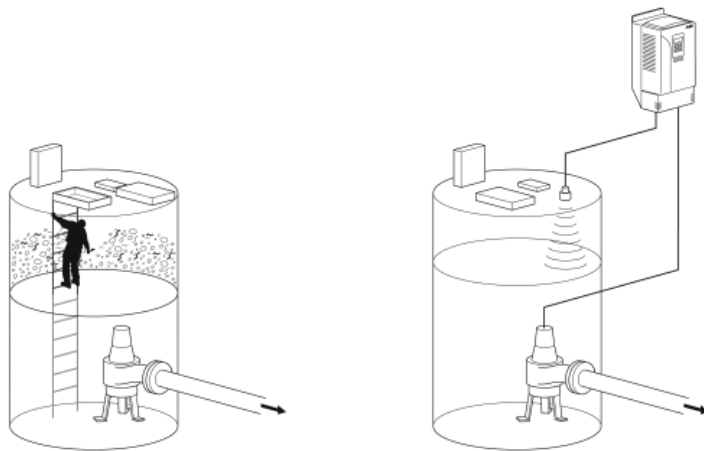

Figure 15. Ways to avoid wall sedimentation in a tank. Manual cleaning (left) and ABB industrial drive (right).

## Flush effect

When a liquid contains particles it affects the tank and pump as described above. Particles can also get jammed in pipelines and cause severe capacity problems and service breaks. These problems are avoided if the liquid and the particles are moved rapidly. Pump manufacturers advise avoiding very smooth control methods, especially with low flow speeds and when shutting down the pump. With a traditional VSD control, almost all pump speeds are accepted and changes in pump speed are smooth. With the ABB industrial drive only efficient speed and maximum speed are allowed in this kind of application – with a level control mode. Rapid changes between these stages and in starting give a powerful flush effect in the pipelines and in the pump itself, keeping them both clean.

## Case example: Storm water pumping station

Pietarsaari, Finland is a low-lying town, the centre of which can be prone to flooding during rainy weather. This was because the storm water removal system – consisting of pipes feeding into an open channel draining into the sea – did not have sufficient capacity for very rainy periods.

The local water utility, Pietarsaaren Vesi, decided to tackle these problems by increasing the capacity of the channel with an underground holding tank. A pumping station (Figure16) was constructed to empty the tank. Water is allowed to run into the tank until it reaches a trigger level and is then pumped out into the lower part of the channel where it continues to the sea. The pumping station has two 80 kW pumps operated by two ABB industrial drives.



Figure 16. The Pietarsaari storm water pumping station.

## Additional functions

The following useful functions are for clean water and wastewater applications. Some of these features are only available with ABB industrial drives.

### Flow calculation function

This function enables calculation of flow without the installation of a separate flow meter. The flow calculation function can measure the flow rate using two pressure transmitters or solely ABB industrial drive operating data. It helps to monitor the pumping process in single pump installation where the flow data is not required for invoicing purposes.

The flow measurement calculation is based on pump curves (PQ and HQ), pressure feedback from two sensors, data about the pump installation and Direct Torque Control (DTC) motor data. Sensorless flow measurement is also possible. For more accurate results, pressure transmitters can be used to supply the necessary measurement data. The connections are illustrated in Figure 17. An ABB industrial drive can then carry both actual and total flow information further to other automation systems.

The flow measurement function is also applicable for parallel pumps. There are some technical limitations due to the calculation formula. The pumps need to be the same size and they need to run at the same speed. It is also important that the pumps are connected to the same source and that the systems curves are equal.

*Flow calculation function is patented by ABB.*

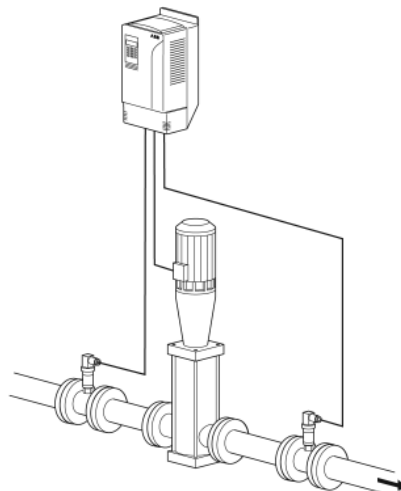

Figure17. Flow measurement connections.

## Pump priority function

This function balances the operating time of all the pumps in the system over the long term. This facilitates maintenance planning and can boost energy efficiency by operating pumps closer to their best efficiency point. In a system where the consumption rate is greater during the day, for instance, the drive can be programmed to operate higher capacity pumps during daytime and smaller units at night.

## Sleep boost function

The sleep boost function runs the pump to boost the pressure in the pipeline or water level in the tank prior to shutdown. This extends the pump's sleep time and therefore saves energy. It also avoids unnecessary starting and stopping and helps to flush the pipelines.

## Adaptive programming

A PI controller is a common way of controlling changing process variables. When the process PI control is activated, a process reference and actual value are compared. The process PI control adjusts the drive speed in order to keep the measured process quantity at the desired level. In a situation where the gap between reference and actual value is high – such as filling an empty pipeline in an irrigation system – the PI controller might be too aggressive when trying to stabilize the situation at the start. With ABB industrial drives it is possible to utilize adaptive programming to fine-tune specific conditions of this kind in different pump stations

## Remote data access and monitoring via the Internet

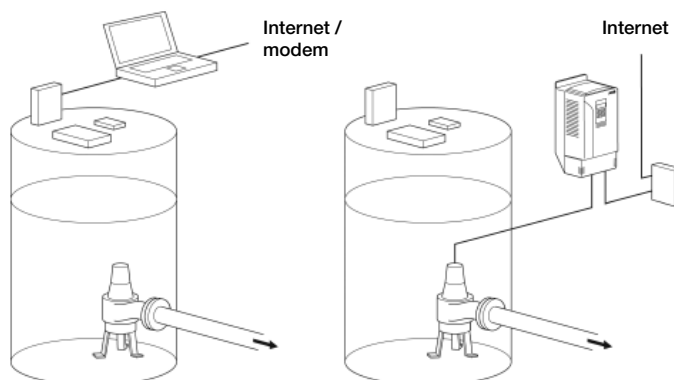

Figure 18. Different remote control methods for a pump station. With a separate computer (left) or with an ABB industrial drive and an intelligent ethernet module (right).

Pump stations are often located at a distance from the central controlling station. In this case the pump station can be equipped with the intelligent ethernet module that gives simple access to the drive via the internet, communicating via a standard web browser. The user can set up a virtual monitor wherever there is a PC with an internet connection or via dial-up modem connection. This enables remote monitoring of the drives and the process, configuration, diagnostic and, when needed, control.

The intelligent ethernet module also includes an alarm function which can provide additional confidence that the pumping station is operating correctly. Further continuous process data monitoring can be set up.

Up to nine drives can be connected to the ethernet adapter module supporting parallel connected pumps via fiber optic links.

## **Chapter 6 - Bibliography**

---

Variable speed pumping, Europump and Hydraulic Institute, 2004

Pump Life Cycle Costs, Hydraulic Institute, Europump, 2000



# Chapter 7 - Symbols and definitions

---

AC: Alternating current or voltage  
CO<sub>2</sub>: Carbon dioxide, gas  
DTC: Direct torque control  
EUR: Currency [euro]  
H: Head [m]  
HQ: Head Flow (pump performance curve)  
Hz: Hertz equals [1/s]  
I/O: Inputs and output  
LCC: Life cycle cost  
n: rotation speed [rotations per minute, rpm]  
kWh: Kilowatt hour  
P: Power [Watt, W]  
PI: Controller type  
PLC: Programmable logic controller  
PQ: Power Flow (pump performance curve)  
Q: Flow [l/s, m<sup>3</sup>/h]  
rpm: Rotations per minute  
TWh: Terawatt hour

## Definitions

**Head** - The net work done on a unit weight of water by the pump impeller. It is the amount of energy added to the water between the suction and discharge sides of the pump. Pump head is measured as pressure difference between the discharge and suction sides of the pump.

**Static head** - The vertical distance from the water level at the source to the highest point where the water must be delivered. It is the sum of static lift and static discharge. Static head is independent of the system discharge and is constant for all values of discharge. However, it is possible that the static head may vary with time due to the changes in the system.

**Operating point** - A centrifugal pump can operate at a combination of head and discharge points given by its pump curve. The particular combination of head and discharge at which a pump is operating is called the pump's operating point. Once this point is determined brake power, efficiency, and net positive suction head required for the pump can be obtained from the set of pump curves.

**Redundancy** – Serving as a duplicate for preventing failure of an entire system upon failure of a single component.

**Deadband** - Also known as hysteresis. The amount of a measured variable (pressure, temperature, etc.) between the point where a switch closes and then re-opens, i.e. an area of a signal range where no action occurs (the system is dead). Deadband is used in voltage regulators, thermostats, and alarms. The purpose is to prevent oscillation or repeated activation-deactivation cycles. Often the deadband of a switch is fixed and cannot be adjusted.

## **A**

Adaptive programming 4, 30  
Affinity laws 3, 8  
Anti-jam 3, 27

## **B**

Bypassing 3, 10, 11, 35

## **C**

cavitation 19  
centrifugal pump 6, 7, 21, 33

## **D**

deadband 20, 34  
Downtime 12  
DriveSize 14

## **E**

energy efficiency 5, 16, 17, 30  
Energy saving 3, 16  
Ethernet 19

## **F**

Flow calculation 4, 29  
Flush effect 3, 28

## **H**

hammer effects 19  
Harmonics 19  
Head 7, 8, 33  
hydraulic energy 22, 23, 24

## **I**

Internet 4, 14, 20, 30

## **L**

LCC 3, 15, 16, 19, 33  
Level control 3, 23, 26

## **M**

maintenance 3, 13, 15, 19, 24, 25,  
27, 30

## **O**

On-off control 3, 10, 11  
Operating point 7, 33

## **P**

parallel pumps 12, 19, 22, 26, 29  
PLC 20, 23, 33  
power 7, 8, 10, 11, 13, 17, 19, 21, 33  
Pressure 3, 22, 23, 25  
pressure boosting 3, 24, 25  
Pressure control 3, 22, 23  
pump curve 7, 11, 33  
Pump priority function 4, 30  
PumpSave 17, 18  
Pump selection 3, 12

## **R**

redundancy 12, 23, 25, 26  
remote control 30

## **S**

serial pumps 3, 12  
Sleep boost 4, 30  
Software 3, 18  
speed 5, 6, 8, 10, 11, 12, 13, 14, 3,  
15, 16, 17, 18, 19, 20, 21, 22, 23, 24,  
25, 26, 27, 28, 29, 30, 31, 32, 33  
Static head 7, 17, 33  
Storm water pumping station 4, 28  
system curve 7, 11

## **T**

tank 3, 6, 11, 23, 24, 27, 28, 30  
Temperature control 3, 24  
Throttling 3, 10, 11, 18  
Throttling control 11

## **V**

VSD 3, 5, 9, 10, 11, 12, 14, 15, 17,  
18, 19, 20, 21, 22, 24, 25, 28  
VSD control 3, 9, 10, 11, 12, 15, 18,  
24, 28

## **W**

wall sedimentation 3, 27  
water hammer 19



**ABB Oy**

Drives

P. O. Box 184

FI - 00381 Helsinki

Finland

Telephone +358 10 22 11

Fax +358 10 22 22681

Internet [www.abb.com/motors&drives](http://www.abb.com/motors&drives)