

P&ID SYMBOLS

ISA Symbols and Loop Diagrams

P&IDs

Piping and Instrumentation Diagrams or simply P&IDs are the “schematics” used in the field of instrumentation and control (Automation)

The P&ID is used to by field techs, engineers, and operators to better understand the process and how the instrumentation is inter connected.

Most industries have standardized the symbols according to the ISA Standard S5.1 Instrumentation Symbol Specification.

- Piping & Instrumentation Drawing (original)
- Process & Instrumentation Diagram (also used)
- Process Flow Diagram – PFD (simplified version of the P&ID)

Temperature Process

Using pictorial diagrams may be informative however it is not practical or CAD friendly especially in a multi-loop process.

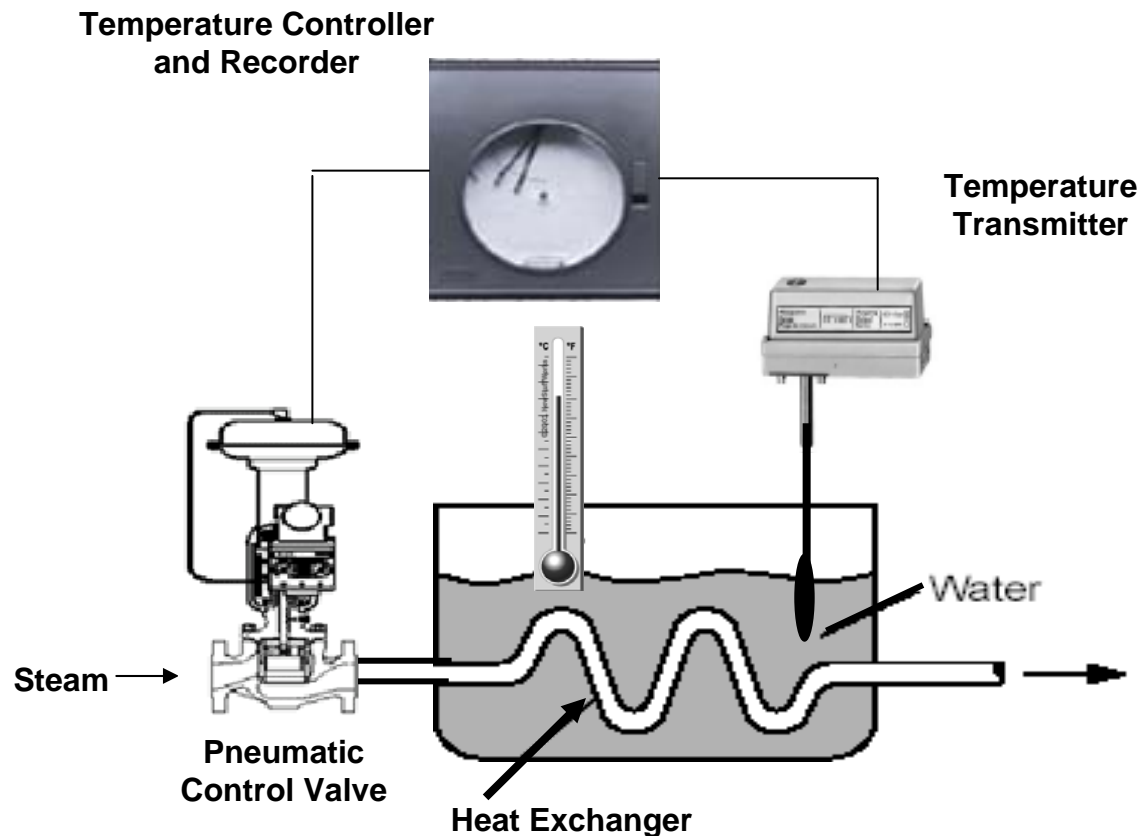

Building the P&ID

The P&ID will use symbols and circles to represent each instrument and how they are inter-connected in the process.

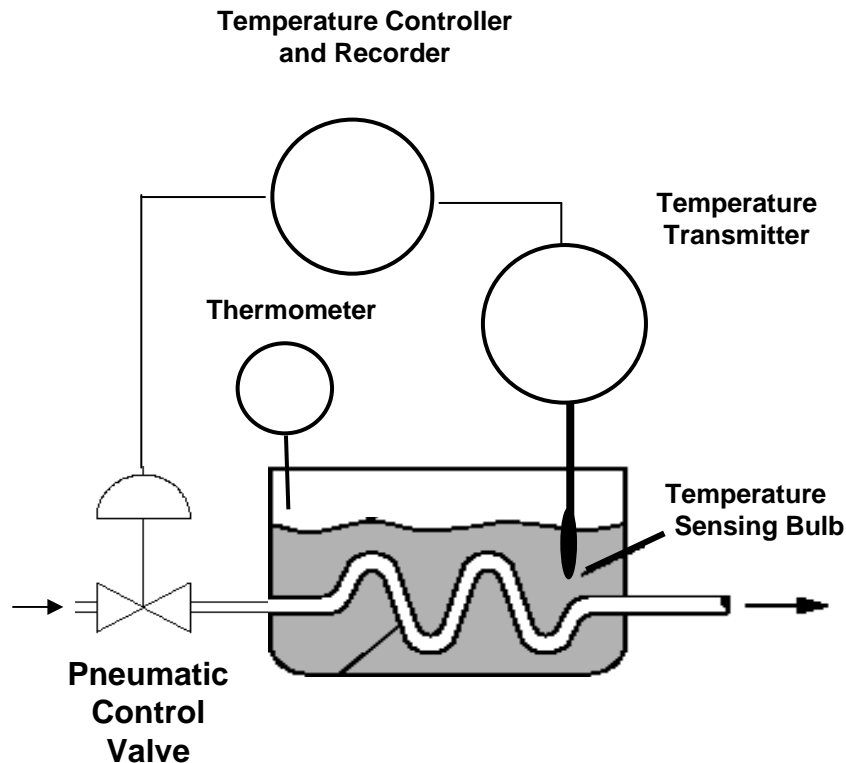



Tag Numbers

Tag “numbers” are letters and numbers placed within or near the instrument to identify the type and function of the device.

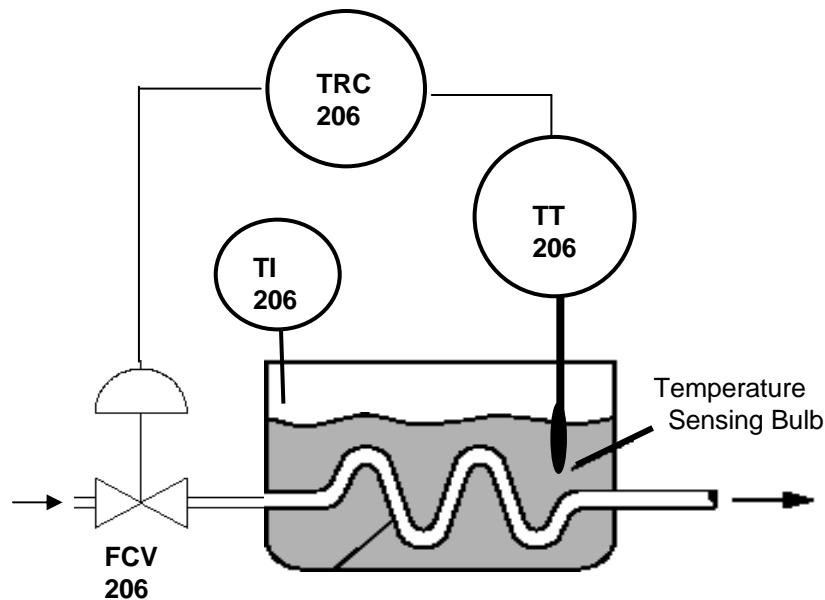

Tag Descriptors

The first letter is used to designate the **measured variable**

The succeeding letter(s) are used to designate the **function** of the component, or to **modify** the meaning of the first letter.

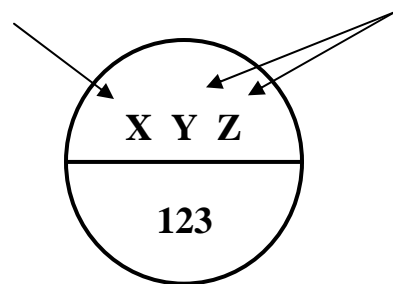

Pressure

Level

Flow

Temperature

Indicator

Recorder

Controller

Transmitter



Tag Numbers

Tag “numbers” are letters and numbers placed within or near the instrument to identify the type and function of the device.

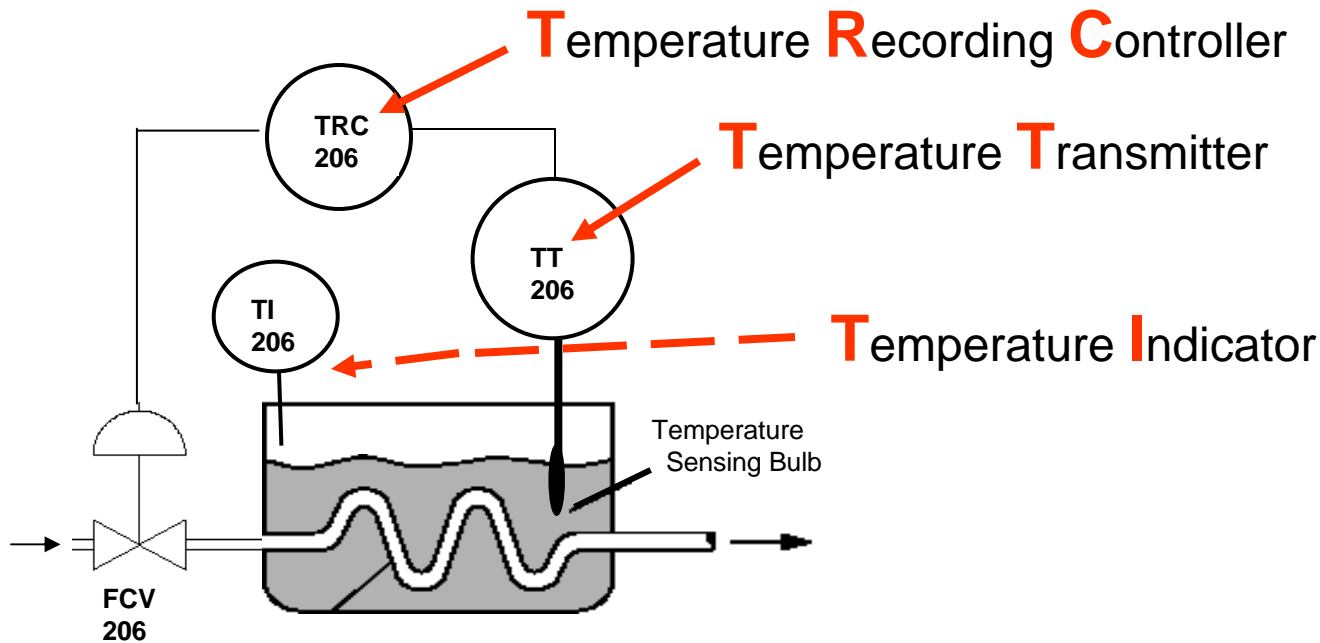

ISA S5.1 Identification Letters

	First-letter		Succeeding- Letters		
	Measured or Initiating variable	Modifier	Readout function	Output function	Modifier
A	Analysis				
C				Control	
D		Differential			
F	Flow Rate	Ratio			
H	Hand				High
I	Current		Indicate		
L	Level				Low
P	Pressure, vacuum				
Q	Quantity	Totalizer			
S		Safety		Switch	
T	Temperature			Transmit	
V	Vibration			Valve, Damper	
z	Position			Actuator	

Examples

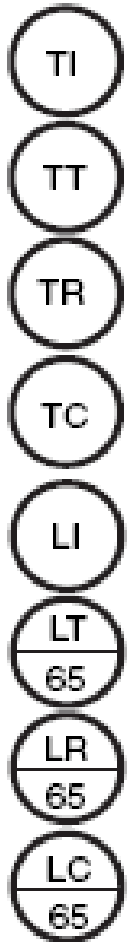

Instrument Location

*The presence or absence of a line determines the location of the physical device. For example **no line** means the instrument is installed in the field near the process.*

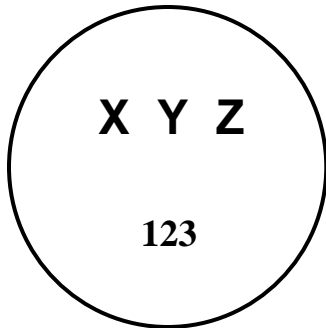

No Line

The instrument is mounted in the field near the process, (close to the operator)

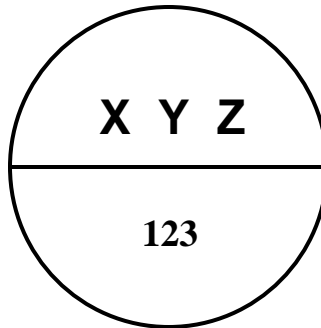

Solid Line

The instrument is mounted in the control room (accessible to the operator)

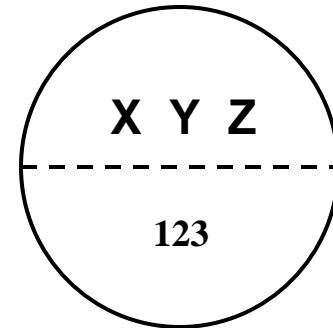

No Line



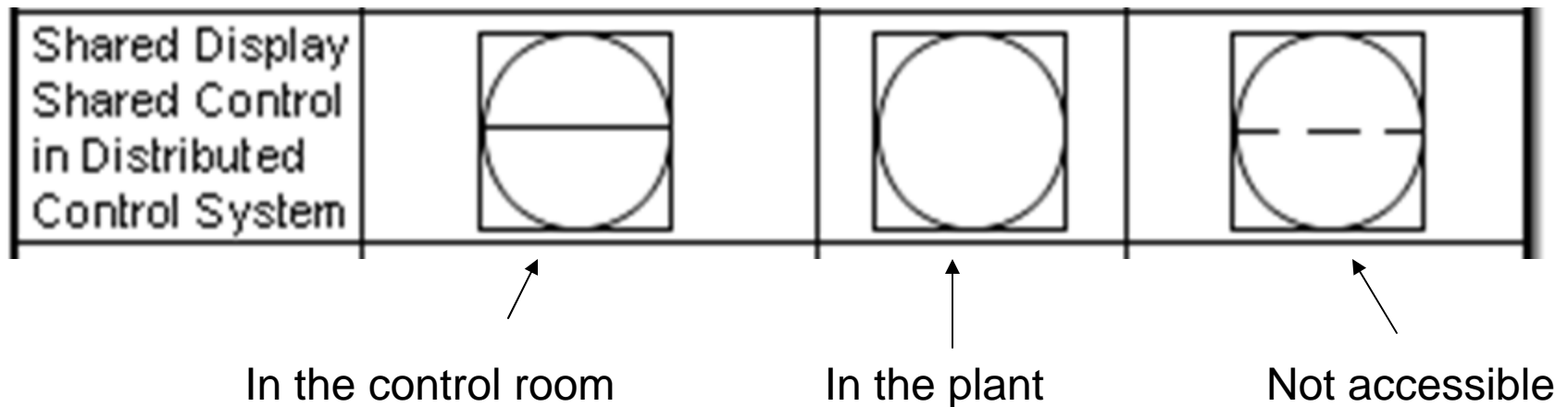

The instrument is mounted out of sight (not accessible to the operator)

Shared Displays/Shared Control

Some instruments are part of a Distributed Control System (DCS) where a specific controller or indicator can be selected from many others but shown in one location (like a terminal screen)

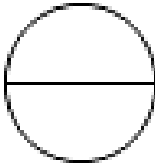

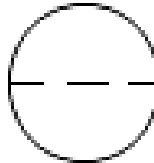
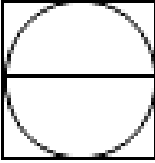
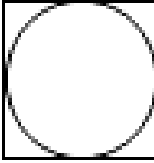
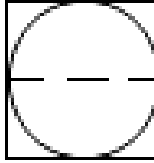
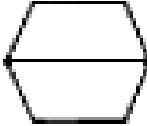
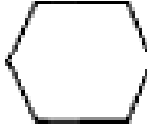
Summary of instrument type & location

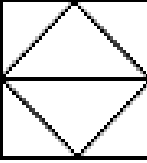
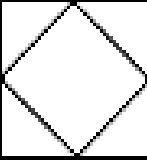
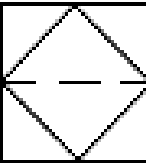
	Accessible to the Operator; Primary Location on the Main Control Panel	Mounted in the Field	Not Normally Accessible to Operator, Behind the Panel
Distinct Elements			
Shared Display Shared Control in Distributed Control System			
Computer Logic Function			
Programmable Logic Control			

Piping and Connection Symbols

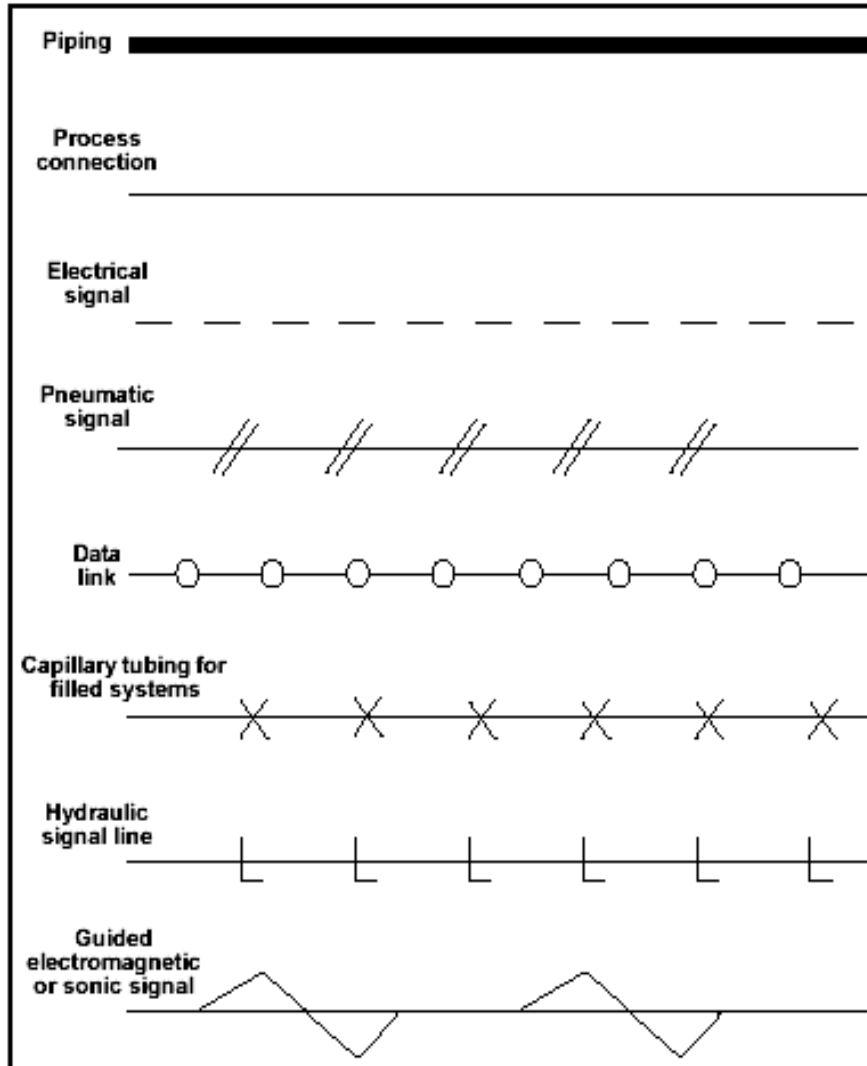

Piping and Connection Symbols

These symbols are used to identify how the instruments in the process connect to each other.

And what type of signal is being used. (electrical, pneumatic, data, etc)

Valve Symbols

Valves



Gate Valve, Hand-operated



Globe Valve, Hand-operated



Plug or Cock Valve, Hand-operated



Check Valve



Butterfly Valve

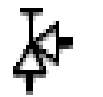

Angle Valve, Hand-operated



Control Valve

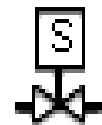

Solenoid Valve

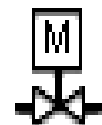

Motor-operated

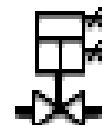

Piston-operated



Safety Valve or
Relief Valve

P&ID Example

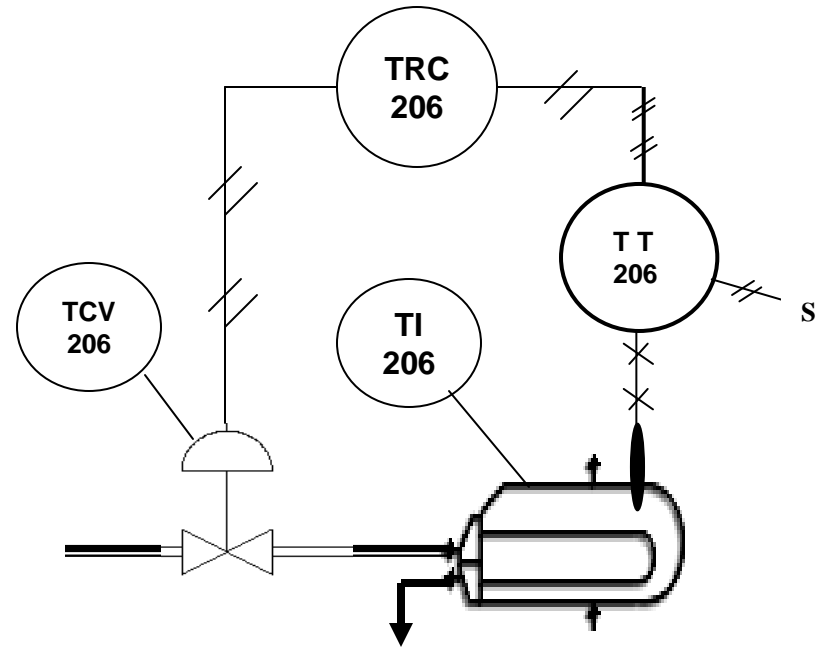
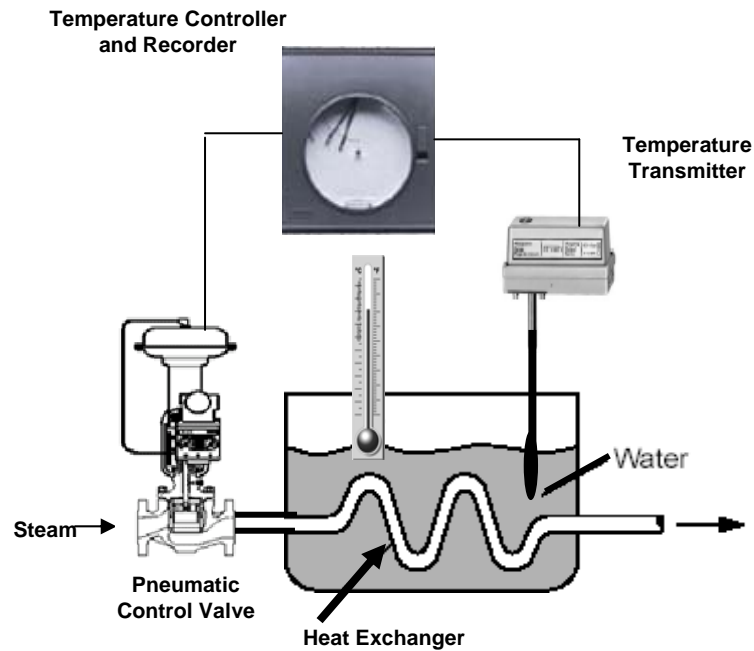

P&ID Exercise

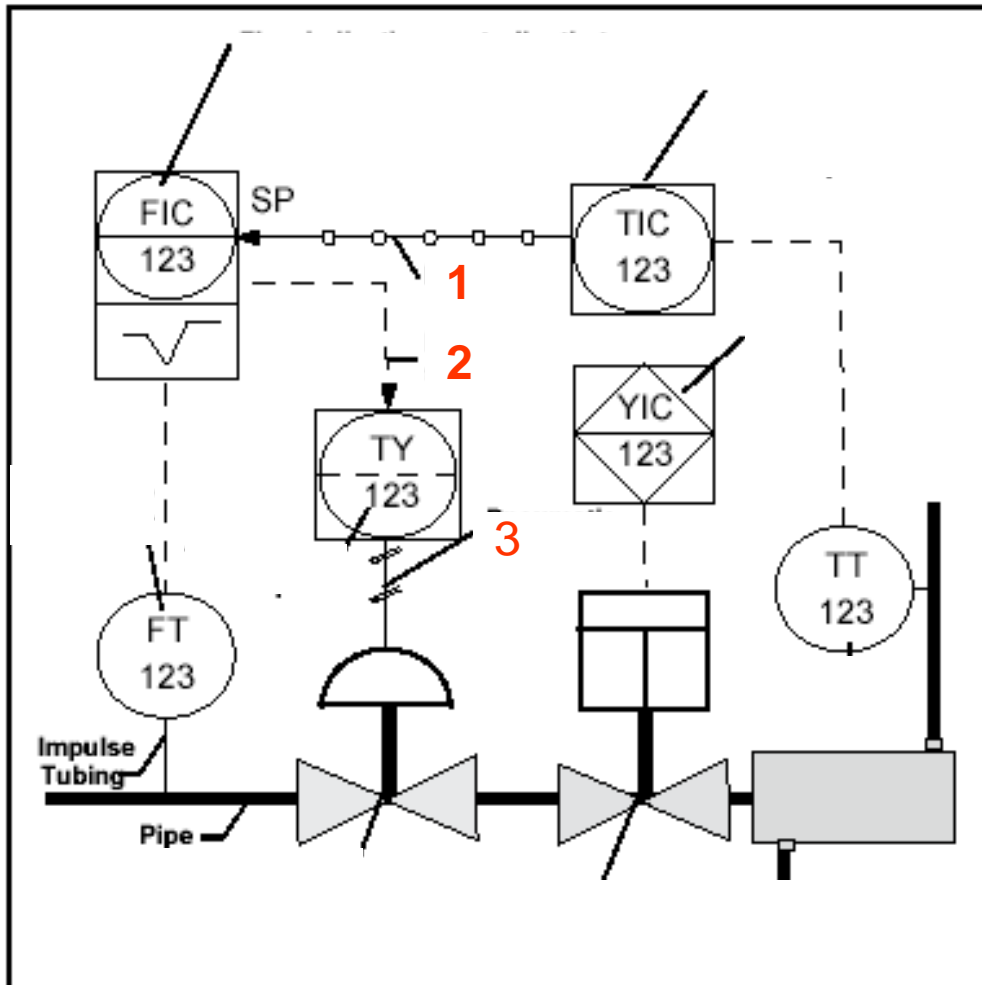

FIC

TIC

YIC

TY

FT

TT

1

2

3

P&ID Exercise

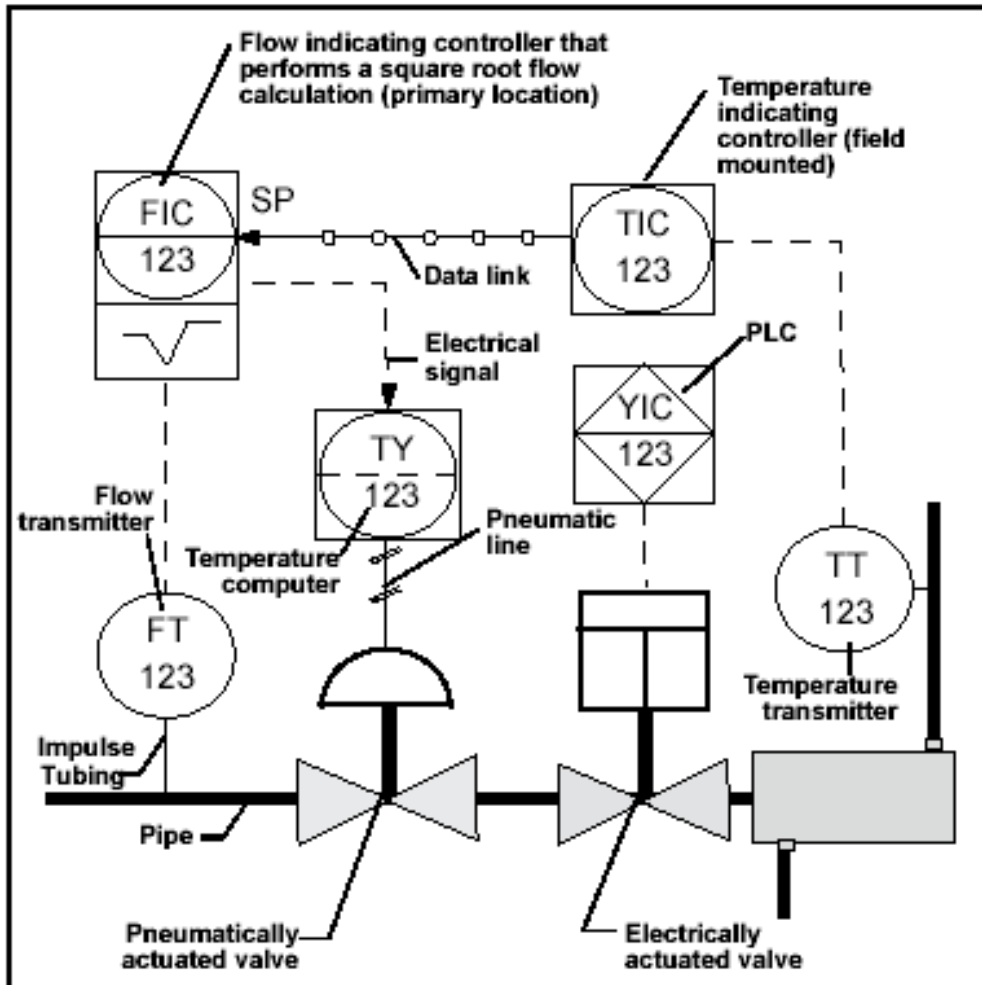

FIC –
Flow Indicating Controller

TIC
Temperature Indicating Cont.

YIC
PLC Indicating Controller

TY
Temperature Computer
Output

FT
Flow Transmitter

TT
Temperature Transmitter

Process Flow Diagram - PFD

A PFD shows less detail than a P&ID and is used only to understand how the process works

