



Fundamentals of UV-visible spectroscopy

Primer



Agilent Technologies

Fundamentals of modern UV-visible spectroscopy

Primer

Tony Owen

© Copyright Agilent Technologies 2000

All rights reserved. Reproduction, adaptation, or translation without prior written permission is prohibited, except as allowed under the copyright laws.

The information contained in this publication is subject to change without notice.

Printed in Germany 06/00
Publication number 5980-1397E

Preface

In 1988 we published a primer entitled “The Diode-Array Advantage in UV/Visible Spectroscopy”. At the time, although diode-array spectrophotometers had been on the market since 1979, their characteristics and their advantages compared with conventional scanning spectrophotometers were not well-understood. We sought to rectify the situation. The primer was very well-received, and many thousands of copies have been distributed.

Much has changed in the years since the first primer, and we felt this was an appropriate time to produce a new primer. Computers are used increasingly to evaluate data; Good Laboratory Practice has grown in importance; and a new generation of diode-array spectrophotometers is characterized by much improved performance. With this primer, our objective is to review all aspects of UV-visible spectroscopy that play a role in obtaining the best results. Microprocessor and/or computer control has taken much of the drudgery out of data processing and has improved productivity. As instrument manufacturers, we would like to believe that analytical instruments are now easier to operate. Despite these advances, a good knowledge of the basics of UV-visible spectroscopy, of the instrumental limitations, and of the pitfalls of sample handling and sample chemistry remains essential for good results.

With this primer, we also want to show that the conventional “single measurement at a single wavelength” approach to obtaining results is insufficient for assuring optimum results. Multiple measurements at multiple wavelengths or (preferably) full spectra yield the best accuracy and precision of results and provide the information necessary to detect erroneous results.

I would like to take this opportunity to thank my colleagues, too numerous to mention by name, at Agilent Technologies from whom I have learned so much about UV-visible spectroscopy over the years.

Contents

Chapter 1 Principles and applications of UV-visible spectroscopy

| | |
|---|----|
| Basic principles..... | 2 |
| The electromagnetic spectrum..... | 2 |
| Wavelength and frequency..... | 3 |
| Origin of UV-visible spectra..... | 3 |
| Transmittance and absorbance..... | 6 |
| Derivative spectra..... | 6 |
| Obtaining derivative spectra..... | 8 |
| Applications..... | 9 |
| Signal-to-noise..... | 9 |
| Instrumental considerations..... | 10 |
| Qualitative analysis..... | 10 |
| Identification—spectra and structure..... | 10 |
| Confirmation of identity..... | 11 |
| Color..... | 13 |
| Other qualitative information..... | 14 |
| Protein and nucleic acid melting temperature..... | 14 |
| Enzyme activity..... | 15 |
| Instrumental considerations..... | 16 |
| Quantitative analysis..... | 16 |
| Beer's law..... | 16 |
| Sample requirements..... | 20 |
| Multicomponent analysis..... | 21 |
| Principle of additivity..... | 21 |
| Simple simultaneous equations method..... | 21 |
| Least squares method..... | 24 |
| Other methods..... | 26 |
| Sample requirements..... | 26 |
| Instrumental requirements..... | 27 |
| Indirect quantification..... | 27 |
| Chemical derivatization..... | 27 |
| Spectrophotometric titrations..... | 28 |
| Enzyme kinetic assays..... | 28 |

Chapter 2 Instrumentation

| | |
|--------------------------|----|
| Instrumental design..... | 30 |
| Components..... | 30 |
| Sources..... | 31 |
| Dispersion devices..... | 32 |

| | |
|--|----|
| Detectors | 33 |
| Optics | 36 |
| The conventional spectrophotometer | 36 |
| The diode array spectrophotometer | 37 |
| Configuration..... | 39 |
| Single-beam design..... | 39 |
| Dual-beam design | 40 |
| Split-beam design | 42 |
| Dual-wavelength design..... | 43 |
| Measuring a spectrum | 43 |
| Key instrumental parameters..... | 44 |
| Spectral resolution..... | 44 |
| Wavelength accuracy and precision | 47 |
| Photometric accuracy and precision..... | 49 |
| Stray light..... | 49 |
| Noise | 50 |
| Linear dynamic range | 51 |
| Drift..... | 52 |

Chapter 3 Sample handling and measurement

| | |
|--|----|
| Liquid samples | 56 |
| Cells | 56 |
| Material | 56 |
| Cell types | 57 |
| Sources of error | 58 |
| Care of cells..... | 59 |
| Choice of solvent..... | 59 |
| Effect of solvent, concentration, pH, and temperature..... | 60 |
| Solid samples | 62 |
| No reference | 62 |
| Refractive index | 63 |
| Sample geometry..... | 63 |
| Weak absorbance..... | 64 |
| Changing slit width | 64 |
| Time averaging | 65 |
| Wavelength averaging..... | 65 |
| Strong absorbance..... | 66 |
| Interference | 67 |
| Types of interference | 67 |
| Other absorbing compounds..... | 68 |
| Scattering..... | 68 |
| Correction techniques | 69 |
| Isoabsorbance | 70 |
| Multicomponent analysis..... | 70 |

| | |
|------------------------------|----|
| Background modeling..... | 71 |
| Internal referencing..... | 72 |
| Three-point correction..... | 72 |
| Derivative spectroscopy..... | 73 |
| Photochemical problems..... | 77 |
| Fluorescence..... | 77 |
| Sample decomposition..... | 78 |

Chapter 4 Method development and validation

| | |
|--------------------------------|----|
| Method development..... | 80 |
| Linearity..... | 81 |
| Accuracy..... | 85 |
| Precision..... | 86 |
| Sensitivity..... | 87 |
| Range..... | 89 |
| Selectivity..... | 89 |
| Ruggedness..... | 91 |
| Instrumental requirements..... | 92 |
| Method validation..... | 92 |

Chapter 5 Routine operation

| | |
|--|-----|
| Instrument performance verification..... | 94 |
| Test parameters..... | 94 |
| Wavelength accuracy and precision..... | 95 |
| Photometric accuracy and precision..... | 96 |
| Stray light..... | 96 |
| Resolution..... | 97 |
| Noise..... | 97 |
| Baseline flatness..... | 98 |
| Stability..... | 98 |
| Linearity..... | 98 |
| Standards..... | 99 |
| Emission standards..... | 99 |
| Solid absorption standards..... | 99 |
| Liquid absorption standards..... | 100 |
| Regulatory requirements..... | 102 |
| GLP/GMP..... | 102 |
| European Pharmacopoeia..... | 102 |
| United States Pharmacopoeia..... | 104 |
| American Standard Testing Methods..... | 105 |
| Recommendations..... | 107 |
| Instrument self-test..... | 112 |

| | |
|------------------------------------|-----|
| System suitability | 113 |
| Proper operation..... | 113 |
| Electronic storage..... | 114 |
| Standard operating procedures..... | 114 |
| Collateral data..... | 114 |
| Confirmation wavelengths..... | 115 |
| Full spectra..... | 115 |
| Statistics..... | 117 |

Appendix A Accuracy and precision

| | |
|---------------------------|-----|
| Definition of terms | 120 |
|---------------------------|-----|

Appendix B Characteristics of diode array spectrophotometers

| | |
|---|-----|
| Advantages of diode array spectroscopy | 122 |
| Fast spectral acquisition | 122 |
| Simultaneous multiwavelength measurement | 123 |
| Wavelength resettability..... | 124 |
| Sensitivity..... | 125 |
| Measurement statistics..... | 125 |
| Ruggedness and reliability..... | 125 |
| Open sample area..... | 126 |
| Disadvantages of diode array spectroscopy | 126 |
| Resolution | 126 |
| Stray light..... | 127 |
| Sample decomposition..... | 127 |
| Complexity..... | 128 |
| Errors in measuring fluorescent samples..... | 128 |

| | |
|------------------------|------------|
| References..... | 129 |
|------------------------|------------|

| | |
|-------------------|------------|
| Index..... | 133 |
|-------------------|------------|

chapter 1

Principles and
applications of
UV-visible
spectroscopy

This chapter outlines the basic theories and principles of UV-visible spectroscopy. These provide valuable insight into the uses and limitations of this technique for chemical analysis. The primary applications of UV-visible spectroscopy are also briefly reviewed.

Basic principles

The electromagnetic spectrum

Ultraviolet (UV) and visible radiation comprise only a small part of the electromagnetic spectrum, which includes such other forms of radiation as radio, infrared (IR), cosmic, and X rays (see Figure 1).

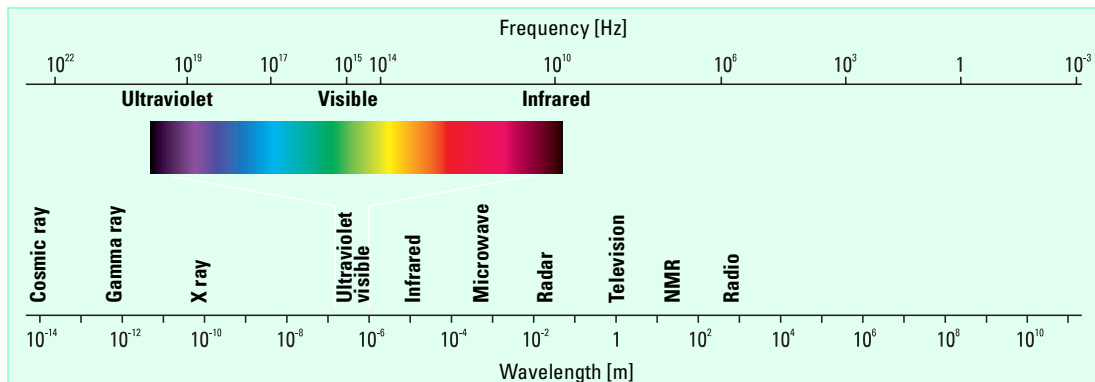

Figure 1
The electromagnetic spectrum

The energy associated with electromagnetic radiation is defined by the following equation:

$$E = h\nu$$

where E is energy (in joules), h is Planck's constant (6.62×10^{-34} Js), and ν is frequency (in seconds).

Wavelength and frequency

Electromagnetic radiation can be considered a combination of alternating electric and magnetic fields that travel through space with a wave motion. Because radiation acts as a wave, it can be classified in terms of either wavelength or frequency, which are related by the following equation:

$$\nu = c/\lambda$$

where ν is frequency (in seconds), c is the speed of light (3×10^8 ms⁻¹), and λ is wavelength (in meters). In UV-visible spectroscopy, wavelength usually is expressed in nanometers (1 nm = 10^{-9} m).

It follows from the above equations that radiation with shorter wavelength has higher energy. In UV-visible spectroscopy, the low-wavelength UV light has the highest energy. In some cases, this energy is sufficient to cause unwanted photochemical reactions when measuring sample spectra (remember, it is the UV component of light that causes sunburn).

Origin of UV-visible spectra

When radiation interacts with matter, a number of processes can occur, including reflection, scattering, absorbance, fluorescence/phosphorescence (absorption and reemission), and photochemical reaction (absorbance and bond breaking). In general, when measuring UV-visible spectra, we want only absorbance to occur.

Because light is a form of energy, absorption of light by matter causes the energy content of the molecules (or atoms) to increase. The total potential energy of a molecule

generally is represented as the sum of its electronic, vibrational, and rotational energies:

$$E_{\text{total}} = E_{\text{electronic}} + E_{\text{vibrational}} + E_{\text{rotational}}$$

The amount of energy a molecule possesses in each form is not a continuum but a series of discrete levels or states. The differences in energy among the different states are in the order:

$$E_{\text{electronic}} > E_{\text{vibrational}} > E_{\text{rotational}}$$

In some molecules and atoms, photons of UV and visible light have enough energy to cause transitions between the different electronic energy levels. The wavelength of light absorbed is that having the energy required to move an electron from a lower energy level to a higher energy level. Figure 2 shows an example of electronic transitions in formaldehyde and the wavelengths of light that cause them.

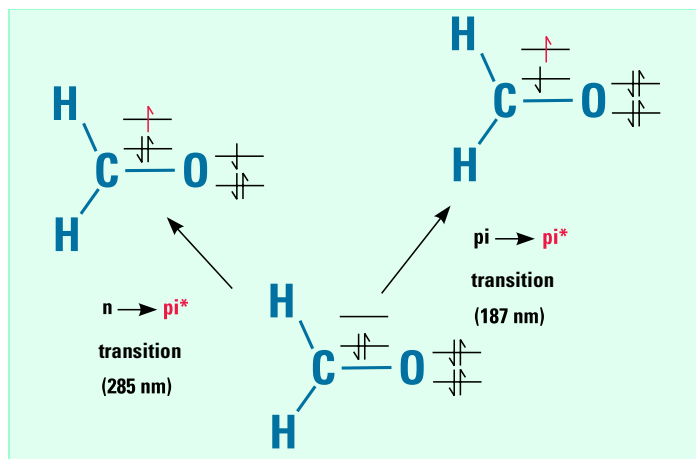

Figure 2
Electronic transitions in formaldehyde

These transitions should result in very narrow absorbance bands at wavelengths highly characteristic of the difference in energy levels of the absorbing species. This is true for atoms, as depicted in Figure 3.

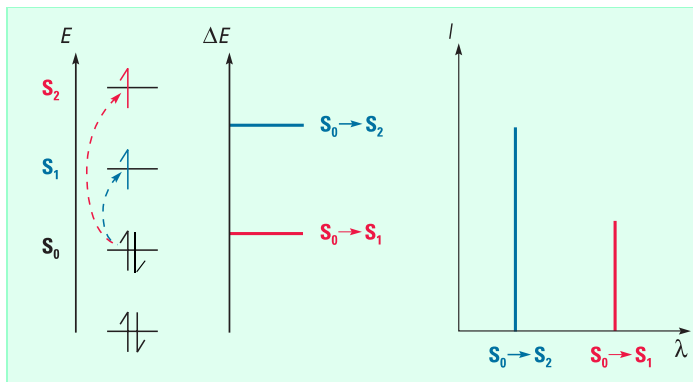

Figure 3
Electronic transitions and spectra of atoms

However, for molecules, vibrational and rotational energy levels are superimposed on the electronic energy levels. Because many transitions with different energies can occur, the bands are broadened (see Figure 4). The broadening is even greater in solutions owing to solvent-solute interactions.

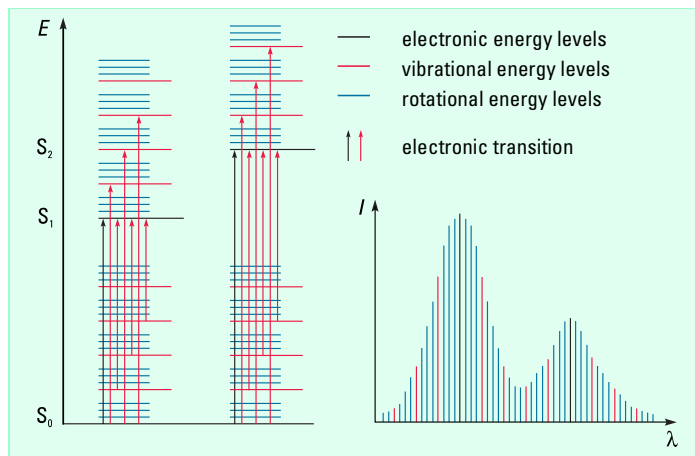

Figure 4
Electronic transitions and UV-visible spectra in molecules

Transmittance and absorbance

When light passes through or is reflected from a sample, the amount of light absorbed is the difference between the incident radiation (I_0) and the transmitted radiation (I). The amount of light absorbed is expressed as either transmittance or absorbance. Transmittance usually is given in terms of a fraction of 1 or as a percentage and is defined as follows:

$$T = I/I_0 \text{ or } \%T = (I/I_0) \times 100$$

Absorbance is defined as follows:

$$A = -\log T$$

For most applications, absorbance values are used since the relationship between absorbance and both concentration and path length normally is linear.

Derivative spectra

If a spectrum is expressed as absorbance (A) as a function of wavelength (λ), the derivative spectra are:

Zero order: $A = f(\lambda)$

First order: $\frac{dA}{d\lambda} = f'(\lambda)$

Second order: $\frac{d^2A}{d\lambda^2} = f''(\lambda)$

Figure 5 on the next page shows the effects of derivatization on a simple Gaussian absorbance band. The derivative spectra are always more complex than the zero-order spectrum.

The first derivative is the rate of change of absorbance against wavelength. It starts and finishes at zero, passing through zero at the same wavelength as λ_{\max} of the absorbance band. This derivative has a positive and a negative band with maximum and minimum at the same wavelengths as the inflection points in the absorbance band. This bipolar function is characteristic of all odd-order derivatives.

The most distinctive feature of the second-order derivative is a negative band with minimum at the same wavelength as the maximum on the zero-order band. This derivative also shows two positive satellite bands on either side of the main band. The fourth derivative shows a positive band with a maximum at the same wavelength as the maximum on the zero order band. Even-order derivatives show a negative or positive band with minimum or maximum at the same wavelength as λ_{\max} on the absorbance band.

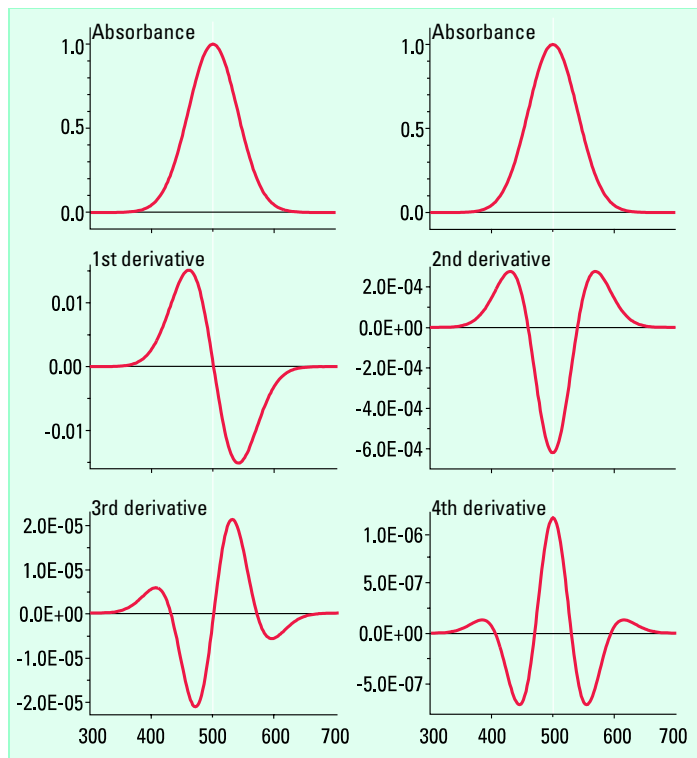

Figure 5
Derivative spectra of a Gaussian absorbance band

Obtaining derivative spectra

Optical, electronic, and mathematical methods all can be used to generate derivative spectra. Although optical and electronic techniques formed the basis of early UV-visible spectroscopy, these have been largely superseded by mathematical methods.

To calculate the derivative at a particular wavelength (λ), a window of $\pm n$ data points is selected, and a polynomial

$$A_{\lambda} = a_0 + a_1\lambda + \dots + a_l\lambda^l$$

is fitted by the least squares method. The coefficients $a_0 \dots a_1$ at each wavelength are the derivative values, where a_1 is the first derivative, a_2 is the second derivative, and so on. Savitzky and Golay developed a highly efficient method to perform the calculations that is the basis of the derivatization algorithm in most commercial instruments. This method also smooths the data. If the polynomial order (l) is less than the number of data points ($2n+1$) in the window, the polynomial generally cannot pass through all data points. Thus the least squares fit gives a smoothed approximation to the original data points.

Although transforming a UV-visible spectrum to its first or a higher derivative usually yields a more complex profile than the zero-order spectrum (see Figure 5), the intrinsic information content is not increased. In fact, it is decreased by the loss of lower-order data such as constant offset factors.

Applications Derivative spectra can be used to enhance differences among spectra, to resolve overlapping bands in qualitative analysis (see “Confirmation of identity” on page 11) and, most importantly, to reduce the effects of interference from scattering, matrix, or other absorbing compounds in quantitative analysis (see “Derivative spectroscopy” on page 73).

Signal-to-noise An unwanted effect of the derivatization process is the decrease in S/N with higher orders of derivatives. This decrease follows from the discrimination effect (see “Derivative spectroscopy” on page 73) and from the fact that noise always contains the sharpest features in the spectrum. Thus, if the spectral data used in the derivative calculation are at 2-nm intervals, the noise has a 2-nm bandwidth. If the analyte band has a bandwidth of 20 nm, the S/N of the first derivative will be 10 times worse than with the zero-order spectrum. The smoothing properties of the Savitzky-Golay polynomial technique can be used to mitigate the decrease in S/N, but care must be taken as too

high a degree of smoothing will distort the derivative spectrum.

Instrumental considerations The higher resolution of derivative spectra places increased demands on the wavelength reproducibility of the spectrophotometer. Small wavelength errors can result in much larger signal errors in the derivative mode than in the absorbance mode.

The negative effect of derivatization on S/N also places increased demands on low-noise characteristics of the spectrophotometer. If the spectrophotometer can scan and average multiple spectra, S/N can be improved further prior to derivatization.

Qualitative analysis

Identification—spectra and structure UV-visible spectra generally show only a few broad absorbance bands. Compared with techniques such as infrared spectroscopy, which produces many narrow bands, UV-visible spectroscopy provides a limited amount of qualitative information. Most absorption by organic compounds results from the presence of π (that is, unsaturated) bonds. A chromophore is a molecular group usually containing a π bond. When inserted into a saturated hydrocarbon (which exhibits no UV-visible absorbance spectrum), it produces a compound with absorption between 185 and 1000 nm. Table 1 lists some chromophores and the wavelengths of their absorbance maxima.

Table 1 Selected chromophores and their absorbance maxima

| Chromophore | Formula | Example | λ_{max} (nm) |
|---------------------|-------------------------------|--------------|-----------------------------|
| Carbonyl (ketone) | $\text{RR}'\text{C}=\text{O}$ | Acetone | 271 |
| Carbonyl (aldehyde) | $\text{RHC}=\text{O}$ | Acetaldehyde | 293 |

Table 1 Selected chromophores and their absorbance maxima

| | | | |
|-----------|--------------------|--------------|-------|
| Carboxyl | RCOOH | Acetic acid | 204 |
| Amide | RCONH ₂ | Acetamide | 208 |
| Ethylene | RCH=CHR | Ethylene | 193 |
| Acetylene | RC=CR | Acetylene | 173 |
| Nitrile | RC=N | Acetonitrile | < 160 |
| Nitro | RNO ₂ | Nitromethane | 271 |

The presence of an absorbance band at a particular wavelength often is a good indicator of the presence of a chromophore. However, the position of the absorbance maximum is not fixed but depends partially on the molecular environment of the chromophore and on the solvent in which the sample may be dissolved. Other parameters, such as pH and temperature, also may cause changes in both the intensity and the wavelength of the absorbance maxima.

Conjugating the double bond with additional double bonds increases both the intensity and the wavelength of the absorption band. For some molecular systems, such as conjugated hydrocarbons or carotenoids, the relationship between intensity and wavelength has been systematically investigated.

Transition metal ions also have electronic energy levels that cause absorption of 400–700 nm in the visible region.

Confirmation of identity

Although UV-visible spectra do not enable absolute identification of an unknown, they frequently are used to confirm the identity of a substance through comparison of the measured spectrum with a reference spectrum.

Where spectra are highly similar, derivative spectra may be used. As shown in Figure 6, the number of bands increases with higher orders of derivatives. This increase in

complexity of the derivative spectra can be useful in qualitative analysis, either for characterizing materials or for identification purposes. For example, the absorbance spectrum of the steroid testosterone shows a single, broad, featureless band centered at around 330 nm, whereas the second derivative shows six distinct peaks.

The resolution enhancement effect may be of use as well in identifying an unknown. Figure 6 shows a computer simulation. When two Gaussian bands with a 40-nm natural spectral bandwidth (NBW) separated by 30 nm are added in absorbance mode, a single band with a maximum midway between the two component bands results. The two components are not resolved. In the fourth derivative, these two bands are clearly visible, with maxima centered close to the λ_{max} of the component bands.

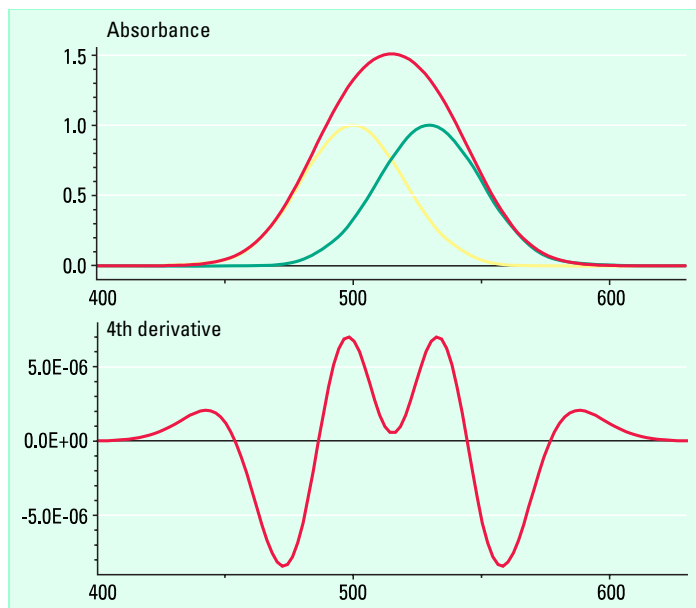

Figure 6
Resolution enhancement

Color Color is an important property of a substance. The color of matter is related to its absorptivity or reflectivity. The human eye sees the complementary color to that which is absorbed, as shown in Figure 7 and Figure 8.

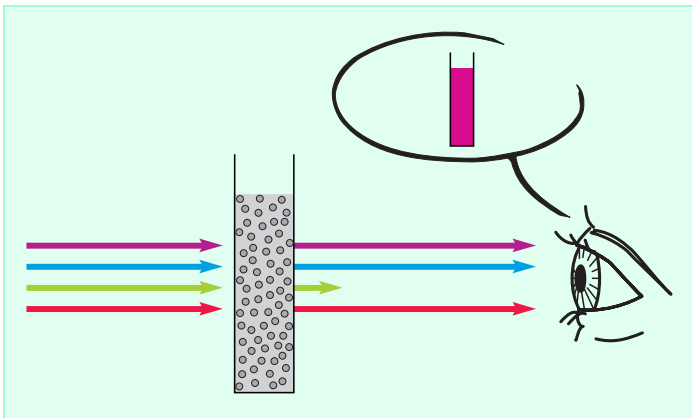

Figure 7
Transmission and color

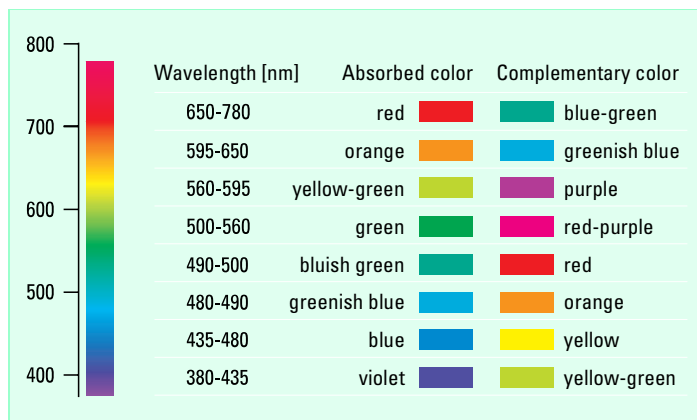

Figure 8
Absorbance and complementary colors

In practice, both the generation and sensation of color are highly complex and depend on many factors, including the spectrum of the illuminant and, in the case of solids, the surface structure. Specialized color measurement systems, such as the CIE L*a*b, and instrumentation to measure color have been developed. When equipped with the appropriate software, most spectrophotometers can be used to measure color. An in-depth discussion of color is beyond the scope of this primer. Several well-written publications^{2,3} discuss color and the measurement of color in detail.

Other qualitative information

UV-visible spectroscopy can be used to determine many physicochemical characteristics of compounds and thus can provide information as to the identity of a particular compound. Two examples follow.

Protein and nucleic acid melting temperature

The absorbance spectra of proteins result largely from the presence of the aromatic amino acids tryptophan, tyrosine, and phenylalanine. A protein at room temperature has a specific tertiary structure or conformation that in turn creates a specific electronic environment for the aromatic amino acids. If the protein is heated it will, at a certain temperature, unfold or melt and lose its structure. In this process, the electronic environment of the aromatic amino acids changes, which in turn results in spectral changes or shifts.

Multicomponent analysis (see “Multicomponent analysis” on page 21) can be used to determine how many of each aromatic amino acid are present in an intact protein.⁴

Deoxyribonucleic acid (DNA) in its native state comprises two strands of deoxyribose molecules helically wound around the same axis. The strands are linked by hydrogen bonds between the purine and pyrimidine bases—adenine is joined to thymine (A-T), and guanine to cytosine (G-C). These bases are primarily responsible for the UV absorbance of DNA, with a peak maximum at 260 nm. As in

any multicomponent system, the observed absorption of any DNA molecule should equal the sum of the individual absorbances:

$$A_{\text{DNA}} = A_{\text{adenine}} + A_{\text{guanine}} + A_{\text{cytosine}} + A_{\text{thymine}}$$

However, the observed absorbance is always significantly less than expected because the hydrogen bonding between the bases changes their electronic environment. When a molecule is heated, the hydrogen bonds break, the double helix unwinds, and the absorbance increases so that it approaches that expected from the sum of all bases. This denaturation process also is known as melting. In a DNA melt experiment, the temperature of a DNA solution is increased in a stepwise fashion, and the absorbance at 260 nm at each temperature is measured and plotted as a melting curve.

The midpoint of the temperature range over which the melting occurs is the T_m value. The T_m value of a particular DNA sample depends primarily on the percentage of G-C pairs in the sample, each of which contains three hydrogen bonds (in contrast, each A-T pair contains two hydrogen bonds). The higher the percentage of G-C pairs in the sample, the higher the observed T_m .

Enzyme activity The activity of an enzyme is a measure of its effectiveness as a catalyst. The concentration of enzyme in an impure preparation can be expressed in terms of units per milliliter, and the specific activity of the preparation can be expressed as units per milligram of protein. As an enzyme is purified, the specific activity increases to a limit (that of the pure enzyme).

Because reaction rate varies with such factors as substrate concentration, pH, ionic strength, and temperature, the conditions under which the activity is determined must be defined precisely. These conditions are usually the optimal assay conditions at a fixed temperature (25, 30, or 37 °C),

with all substrates present at saturating conditions. To determine activity, a system is set up with known concentrations of substrate and, if necessary, coenzyme. A known weight of the enzyme is added and the rate of reaction determined. Activity measurements are conducted primarily in the research environment as enzymes are isolated and purified, and in the manufacture of enzyme assay kits, in which the enzyme activity must be consistent from batch to batch.

Instrumental considerations

Absolute wavelength accuracy and absolute photometric accuracy are very important in qualitative analysis, particularly for the identification and confirmation of unknowns. Often spectra acquired on different instruments at different times are compared. In this regard, spectra may have to be measured at a defined instrumental resolution.

Quantitative analysis

Beer's law

If 100 photons of light enter a cell and only 50 emerge from the other side, the transmittance is 0.5, or 50 %. If these 50 photons then pass through an identical cell, only 25 will emerge, and so forth. Figure 9 shows the plot of transmittance against path length.

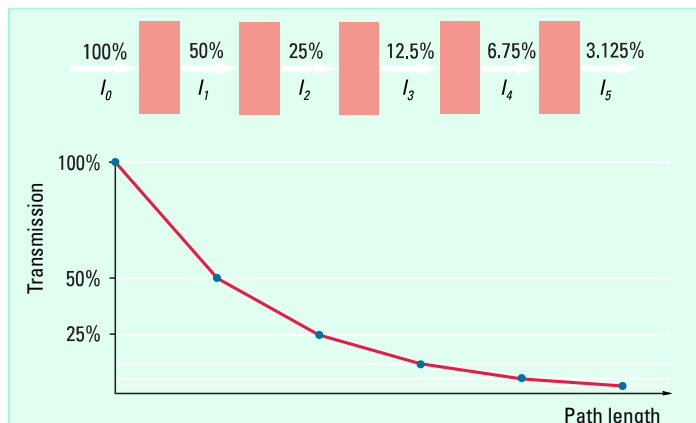

Figure 9
Transmittance and path length—the Bouguer-Lambert law

Lambert (1760) generally is credited with the first mathematical formulation of this effect, although it now appears that Bouguer first stated it in 1729. The mathematical expression is:

$$T = I/I_0 = e^{-kb}$$

where I_0 is the incident intensity, I is the transmitted intensity, e is the base of natural logarithms, k is a constant, and b is the path length (usually in centimeters).

Beer's law is identical to Bouguer's law, except that it is stated in terms of concentration. The amount of light absorbed is proportional to the number of absorbing molecules through which the light passes. Figure 10 shows a plot of transmittance against concentration.

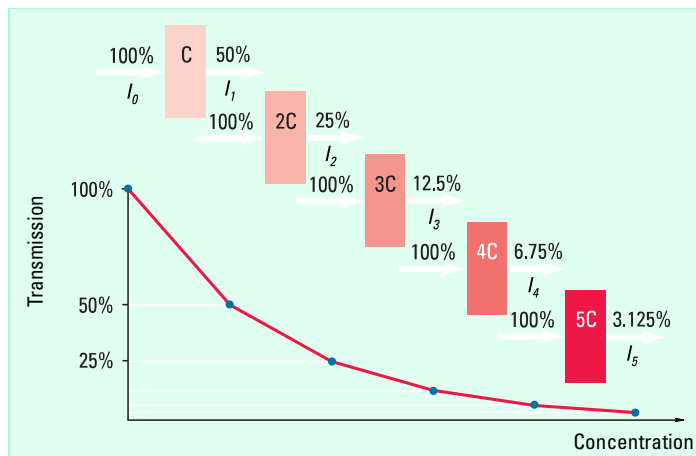

Figure 10
Transmittance and concentration—Beer's law

Combining the two laws gives the Beer-Bouguer-Lambert law:

$$T = I/I_0 = e^{-kbc}$$

where c is the concentration of the absorbing species (usually expressed in grams per liter or milligrams per liter). This equation can be transformed into a linear expression by taking the logarithm and is usually expressed in the decadic form:

$$A = -\log T = -\log(I/I_0) = \log(I_0/I) = \epsilon bc$$

where ϵ is the molar absorption or extinction coefficient. This expression is commonly known as Beer's law. Figure 11 shows a plot of absorbance against concentration.

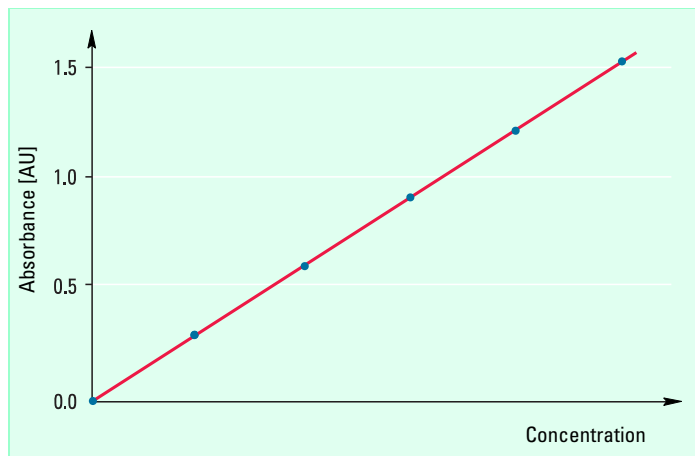

Figure 11
The Beer-Bouguer-Lambert law

The extinction coefficient (ϵ) is characteristic of a given substance under a precisely defined set of conditions, such as wavelength, solvent, and temperature. In practice, the measured extinction coefficient also depends partially on the characteristics of the instrument used. For these reasons, predetermined values for the extinction coefficient usually are not used for quantitative analysis. Instead, a calibration or working curve for the substance to be analyzed is constructed using one or more standard solutions with known concentrations of the analyte.

For electronic transitions, the difference in energy between ground and excited states is relatively large. Therefore, at room temperature, it is highly likely that all molecules are in the electronic ground state. Absorption and return to ground state are fast processes, and equilibrium is reached very quickly. Thus, absorption of UV-visible light is quantitatively highly accurate. The simple linear relationship between absorbance and concentration and the relative ease of measurement of UV-visible light have made

UV-visible spectroscopy the basis for thousands of quantitative analytical methods.

Assuming Beer's law is obeyed for the zero-order spectrum, a similar linear relationship exists between concentration and amplitude for all orders of derivative spectra:

Zero order: $A = \epsilon bc$

First derivative: $\frac{dA}{d\lambda} = \frac{d\epsilon}{d\lambda} bc$

nth derivative: $\frac{d^n A}{d\lambda^n} = \frac{d^n \epsilon}{d\lambda^n} bc$

at λ , where A is absorbance, ϵ is the extinction coefficient, b is the sample path length, and c is the sample concentration.

For single-component quantification, the selection of wavelengths is more difficult with derivative spectra than with absorbance spectra since both positive and negative peaks are present. The even-order derivatives have a peak maximum or minimum at the same λ_{\max} as the absorbance spectrum, but for the odd-order derivatives, this wavelength is a zero-crossing point. Taking the difference between the highest maximum and the lowest minimum gives the best S/N but may result in increased sensitivity to interference from other components.

Sample requirements

For accurate results, the sample to be analyzed must contain only the absorbing component for which the calibration has been performed. If the sample is a solution, a pure sample of the solvent should be used as a blank. It may be possible to correct for an interfering component with a second wavelength.

Multicomponent analysis

Multicomponent analyses using UV-visible spectra have been performed for almost as long as single-component analyses, but because the techniques used in multicomponent analysis often gave incorrect results (as detailed below), they were not widely applied. However, modern instruments yield more precise data, and modern curve-fitting techniques give more accurate results and—perhaps more importantly—indicate when results are incorrect. For these reasons, multicomponent UV-visible analyses are becoming more popular.

Principle of additivity

According to Beer's law (see "Beer's law" on page 16), absorbance is proportional to the number of molecules that absorb radiation at the specified wavelength. This principle is true if more than one absorbing species is present. All multicomponent quantitative methods are based on the principle that the absorbance at any wavelength of a mixture is equal to the sum of the absorbance of each component in the mixture at that wavelength.

Simple simultaneous equations method

The simple approach to multicomponent analysis is based on measurements at a number of wavelengths equal to the number of components in the mixture. The wavelengths chosen usually are those of the absorbance maximum of each component. For calibration, the absorbance of standards of known concentrations of pure components is measured to determine the extinction coefficient for each component at each wavelength selected.

The absorbance of the mixture at each wavelength is the sum of the absorbance of each component at that wavelength, which in turn depends on the extinction coefficient and the concentration of each component. Thus for two components x and y , the equations are:

$$A'_{(x+y)} = A'_x + A'_y = e'_x b c_x + e'_y b c_y$$

and

$$A''_{(x+y)} = A''_x + A''_y = e''_x bc_x + e''_y bc_y$$

where A' is absorbance at wavelength ' λ ', A'' is absorbance at wavelength ' λ ', e' is molar absorptivity at wavelength ' λ ', e'' is molar absorptivity at wavelength ' λ ', c is concentration, and b is path length.

These equations are easily solved to determine the concentration of each component. If measurements were always perfect, accurate results could be obtained even for complex mixtures of components with very similar spectra. In practice, however, measurement errors always occur. Such errors can affect significantly the accuracy of results when spectra overlap significantly. Figure 12 shows a simulated two-component mixture with no overlap of the spectra at the absorbance maxima.

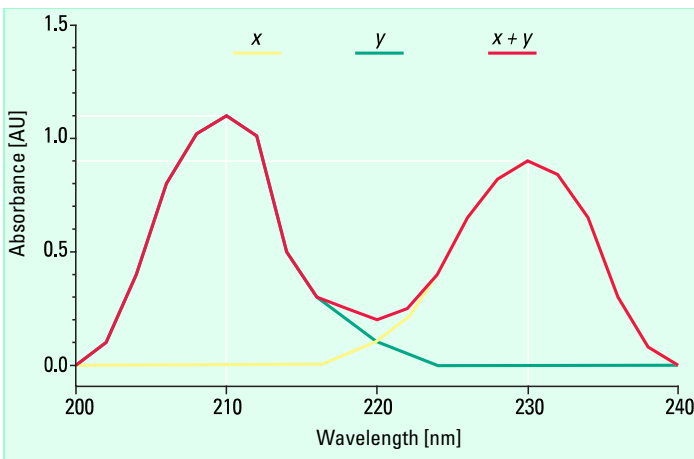

Figure 12
A two-component mixture with little spectral overlap

In contrast, Figure 13 shows a simulated two-component mixture with significant overlap of the spectra at the absorbance maxima.

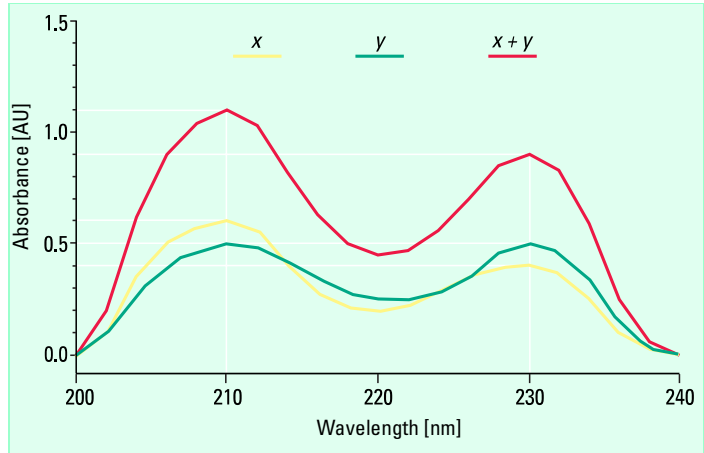

Figure 13
A two-component mixture with significant spectral overlap

For a mixture of x and y where $cx = cy = 1$, the measured absorbances should be:

| With little spectral overlap | With substantial spectral overlap |
|--------------------------------|-----------------------------------|
| $A_{(x+y)} = 1.1 + 0.0 = 1.1$ | $A_{(x+y)} = 0.6 + 0.5 = 1.1$ |
| $A'_{(x+y)} = 0.0 + 0.9 = 0.9$ | $A'_{(x+y)} = 0.4 + 0.5 = 0.9$ |

If a 10 % error occurs in the measurement of $A'_{(x+y)}$ and $A''_{(x+y)}$, that is, $A'_{(x+y)} = 0.99$ (- 10 %) and $A''_{(x+y)} = 0.99$

(+ 10 %), the quantitative calculation yields the results shown in Table 2:

Table 2 Comparison of multicomponent analysis results for examples with little and substantial spectral overlap

| Component | Nominal concentration | Little spectral overlap | | Substantial spectral overlap | |
|-----------|-----------------------|--------------------------|---------|------------------------------|---------|
| | | Calculated concentration | % error | Calculated concentration | % error |
| x | 1 | 0.9 | - 10 % | 0.0 | - 100 % |
| y | 1 | 1.1 | + 10 % | 1.98 | + 98 % |

Least squares method The effect of random noise can be reduced through the use of additional spectral information, that is, a series of data points can be used for quantification instead of only two. In this so-called overdetermined system, a least squares fit of the standard spectra to the spectrum of the measured sample yields quantitative results.^{5,6} Figure 14 depicts a spectrum for the two-component mixture shown in Figure 13 with a 10 % random error at each measurement point.

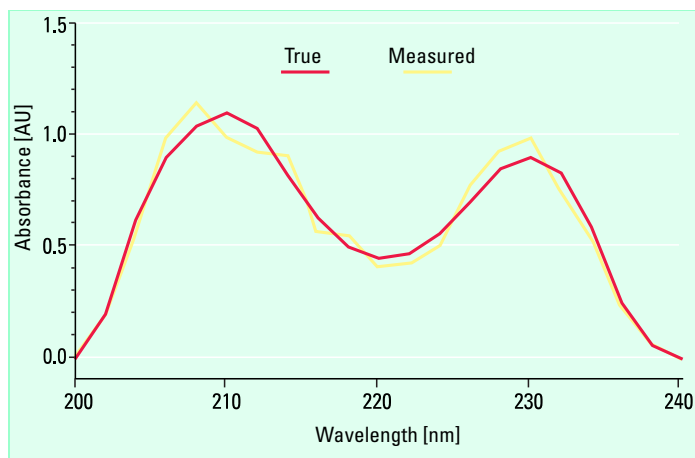

Figure 14
Mixture spectrum with 10 % random error at each wavelength

With 21 data points (2-nm intervals over 200–240 nm), the quantitative results from the least squares method have an error of < 1 % compared with an error of approximately 100 % from the usual measurements at two wavelengths, as shown in Table 3.

Table 3 Comparison of multicomponent analysis results from simple simultaneous equations and least squares methods

| Component | Nominal concentration | Using 210 and 230 nm only | | Using 200–240 nm | |
|-----------|-----------------------|---------------------------|---------|--------------------------|---------|
| | | Calculated concentration | % error | Calculated concentration | % error |
| x | 1 | 0.0 | - 100 % | 1.003 | + 0.3 % |
| y | 1 | 1.98 | + 98 % | 0.995 | - 0.5 % |

This method enables the analysis of more complex mixtures and of simple mixtures of components with similar spectra.

The residual from the least squares calculation is a good indicator of how well the standard spectra fit the sample spectra and is therefore a good indicator of the probable accuracy of the results.

An example of multicomponent analysis is the quantification of five hemoglobins in blood with minimum sample preparation.⁷ Figure 15 shows the absorption spectra of hemoglobin derivatives. This analysis was previously performed using various analytical techniques, including spectroscopy and titrations.

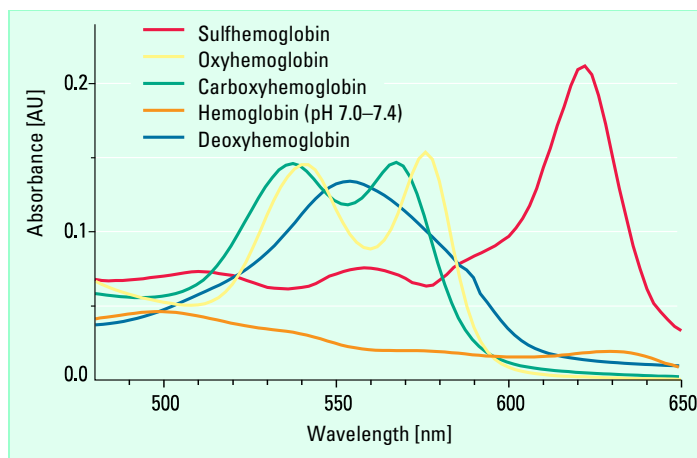

Figure 15
Absorption spectra of hemoglobin derivatives

Other methods Other statistical approaches to multicomponent analysis include the partial least squares (PLS), principle component regression (PCR), and multiple least squares (MLS) methods. In theory, these methods offer some advantages over those described above, but in practice the calibration process is much more complex.

Sample requirements The simple simultaneous equations and least squares methods yield accurate results only if calibration is performed using pure standards or mixtures of standards

for each component in the sample that contributes to the UV spectrum. The unknown sample must not have any additional absorbing capacity.

Instrumental requirements

Single-component quantification is normally performed by measuring with the same instrument a standard or series of standards followed by an unknown. This calibration process should eliminate instrumental bias, making absolute wavelength accuracy and absolute photometric accuracy relatively unimportant. On the other hand, photometric reproducibility is essential for precise results. If measurements are performed only at the absorbance maximum, wavelength reproducibility is also of little importance because the rate of change of absorbance with wavelength is low. However, if a wavelength on the side of the band is used, wavelength reproducibility becomes very important. Finally, the instrumental linear range is critical, as the calibration process relies on a linear relationship.

Accurate multicomponent analyses require excellent S/N, especially if the simple simultaneous equations method is used. In the least squares method, data from the sides of absorbance bands is incorporated into the calculation, making excellent wavelength reproducibility essential as well. Moreover, because more data is required, fast scanning is necessary for productivity.

Indirect quantification

Chemical derivatization

Because many compounds exhibit either very weak or no absorbance in the UV or visible regions, a number of methods using chemical derivatization have been developed. Such methods usually involve adding an organic reagent, which forms a complex with strong absorptivity. The final stage of measurement closely resembles that of

the direct methods. With this technique, the choice of an appropriate reagent can enhance significantly both sensitivity and selectivity.

Spectrophotometric titrations

In volumetric analyses, the color changes that signify the end point of a titration are most often detected through visual inspection. This process is inherently subjective and can be a source of error. The use of a spectrophotometer for endpoint detection introduces objectivity into the analysis and lends itself to automation.

Enzyme kinetic assays

Direct UV-visible analysis of one component in biological matrices, for example blood or foodstuffs, is difficult. Interference from other components often makes impossible direct measurement of a specific property, such as absorbance. Separation of the compound of interest may be costly and time-consuming and thus impracticable for routine analysis.

Enzyme assays can be used in the indirect analysis of one compound or a group of compounds in a complex matrix. If the enzyme is carefully selected, any change in the sample following addition of the enzyme will result only from the reaction of the specific compound or compounds. This selectivity is the basis of enzyme assays.

Enzyme assays can be divided broadly into two types: rate assays and end point assays. The rate of an enzyme depends on many factors, including temperature, pH, enzyme activity, enzyme concentration, and substrate concentration. However, if all other parameters are controlled at a constant level, the rate of reaction is directly proportional to the substrate concentration. With end point assays, the conditions are selected so that the conversion of substrate to product is completed within a reasonable period of time (5–20 min). The difference between initial absorbance and final absorbance is directly proportional to the amount of substrate.

chapter 2

Instrumentation

Ideally, analytical instruments always yield correct measurements of a chemical or physicochemical parameter, but in practice all instruments are subject to error. In this chapter we review the basic components of a spectrophotometer and the various instrument configurations available. Key instrumental parameters and their potential adverse effects on the measured values are also discussed.

Instrumental design

Components A spectrophotometer is an instrument for measuring the transmittance or absorbance of a sample as a function of the wavelength of electromagnetic radiation. The key components of a spectrophotometer are:⁸

- a source that generates a broad band of electromagnetic radiation
- a dispersion device that selects from the broadband radiation of the source a particular wavelength (or, more correctly, a waveband)
- a sample area
- one or more detectors to measure the intensity of radiation

Other optical components, such as lenses or mirrors, relay light through the instrument.

Sources The ideal light source would yield a constant intensity over all wavelengths with low noise and long-term stability. Unfortunately, however, such a source does not exist. Two sources are commonly used in UV-visible spectrophotometers.

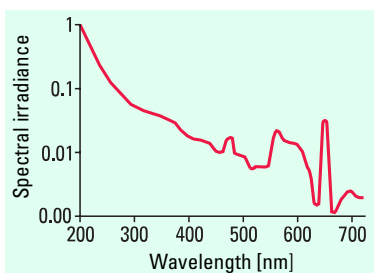

Figure 16
Intensity spectrum of the
deuterium arc lamp

The first source, the deuterium arc lamp, yields a good intensity continuum in the UV region and provides useful intensity in the visible region (see Figure 16). Although modern deuterium arc lamps have low noise, noise from the lamp is often the limiting factor in overall instrument noise performance. Over time, the intensity of light from a deuterium arc lamp decreases steadily. Such a lamp typically has a half-life (the time required for the intensity to fall to half of its initial value) of approximately 1,000 h.

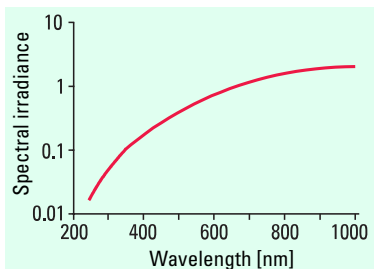

Figure 17
Intensity spectrum of the
tungsten-halogen lamp

The second source, the tungsten-halogen lamp (see Figure 17), yields good intensity over part of the UV spectrum and over the entire visible range. This type of lamp has very low noise and low drift and typically has a useful life of 10,000 h.

Most spectrophotometers used to measure the UV-visible range contain both types of lamps. In such instruments, either a source selector is used to switch between the lamps as appropriate, or the light from the two sources is mixed to yield a single broadband source.

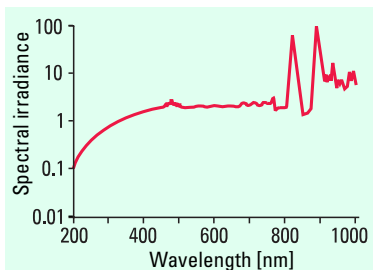

Figure 18
Intensity spectrum of the
xenon lamp

Dispersion devices

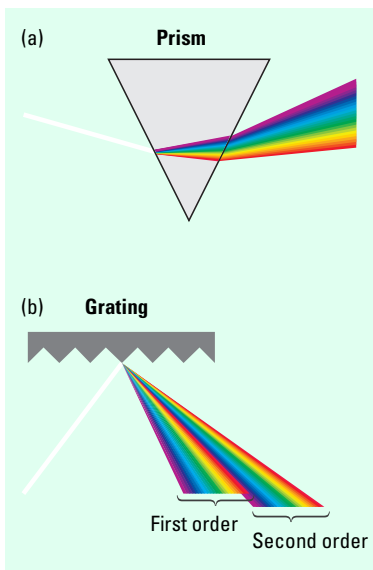

Figure 19
Dispersion devices

An alternate light source is the xenon lamp (see Figure 18), which yields a good continuum over the entire UV and visible regions. However, because the noise from currently available xenon lamps is significantly worse than that from deuterium or tungsten lamps, xenon lamps are used only for applications such as diffuse reflectance measurements, in which high intensity is the primary concern.

Dispersion devices cause different wavelengths of light to be dispersed at different angles. When combined with an appropriate exit slit, these devices can be used to select a particular wavelength (or, more precisely, a narrow waveband) of light from a continuous source. Two types of dispersion devices, prisms and holographic gratings, are commonly used in UV-visible spectrophotometers.

A prism generates a rainbow from sunlight. This same principle is used in spectrophotometers. Prisms are simple and inexpensive, but the resulting dispersion is angularly nonlinear (see Figure 19a). Moreover, the angle of dispersion is temperature sensitive.

For these reasons, most modern spectrophotometers contain holographic gratings instead of prisms. These devices are made from glass blanks, onto which very narrow grooves are ruled. Traditionally, this task was done mechanically, but modern production methods use a holographic optical process. The dimensions of the grooves are of the same order as the wavelength of light to be dispersed. Finally, an aluminum coating is applied to create

a reflecting source. Light falling on the grating is reflected at different angles, depending on the wavelength. Holographic gratings yield a linear angular dispersion with wavelength and are temperature insensitive. However, they reflect light in different orders, which overlap (see Figure 19b). As a result, filters must be used to ensure that only the light from the desired reflection order reaches the detector. A concave grating disperses and focuses light simultaneously.

A monochromator consists of an entrance slit, a dispersion device, and an exit slit. Ideally, the output from a monochromator is monochromatic light. In practice, however, the output is always a band, optimally symmetrical in shape. The width of the band at half its height is the instrumental bandwidth (IBW).

Detectors

A detector converts a light signal into an electrical signal. Ideally, it should give a linear response over a wide range with low noise and high sensitivity. Spectrophotometers normally contain either a photomultiplier tube detector or a photodiode detector.

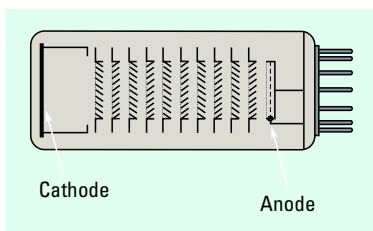

Figure 20
The photomultiplier tube detector

The photomultiplier tube (see Figure 20) combines signal conversion with several stages of amplification within the body of the tube. The nature of the cathode material determines spectral sensitivity. A single photomultiplier yields good sensitivity over the entire UV-visible range. This type of detector yields high sensitivity at low light levels. However, in analytical spectroscopy applications, high sensitivity is associated with low concentrations, which result in low absorbances, which in turn result in high intensity levels. To detect accurately small differences between blank and sample measurements, the detector must have low noise at high intensity levels.

Increasingly, photodiodes are used as detectors in spectrophotometers (see Figure 21). Photodiode detectors have a wider dynamic range and, as solid-state devices, are more robust than photomultiplier tube detectors. In a

photodiode, light falling on the semiconductor material allows electrons to flow through it, thereby depleting the charge in a capacitor connected across the material. The amount of charge needed to recharge the capacitor at regular intervals is proportional to the intensity of the light. Earlier photodiodes had low sensitivity in the low UV range, but this problem has been corrected in modern detectors. The limits of detection are approximately 170–1100 nm for silicon-based detectors.

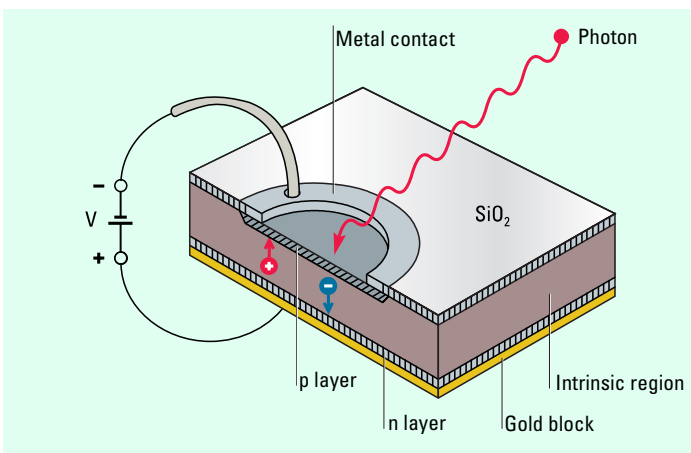

Figure 21
The photodiode detector

Some modern spectrophotometers contain an array of photodiode detectors instead of a single detector. A diode array consists of a series of photodiode detectors positioned side by side on a silicon crystal. Each diode has a dedicated capacitor and is connected by a solid-state switch to a common output line. The switches are controlled by a shift register (see Figure 22). Initially, the capacitors are charged to a specific level. When photons penetrate the silicon, free electrical charge carriers are generated that discharge the capacitors. The capacitors are recharged at

regular intervals that represent the measurement period for each scanning cycle.

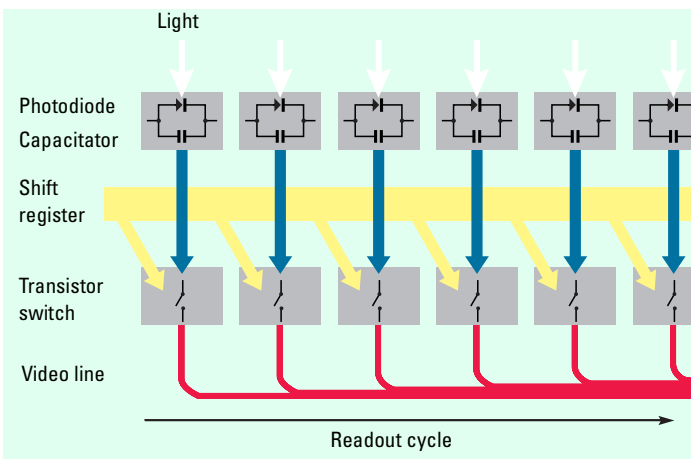

Figure 22
Schematic diagram of a photodiode array

The amount of charge needed to recharge the capacitors is proportional to the number of photons detected by each diode, which in turn is proportional to the light intensity. The absorption spectrum is obtained by measuring the variation in light intensity over the entire wavelength range. The array typically comprises between 200 and 1000 elements, depending on the instrument and its intended application. For example, the diode array of the Agilent 8453 spectrophotometer comprises 1024 detector elements, and the photosensitive area measures approximately 25×0.5 mm. The readout cycle, which corresponds to the illumination time, is 100 ms.

Photodiode array technology is similar to microprocessor technology. Photodiode arrays are complex devices but, because they are solid state, have high reliability.

Optics Either lenses or concave mirrors are used to relay and focus light through the instrument. Simple lenses are inexpensive but suffer from chromatic aberration, that is, light of different wavelengths is not focused at exactly the same point in space. However, with careful design, the chromatic aberrations of individual lenses in an optical system can be used to cancel each other out, and an effective optical system can be constructed with these simple and inexpensive components.

Achromatic lenses combine multiple lenses of different glass with different refractive indices in a compound lens that is largely free of chromatic aberration. Such lenses are used in cameras. They offer good performance but at relatively high cost.

Concave mirrors are less expensive to manufacture than achromatic lenses and are completely free of chromatic aberration. However, the aluminum surface is easily corroded, resulting in a loss of efficiency.

At each optical surface, including the interfaces between components in an achromatic lens, 5–10 % of the light is lost through absorbance or reflection. Thus spectrophotometers ideally should be designed with a minimum number of optical surfaces.

The conventional spectrophotometer

Figure 23 shows a schematic of a conventional single-beam spectrophotometer. Polychromatic light from the source is focused on the entrance slit of a monochromator, which selectively transmits a narrow band of light. This light then passes through the sample area to the detector. The absorbance of a sample is determined by measuring the intensity of light reaching the detector without the sample (the blank) and comparing it with the intensity of light reaching the detector after passing through the sample. As discussed above, most spectrophotometers contain two source lamps, a deuterium lamp and a tungsten lamp, and use either photomultiplier tubes or, more recently, photodiodes as detectors.

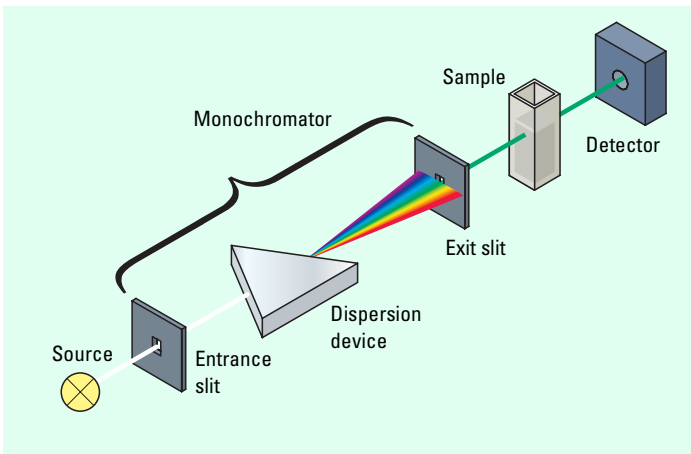

Figure 23
Schematic of a conventional spectrophotometer

This design is well-suited for measuring absorbance at a single point in the spectrum. It is less appropriate, however, for measuring different compounds at different wavelengths or for obtaining spectra of samples. To perform such tasks with a conventional spectrophotometer, parts of the monochromator must be rotated, which introduces the problem of mechanical irreproducibility into the measurements. Moreover, serial data acquisition is an inherently slow process.

The diode array spectrophotometer

Figure 24 shows a schematic diagram of a diode array spectrophotometer. Polychromatic light from a source is passed through the sample area and focused on the entrance slit of the polychromator. The polychromator disperses the light onto a diode array, on which each diode measures a narrow band of the spectrum. The bandwidth of light detected by a diode is related to the size of the polychromator entrance slit and to the size of the diode. Each diode in effect performs the same function as the exit slit of a monochromator.

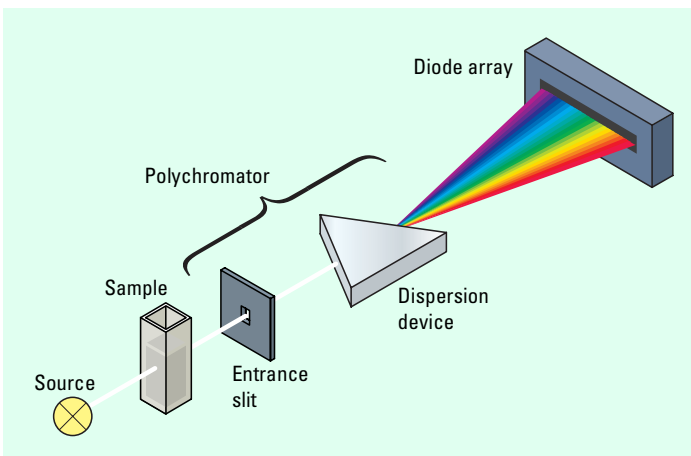

Figure 24
Schematic of a diode array spectrophotometer

The polychromator (entrance slit plus dispersion device) and the diode array are contained in a unit known as a spectrograph. Because the relative positions of the sample and the dispersive element are reversed compared with a conventional instrument, this configuration often is referred to as reversed optics.

To minimize possible photochemical reactions, a shutter is used to block light from the source until a measurement can be performed. When the measurement is initiated, the shutter is automatically opened, and light passes through the sample to the array of diodes. The difference in the intensities of the light reaching the detector with and without the sample is measured as described in “The conventional spectrophotometer” on page 36. A diode array spectrophotometer is inherently very fast owing to its parallel data acquisition and electronic scanning capabilities, has excellent wavelength reproducibility, and is highly reliable.

Configuration Various configurations of spectrophotometers are commercially available. Each has its advantages and disadvantages.

Single-beam design Both conventional and diode array spectrophotometers are single beam. Single-beam instruments are low in cost, and the simple optical system offers high throughput and hence high sensitivity. The reference spectrophotometers used by national standards institutions such as the National Institute of Standards and Technology (NIST) in the United States and the National Physical Laboratory (NPL) in the United Kingdom are single beam.

Diode array spectrophotometers in particular are well-suited to single-beam configuration because spectra are acquired very quickly and because the time interval between blank and sample measurements is minimized. In addition, internal referencing can be used to reduce further the effects of lamp drift (see “Internal referencing” on page 72).

Figure 25 shows the optical system of a modern diode array spectrophotometer, the Agilent 8453. This single-beam configuration has a minimum number of optical components for highest throughput efficiency and contains a 1024-element diode array for measuring the wavelength range from 190 to 1100 nm with good resolution.

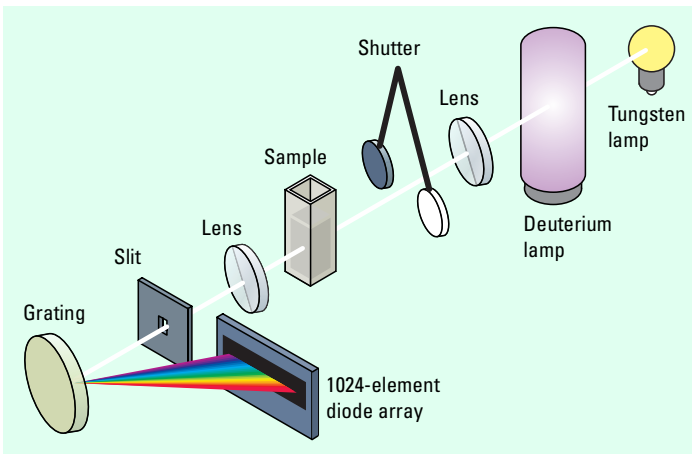

Figure 25
Optical diagram of the Agilent 8453 diode array spectrophotometer

Dual-beam design

In a conventional single-beam spectrophotometer, the blank and the sample are measured consecutively, with an interval of several seconds for a single wavelength measurement and up to several minutes for a full spectrum measurement with a conventional instrument. Lamp drift can result in significant errors over long time intervals.

The dual-beam spectrophotometer was developed to compensate for these changes in lamp intensity between measurements on blank and sample cuvettes. In this configuration, a chopper is placed in the optical path, near the light source. The chopper switches the light path between a reference optical path and a sample optical path to the detector. It rotates at a speed such that that the alternate measurements of blank and sample occur several times per second, thus correcting for medium- and long-term changes in lamp intensity (drift).

Figure 26 shows a schematic of a dual-beam spectrophotometer. Compared with single-beam designs, dual-beam instruments contain more optical components,

which reduces throughput and sensitivity. For high sensitivity, long measurement times may be required. In addition, the more complex mechanical design of the dual-beam spectrophotometer may result in poorer reliability.

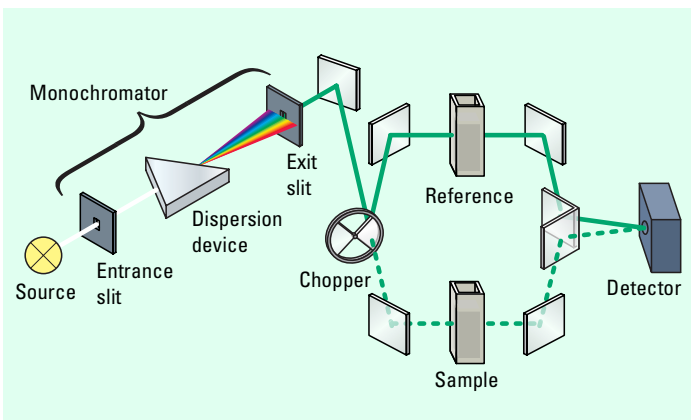

Figure 26
Optical system of a dual-beam spectrophotometer

Traditionally, the higher stability of dual-beam instruments has been a major factor in the design of high-performance spectrophotometers. However, recent advances in lamp and electronics design have improved the stability of the single-beam spectrophotometer and led to the resurgence of this configuration. Single-beam instruments offer higher sensitivity and greater ease of use, with drift typically only a factor of two worse than that of dual-beam instruments.

The first commercially available diode array spectrophotometer, the HP 8450A, was a multibeam design (see Figure 27). The beam director is used to shift the beam alternately through the reference position and as many as four sample positions (for clarity only one is shown in the figure).

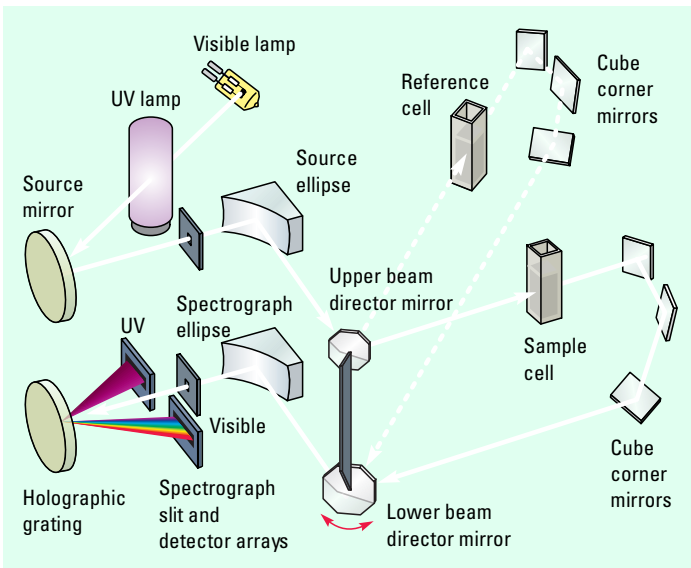

Figure 27
Optical system of the HP 8450A diode array spectrophotometer

Split-beam design

The split-beam spectrophotometer (see Figure 28) resembles the dual-beam spectrophotometer but uses a beam splitter instead of a chopper to send light along the blank and sample paths simultaneously to two separate but identical detectors. This configuration enables the blank and the sample to be measured at the same time. Although the split-beam design is mechanically simpler than the true dual-beam instrument and requires fewer optical elements, the use of two independent detectors introduces another potential source of drift.

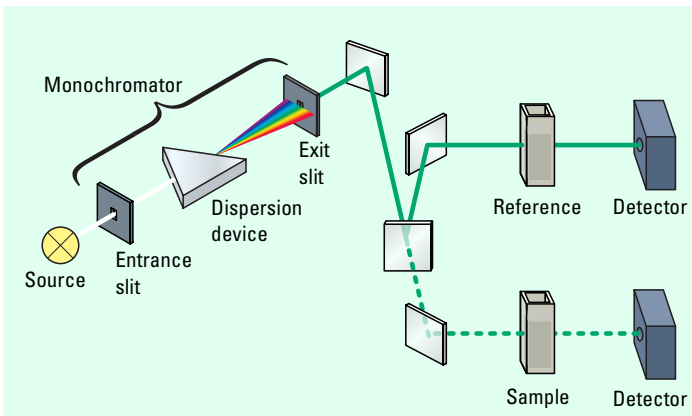

Figure 28
Optical system of a split-beam spectrophotometer

This design provides high stability, although not as high as a dual-beam instrument since two detectors can drift independently, and good noise, although not as good as a single-beam instrument since the light is split so that less than 100 % passes through the sample.

Dual-wavelength design

With a dual-wavelength spectrophotometer, two wavelengths can be measured simultaneously for special applications, such as the study of two concurrent reactions in a sample. The monochromator contains two dispersion devices (in effect transforming it into a duochromator), with the output combined into a single beam. These complex instruments typically are significantly more expensive than conventional spectrophotometers and have been largely replaced by diode array spectrophotometers, which are multiwavelength instruments.

Measuring a spectrum

The degree of interaction of the sample with radiation (transmittance or absorbance) is determined by measuring both the intensity of the incident radiation (without the sample) and the transmitted intensity (with the sample).

These intensities are denoted I_0 and I , respectively, in the equations in “Transmittance and absorbance” on page 6.

Because most samples measured with UV-visible spectroscopy are in solution, the blank should be measured on a cuvette containing the pure solvent used to prepare the sample. This process eliminates from the sample measurement any absorbance due to the solvent.

With a single-beam instrument, the cuvette containing the solvent is placed in the spectrophotometer, and the blank is measured. The sample solution is then measured in the same cuvette. All modern instruments automatically store the reference I_0 values, which are used to calculate absorbance values for the sample.

With a dual- or split-beam instrument, two cuvettes are required. Both cuvettes are initially filled with pure solvent, and a so-called balance measurement is performed. This measurement reflects the difference in absorbance between the two optical paths in use. The sample cuvette is then filled with the sample solution for measurement, and I_0 and I are measured virtually simultaneously. The resulting spectrum is corrected by subtracting the balance spectrum.

Key instrumental parameters

In this section we discuss some instrumental parameters that may affect the accuracy and precision of measured absorbance values (see Appendix A for a detailed definition of the terms accuracy and precision). Sources of error in measurements related to sample handling are described in Chapter 3 “Sample handling and measurement”.

Spectral resolution

Spectral resolution is a measure of the ability of an instrument to differentiate between two adjacent wavelengths. Two wavelengths usually are considered resolved if the minimum between the two peaks of the detector output signal is lower than 80 % of the maximum. This condition is known as the Rayleigh criterion. Figure 29

shows schematically a case for two closely adjacent emission lines (the input to the instrument) and the actual signal that is output from the detector.

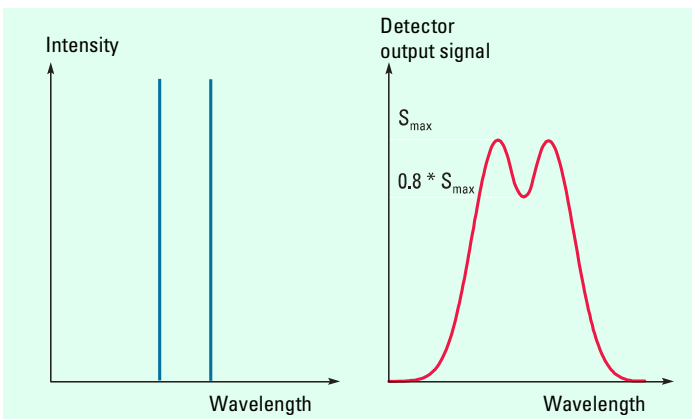

Figure 29
Definition of resolution

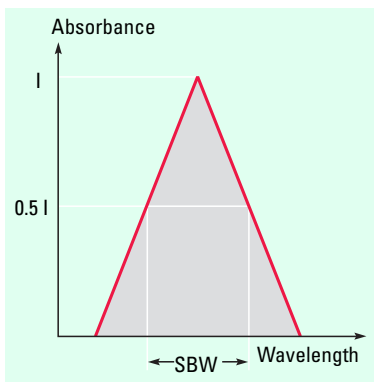

Figure 30
Instrumental spectral bandwidth

Resolution is closely related to instrumental spectral bandwidth (SBW). The SBW is defined as the width, at half the maximum intensity, of the band of light leaving the monochromator (see Figure 30).

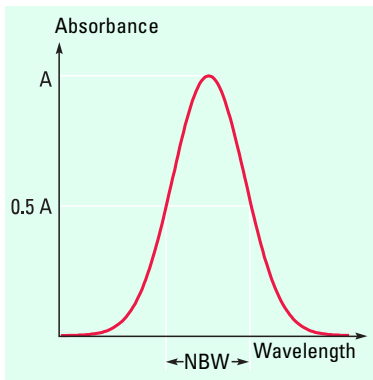

Figure 31
Natural spectral bandwidth

The accuracy of any measured absorbance depends on the ratio of the SBW to the natural bandwidth (NBW) of the absorbing substance. The NBW is the width of the sample absorption band at half the absorption maximum (see Figure 31).

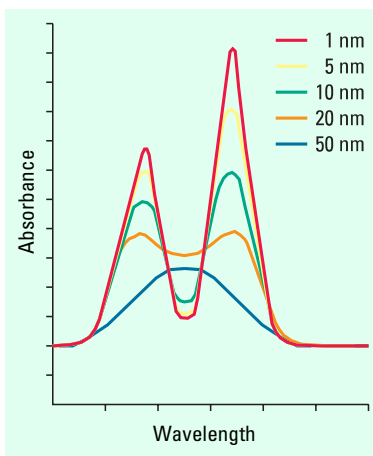

Figure 32
Effect of varying SBW on measured band shape

An SBW/NBW ratio of 0.1 or less will yield an absorbance measurement with accuracy of 99.5 % or better.^{8,9} At an SBW/NBW ratio of higher than 0.1, the measured spectrum becomes progressively more distorted, as shown in Figure 32. Bands may not be resolved correctly, and significant errors in absorbance values will occur at most wavelengths. SBW is primarily a function of the entrance and exit slit widths of the monochromator, and of the dispersion generated by the grating. Resolutions of 0.5, 0.2, and 0.1 nm are not unusual, but higher resolutions cause considerable deterioration in S/N.¹⁸

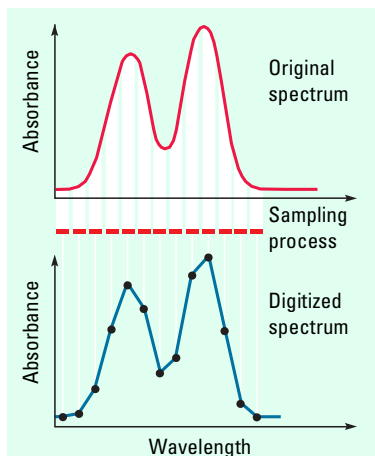

Figure 33
Effect of digital sampling

In modern spectrophotometers, the sampling interval used to digitize the spectrum for computer evaluation and storage also affects resolution (in a diode array spectrophotometer, digitization occurs on the array itself). Figure 33 shows this effect. If the sampling interval is large relative to the SBW, the resolution of the instrument will be degraded. A smaller sampling interval improves resolution but results in much larger spectral files, which may be difficult to manage. In practice, the sampling interval is best set at equal to or slightly smaller than the SBW.

When considering instrumental requirements, it is important to determine what resolution is required. As discussed in Chapter 1 “Principles and applications of UV-visible spectroscopy”, absorption bands in the UV-visible region are normally rather broad, particularly for samples in solution. For approximately 99 % of routine measurements, an SBW of 2 nm is more than adequate to yield accurate absorbance measurements of bands with an NBW of 20 nm or greater.

If an instrument with an SBW of 2 nm is used to measure samples with an NBW narrower than 20 nm (for example, benzene), an error in absolute absorbance measurements will result. This error increases as the NBW decreases (see Figure 32). For absolute absorbance measurements, an instrument with a narrower SBW is necessary. However, most UV-visible measurements are used for quantification, which normally requires only relative measurements (for example, the absorbance of an unknown concentration relative to the absorbance of a standard). A calibration performed using standards, which bracket the concentration of the unknown sample, will yield accurate quantitative results even for very narrow bands.

Wavelength accuracy and precision

The difference between wavelength accuracy and wavelength precision usually is not well understood (see Appendix A for an explanation of the difference between

accuracy and precision). Wavelength accuracy is important for the comparison of measurements made on different instruments. In most UV-visible analyses, however, measurements are made on the same instrument relative to a standard, and wavelength precision (that is, resettability) is most important.

Figure 34 shows the effect of poor wavelength resettability. If a wavelength at the absorption maximum is selected for quantitative measurements, the small wavelength errors that occur in resetting the spectrophotometer to that wavelength will have a minimal effect on the measured absorbance. This method yields the most reproducible quantitative results. On the other hand, the choice of a wavelength on the side of the absorption band, with the same wavelength resetting error, will result in significant errors in measured absorbance. In this case, the quantitative results are unreliable.

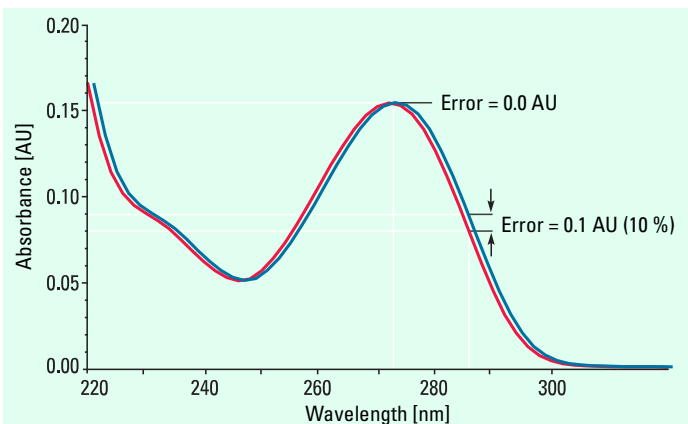

Figure 34
Effect of poor wavelength resettability

All standard texts on UV-visible spectroscopy emphasize that, for accurate quantification, the analytical wavelength must be at the absorption maximum, even though other

wavelengths may yield better selectivity. However, these texts are based on conventional mechanical scanning techniques and do not apply to diode array instruments, which have virtually absolute wavelength resettability.

Photometric accuracy and precision

Assuming good optical and electronic design, only two factors influence photometric accuracy and precision: stray light and noise.

Stray light Stray light is defined as detected light of any wavelength that lies outside the bandwidth of the selected wavelength. The equation used to calculate transmittance and thereby absorbance is:

$$T = (I + I_s) / (I_o + I_s)$$

where T is transmittance, I_o is the intensity of incident light, I is the intensity of transmitted light, and I_s is the intensity of stray light.

The intensity of stray light normally does not depend on that of transmitted light. If I_s remains near constant, it becomes the dominant term at low levels of I . At high absorption, stray light causes a negative bias in instrument response and eventually is the limiting factor for the absorbance, and thereby concentration, that can be measured. The photometric accuracy of the instrument is thus compromised. Figure 35 shows the effect of various levels of stray light on measured absorbance compared with actual absorbance.

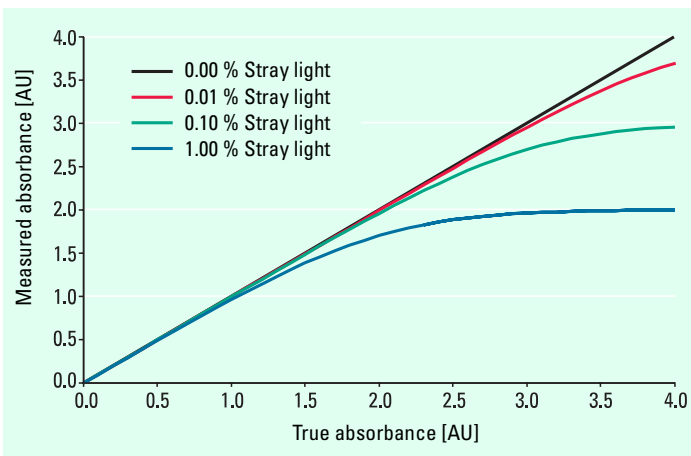

Figure 35
Effect of stray light on measured sample absorbance

Noise A spectrophotometer typically has two noise elements. The first element (photon or Schott noise) results from the statistical distribution of the photons emitted by a light source. It is proportional to the square root of the intensity of light. When low concentration samples with low absorbances are measured, this element may prevent an accurate measurement of the small difference between two high light levels. The second element is inherent to the instrument electronics (detector amplifier, analog-to-digital converter, and so forth) and is independent of the intensity measured. This element becomes significant at high absorbance levels, where the sample signal is very small. It can be minimized through good design.

Noise negatively affects the precision of measurements and, for any single measurement, may introduce errors in accuracy as well. However, noise can be reduced by increasing measurement time (see “Time averaging” on page 65).

Linear dynamic range A frequently quoted and often misunderstood specification is instrument range. In most cases, the instrument range is simply the numerical range an instrument can display. A more useful specification is linear dynamic range, which specifies for a given acceptable deviation from linearity (as a percentage of absorbance) the minimum and maximum absorbance values.

Potential errors at different absorbances can be calculated from stray light and noise.

Thus, percentage error due to stray light is equal to

$$(A_t - A_m)100/A_t$$

where A_t is the true absorbance and A_m is the measured absorbance which are given by

$$A_t = -\log(I/I_o)$$

$$A_m = -\log[(I + I_s)/(I_o + I_s)]$$

where I_o is incident light intensity, I is transmitted light intensity and I_s is the stray light intensity. Figure 35 shows the error curve due only to stray light.

In addition, the measured absorbance may be in error because of the instrument noise.

Thus, error due to noise (%) is equal to

$$(A_t - A_m)/(A_t \times 100)$$

$$\text{where } A_t = -\log(I/I_o)$$

$$\text{and } A_m = A_t + \sqrt{T/100} \times A_{pn} + A_{en}$$

$$\text{or } A_m = \sqrt{T/100} \times A_{pn} - A_{en}$$

where A_{pn} is photon noise in AU, A_{en} is electronic noise in AU, and T is transmittance as a percentage.

The total error at any absorbance is the sum of the errors due to stray light and noise. Figure 36 depicts the total error for an example with photon noise of ± 0.0004 AU and electron noise of ± 0.0001 AU. The plot shows that absorbance measurements made from approximately 0.3 to 1.0 AU have the highest accuracy and precision. The instrumental dynamic range can be determined from the acceptable measurement error.

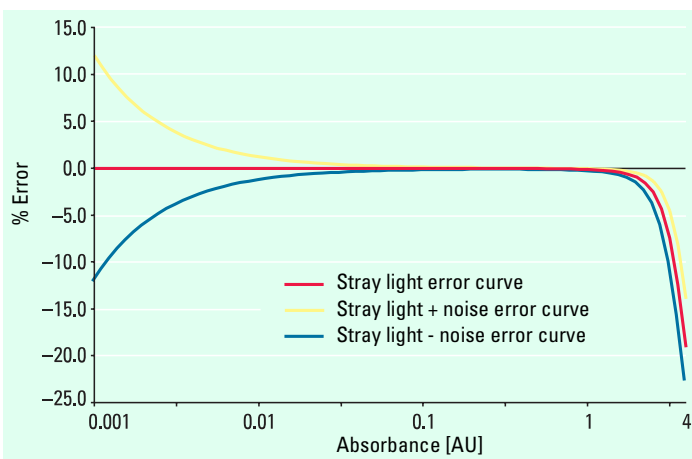

Figure 36
Theoretical absorbance error versus absorbance

Drift Another potential cause of photometric error is drift. Drift normally results from variations in lamp intensity between the measurement of I_0 and the measurement of I . Changes in the instrument electronics also can cause drift. Good

instrumental design can minimize drift, but this effect can reduce the accuracy of results, especially over a long period of time (see Figure 37). With multiwavelength data, the problem of drift can be minimized using techniques such as internal referencing (see “Internal referencing” on page 72).

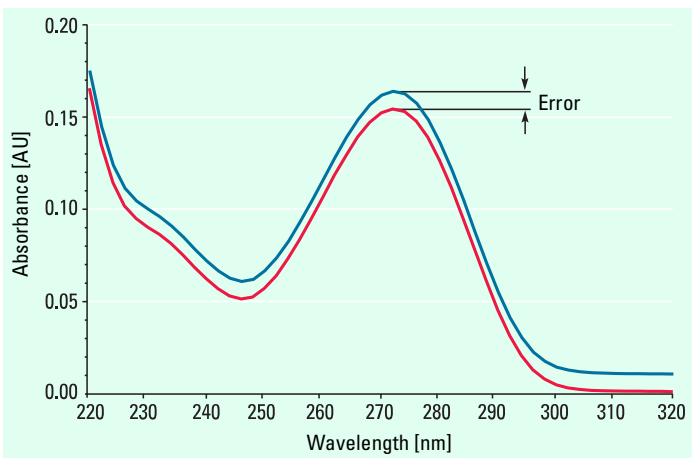

Figure 37
Effect of drift on measured absorbance values

chapter 3

Sample
handling and
measurement

Assuming the instrumental limitations are understood and the spectrophotometer is correctly operated, the largest sources of error in UV-visible spectroscopy are related to sample handling and sample chemistry. In this chapter we discuss potential sources of error and steps to avoid them.

Liquid samples

Cells UV-visible spectroscopy is used primarily to measure liquids or solutions. This mode is simpler and allows more accurate quantitative analysis than do reflectance measurements on solids. With this technique, a cell must contain the liquid or solution in the spectrophotometer sample area.

Material Ideally, cells would be completely transparent at all wavelengths since any absorbance from the cell itself reduces the effective linear dynamic range for the sample. For example, if the upper limit of the instrumental linear range is 2.5 AU but the cell absorbs 1 AU, the remaining usable range for the sample is between 1 and 2.5 AU, that is, only 1.5 AU.

The cells lowest in cost are made of plastic, usually an acrylic. These cells are not resistant to all solvents and absorb strongly below 300 nm, making them unsuitable for measurements in this region. Consistency (absorbance and

path length) can vary from cell to cell, depending on the manufacturer.

Glass cells are slightly more expensive than plastic cells but are more durable and, with proper care, can provide years of use. Glass absorbs strongly below 320 nm and thus is not suitable for measurements in this area.

Fused quartz cells are reasonably transparent down to 210 nm. The best cells are made of high-purity fused synthetic silica and are reasonably transparent down to 190 nm.

Figure 38 shows the absorption characteristics of cells of different materials. Note that all materials exhibit at least an approximately 10 % loss in transmission at all wavelengths.

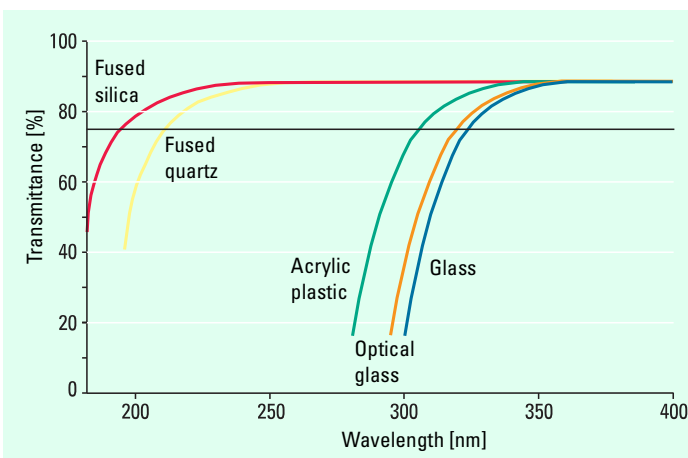

Figure 38
Optical transmission characteristics of some cell materials

Cell types A wide range of cells are available, and only the most important are described here. The most frequently used cell is the open-topped rectangular cell (see Figure 39a). These cells are available in path lengths from 1 to 100 mm, but the most popular path length by far is 10 mm. Almost all

rectangular cells have an external width of 12.5 mm. When sample volume is limited, apertured cells are often used. (see Figure 39b).

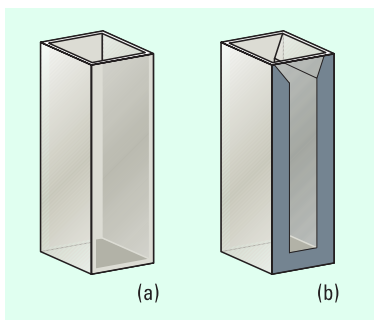

Figure 39
Standard (a) and apertured (b)
cells

When sample volume is extremely limited, microcells can be used that reduce the aperture of the sample area to a very small cross section (typically 2×2.5 mm), as shown in Figure 40a. Only approximately 60 μl of sample are required for measurement. With special ultramicrocells, sample volumes down to 5 μl can be measured. For automated application, flow-through cells (see Figure 40b) are used. Modern cells are connected to sample transfer tubing with screw fittings. Flow cells of various aperture sizes and geometries are available in a wide range of path lengths.

With apertured cells and microcells, part of the light beam is blocked, throughput is reduced, and sensitivity is to some extent compromised. The loss of sensitivity depends on the degree of aperturing and on the optical geometry.

Sources of error

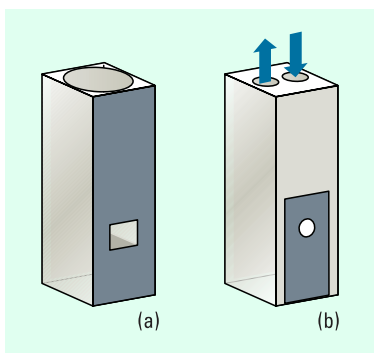

Figure 40
Micro (a) and flow-through (b)
cells

If cells are properly designed and used, their contribution to errors in absorbance measurements should be minimal. However, the analyst should be aware of a few potential sources of error.

Because measured absorbance depends on path length, the precision of the path length is important in absolute measurements. Cell path length tolerances for cells of good quality are ± 0.01 mm for path lengths from 0.5 to 100 mm.¹¹ For maximum quantitative accuracy, the same cell should be used for both standard and sample measurements.

When placed in the sample beam, a cell becomes an active optical component. Nonflat or nonparallel optical surfaces can deviate the optical beam and cause apparent absorbance errors (see “Sample geometry” on page 63). The best cells have very flat and very parallel optical surfaces

that minimize their influence as optical components. The cell always should face the same direction in a cell holder to ensure that any cell optical effects are identical for both blank and sample measurements.

With apertured cells, the parts of the cell that do not contain the sample must be properly masked (as shown in the figures) to avoid unwanted transmissions and reflections through the side walls. If unmasked cells are used, the measurements will be in error. The degree of error depends on the optical geometry in the sample area. If the optical beam is highly focused so that a large proportion of the light passes through a very small opening in the cell, results with unmasked cells will be reasonably accurate because the optics are in effect self-masking. On the other hand, if the optical beam is broad and collimated (parallel), much of the light will pass through the walls of the cell instead of through the sample, and measurements will be inaccurate.

Care of cells Cells should be handled carefully to prevent scratching. Care should be taken to avoid touching the optical surfaces with the fingers, as oil from fingerprints can cause significant absorbance. If the optical surfaces of the cell become mildly contaminated, the cell can be wiped carefully with photographic tissue. If a cell becomes seriously contaminated, it may be cleaned with a mild sulfonic detergent or with special cleaning fluid available from cell manufacturers. In severe cases, treatment with hydrochloric or nitric acid can be used.

Choice of solvent The ideal solvent for the preparation of sample solutions would dissolve all types of compounds, would be nonflammable and nontoxic, and would be completely transparent at all wavelengths. Distilled water approaches the ideal but is not suitable for many nonpolar organic compounds. Table 4 lists some of the most commonly used solvents. With the exception of water, these solvents all exhibit a cut-off wavelength in the UV range below which

they absorb too strongly for sample measurements to be performed.

Table 4 Properties of some common solvents

| Solvent | Polarity* | Cut-off wavelength (nm)** | Hazard*** |
|--------------------|-----------|---------------------------|-----------|
| Distilled water | 78.5 | < 195 | none |
| Hexane | 1.9 | 199 | F |
| Ethanol (absolute) | 24.3 | 207 | F |
| Methanol | 32.6 | 210 | F |
| Cyclohexane | 2.0 | 211 | F |
| Chloroform | 4.8 | 246 | F/T |
| Dimethylsulfoxide | none | 270 | H |
| Acetone | 20.7 | 331 | F |

* Dielectric constant at ambient temperature

** Wavelength at which transmittance of 10-mm path length is < 25 %

*** F = flammable; T = toxic; H = health hazard

With volatile organic solvents, such as acetone or methylene chloride, it is advisable to use a stoppered cell to eliminate evaporation, which can result very quickly in changes in concentration.

Effect of solvent, concentration, pH, and temperature

A number of factors, including the solvent used as well as the concentration, pH, and temperature of the sample, can affect the position and intensity of absorption bands of molecules. These parameters should be controlled to ensure maximum precision and when comparing spectra measured under different conditions.

The polarity of a solvent can modify the electronic environment of the absorbing chromophore. In general, the magnitude of the shift can be correlated with solvent

polarity. Thus, for example, the absorption maximum of acetone can vary from 259 to 279 nm, depending on the solvent used. For comparative analysis, a single solvent should be used for all measurements.

Concentration normally affects only the intensity of bands. At higher concentrations, however, molecular interactions (for example, dimerization) may cause changes in the shape and position of the absorbance band. These changes in turn affect the linearity of the concentration versus absorbance relationship and may lead to inaccurate quantitative results.

The effects of pH on absorbance spectra can be very large and result primarily from the shifting of equilibrium between two different forms. For example, pH indicators visually change color at different pH values. If the spectrum of the sample under study is found to be affected by pH, a buffer should be used to control this parameter. Note, however, that most buffers themselves exhibit significant absorbance, which may affect the wavelength range over which measurements can be performed.

Temperature also can affect UV-visible measurements. Simple expansion of the solvent, especially for some organic solvents, may be sufficient to change the apparent absorbance and thereby the accuracy of quantitative results. In addition, temperature may affect equilibria, which can be either chemical or physical. A good example of a physical equilibrium is the denaturation of nucleic acids as temperature is increased, which changes absorptivity. Finally, notably for organic solvents, changes in refractive index with temperature can be significant. When convection currents cause different temperatures to occur in different parts of the cell, the resulting Schlieren effect can change the apparent absorbance. If temperature is found to have a significant effect on the measurements, the sample temperature should be controlled using a thermostatted cell holder. This cell holder may be a simple water-jacketed holder used in conjunction with a circulating water bath, or a more sophisticated Peltier temperature

controller. With organic solvents, it is advisable to use a stoppered cell to minimize the Schlieren effect.

Solid samples

A number of factors can interfere with the accurate and precise measurement of transparent solid samples such as glasses or crystals.

No reference

Often solid samples are measured in order to determine the spectrum of, or to quantitate, one component in the solid matrix. However, a sample of the matrix that does not contain the analyte is not always available. In this case, the blank measurement must be performed on air since a true blank measurement (matrix without analyte) is not possible. This process at best will result in a constant offset at all wavelengths and at worst in a measured spectrum that is a composite of the analyte and the matrix. Accurate quantitative analysis is possible if two or more standards are available and if a calibration curve that is not forced through zero is used. The intercept on the y-axis then represents the absorbance due to the matrix. If multiple standards are not available, internal referencing using a reference wavelength at which no analyte absorbance occurs is often a viable alternative.

Refractive index

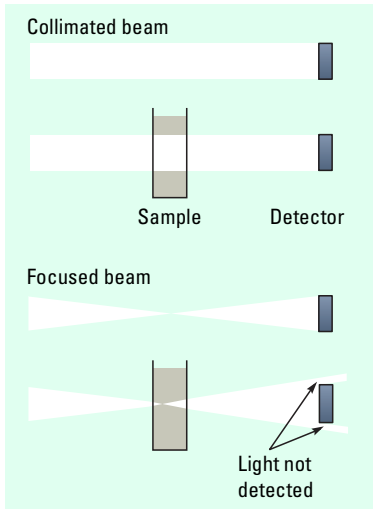

Figure 41
Effect of refractive index

The lack of a reference sample also causes a significant change in the refractive index between the blank (air) and the solid sample. If the optical beam is collimated perpendicular to the sample, this effect is unimportant. If, however, the beam is focused, the solid sample becomes an active optical component and alters the optical path length. This change in path length may in turn cause a significant change in the degree of illumination of the detector between the blank and the sample (see Figure 41), resulting in an apparent absorbance error. Such a problem is very difficult to detect and, if the instrument is a focused-beam design, has no simple solution. However, this effect can be minimized by placing the sample as close to the detector as possible.

Sample geometry

Solid samples often may be glass or molded plastic filters or lenses (for example, sunglass lenses). Such samples are active optical components in the system and will deviate or change the focal length of the light beam. As a result, the detector fails to detect some of the light (see Figure 42), which is then measured as an apparent absorbance. This effect can be tested for by rotating or reversing the sample in its holder and can be minimized by placing the sample as close to the detector as possible.

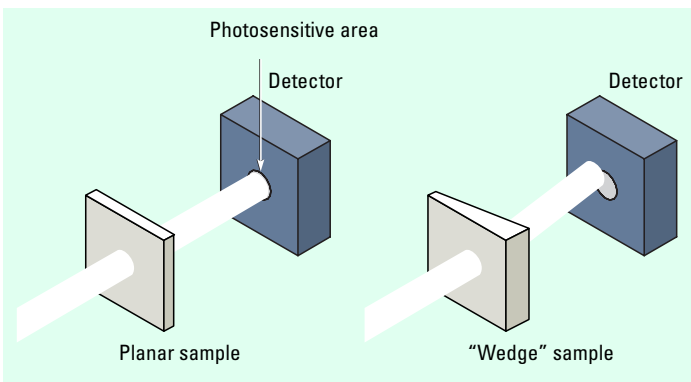

Figure 42
Effect of nonplanar sample geometry

Weak absorbance

A recurring problem in analytical chemistry is low sensitivity, which may be due to low concentrations of the sample or to very weak absorptivity of the analyte. At low absorbances, noise in the measurement results in a loss of precision such that any single measurement may be inaccurate. Reducing the noise level directly improves the precision of results. Noise specification should be a key parameter in selecting a spectrophotometer, but note that varying the measurement parameters will reduce noise level.

Changing slit width

If the spectrophotometer has a variable slit width, the noise level can be reduced by increasing the slit width to allow more light through the optics. This increase in width yields better S/N but reduces instrument resolution.

Time averaging

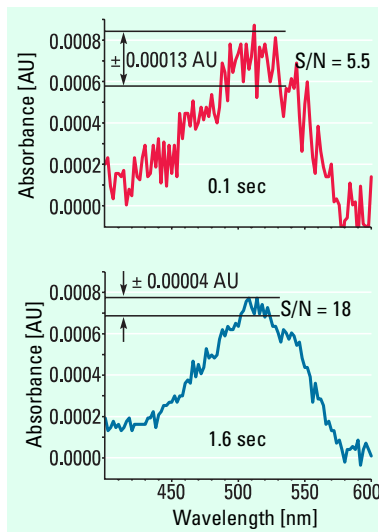

Figure 43

Effect of integration time on S/N

Taking the average of the data points reduces noise by the square root of the number of points averaged. Figure 43 shows the improvement in S/N with increasing integration time for a dyestuff at very low concentration. The measurements were performed using a diode array spectrophotometer with integration times of 0.1 and 1.6 s. Actual improvement is close to the expected theoretical improvement of four. Note that extending the integration time will improve sensitivity only until other effects, such as drift, become dominant.

Wavelength averaging

Another averaging technique is wavelength averaging. Figure 44 shows a broad absorption band. Conventional quantitative measurements would be performed at the absorption maximum. If data at all wavelengths is available, additional values on either side of the maximum can be averaged. The reduction in noise is equivalent to the square root of the number of data points. However, as more data points are added, the average absorbance is reduced, which has a negative effect on the signal. For a given absorption bandwidth, a certain number of data points will yield optimum S/N (see Figure 44).

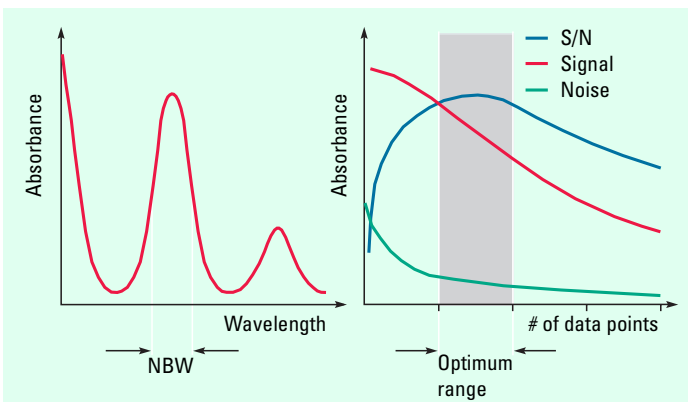

Figure 44
Effect of wavelength averaging on S/N

Drift also affects the accuracy of absorbance measurements. Internal referencing (see “Internal referencing” on page 72) can be used to improve precision and accuracy at low absorbance levels.

Strong absorbance

When samples absorb too strongly, the linear dynamic range of the instrument is exceeded, and the relationship between absorbance and concentration becomes nonlinear (see “Linear dynamic range” on page 51). The easiest solution to this problem is to dilute the sample to an absorbance level within the linear dynamic range. With solid samples, however, this is not possible. Moreover, any sample handling step, even dilution, introduces error and thus may be better avoided. An alternative is to select one or more wavelengths on the side of the absorbance band, where absorptivity is lower (see Figure 45). When the wavelength of the absorbance maximum (241 nm) is used for calibration, a maximum concentration of approximately 0.26 mg/ml can be measured with reasonable accuracy. However, switching to the absorbance on the side of the

band (266 nm) enables concentrations of up to 5 mg/ml to be measured with equal accuracy. A prerequisite for use of this technique is excellent wavelength reproducibility (see “Wavelength accuracy and precision” on page 47).

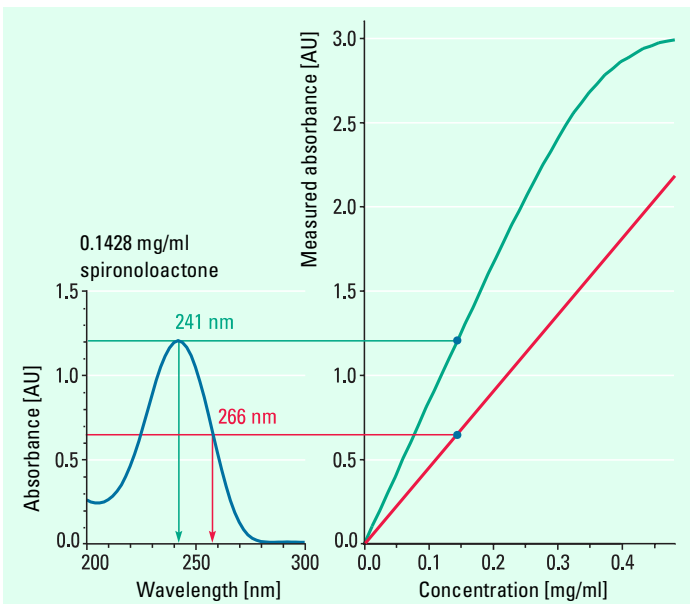

Figure 45
The use of wavelength switching to increase dynamic range

Interference

Types of interference Ideally, the absorbance that occurs during UV-visible measurements should be due only to the target analyte. In practice, however, absorbances that interfere with the measurements often occur for chemical or physical reasons.

Other absorbing compounds The presence of any other compound that absorbs in the same region as the target compound will result in an error in the absorbance measurement. In some cases, only a single known interfering compound, for example a by-product from the synthesis of a pharmaceutical product, is present. In other cases, multiple absorbing species, many of them unknown (for example, biological samples such as blood), may cause a broad matrix absorption.

Scattering A recurring problem in pharmaceutical and biological analyses is scattering caused by particles suspended in solution. In pharmaceutical analyses, these particles are usually the excipients or fillers used in tablet or capsule formulations. The scattering of radiation results in an apparent background absorbance that interferes with absorbance measurements. Filtering samples prior to measurement eliminates scattering but may not always be practicable, and the analyst often must work with spectra that include a scattering component.

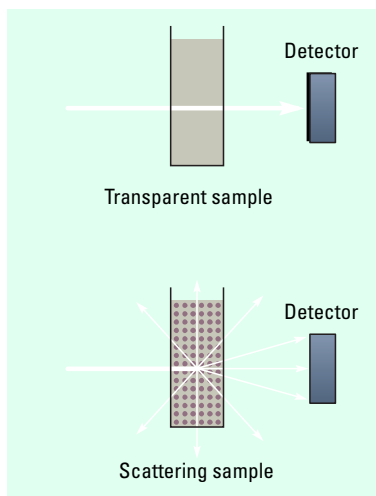

Figure 46
Scattering

Scattering causes an apparent absorbance because light, instead of passing through the solution to the detector, is scattered at an angle. Therefore, even if no absorption occurs, less light reaches the detector, as shown in Figure 46.

In the UV-visible part of the spectrum, two types of scattering can be observed. Rayleigh scattering occurs when the particles are small relative to the wavelength of light and is inversely proportional to the fourth power of the wavelength. Tyndall scattering occurs when the particles are large relative to the wavelength of light and is inversely proportional to the square of the wavelength. In chemical systems, the exponent of the wavelength may range from -4 to -2, depending on the distribution of particle sizes:

$$A_{\text{scatter}} \propto 1/\lambda^n$$

where A is absorbance due to scatter, λ is wavelength, and n is the order of scattering. This relationship causes the error due to scattering to increase at lower wavelengths, as shown in Figure 47.

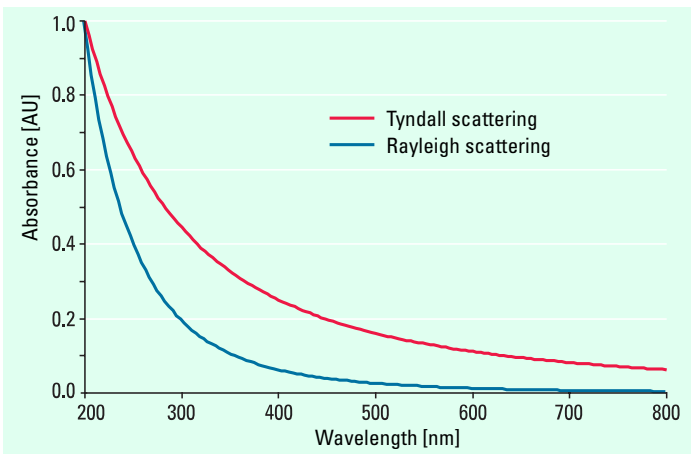

Figure 47
Scatter spectra

The magnitude of the scattering effect can be reduced by placing the sample as close as possible to the detector. However, with significant scattering, light is lost and the sensitivity and accuracy of quantitative analysis are seriously impaired.

Correction techniques

A number of correction techniques can be used to eliminate or reduce interference errors. In general, if the source of the error is known and is consistent from sample to sample, the error can be eliminated. On the other hand, if the source is unknown and varies from sample to sample, the error can be reduced but not eliminated. Correction techniques always require data from at least two wavelengths. The more sophisticated correction techniques require multiwavelength or spectral data.

Isoabsorbance When a known interfering component with a known spectrum is present, the error introduced by this component at the analytical wavelength for the target analyte can be eliminated by selecting a reference wavelength at which the interfering compound exhibits the same absorbance as it does at the analytical wavelength. The absorbance at this reference wavelength is subtracted from the absorbance at the analytical wavelength, as shown in Figure 48. The residual absorbance is the true absorbance of the analyte.

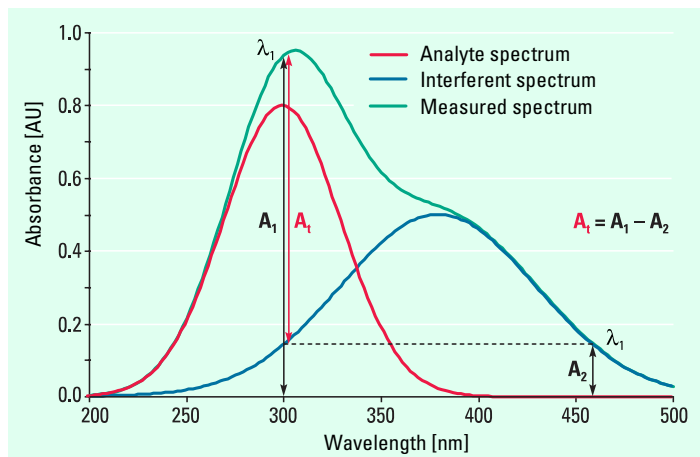

Figure 48
Isoabsorbance correction

This technique is less reliable when the spectra of the analyte and of the interferent are highly similar. Moreover, it can correct for only one interferent.

Multicomponent analysis An extension of isoabsorbance is multicomponent analysis, as described in “Multicomponent analysis” on page 21. Here, spectra of the interferent or interferents must be measured as standards. This technique can be applied successfully when the spectra overlap considerably and when more than one interferent is present.

Background modeling Background modeling is appropriate when the interference is due to a physical process (most often scattering) in which the interference at the analytical wavelength can be estimated by extrapolation from modeling at another wavelength range. A portion of the spectrum where the apparent absorbance is due only to interference is selected. A polynomial is then fitted to this part of the spectrum using a least squares fit to the logarithm of the absorbance:

$$A = a\lambda^n$$

$$\log(A) = \log(a) + n\log(\lambda)$$

where A is absorbance, λ is wavelength, n is the order of the relationship between absorbance and wavelength, and a is a constant. The background absorbance at all other wavelengths can be estimated using the coefficients determined from the fit. These values are then subtracted from the measured values to give the absorbances due to the analyte, as shown in Figure 49.

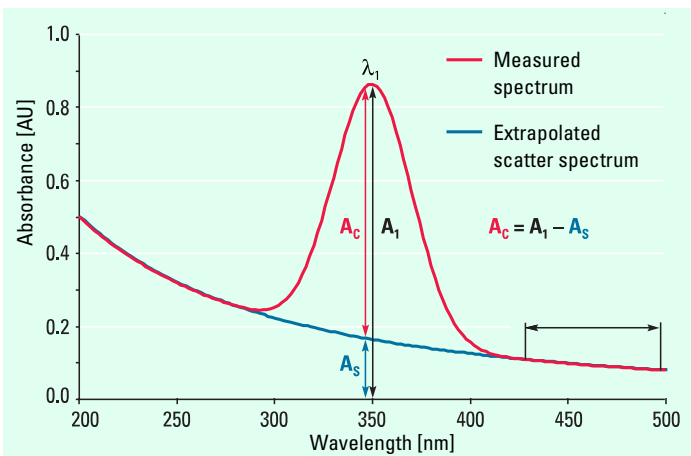

Figure 49
Background modeling

Internal referencing One of the simplest correction techniques is internal referencing, which uses a single reference wavelength. This method is most often used when a baseline shift occurs between measurements. In general, it is best to choose a reference wavelength as close as possible to the analytical wavelength but with no significant absorbance from the analyte. The absorbance at the reference wavelength is subtracted from the absorbance at the analytical wavelength. Any interference that is constant at all wavelengths is corrected for, as shown in Figure 50. Although in practice interference usually is not constant at all wavelengths, this simple technique often yields surprisingly good improvements in accuracy.

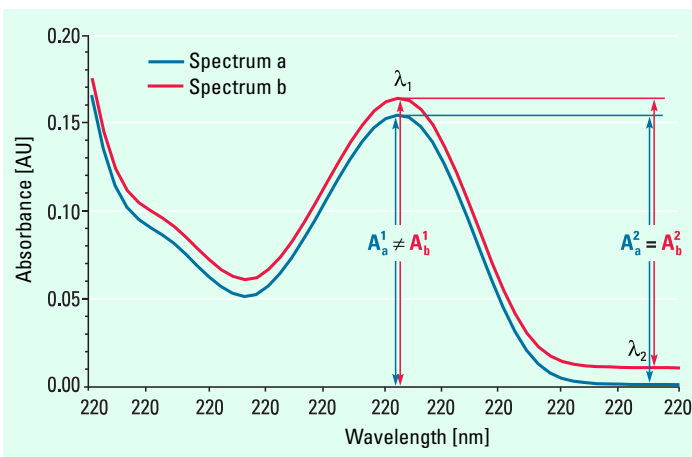

Figure 50
Internal referencing

Three-point correction The three-point, or Morton-Stubbs, correction uses two reference wavelengths, usually those on either side of the analytical wavelength. The background interfering absorbance at the analytical wavelength is then estimated using linear interpolation (see Figure 51). This method represents an improvement over the single-wavelength reference technique because it corrects for any background

absorbance that exhibits a linear relationship to the wavelength. In many cases, if the wavelength range is narrow, it will be a reasonable correction for nonlinear background absorbances such as that resulting from scattering or from a complex matrix.

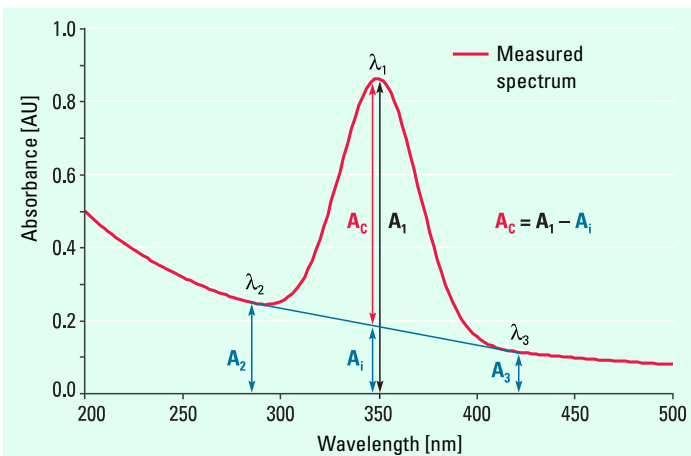

Figure 51
Three-point (Morton-Stubbs) correction

Derivative spectroscopy Owing to two of its properties, derivative spectroscopy can be used to reduce or eliminate background interference from a wide range of sources. First, any interference components that exhibit a directly proportional relationship to different orders of wavelength with the general form

$$A = a_0 + a_1\lambda^1 + \dots + a_n\lambda^n$$

are eliminated through the use of increasingly higher orders of derivatives. Thus a constant baseline offset (a_0) is eliminated by the first derivative, a background absorbance that increases linearly with wavelength is eliminated by the second derivative, and so on. Unfortunately, only the constant baseline offset is common in UV-visible spectroscopy.

Second, and perhaps more important than the first property, derivatives discriminate against broad absorbance bands relative to narrow absorbance bands. This discrimination results from the fact that the amplitude (D^n) of a Gaussian band in the n th derivative is inversely proportional to the original bandwidth (W) raised to the n th degree:

$$D^n \propto \frac{1}{W^n}.$$

Thus for two coincident bands of equal intensity but different bandwidth in the zero order, the n th derivative amplitude of the sharper band (X) is greater than that of the broader band (Y) by a factor that depends on the relative bandwidth and on the derivative order:

$$\frac{D_X^n}{D_Y^n} = \frac{W_Y^n}{W_X^n}$$

Figure 52 shows the effect of taking derivatives of two bands with NBWs of 160 and 40 nm, respectively. In absorbance mode, these bands have equal amplitude. In the first derivative, the narrower band has 4 times greater amplitude, and in the second derivative it has 16 times greater amplitude. This property improves the accuracy of quantification of any narrow band component in the presence of any broadband component. The latter may be an interfering component, as is shown in Figure 52.

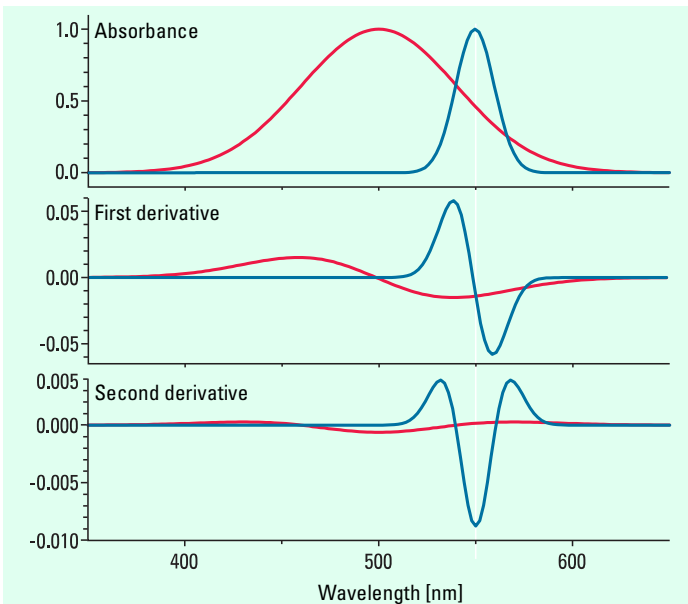

Figure 52
Discrimination against broad bands by derivative spectroscopy

The spectrum resulting from scattering is also broadband, and the use of derivatives can reduce its contribution as well. For example, Figure 53 shows an absorbance band with an NBW of 40 nm and the same band in the presence of a scattering background. Without any correction, the amplitude at 500 nm is 1.0920 A instead of 1.0 A because of the scattering contribution. Quantification at this wavelength results in an error of + 9.2 %. Taking the first derivative reduces the contribution from the scattering component such that, using peak maximum to minimum, the signal in the presence of scattering is 0.02992 A instead of 0.03024—a quantification error of only - 1.1 %.

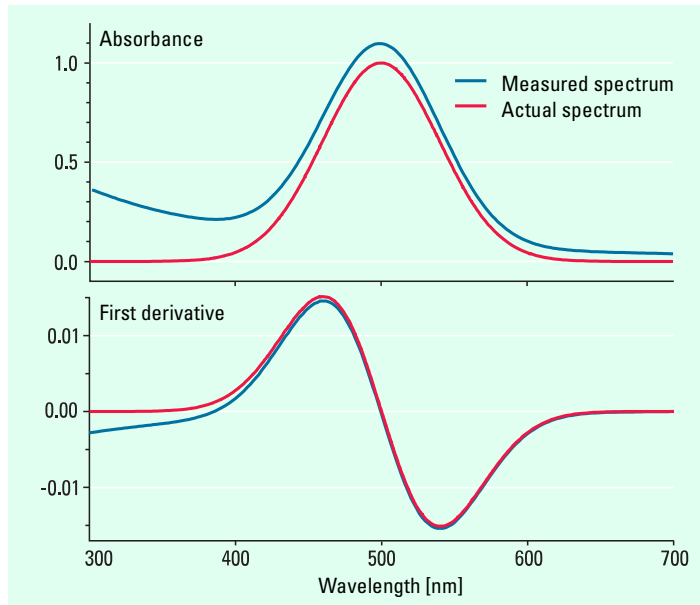

Figure 53
Scatter correction by derivative spectroscopy

Usually, however, the analytical problem cannot be defined simply as scattering, baseline shift, or unwanted broad absorbing components. Rather, a combination of two or more of these effects results in a broad absorbing background matrix. Derivative spectroscopy is an excellent tool for reducing or eliminating these difficult-to-characterize sources of error.

Photochemical problems

Fluorescence Some samples fluoresce, that is, they emit light over a wavelength range when irradiated with light of a shorter (more energetic) wavelength. This emitted light results in an error in the absorbance measurement. The position and magnitude of the error depend on whether the instrument has conventional forward optics or reversed optics.

In a conventional forward optics instrument, the sample is illuminated with light of varying wavelengths over time. As the excitation wavelength range is scanned, absorption occurs, initiating the fluorescence process that emits light at longer wavelengths. Because the detector cannot differentiate among the individual wavelengths, the absorbance measured at the excitation wavelength is too low (see Figure 54). As the emission wavelength range is scanned, no fluorescence occurs, and the absorption measurements are thus accurate.

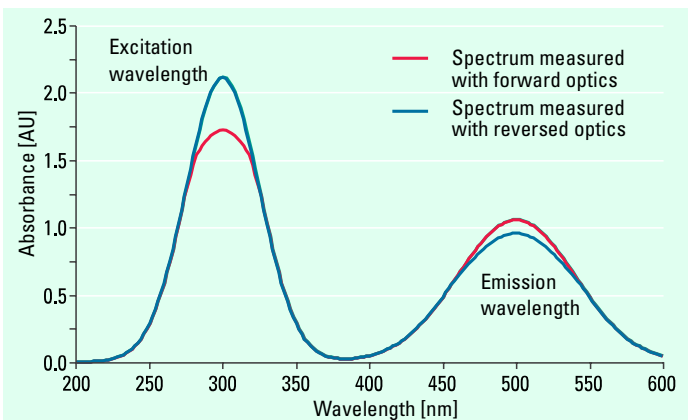

Figure 54
Effect of fluorescence on the measured absorbance spectrum

In a reversed optics instrument, the sample is illuminated with all wavelengths of light simultaneously, including light at the excitation wavelength. The sample therefore fluoresces and emits light but, because the wavelength selection occurs after the light has passed through the sample, the emitted light is directed to the correct wavelength. The absorbance measured at the emission wavelength is therefore too low (see Figure 54), but the absorbance measured at the excitation wavelength is correct.

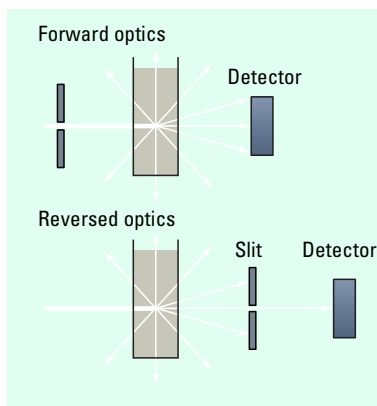

Figure 55
Acceptance angles and magnitude
of fluorescence error

An additional factor that affects the magnitude of the error is the so-called acceptance angle of the detector, as shown in Figure 55. The fluorescent light is emitted in all directions. If the acceptance angle is wide, a significant portion of the fluorescent light will reach the detector. Conversely, if the detector acceptance angle is narrow, only a small amount of the fluorescent light will reach the detector, and the absorbance error will be correspondingly small. Reversed optics instruments have a narrow detector acceptance angle and thus are less susceptible to fluorescence error.

Placing a filter in the light beam can eliminate the error due to fluorescence. In a conventional instrument, the filter is placed between the sample and the detector to filter out the emission wavelength or wavelengths, whereas in a reversed optics instrument, the filter is placed between the source and the sample to eliminate excitation wavelengths.

Sample decomposition

Some samples are sensitive to photochemical reaction, especially when exposed to low-wavelength UV light. In extreme cases, a filter may be necessary to eliminate this light.

chapter 4

Method
development
and validation

An awareness of the errors that can be introduced by the instrument, by sample handling and by the sample itself enables you to develop analytical methods that minimize their effect on results. In this chapter we review criteria for defining a good method and strategies for finding optimum method parameters.

Method development

Because most UV-visible applications are single-component quantitative analyses, in this chapter we focus on the optimization of such methods. Method development involves selecting the wavelength or wavelengths that yield the best results for a particular analysis on a particular instrument. Here, best is defined by such parameters as accuracy, precision, sensitivity, linearity, range, selectivity, and ruggedness. Because all of these parameters cannot be optimized at the same time, the parameter or parameters for optimization must be determined and the requirements defined prior to analysis. Until recently, instrumentation limited the choice of wavelength (owing mainly to problems of wavelength reproducibility) and/or suitable tools for the comparison of choices were not available. These limitations have been eliminated in modern instruments.

NOTE: Method development involves the use of various statistical tools. An in-depth discussion of how these tools are calculated and of their relative advantages and disadvantages is beyond the scope of this primer, but detailed information may be found in the references.¹²⁻¹⁵

Linearity *Linearity is the ability of the method to produce test results that are proportional, either directly or by a well-defined mathematical transformation, to the concentration of analyte in samples within a given range.*¹⁶

For UV-visible measurements, the usual linear relationship is Beer's law, which states that the absorbance of a solute is directly proportional to its concentration (see "Beer's law" on page 16). A linear calibration curve relating absorbance to concentration should have the form:

$$A = kc$$

where A is absorbance, c is concentration, and k is the calibration factor (the slope of the calibration curve). Thus testing for linearity in effect tests how well our theoretical model (Beer's law) fits the actual measurements.

Theoretically, an absorbance measurement of only one standard of known concentration is required in order to calibrate for quantification. The measured absorbance value divided by the concentration gives the slope. A number of instrumental and sample parameters (see Chapter 2 "Instrumentation" and Chapter 3 "Sample handling and measurement") can cause deviations from Beer's law, and significant quantitative errors can result if the calibration curve is not accurately characterized (see Figure 56). However, because these deviations are wavelength dependent, selection of the appropriate wavelength can minimize their influence on results.

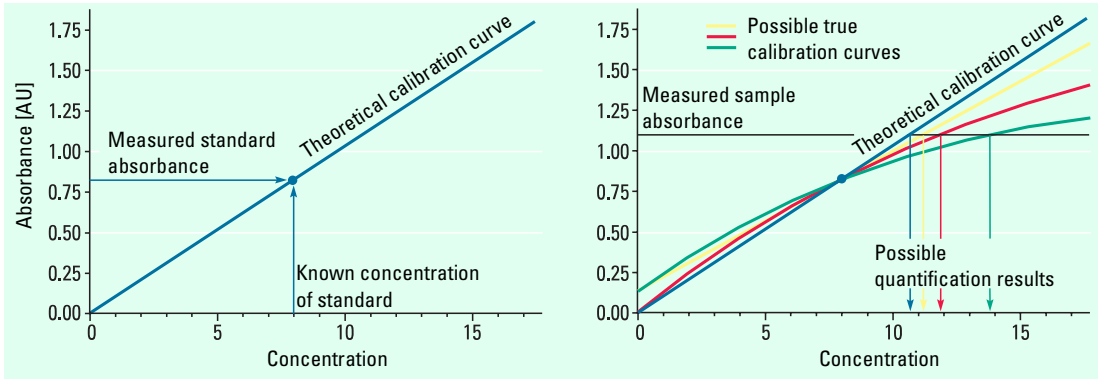

Figure 56
Potential errors resulting from inadequate calibration

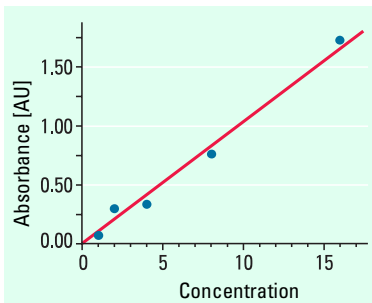
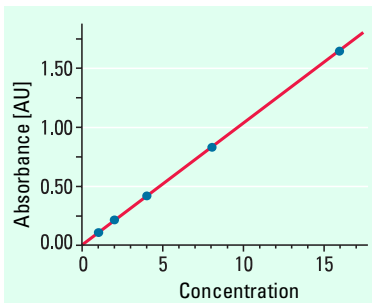

Figure 57
Calibration data sets

To construct a calibration curve, the spectra of a set of at least three standard analyte solutions should be measured. The concentrations of the standard solutions should bracket the expected concentration range of the samples for analysis. Ideally, all measured standard values would lie on a straight line, but in practice the values always exhibit some scatter (see Figure 57). A statistical method must be applied to find the best fit of the calibration curve to the data and, in a second step, to determine which type of calibration curve gives the best fit. The statistical method most often used is linear regression, which is also known as the least squares method.

To compare two calibration curves, a measure of the goodness of the fit of the standards to the line is required. Several statistical values, including correlation coefficient, standard error of regression, and uncertainty can be used to obtain this measurement. Of these, the correlation coefficient is the most popular. This value always lies between + 1 and - 1. A value of + 1 indicates a perfect linear relationship between absorbance and concentration, with A increasing. A value of - 1 also indicates a perfect linear

relationship, but with A decreasing (which can occur if derivative data is used). A value of 0 indicates that there is no correlation between absorbance and concentration.

To determine the best wavelength or combination of wavelengths, the spectra of a set of pure standards with a wide range of concentrations are measured. A linear calibration curve is applied to each wavelength, and the chosen statistic for the assessment of linearity is calculated. For quickest evaluation, a graphical plot of the linearity statistic versus wavelength is useful.

Figure 58 depicts the spectra of four yellow dye standards and the corresponding correlation coefficient spectrum for a simple linear calibration curve. The best calibration in terms of linearity is achieved at the point at which the correlation coefficient approaches unity. In this example, the wavelength of maximum absorbance (414 nm) is not identical to the wavelength (402 nm) that gives the best linearity. Typically, correlation coefficient values of better than 0.999 can be expected.

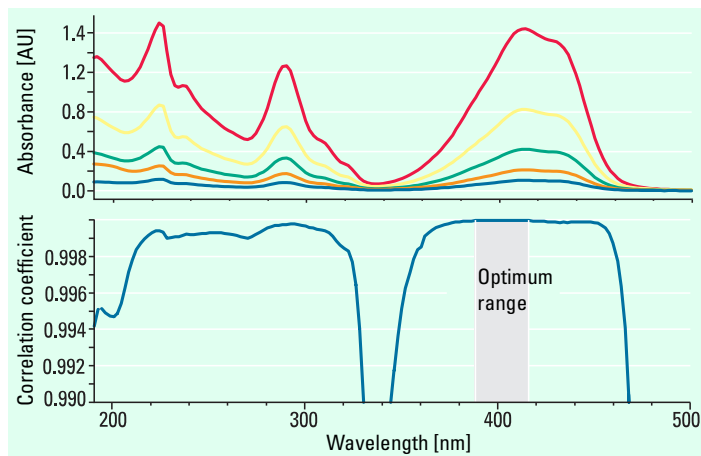

Figure 58
Selecting the wavelength or wavelengths for best linearity

If an individual wavelength does not give the required degree of linearity, a combination of wavelengths may be used. For example, the use of an internal reference wavelength to eliminate baseline shift errors in measurements will improve results.

If the desired degree of linearity cannot be achieved with a simple linear calibration curve, a different type of calibration curve can be applied to minimize the influence of the nonideality on the results. Typically, equations of the form:

$$A = a + kc$$

$$A = kc + k'c^2$$

and

$$A = a + kc + k'c^2$$

are used. Again, the correlation coefficient or another statistical tool should be used to assess the relative quality of the calibration curves. Note that when calibration curve types with higher degrees of freedom are used, more standards are required in order to characterize properly the curve.

For multicomponent analyses, Beer's law is also assumed. Here, however, the calculation model includes the law of additivity to explain total absorbances at each wavelength. The simple linearity test described above cannot be used. Instead, the standard deviation of the residual can be used to test how well our standard set fits the measured spectrum. This value is the sum of the squares of the differences at each wavelength between the measured spectrum and the calculated spectrum. It may be assumed that if the residual is zero—that is, if the standards can be fitted perfectly to the measured spectrum—Beer's law and the law of additivity hold for the system under study. If the

standard deviation of the residual is not zero, the theoretical model does not reflect the system under study because one of the laws is not obeyed or because an additional component is present for which there is no calibration standard. In practice, however, the residual is never zero, and the acceptable value for an analysis must be determined empirically using analytical results that meet the requirements for accuracy and precision.

Accuracy *Accuracy of a method is the degree of agreement between an individual test result generated by the method and the true value.*¹⁶ (See Appendix A for an explanation of the difference between accuracy and precision.)

To determine which wavelength or wavelengths give the best accuracy, the spectra of a set of standards are measured and calibration curves constructed at all wavelengths, as described above. A sample of known concentration is then required. This sample is ideally one for which the concentration of the analyte has been determined using a different technique. However, if such a sample is not available, a synthetic sample containing a known weight of the sample is prepared. The spectrum of the sample is measured, and quantification is performed at all wavelengths over the measured wavelength range. The quantitative results at each wavelength are then compared with the known value. A graphical plot of the quantitative results versus wavelength enables quick evaluation.

Figure 59 shows the results for a yellow dye sample. Although the analytical wavelength would have been set at 414 nm using traditional methods, the wavelength or wavelengths that give the best accuracy lie in the region of 400 nm.

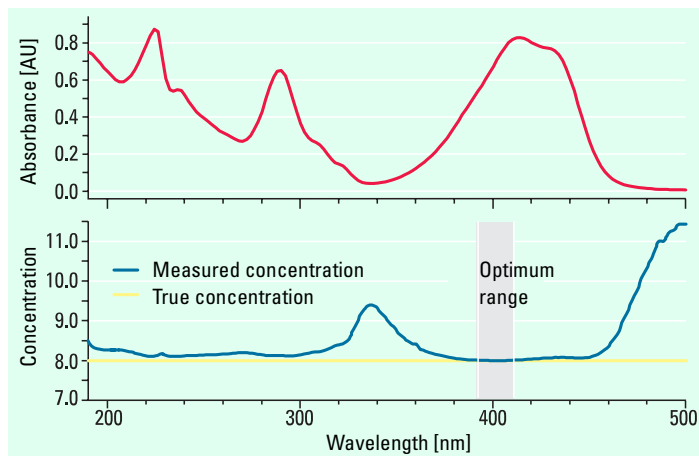

Figure 59
Selecting the wavelength(s) for best accuracy

Because noise may bias the accuracy of any individual measurement, it is preferable to perform a series of measurements on the sample and then calculate the average. This method reduces the contribution of noise to errors in accuracy.

In multicomponent analyses with spectral ranges, however, the optimum wavelength range cannot be derived using such a simple technique. Instead, the best range must be determined through trial-and-error variation of the wavelength range and through comparison of the calculated results with actual values.

Precision *Precision of a method is the degree of agreement among individual test results when the procedure is applied repeatedly to multiple samplings.*¹⁶ (See Appendix A for an explanation of the difference between accuracy and precision.)

A statistical value is required in order to determine precision. Standard deviation, percent relative standard

deviation (obtained by dividing the standard deviation by the average value and multiplying by 100), and confidence interval are the most popular tools for assessing the precision or repeatability of a set of values.

To determine the precision of a method, a set of typically 10–20 samples with the same concentration are prepared. These samples are then measured, and the amount of analyte is calculated. The standard deviation of the results is a measure of the precision. Figure 60 depicts an example of the scatter of results and the standard deviation that may be expected for a good analysis.

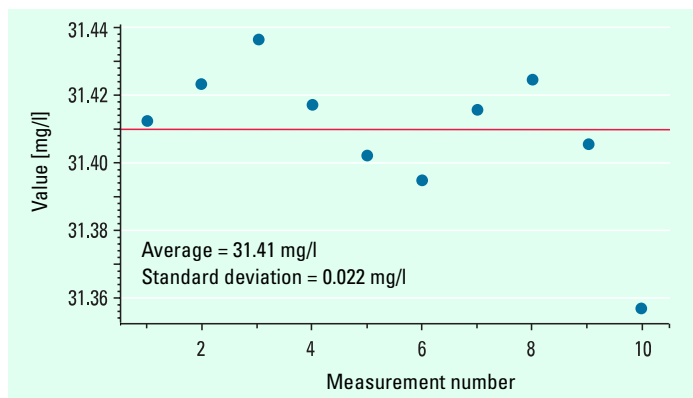

Figure 60
Determining the precision of an analysis

If the desired level of precision is not achieved, noise reduction techniques such as wavelength averaging, time averaging, and internal referencing should be used to improve the values. The same techniques can be applied in multicomponent analyses.

Sensitivity *Sensitivity refers to the response obtained for a given amount of analyte and is often denoted by two analytical factors: the limit of detection (LOD) and the limit of quantification (LOQ).*¹⁶

The LOD is the lowest concentration of analyte that can be detected but not necessarily quantified in sample matrices. In general, the LOD is the point at which the signal from the analyte is equal to three times the noise in the measurement. Measurement results from some spectrophotometers list standard deviations based on the noise in the measurement. The LOD is approximately three times the standard deviation.

The LOQ is the lowest concentration of analyte that can be determined with acceptable precision and accuracy in sample matrices. To calculate the LOQ, the acceptable limits of precision and accuracy (which depend on the objectives for the analysis) must be defined. The tools described above then can be used to determine the acceptable limits.

It is often assumed that the wavelength with maximum absorbance will give the best sensitivity. However, because instrumental noise can vary significantly with wavelength, this is not necessarily the case. A better way to determine the wavelength or wavelengths of optimum sensitivity is to measure the spectrum of a sample of low concentration several times. The average and percent relative standard deviation of the measured values at each wavelength are then calculated. The wavelength with the lowest percent relative standard deviation likely will yield the best sensitivity. Figure 61 illustrates this technique for a yellow dye sample. Although wavelengths between 400 and 450 nm give excellent sensitivity, the best sensitivity is obtained at 220 nm.

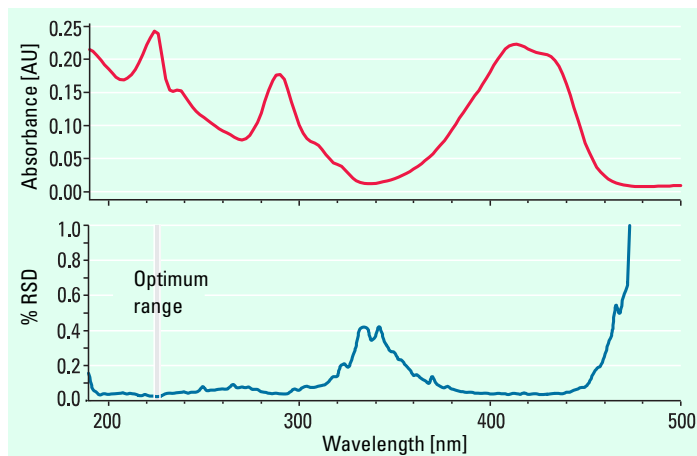

Figure 61
Selecting the wavelength or wavelengths for best sensitivity

For multicomponent analysis, this technique can be used to identify the optimum wavelength or wavelengths for each component. These wavelengths can be applied directly in the simple simultaneous equations method or as a guide for the optimum wavelength range in the least squares method.

Range *Range is the interval between (and including) the upper and lower levels of analyte that have been calculated with the required precision, accuracy, and linearity.*¹⁶

The range is determined by first analyzing samples that contain varying concentrations of the analyte and then using the tools described above to calculate the linearity, precision, and accuracy of the results.

Selectivity *Selectivity is the ability of a method to quantify accurately and specifically the analyte or analytes in the presence of other compounds.*¹⁶

The presence of any other compound that absorbs at the wavelength used to quantify the analyte will result in

quantitative error. These other compounds may be synthesis precursors, known impurities, excipients, or degradation products in the sample matrix. If the type of interferent is known, the method developer can examine the spectra of the analyte and of the interferent to select a wavelength at which the analyte has significant absorbance but the interferent has little absorbance. If the choice of wavelength does not suppress sufficiently the effect of the interferent, an appropriate correction technique such as use of an isoabsorbance wavelength (see “Isoabsorbance” on page 70) may be applied.

If the identity and/or spectra of possible interferents are unknown, an empirical approach almost identical to that described above may be used to determine which wavelength or wavelengths give the best accuracy. In this case, the test samples must contain the interferent. If the concentration of the analyte in the sample is known, the wavelength that gives the result closest to the known value yields the best selectivity. If the concentration of the analyte is unknown, the wavelength that gives the lowest concentration usually yields the best selectivity (impurities always add absorbance, causing erroneously high results).

In the example in Figure 62, the yellow dye sample has been contaminated by a red dye. The plot of concentration versus wavelength shows that wavelengths between 390 and 420 nm yield the best selectivity. Note that, owing to the contaminant, the accuracy error range is much wider than it is for pure yellow dye (see Figure 59).

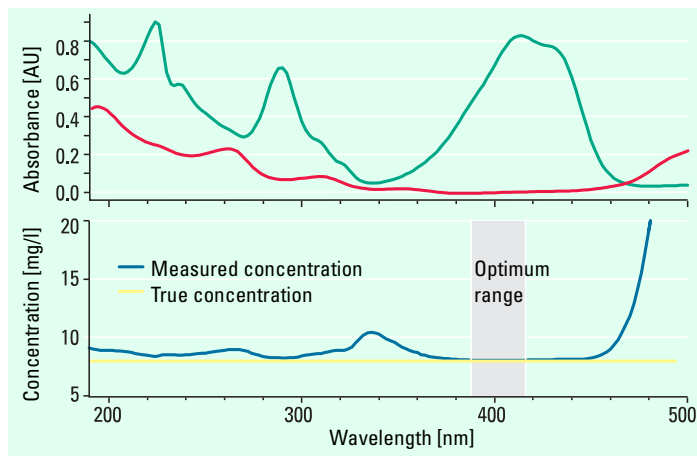

Figure 62
Selecting the wavelength or wavelengths for best selectivity

Ruggedness *Ruggedness is the degree of reproducibility of test results obtained by analyzing the same samples under a variety of normal test conditions.*¹⁶

The method should not be affected by changes in time or place. The reproducibility of the method should be established under various conditions, for example with different reagents batches, at different assay temperatures, and at different elapsed assay times.

The ruggedness of an analytical method is determined by analyzing subsamples of a homogeneous sample in different laboratories and on different instruments. These tests should be performed by different analysts under operational and environmental conditions that may vary but that fall within the specified parameters for the method. The degree of reproducibility of the results is then calculated as a function of the assay variables. This value can be compared with the precision of the method under normal conditions to obtain a measure of its ruggedness.

Instrumental requirements

In developing an analytical method, full spectral data is valuable, if not essential, for the evaluation of all possible choices. The wavelength reproducibility of the instrument also must be excellent so as not to restrict the choice of wavelength or wavelengths. A spectrophotometer that automatically measures multiple spectra and calculates average and standard deviation values for each absorbance value can greatly improve productivity as well. Finally, the instrumental software must be able to process a large amount of data and use appropriate statistical tools. Calculation by hand or the transferring of data from the spectrophotometer to other applications for evaluation seriously limits productivity.

Method validation

Any analytical method designed for use in a regulated environment, such as a pharmaceutical quality control laboratory, must be validated. Method validation is the process for determining whether performance characteristics of the method are suitable for the intended purpose.

The United States Pharmacopoeia (USP) contains specific guidelines for method validation.¹⁷ Method validation is similar to method development in that it includes studies on specificity, linearity, accuracy or recovery, sensitivity, and precision or reproducibility. However, method validation must be kept separate from method development and selection.¹⁶ Whereas method development involves the selection of specific parameters and conditions, method validation is used to confirm that the performance characteristics of the method are in keeping with the intended application in laboratory studies.

chapter 5

Routine
operation

UV-visible spectroscopy is considered a routine technique and is used extensively in QA/QC and similar laboratories. Yet neither the considerations discussed in previous chapters nor the best method development guarantees good results. This chapter reviews steps to ensure accurate and precise results on a regular basis and, perhaps more importantly, to detect erroneous results.

Instrument performance verification

In recent years, quality requirements as outlined by ISO 9000 (BS 5750), Good Laboratory Practice (GLP), Good Manufacturing Practice (GMP), and the United Kingdom National Measurement Accreditation Service (NAMAS) have assumed increasing importance. Consequently, in the pharmaceutical industry, the recommendations contained in pharmacopoeias also have become more influential. Verification of the continued proper performance of UV-visible spectrophotometers is a key element of these quality requirements.

Test parameters Although there is no clear definition as to which parameters should be tested to verify instrument performance, manufacturers and users generally agree that the criteria discussed below merit inclusion.

Wavelength accuracy and precision

Wavelength accuracy is the most important performance criterion for differentiating spectra when the spectra are measured on different instruments. It also plays a role in quantitative analysis when extinction coefficients or factors are used. Because these factors are wavelength dependent, measurements should be performed at exactly the same wavelength at which the factors were originally determined. When comparing spectra or absorbance values measured on the same instrument (as in most quantitative analyses in which a standard is measured), however, wavelength precision is the critical parameter (see “Wavelength accuracy and precision” on page 47).

To measure wavelength accuracy and precision, a reference standard is required. Ideally, this standard would have very narrow, well-defined peaks at a series of wavelengths throughout the UV and visible ranges, as shown in Figure 63. This ideal standard does not exist, although some standards approach the ideal. For actual wavelength accuracy standards, because the peaks are not ideally symmetrical, changes in the slit width of the instrument will affect slightly the measured position of the peaks.

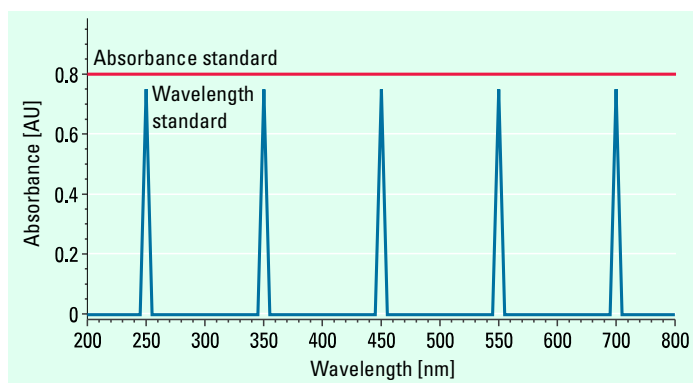

Figure 63
Ideal spectra of absorbance and wavelength standards

Photometric accuracy and precision

Photometric accuracy is the most important criterion for quantitative analysis when extinction coefficients or factors are used. For comparative measurements (as above), however, photometric precision is the critical parameter (see “Photometric accuracy and precision” on page 49).

A reference standard is necessary in order to measure photometric accuracy and precision. Ideally, this standard would have constant absorbance at all wavelengths throughout the UV and visible ranges (see Figure 63) so that any errors in wavelength accuracy do not affect results. In practice, no such standard exists, although neutral density glass approaches the ideal in the visible wavelength range. Standards used typically have broad peaks and valleys.

Stray light

Stray light is the factor that affects most strongly the linear relationship between absorbance and concentration at high absorbances. It introduces a systematic bias to lower absorbances at increasing concentrations. Stray light is also the primary influence on the upper limit of the linear dynamic range for an analysis (see “Stray light” on page 49).

To measure stray light, a filter is needed. Ideally, this filter would absorb all light of the wavelength at which the measurement is to be performed and transmit higher and lower wavelengths (the sources of the stray light, as shown in Figure 64). In practice, however, such a filter does not exist. Instead, cut-off filters that transmit all light above or below a certain wavelength and that block all light in the wavelength range are used.

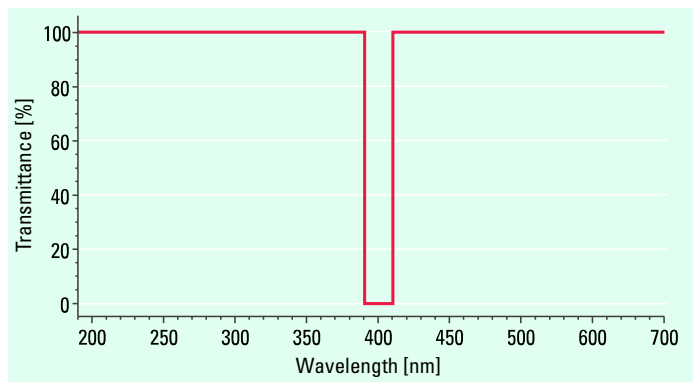

Figure 64
Ideal spectrum of a stray light filter

Resolution Resolution is a critical factor in determining the shape of measured peaks. In general, the instrumental resolution should be approximately 10 times better than the bandwidth of the peak measured. If the instrumental resolution is not sufficient, the absorbance measured at the wavelength maximum will be too low. Thus photometric accuracy has a systematic bias. This bias plays a key role if absolute accuracy is essential but, as discussed in “Spectral resolution” on page 44, it is less important for relative measurements such as quantification.

Measuring resolution is difficult, and empirical approaches, such as measuring the relative heights of peaks and valleys for a sample with a narrow band, are often used (see “Resolution” on page 118).

Noise Noise is the major factor affecting the precision of absorbance measurements. It is especially significant at low absorbances, at which it is used to determine the detection limit (see “Noise” on page 50).

Noise typically is measured at zero absorbance, that is, with no sample in the light path.

- Baseline flatness** To measure noise at all wavelengths usually is not practicable. However, baseline flatness indicates relative noise at all wavelengths and reveals wavelengths with instrumental problems resulting from the switching of filters or source exchange, for example.
- Baseline flatness typically is measured at zero absorbance.
- Stability** Stability affects the accuracy of absorbance measurements as a function of time. Drift in absorbance measurements introduces systematic errors in photometric accuracy (see “Drift” on page 52).
- Stability typically is measured at zero absorbance.
- Linearity** Linearity often is considered an important parameter for performance verification. However, because linearity is strongly sample dependent, we feel it is best measured during a system suitability test, as described below.
- The main problem in performance verification is the fact that all of the above-listed parameters are wavelength dependent and, in the case of stray light, sample dependent. Because it is not practicable to perform all tests at all wavelengths, a few wavelengths representative of the intended purpose should be selected. The results of these tests should be compared with absolute performance specifications for the methods in use. Performance verification then will demonstrate effectively whether the performance characteristics have changed in a way that could affect the goodness of the analytical results.
- Compliance with the above criteria (as determined using an appropriate set of reference standards) does not guarantee that a particular analysis can be performed with the required accuracy and linearity, however. Because many parameters are sample dependent, the desired accuracy and linearity can be achieved only with an appropriate system suitability test performed on the sample itself.

Standards A detailed discussion of all standards and their relative advantages and disadvantages is beyond the scope of this primer. Several excellent publications cover these topics in depth.^{18,19} Some general comments on the relative merits of the three main types of standards follow.

Emission standards Certain emission sources, such as mercury and deuterium arc lamps, exhibit sharp lines at specific wavelengths that are ideal for wavelength accuracy and precision testing. In fact, in many modern spectrophotometers, deuterium lines at 486.0 and 656.1 nm of the built-in source are used to check and recalibrate for wavelength accuracy. However, emission sources require electrical power supplies, and if the instrument has been self-calibrated using its built-in deuterium lamp, another standard should be used for verification. Moreover, because emission sources are not typical samples, they do not test the full system.

Solid absorption standards Solid standards do not require any preparation, are easy to use and maintain, are relatively insensitive to temperature, and have good stability over time. However, with solid standards, homogeneity cannot be ensured from one standard to another or from one batch of material to another. Each standard therefore must be calibrated individually on a reference spectrophotometer. Because this process is time-consuming, solid standards tend to be expensive. Moreover, since solid standards are not absolutely stable, they must be returned for recalibration at regular intervals. Finally, these samples must be kept scrupulously clean and cannot be used for testing flow systems.

Table 5 summarizes some of the best-known solid standards, their uses, and their advantages and disadvantages.

Table 5 Some solid standards

| Standard | Use | Advantages | Disadvantages |
|-----------------------------------|----------------------|--|--|
| Holmium oxide glass | Wavelength standard | Peaks at many wavelengths from 280 to 2000 nm | Position of peaks varies from batch to batch |
| Didymium oxide glass | Wavelength standard | Peaks at many wavelengths from 400 to 1920 nm | Position of peaks varies from batch to batch No peaks below 400 nm |
| Neodymium yttrium aluminum garnet | Wavelength standard | Peaks at many wavelengths from 350 to 1000 nm | No peaks below 350 nm |
| Neutral density glass | Photometric standard | Very flat absorbance profile in visible wavelength range | Not suitable for UV range Not absolutely stable; must be recalibrated at intervals |
| Metal on quartz | Photometric standard | Very flat absorbance profile in UV and visible wavelength ranges | Frequent interreflection error problems Temperature sensitive Not very stable; must be recalibrated at intervals |

Liquid absorption standards

Liquid standards normally are absolute physical standards. In other words, if liquid standards are prepared using appropriately pure materials, they possess inherently the properties of absorptivity, peak maxima, and so on required for accuracy checks. Because calibration of the solutions is unnecessary, liquid standards can be relatively inexpensive. These standards also can be used to check flow systems. Moreover, the process of using a solution as a standard closely resembles that for a normal sample.

The main disadvantage of liquid standards is that, in general, they must be freshly prepared. This preparation is time-consuming and requires a reasonable degree of skill on the part of the operator. Some suppliers have attempted to overcome this problem by supplying standards sealed in cuvettes. However, because the cuvette itself contributes

Routine operation

some absorbance, these standards must be calibrated and recalibrated individually, which increases costs. Furthermore, because liquid standards are less stable than solid standards, they must be recalibrated more often. Prepared solutions sealed in ampoules for use with normal cuvettes are now available that are both easy to use and cost-effective.²⁰

Table 6 summarizes some of the best-known liquid standards, their uses, and their advantages and disadvantages.

Table 6 Some liquid standards

| Standard | Use | Advantages | Disadvantages |
|---|----------------------|--|---|
| Holmium oxide in perchloric acid | Wavelength standard | Peaks at many wavelengths from 240 to 650 nm | No usable peaks above 650 nm |
| Samarium oxide in perchloric acid | Wavelength standard | Peaks at many wavelengths from 300 to 500 nm | No usable peaks above 500 nm |
| Benzene (vapor) | Wavelength standard | Very narrow peaks from 230 to 260 nm | Very limited wavelength range |
| Potassium dichromate in perchloric or sulfuric acid | Photometric standard | Broad peaks at 257 and 350 nm and broad valleys at 235 and 313 nm | No absorbance in visible range Very pH sensitive and, as a powerful oxidizing agent, can be unstable |
| Mixture of cobalt and nickel salts | Photometric standard | Peaks at 302, 395, 512, and 678 nm cover both UV and visible regions | Because bands are rather narrow, wavelength accuracy can affect results |
| Sodium nitrite solution (50 g/l) | Stray light | Cuts off at ca. 390 nm Used to measure stray light at 340 nm or below | None |
| Potassium or sodium iodide solution (10 g/l) | Stray light | Cuts off at ca. 260 nm Used to measure stray light at 200 nm or below | Tendency to decompose |

Table 6 Some liquid standards

| Standard | Use | Advantages | Disadvantages |
|--------------------------------------|-------------|---|---|
| Potassium chloride solution (12 g/l) | Stray light | Cuts off at ca. 200 nm Used to measure stray light at 220 nm or below | Because the measurement is performed on the side of the cut-off slope, wavelength accuracy errors can affect the measured stray light |
| Toluene in hexane | Resolution | Easy empirical approach using peak (269 nm) and valley (266 nm) in toluene spectrum | Can only be used to determine resolution at one point in the spectrum May vary with wavelength |

Regulatory requirements

In the following section we review some of the more important regulatory requirements governing the use of UV-visible spectrophotometers.

GLP/GMP

GLP and GMP requirements for the validation of instruments can be summarized as follows:

*Documented verification that the system or subsystem performs as intended throughout representative or anticipated operating ranges.*²¹

For spectroscopy, the following guideline is given:

*Where appropriate, periodic performance checks should be carried out (for example, ... the resolution, alignment and wavelength accuracy of spectrophotometers etc.).*²²

European Pharmacopoeia

The requirements governing UV-visible spectrophotometers used for pharmaceutical analyses in Europe are contained in the European Pharmacopoeia (EP).²³ These requirements are based on—and virtually identical to—those listed in national pharmacopoeia such as the British Pharmacopoeia (BP) in Great Britain and the Deutsche Arzneimittelbuch (DAB) in Germany:

Control of wavelengths—*Verify the wavelength scale using the absorption maxima of holmium perchlorate solution, the line of a hydrogen or deuterium discharge*

lamp or the lines of a mercury vapor arc shown below. The permitted tolerance is ± 1 nm for the ultraviolet range and ± 3 nm for the visible range.

| | |
|-----------------------|--|
| <i>241.15 nm (Ho)</i> | <i>404.66 nm (Hg)</i> |
| <i>253.70 nm (Hg)</i> | <i>435.83 nm (Hg)</i> |
| <i>287.15 nm (Ho)</i> | <i>486.00 nm (Dβ)</i> |
| <i>302.25 nm (Hg)</i> | <i>486.10 nm (Hβ)</i> |
| <i>313.16 nm (Hg)</i> | <i>536.30 nm (Ho)</i> |
| <i>334.15 nm (Hg)</i> | <i>546.07 nm (Hg)</i> |
| <i>361.50 nm (Ho)</i> | <i>576.96 nm (Hg)</i> |
| <i>365.48 nm (Hg)</i> | <i>579.07 nm (Hg)</i> |

Control of absorbance—*Check the absorbance using potassium dichromate solution R at the wavelengths indicated in the following table, which gives for each wavelength the exact value of A (1 per cent, 1 cm) and the permitted limits.*

| Wavelength (nm) | A (1 per cent, 1 cm) | Maximum tolerance |
|------------------------|-----------------------------|--------------------------|
| 235 | 124.5 | 122.9 to 126.2 |
| 257 | 144.0 | 142.4 to 145.7 |
| 313 | 48.6 | 47.0 to 50.3 |
| 350 | 106.6 | 104.9 to 108.2 |

Limit of stray light—*Stray light may be detected at a given wavelength with suitable filters or solutions: for example the absorbance of a 1.2 per cent m/V solution of potassium chloride R in a 1 cm cell should be greater than 2 at 200 nm when compared with water as compensation liquid.*

Resolution power—*When prescribed in a monograph, measure the resolution of the apparatus as follows: record the spectrum of a 0.02 % V/V solution of toluene R in*

hexane R. The minimum ratio of the absorbance at the maximum at 269 nm to that at the minimum at 266 nm is stated in the monograph.

NOTE: The BP states that the ratio should “... be not less than 1.5 unless otherwise specified in the monograph.”

**United States
Pharmacopoeia**

In the United States, the regulatory requirements for UV-visible spectrophotometers are not as clearly defined as in Europe. The United States Pharmacopoeia²⁴ (USP) XII, Section 831 (“Spectrophotometry and light scattering”) states:

Check the instrument for accuracy of calibration. ... The wavelength scale may be calibrated also by means of suitable glass filters, which have useful absorption bands through the visible and ultraviolet regions. Standard glasses containing didymium (a mixture of praseodymium and neodymium) have been widely used. Glass containing holmium is considered superior.

For checking the photometric scale, a number of standard inorganic glass filters as well as standard solutions of known transmittance such as potassium chromate or potassium dichromate are available.

The latter contains a cross reference:

For further details regarding checks on both wavelength and photometric scales of a spectrophotometer, reference may be made to the following publications of the National Institute of Standards and Technology ...

The National Institute of Standards and Technology (NIST) gives a range of solid and liquid standards for determining

wavelength accuracy, photometric accuracy, and stray light.²⁵ Table 7 summarizes the most important of these.

Table 7 NIST standards

| SRM # | Type | NIST description |
|-------|--|---|
| 930 | Neutral density glass filters | <i>This SRM is for the verification and calibration of the transmittance and absorbance scales of visible absorption spectrometers.</i> |
| 931 | Cobalt and nickel solution in nitric/perchloric acid mixture | <i>The SRM is for the verification and calibration of the absorbance scales of ultraviolet and visible absorption spectrometers having narrow bandpasses.</i> |
| 935 | Potassium dichromate solid for preparation of test solution | <i>This SRM is for the verification and calibration of the absorbance scales of ultraviolet absorption spectrometers.</i> |
| 2031 | Metal on quartz | <i>This SRM is for the verification and calibration of the transmittance and absorbance scales of ultraviolet and visible absorption spectrometers.</i> |
| 2034 | Holmium oxide solution in perchloric acid | <i>This SRM is for use in the verification and calibration of the wavelength scale of ultraviolet and visible absorption spectrometers having nominal spectral bandwidths not exceeding 3 nm.</i> |
| 2032 | Potassium iodide solid for preparation of test solution | <i>This SRM is for use in the assessment of heterochromic stray radiant energy (stray light) in ultraviolet absorption spectrometers.</i> |

American Standard Testing Methods

The American Standard Testing Methods (ASTM)²⁶ publishes test methods for measuring the key performance characteristics of UV-visible spectrophotometers:

Wavelength accuracy and precision: determined using a mercury vapor discharge lamp (UV region), a deuterium or hydrogen arc lamp (visible region), benzene vapor (UV region), or holmium oxide glass or holmium perchlorate solution (UV and visible regions). The ASTM recommends that the calibration wavelengths used bracket the analytical wavelength.

Linearity: determined by preparing an analytical working curve with the target analyte (see “System suitability” on page 113).

Photometric accuracy: determined using NIST 930, 2031, or 935 standards.

Photometric precision: determined using a metallic screen or a suitable glass filter.

The importance of slit width and resolution are mentioned in ASTM documentation, but no practical method for measuring these parameters is given. An additional ASTM publication²⁷ describes standards and procedures for measuring stray light.

Table 8 summarizes the requirements and recommendations of the various regulatory bodies.

Table 8 Test parameters and standards used by the main regulatory agencies

| Test type | Standard | NIST | | EP | ASTM |
|------------------------------------|----------------------------------|----------|------|----------|----------|
| | | USP | SRM | | |
| Wavelength accuracy | Holmium perchlorate solution | — | 2034 | S | X |
| | holmium oxide glass | X | — | — | X |
| | Deuterium arc lamp | X | — | S | X |
| | Mercury arc lamp | X | — | S | X |
| | Benzene vapor | — | — | — | X |
| Photometric accuracy and linearity | Potassium dichromate solution | X | 935 | S | X |
| | Neutral density glass | — | 930 | — | X |
| | Cobalt and nickel salts solution | — | 931 | — | X |
| | Metal on quartz | — | 2031 | — | X |
| Stray light | Potassium chloride solution | — | — | S | X |
| | Potassium iodide solution | — | 2032 | — | — |
| | Sodium iodide solution | — | — | — | X |
| | Sodium nitrite solution | — | — | — | X |
| Resolution | Toluene in hexane solution | — | — | S | — |

USP: Test method only

NIST SRM: Standard material and test method

EP: Test method and minimum performance specification

ASTM: Test method only

The choice of standards depends on the analyses to be performed on the instrument. This condition is highlighted by GLP requirements that verification should be performed for the intended and anticipated operating ranges, by ASTM recommendations that wavelengths used for calibration bracket the analytical wavelength, and by NIST regulations. Thus, for example, if the intended purpose is to measure absorbance in the UV region (as in most pharmaceutical analyses), photometric accuracy should be verified not in the visible range but in the UV range, preferably at several wavelengths. Similarly, it is not appropriate to verify wavelength accuracy only at the 656.1-nm deuterium line since this is not a reliable indicator of wavelength accuracy in the UV region.

Recommendations Although there is no definite set of standards for verifying the performance of a spectrophotometer, the following tests are recommended for those users who analyze primarily liquid samples and who need to comply with general regulatory requirements.

Wavelength accuracy: holmium perchlorate solution (40 g/l holmium oxide in 10 % v/v perchloric acid). Figure 65 shows the spectrum of this solution as measured on an Agilent 8453 spectrophotometer.

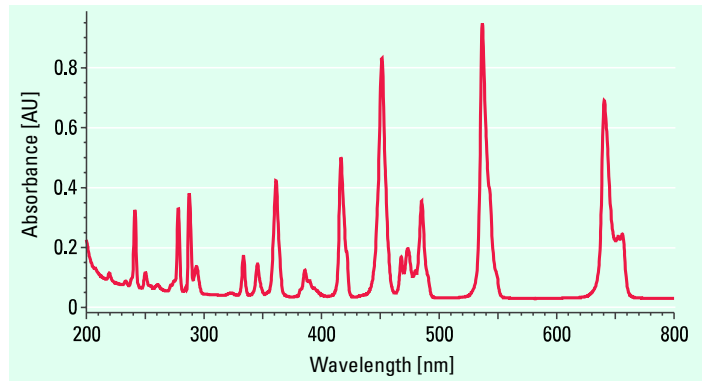

Figure 65
Spectrum of holmium perchlorate solution

Table 9 shows the values specified by NIST for the usable reference peaks for three different instrumental spectral bandwidths (SBWs). These values are preferable to EP values because the EP does not specify the SBW or

temperature used and because the EP and NIST values exhibit significant discrepancy.

Table 9 NIST values for holmium perchlorate solution peaks²⁸

| SBW | | |
|---------------|---------------|---------------|
| 0.5 nm | 1.0 nm | 2.0 nm |
| 241.01 | 241.08 | 240.90 |
| 249.79 | 249.87 | 249.98 |
| 278.13 | 278.10 | 278.03 |
| 287.01 | 287.18 | 287.47 |
| 333.43 | 333.44 | 333.40 |
| 345.52 | 345.47 | 345.49 |
| 361.33 | 361.31 | 361.16 |
| 385.50 | 385.66 | 385.86 |
| 416.09 | 416.28 | 416.62 |
| — | 451.30 | 451.30 |
| 467.80 | 467.83 | 467.94 |
| 485.27 | 485.29 | 485.33 |
| 536.54 | 536.64 | 536.97 |
| 640.49 | 640.52 | 640.48 |

Photometric accuracy: potassium dichromate solution (approximately 60 mg/l in 0.01N sulfuric acid). Figure 66 shows the spectrum of potassium dichromate. The EP values for this standard are given on page 112.

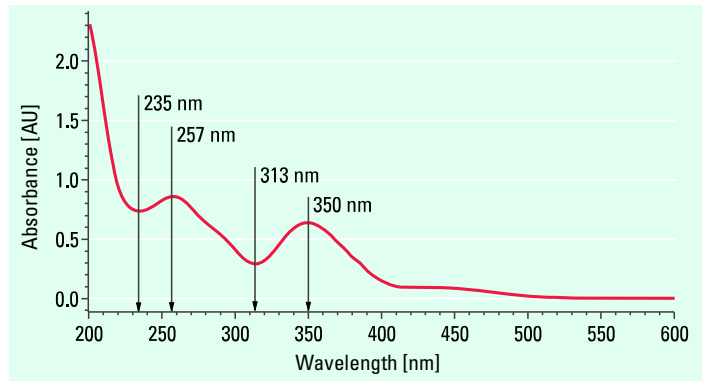

Figure 66
Spectrum of potassium dichromate

If measurements are to be performed in the visible region, additional testing with neutral density glass filters such as the NIST SRM 930 is advisable.

Stray light: solutions of sodium nitrite (50 g/l), sodium iodide (10 g/l), and potassium chloride (12 g/l) in water. These three solutions enable the measurement of stray light at three different wavelengths. Figure 67 shows the spectra of these solutions. In general, sodium nitrite and sodium or potassium iodide is recommended but, for those users who need to comply with EP requirements, potassium chloride also may be necessary.

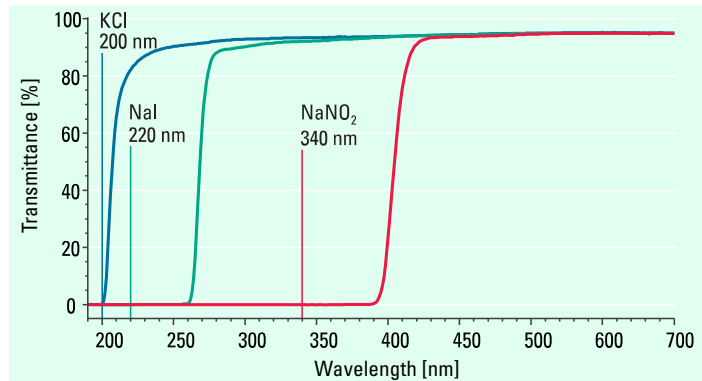

Figure 67
Spectra of stray light standard solutions

Resolution: solution of toluene in hexane (0.02 % v/v), as specified in the EP. Figure 68 depicts the spectrum of this solution.

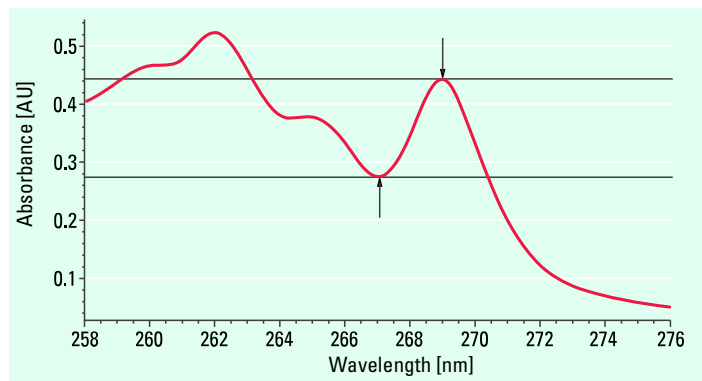

Figure 68
Spectrum of toluene in hexane

The resolution is estimated by taking the ratio of the absorbance of the maximum near 269 nm to that of the

minimum near 266 nm. This ratio is empirically related to the SBW, as shown in Table 10.²⁹

Table 10 SBW and 269/266 nm ratio (toluene)

| SBW (nm) | Ratio of absorbance at 269 nm to absorbance at 266 nm |
|----------|---|
| 0.25 | 2.30 |
| 0.50 | 2.20 |
| 1.00 | 2.00 |
| 2.00 | 1.40 |
| 3.00 | 1.10 |
| 4.00 | 1.00 |

Noise, baseline flatness, and drift also should be measured with a clear sample area. No standard is required.

Instrument self-test

Full performance verification of a spectrophotometer is time-consuming and thus normally done only at periodic intervals. These intervals are determined according to the stability of the instrument. To ensure that any deviations from performance occurring between verifications are detected in a timely fashion, the instrument should be equipped with self-test routines that can be run on a daily basis. These routines should include a check of the electronic and optical operation of the spectrophotometer as well as wavelength accuracy checks with one or both lines from the deuterium lamp.

System suitability

System suitability is designed to evaluate the components of the analytical system in order to verify that system performance meets the standards required by the method. System suitability should not be confused with method validation. Whereas method validation is performed once at the end of method development, system suitability tests are performed on a given system periodically to determine its adequacy or effectiveness. System suitability requirements are well-defined for chromatography systems but not for UV-visible spectroscopy systems.

In practice, analysts have developed their own strategies for performing system suitability tests on UV-visible instruments. Two examples follow:

A. Measure and calibrate using one standard with a concentration equal to 100 % of the expected component concentration. Then measure and quantify the standard and the standard diluted by a factor of two. The results of both samples should fall within a specified percentage of the known concentration. Remeasuring the standard confirms the accuracy of the initial measurement.

B. Measure first the standard and then a series of dilutions of the standard and calculate the extinction coefficient (absorbance divided by concentration) for each concentration. The values of the extinction coefficients should not vary by more than a specified percentage.

Proper operation

However good quality control measures such as instrument performance verification tests and method validation, accurate and precise results remain highly dependent on the human factor. Although this factor can never be eliminated, steps nonetheless can be taken to reduce human error.

Electronic storage Modern spectrophotometers are almost invariably microprocessor or computer controlled and should provide for electronic storage of method parameters. Ideally, all relevant parameters should be stored in a single method file under a unique name. When the operator enters the name of the method, all parameters should set automatically, thus eliminating potential error. Regulated environments in particular would benefit from a system that prevents operators from changing method parameters or that keeps track of and reports any method changes.

Standard operating procedures Although spectrophotometers can store and automatically set most method parameters, some procedures—for example, emptying, rinsing, and filling cuvettes with samples—must be performed by the operator and can introduce substantial errors. Operators should be properly trained in these procedures, and all steps should be clearly documented in working instructions. In a regulated environment, these steps are known as standard operating procedures (SOPs).

Collateral data

Errors or entirely incorrect results can occur despite the best instrumentation, method development and validation, and operator training. For example, the sample may be contaminated. Whereas an incorrect result in itself is not necessarily problematic, failing to recognize that a result is incorrect can have serious consequences. Most analytical results obtained with UV-visible spectroscopy are based on a single measurement at a single wavelength. With a single data point, however, there is virtually no way to detect whether a result is suspect unless a typical result is known and the actual result deviates significantly from the known value. Collateral data and multiple measurements at a single wavelength or (preferably) at multiple wavelengths can help ensure that a result is correct. The data also can be used to investigate the reason for an incorrect result.

Confirmation wavelengths

A simple way to verify quantitative analytical results is through confirmation analysis. In confirmation analysis, the absorbance at one or more wavelengths in addition to the analytical wavelength is measured both on standards and on unknown samples. Quantification is performed at all measured wavelengths. If the sample is pure, the results at the analytical wavelength and at the confirmation wavelength or wavelengths will be identical. If the sample is contaminated, it is highly probable that the contaminant will contribute a different absorbance value at the analytical and confirmation wavelength or wavelengths, and results will differ. An example is shown in Figure 69. Confirmation analysis also can be used to detect whether the correct sample has been measured and whether measurements lie outside the linear dynamic range of the instrument.

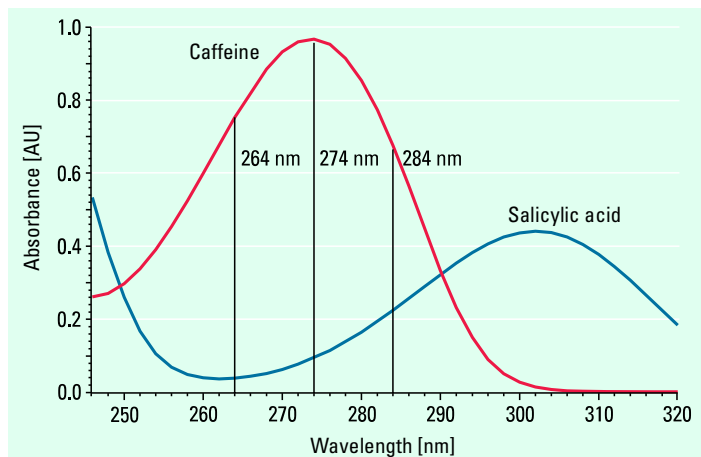

Figure 69
Confirmation analysis

Full spectra

For optimum results, the full spectra of the sample for analysis should be acquired. The sample spectra can be overlaid onto the standard spectra to check for any differences, or mathematical methods can be used to obtain

a match factor, which indicates the similarity of samples to standards. The match factor is obtained by plotting the absorbance values at each wavelength of the sample against the standard. If the spectra are identical, the plotted points will fall on a straight line. The slope of this line is the ratio of the concentration of the sample to the standard. If the spectra are not identical, the points will not fall on a straight line but exhibit scatter. Figure 70 shows plots of both similar and dissimilar spectra. In both cases, linear regression can be used to fit the best straight line, and the correlation coefficient can be calculated. The correlation coefficient is a measure of the similarity of the sample spectra to the standard spectra. If spectra are perfectly similar, the correlation coefficient will be 1, whereas for completely dissimilar spectra, it will be close to 0.

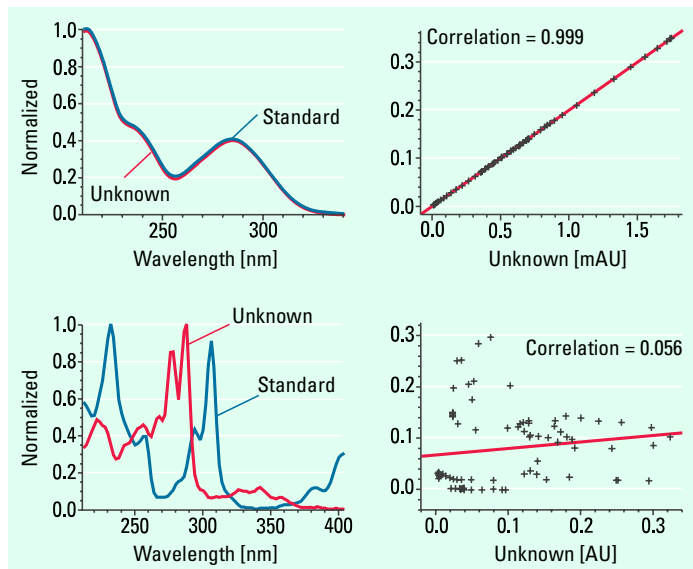

Figure 70
Comparative plots of similar and dissimilar spectra

If full spectra are used, all analytical information is available for reevaluation of results and for determining why a result was incorrect.

Statistics A single measurement does not have a high degree of validity. All measurements include some degree of bias and random variation due to noise. Although bias can be detected using techniques such as those described above, noise also can result in significant errors. The precision of results always should be estimated by performing multiple measurements and then calculating the average and the standard deviation of the average. The standard deviation is an indicator of the validity of a measurement. Monitoring of changes in the standard deviation of results over time can be a useful diagnostic for many measurement problems.

Appendix A

Definition of terms

The terms accuracy and precision are used throughout this primer, but not interchangeably. It is therefore important to clearly understand the difference between them. As an analogy, Figure 71 shows the performance of a marksman on a rifle range.

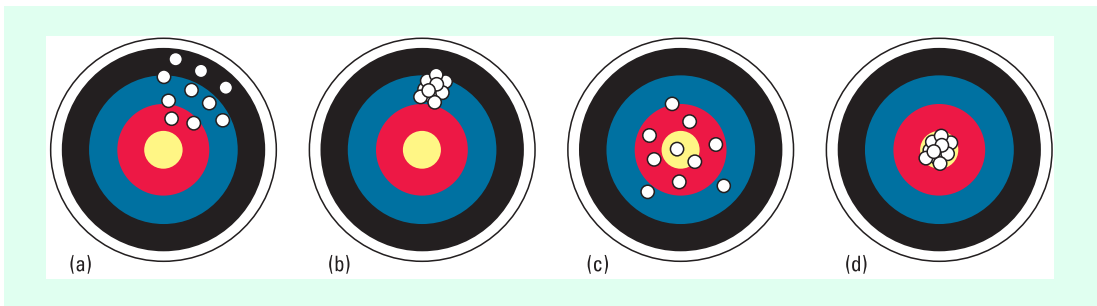

Figure 71
Example of precision and accuracy

In (a), the shots are neither accurate nor precise. In (b), the shots are precise but inaccurate; the marksman is performing well, but a consistent bias is evident. In (c), the shots are accurate but imprecise: the average of the shots would lie in the center of the target, but the individual shots deviate significantly. In (d), the shots are both accurate and precise.

Appendix B

Characteristics of diode array spectrophotometers

Advantages of diode array spectroscopy

As the leading manufacturer of diode array spectrophotometers, we feel this technology offers considerable advantages over conventional scanning spectrophotometers. In the following sections we review the advantages of diode array technology and comment on some of the real or perceived disadvantages.

Fast spectral acquisition

Fast spectral acquisition makes diode array spectrophotometers the first choice for measurement of dynamic systems such as flow injection analysis detection, process control, and kinetic measurements. For example, Figure 72 shows spectra measured at intervals of 1 s during a hydrolysis reaction of sultone. With this data, the disappearance of the reactant and the appearance of the product can be monitored simultaneously.

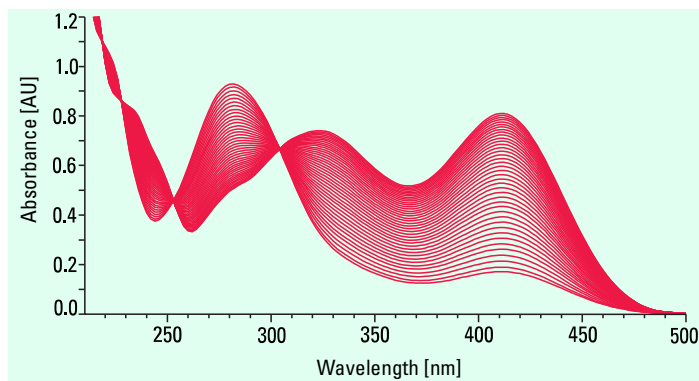

Figure 72
Spectra of hydrolysis of sultone

For most UV-visible spectrophotometer users who are not performing measurements on dynamic systems, fast full spectral acquisition still offers significant advantages. Because it is so fast, this method enables the acquisition of full spectra even when the analysis requires only a single

wavelength. The full spectral data can be used for error correction (see “Background modeling” on page 71 and “Derivative spectroscopy” on page 73) and as collateral data for confirming data quality (“Full spectra” on page 115).

Finally, full spectra can be obtained with high productivity for use in method development (see “Method development” on page 80) and for multicomponent analysis (see “Multicomponent analysis” on page 21).

Simultaneous multiwavelength measurement

Most conventional spectrophotometers can perform multiwavelength measurements but must physically move from one point in the spectrum to another to do so, which takes time. With a diode array spectrophotometer, all points in the spectrum can be measured simultaneously. Multiple wavelength measurements thus are completed in the time a conventional instrument requires to perform a single wavelength measurement. This technique facilitates the use of various techniques for eliminating errors (see “Isoabsorbance” on page 70, “Internal referencing” on page 72, and “Three-point correction” on page 72). Moreover, it provides collateral data for confirming data quality (see “Confirmation wavelengths” on page 115) and enhances productivity when the simple simultaneous equations method is used (see “Multicomponent analysis” on page 21). With multiwavelength measurement, smaller quantities of data need to be stored than with full spectral measurement. However, error-eliminating techniques are somewhat less effective than those that can be used with full spectra.

Through the use of alternative wavelengths for high and low concentration ranges, dynamic range can be maximized with diode array spectrophotometers. The absorption maxima can be used for high-sensitivity measurements, and a wavelength with lower absorption on the side of the absorption band prevents errors due to stray light.

Finally, a diode array spectrophotometer can be used in many applications where an expensive dual-wavelength

spectrophotometer (see “Dual-wavelength design” on page 43) was previously required.

**Wavelength
resettability**

Conventional mechanical scanning spectrophotometers have an inherent wavelength resettability error (see “Wavelength accuracy and precision” on page 47) that increases with time as mechanical linkages wear down. They are also susceptible to wavelength drift over long periods of time. Because in diode array instruments no parts are moved to change wavelength or to scan, no significant mechanical error or drift with time occurs.

Data from all parts of the spectrum, unaffected by wavelength resettability errors, is of benefit to the analyst. It allows selection of the optimum wavelength for improved dynamic range, sensitivity, and selectivity in method development (see “Method development” on page 80). Moreover, it is essential in techniques to improve sensitivity using wavelength averaging (see “Wavelength averaging” on page 65), to decrease sensitivity for strongly absorbing compounds (see “Strong absorbance” on page 66), and to confirm data quality with confirmation wavelengths (see “Confirmation wavelengths” on page 115). Other techniques that use full spectral data include multicomponent analysis (see “Multicomponent analysis” on page 70), method development (see “Method development” on page 80), confirmation of data quality (see “Confirmation wavelengths” on page 115), and derivative spectroscopy (see “Derivative spectra” on page 6 and “Derivative spectroscopy” on page 73).

Excellent wavelength resettability also ensures that any differences in measurements result from the sample and not from instrument resettability errors. Positive identification of compounds is thus possible even when the spectra are virtually identical but exhibit a small wavelength shift.

Moreover, the spectra of standards can be measured, stored on disk, and recalled days, weeks, or even months later for use in quantitative analysis without remeasuring the

standards. This method improves productivity, especially in the case of expensive, difficult-to-obtain, or unstable compounds that cannot be used routinely in the laboratory.

Sensitivity The dynamic range of a diode array spectrophotometer can be extended further at low absorption levels. Diode array instruments typically are less complex and have fewer optical surfaces than conventional ones. As a result, light throughput is higher and noise levels are lower.

The ability to acquire full spectra quickly also can help improve spectral sensitivity using time averaging (see “Time averaging” on page 65) and wavelength averaging (see “Wavelength averaging” on page 65) techniques.

Measurement statistics Diode array spectrophotometers scan so quickly that multiple measurements normally are performed and averaged together. Both the average and standard deviation for each data point are calculated. The standard deviation is a measure of the reliability of the data point and is obtained for every absorbance value in the spectrum. It has been said that no statistical significance can be attached to a single measurement.¹² With conventional spectrophotometers, however, obtaining multiple measurements is too time-consuming.

The statistical data is a valuable diagnostic tool for evaluating the quality of the analysis results (see “Statistics” on page 117) and also should be used during method development (the software that comes with Agilent spectrophotometers automatically makes use of such data).

Ruggedness and reliability Diode array spectrophotometers are mechanically simple in that they have almost no moving parts. Because few pieces will wear out or break, these instruments are highly reliable. The user benefits from minimal down-time. In addition, cost of ownership is lower than with conventional instruments because diode array spectrophotometers do not require regular maintenance or recalibration. Modern diode array

spectrophotometers are estimated to have only one failure in 10 years (excluding lamp changes).

Open sample area Owing to the reversed optics design of the instrument (see “The diode array spectrophotometer” on page 37), the sample area of a diode array spectrophotometer does not need to be covered because the instrument is not susceptible to interference from ambient light. Moreover, this design increases productivity by facilitating the exchange of samples, and a wider range of sample types can be measured because size restrictions are fewer. Changing or adding specialized sampling accessories is also easier.

Disadvantages of diode array spectroscopy

Because diode array spectrophotometers differ from conventional scanning spectrophotometers, many objections have been raised concerning their performance. In this section we address briefly these objections.

Resolution With a conventional scanning spectrophotometer, resolution can be changed easily by varying the slit width. With a diode array spectrophotometer, however, resolution depends on an additional factor: the sampling interval of the diode array. The sampling interval in turn depends on the number of diodes in the array and on the wavelength range measured. Until recently, diode array instruments had some resolution limitations compared with 2-nm resolution instruments. This problem has been corrected in modern diode arrays, such as the Agilent 8453 (see “Dual-beam design” on page 40), which contain more elements. Although diode array instruments cannot achieve resolutions of 0.5 nm or less as can some conventional instruments, such high resolution may not be necessary in many analyses (see “Spectral resolution” on page 44). Moreover, with higher resolution, less light reaches the detector and sensitivity is lower. For example, if a spectrum

is scanned with a resolution of 0.1 nm, it can take as much as an hour or more to obtain a spectrum with good S/N.

Stray light In a sequentially scanning instrument, stray light is reduced by moving filters into the light path in front of the monochromator (see “Stray light” on page 49). These filters must be changed in accordance with the wavelength of the incident light. With a diode array spectrophotometer, using filters in this way usually limits the range of wavelengths that can be measured simultaneously for a spectrum. Instead, filters are placed over the array itself to reduce stray light. However, because all wavelengths of light are always in the detector area, stray light is more problematic than it is with conventional spectrophotometers.

Until recently, diode array spectrophotometers exhibited higher levels of stray light than conventional instruments. However, the Agilent 8453 is based on a patented process that uses the fast full spectrum scanning capability of diode array technology to reduce significantly stray light. First, the full spectrum is scanned. A filter that blocks all light below 430 nm is then dropped into the light path, and the spectrum in the region up to 430 nm is measured. The only light detected is stray light, which is then subtracted from the first measurement to yield a stray light corrected spectrum. The entire process takes only 1.5 s (with two 0.5-s measurements) and reduces stray light to levels equivalent to or better than those obtained with comparable single monochromator conventional scanning instruments.

Sample decomposition Because a diode array spectrophotometer irradiates the sample with all wavelengths of light, it has been argued that the sample will be degraded. However, the intensities of light used with a diode array spectrophotometer are no higher than with a conventional instrument. Thus, when a full spectrum is scanned sequentially with a conventional spectrophotometer, the total amount of light (the sum of all light at each wavelength) to which the sample is subjected

is the same as with a diode array spectrophotometer. If the sample is photosensitive, both instruments will decompose it to the same extent. Some circumstantial evidence indicates that a diode array instrument in some cases can acquire spectra of highly photosensitive compounds that cannot be obtained with a conventional instrument.

When measuring a single wavelength, a conventional instrument should have a clear advantage over a diode array spectrophotometer since it subjects the sample to much less irradiation. In practice, however, problems of photodegradation are extremely rare. At the time of writing, we are not aware of any documented cases.

Complexity Some users are intimidated by diode array instruments because they believe them to be too complicated. Yet although the internal data processing associated with diode array spectrophotometers is indeed far more complex than that of conventional instruments, the user is never made aware of the difference. And, whereas diode array spectrophotometers generate much more data than conventional instruments, this data is easily managed with modern software. Moreover, the additional data creates numerous advantages, as discussed throughout this primer.

Errors in measuring fluorescent samples Although diode array spectrophotometers can produce incorrect results when measuring fluorescent samples, conventional scanning instruments are subject to error as well (see “Fluorescence” on page 77 for an explanation).

References

1. Savitzky, A.; Golay, M. *Anal. Chem.*, **1964**, 36, 1627–1639.
2. Macadam, D.L. *Colour Measurement*, Springer: Berlin, **1981**.
3. Chamberlain, G.J.; Chamberlain, D.G. *Colour; its measurement, computation and application*, Heyden: London, **1980**.
4. Levine, R.L.; Federici, M.M. “Quantification of aromatic residues in proteins; model compounds for second derivative spectroscopy”; *Biochemistry*, **1982**, 21, 2600–2606.
5. Kisner, H.J.; Brown, W.B.; Kavarnos, G.J. “Multiple analytical frequencies and standards for the least-squares analysis of serum lipids”; *Anal. Chem.* **1983**, 55, 1703.
6. Maris M.A.; Brown, C.W.; Lavery, D.S. “Nonlinear multicomponent analysis by infrared spectrophotometry”; *Anal. Chem.*, **1983**, 55, 1694.
7. Zwart, A.B.; van Kampen, E.J.; Zijlstra, W.G. “Multicomponent analysis of hemoglobin derivatives with a reversed-optics instrument”; *Clin. Chem.*, **1984**, 30, 373.
8. *Practical Absorption Spectrometry, Techniques in Visible and Ultraviolet Spectrometry: Volume 3*, Burgess, C.; Knowles, A., Eds.; Chapman and Hall: London, **1984**.
9. Strong III, F.C. “Correlation of measurements of absorbance in the ultraviolet and visible regions at different slit widths”; *Anal. Chem.*, **1976**, 48, 2155.
10. Johnson, T.J. *Int. Lab.*, **1982**, 12(7), 42, 44–45.
11. *Hellma Catalogue*, Hellma: Müllheim/Baden, **1994**.
12. Sharaf, M.A.; Ilman, D.L.; Kowalski, B.R. *Chemometrics, Chemical Analysis, Vol. 82*, Wiley: New York, **1986**, 82.

13. Miller, J.C.; Miller, J.N. *Statistics for Analytical Chemistry*, 2nd ed., Harwood: Chichester, **1988**.
14. Mark, H. *Principles and Practice of Spectroscopic Calibration, Chemical Analysis, Vol. 118*, Wiley: New York, **1991**.
15. *Understanding Your Advanced UV-visible Software*, Agilent Technologies, part number G1116-90003, **2000**.
16. Paul, W.L. "USP perspectives on analytical methods validation"; *Pharm. Technol.*, **1991**, 15(3), 130–141.
17. *Validation of Compendial Methods, United States Pharmacopoeia XXII, National Formulary, XVII*, The United States Pharmacopoeial Convention, Inc., Rockville, MD. 1710–1712, **1990**; General Chapter <1225>.
18. *Standards in Absorption Spectrometry, Techniques in Visible and Ultraviolet Spectrometry: Volume 1*; Burgess, C.; Knowles, A., Eds.; Chapman & Hall: London, **1981**.
19. Nowicka-Jankowska, T.; Gorczynska, A.; Michalik, A.; Wieteska, E. *Comprehensive Analytical Chemistry, Volume XIX, Analytical Visible and Ultraviolet Spectrometry*; Elsevier: Amsterdam, **1986**.
20. *Operational Qualification and Performance Verification of UV-Visible Spectrophotometers*, Agilent Technologies, publication number 5965-7438E, **2000**.
21. Alford, J.S.; Cline, F.L. "PMA's computer system validation committee, computer system validation—staying current: installation qualification"; *Pharm. Technol.*, **1990**, 14, 88–104.
22. *EURACHEM Guidance Document No. 1/WELAC Guidance Document No. WGD 2: Accreditation for chemical laboratories: Guidance on the interpretation of the EN 45000 series of standards and ISO/IEC Guide 25*, **1993**.

23. European Pharmacopoeia, 3rd ed., **1996**, Strasbourg, France.
24. *Spectrophotometry and Light Scattering, United States Pharmacopoeia XXII, National Formulary, XVII*, The United States Pharmacopoeial Convention, Inc., Rockville, MD, **1990**, 1609–1614, General Chapter <851>.
25. *Standard Reference Materials Catalog*, National Institute of Standards and Technology: Gaithersburg, MD, **1995**, 104–106.
26. *Standard Practice for Describing and Measuring Performance of Ultraviolet, Visible, and Near-Infrared Spectrophotometers*, ASTM Standard E 275-83, **1994**.
27. *Standard Test Method for Estimating Stray Radiant Power Ratio of Spectrophotometers by the Opaque Filter Method*, ASTM Standard E-387, **1990**.
28. SRM 2034 Certificate, National Institute of Standards and Technology: Gaithersburg, MD, **1992**.
29. *Pharmeuropa, Special Edition, Technical Guide*, Council of Europe: Strasbourg, **1993**.

Index

A

absorbance, 3, **6**, 21, 81, 103
 and color, 13
 bands, 7, 11, 74, 75
 interfering, 67, 68, 72
 measurement errors in, 51–52, 58–59, 63, 77
 strong, **66–67**, 124
 weak, **64–66**
 acceptance angle, 78
 accuracy, **85–86**, 98
 photometric, **49–52**, **96**, 97, 98, 105, 106, 109
 wavelength, **47–49**, **95**, 99, 101, 105, 106
 additivity, **21**, 84
 Agilent 8453 spectrophotometer, 39, 40
 amino acids, 14
 apertured cells, 58, 59
 ASTM (American Standard Testing Methods), **105–107**

B

background modeling, **71**
 balance measurement, 44
 baseline flatness, **98**, 112
 Beer's law, **16–20**, 21, 81
 Beer–Bouguer–Lambert law, 18–19
 benzene (vapor), 101, 105, 106
 blank, 36, 39, 40, 42, 44, 62, 63
 Bouguer–Lambert law, 17
 British Pharmacopoeia (BP), 102, 104

C

calibration curve, 19, 81–83
 cell types, **57–58**
 apertured, 58, 59
 flow through, 58
 microcells, 58
 open-topped rectangular, 57
 ultramicrocells, 58
 unmasked, 59
 cells, **56–59**

care of, **59**
 material, **56–57**
 chemical derivatization, **27**
 chromatic aberration, 36
 chromophore, 10–11, 60
 cobalt salts, 101, 106
 in nitric/perchloric acid, 105
 collateral data, **114–117**, 123
 color, **13–14**
 concave mirrors, 36
 confidence interval, 87
 confirmation wavelength, 115, 124
 conventional spectrophotometer, **36–37**
 correction techniques, **69–76**, 90, 123
 background modeling, **71**
 derivative spectroscopy, **73–76**
 internal referencing, 39, 53, 62, **72**, 87
 isoabsorbance, **70**, 90
 multicomponent analysis, 14, **21–26**, **70**, 123, 124
 three-point correction, **72**
 correlation coefficient, 82, 83, 84, 116

D

derivative spectra, **6–10**, 11–12, 20
 derivative spectroscopy, **73–76**
 detector
 diode array, 34–35
 photodiode, 33–34
 photomultiplier tube, 33
 deuterium arc lamp, 31, 99, 105, 106
 Deutsche Arzneimittellbuch (DAB), 102
 didymium oxide glass, 100
 diode array detector, 34–35
 diode array spectrophotometer, **37–38**
 dispersion devices, **32–33**
 DNA (deoxyribonucleic acid), 14–15
 drift, 40, 42, **52**, 66, 98, 112, 124
 dual-beam spectrophotometer, **40–41**
 dual-wavelength spectrophotometer, **43**

E

electromagnetic radiation, 3, 30
 spectrum, 2
 electronic energy, 4
 emission standards, **99**
 energy
 electronic, 4
 rotational, 4
 vibrational, 4
 enzyme activity, **15–16**, 28
 enzyme kinetic assays, **28**
 European Pharmacopoeia (EP), **102–104**, 106, 108, 111
 extinction coefficient, 18–19, 20, 21, 95, 96, 113

F

filters, 33, 78, 96
 neutral density glass, 105, 110
 flow-through cells, 58
 fluorescence, 3, **77–78**
 forward optics, 77
 frequency, **3**

G

GLP (Good Laboratory Practice), 94, **102**, 107
 GMP (Good Manufacturing Practice), 94, **102**
 Golay. *See* Savitzky–Golay
 polynomial technique

H

holmium oxide, 107
 glass, 100, 105, 106
 in perchloric acid, 101, 105
 holmium perchlorate solution, 105, 106, 107, 109
 holographic gratings, 32–33
 HP 8450A spectrophotometer, 41, 42

HP 8453 spectrophotometer, 107, 127
 hydrolysis reaction
 of sultone, 122

I

identification, **10–11**, 12, 16
 instrumental spectral bandwidth (SBW), 45–47, 108, 109, 112
 interference, 9, 20, 28
 types of, **67–76**
 internal referencing, 39, 53, 62, **72**, 87
 ISO 9000, 94
 isoabsorbance, **70**, 90
 and multicomponent analysis, **70**

L

Lambert. *See* Bouguer-Lambert law
 lamp
 deuterium arc, 31, 99, 105, 106
 mercury arc, 99, 106
 mercury vapor discharge, 105
 tungsten-halogen, 31
 xenon, 32
 least squares method, 9, **24–25**, 26, 27, 82, 89
 lenses, 36
 light sources, **31–32**
 limit of detection (LOD), 87–88
 limit of quantification (LOQ), 87–88
 linear dynamic range, **51–52**, 56, 66, 123, 124
 linearity, **81–85**, **98**, 98, 105, 106

M

matrix, 9, 62, 68, 76
 mercury arc lamp, 99, 106
 mercury vapor discharge lamp, 105
 metal on quartz, 100, 105, 106
 method development, **80–92**, 123
 method validation, **92**
 microcells, 58

monochromator, 33
 Morton-Stubbs correction. *See*
 three-point correction
 multicomponent analysis, 14, **21–26**, 123, 124
 and isoabsorbance, **70**
 multiple least squares (MLS)
 method, 26

N

NAMAS (National Measurement Accreditation Service), 94
 natural spectral bandwidth (NBW), 46–47
 neodymium yttrium aluminum garnet, 100
 neutral density glass, 96, 100, 106
 filters, 105, 110
 nickel salts, 101, 106
 in nitric/perchloric acid, 105
 NIST (National Institute of Standards and Technology), 39, 104–105, 106, 108, 109
 nitric acid, 105
 noise, **50**, 64, 86, **97**, 112, 117
 NPL (National Physical Laboratory), 39

O

open-topped rectangular cells, 57
 optics, **36**, 59
 forward, 77
 reversed, 38, 77, 78, 126

P

partial least squares (PLS) method, 26
 Peltier temperature controller, 61
 perchloric acid, 101, 105, 107
 pH, 11, 15, 28, **60–61**
 pharmacopoeia
 British, 102, 104
 European, 102–**104**, 106, 108, 111

United States, 92, **104–105**, 106
 phosphorescence, 3
 photochemical reaction, 3, 78
 photodiode detector, 33–34
 photometric accuracy, **49–52**, **96**, 97, 98, 105, 106, 109
 photometric precision, **49–52**, **96**, 106
 photomultiplier tube detector, 33
 polychromator, 37
 potassium chloride, 102, 106, 110
 potassium dichromate, 105, 106
 in perchloric acid, 101
 in sulfuric acid, 101
 potassium iodide, 101, 105, 106, 110
 precision, 58, 64, **86–87**, 92, 117
 photometric, **49–52**, **96**, 106
 wavelength, **47–49**, **95**, 99, 105
 principle component regression (PCR), 26
 prisms, 32
 proteins, 14

Q

qualitative analysis, **10–16**
 quantitative analysis, **16–27**, 56, 62, 95, 96, 124

R

range, **89**
 Rayleigh scattering, 68
 reaction
 photochemical, 3, 78
 reference
 standard, 95, 96
 values, 44
 wavelength, 62, 70, 72, 84
 reflection, 3
 refractive index, **63**
 resolution, 103, 106, **126–127**
 spectral, **44–47**
 reversed optics, 38, 77, 78, 126
 rotational energy, 4
 ruggedness, **91**, **125–126**

S

samarium oxide
 in perchloric acid, 101
 sample decomposition, **78, 127–128**
 sample geometry, **63**
 Savitzky-Golay polynomial
 technique, 9
 scattering, 3, 9, **68–69**, 82, 87, 116
 Rayleigh scattering, 68
 Tyndall scattering, 68
 Schlieren effect, 61, 62
 Schott noise, 50
 selectivity, 28, **89–91**, 124
 self-test, **112**
 sensitivity, 28, 58, 69, **87–89**, 124,
125
 signal-to-noise (S/N), **9–10**, 27, 65
 simple simultaneous equations
 method, **21–24**, 25, 26, 27, 89
 single-beam spectrophotometer, **39**
 single-component quantification, 20
 slit width, **64**, 126
 sodium iodide, 101, 106, 110
 sodium nitrite, 101, 110
 solid absorption standards, **99**
 solvent
 choice of, **59–60**
 effect of, **60–62**
 SOP (standard operating
 procedure), 114
 spectral resolution, **44–47**
 spectrophotometer
 Agilent 8453, 39, 40
 conventional, **36–37**
 diode array, **37–38**
 dual beam, **40–41**
 dual wavelength, **43**
 HP 8450A, 41, 42
 HP 8453, 107, 127
 single beam, **39**
 split beam, **42**
 spectrophotometric titrations, **28**
 split-beam spectrophotometer, **42**
 stability, 31, 41, 43, **98**
 standard deviation, 84–85, 86, 87, 88,
 117, 125
 standard error of regression, 82
 statistical methods, 26, 82
 correlation coefficient, 82, 83, 84,
 116

least squares, 9, **24–25**, 26, 27, 82,
 89
 multiple least squares (MLS), 26
 partial least squares (PLS), 26
 principle component regression
 (PCR), 26
 simple simultaneous equations,
21–24, 25, 26, 27, 89
 standard error of regression, 82
 uncertainty, 82
 statistics, **117, 125**
 stray light, **49–50, 96–97**, 101, 103,
 106, 110–111, **127**
 strong absorbance, **66–67**, 124
 sulfuric acid, 101
 sultone, 122
 system suitability, **113**

T

temperature, 11, **14–15**, 19, 28, **60–**
62
 three-point correction, **72**
 time averaging, **65**, 87, 125
 toluene
 in hexane, 102, 106, 111
 transmittance, **6**, 18, 49
 tungsten-halogen lamp, 31
 Tyndall scattering, 68

U

ultramicrocells, 58
 uncertainty, 82
 United States Pharmacopoeia
 (USP), 92, **104–105**, 106
 unmasked cells, 59

V

vibrational energy, 4

W

wavelength
 accuracy, **47–49, 95**, 99, 101, 105,
 106
 averaging, **65**, 87, 124, 125
 confirmation, 115, 124
 precision, **47–49, 95**, 99, 105
 reference, 62, 70, 72, 84
 reproducibility, 10, 38, 49, 67, 92
 resettability, 48, 49, **124–125**
 weak absorbance, **64–66**
 working curve. *See* calibration curve

X

xenon lamp, 32

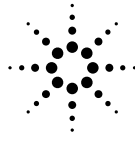

Agilent Technologies

© Copyright Agilent Technologies 2000

All rights reserved. Reproduction, adaptation, or translation without prior written permission is prohibited, except as allowed under the copyright laws.

The information contained in this publication is subject to change without notice.

Printed in Germany 06/00
Publication number 5980-1397E