

KROHNE

▶ measure the facts

Level measurement

Product overview



Contents

4-7	Product selection
8-35	Continuous level measurement
36-43	Level switches
44-45	Communication technology
46-47	KROHNE services
48-49	Calibration

KROHNE trademarks:

KROHNE
CalSys
CARGOMASTER
EcoMATE
EGM
KROHNE Care
OPTIBATCH
OPTIBRIDGE
OPTIFLEX
OPTIFLUX
OPTIMASS
OPTIQUAD
OPTISONIC
OPTISOUND
OPTISWIRL
OPTISWITCH
OPTISYS
OPTIWAVE
PipePatrol
WATERFLUX
SENSOFIT
SMARTBASE
SMARTMAC

Trademarks of other owners:

Amphenol
FDT Group
FOUNDATION™ fieldbus
HART
HASTELLOY
Metaglas
PACTware
PROFIBUS®
VARINLINE



measure the facts

technology driven by KROHNE

Letter from the Corporate Management

Dear Customers,

Communication techniques are becoming ever more complex, from the field through to the control level. At the same time the demands for recording physical measured variables such as flow rates, fill levels, temperature, pressure and analysis parameters are constantly growing. The principal requirement in this respect is absolute reliability of the measured values. This means the measuring equipment, even when subjected to disruptive influences such as changing flow profiles or inclusion of gas bubbles, must always deliver reliable values, and above all must guarantee virtually 100 % security against failure.

“Measure the facts” means not only reliable measurement of standard process variables – even under the most difficult process conditions – but also clear and precise process diagnostics right through to the material composition of the medium. Both of these contribute to improved process control and allow remarkable increases in process efficiency and production.

In order to guarantee this for you, more than 400 engineers in the worldwide KROHNE Group are continuously engaged in research into promising technologies for the future, in pursuit of improved measurement and further developments. We are a family-owned enterprise and we take our responsibilities seriously. We have permanent representation in more than 130 countries and employ more than 3,500 people in order to bring you highly innovative products from a single source, and tailor-made technical solutions to your measurement requirements, now and in the future.



Michael Rademacher-Dubbick

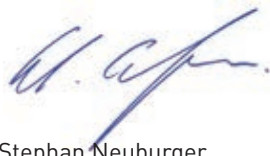

Stephan Neuburger



The solution for any application

KROHNE has unique expertise in the field of level measurement technology. We show our capabilities not only in standard applications, but also in applications which are considered challenging and which require tailor-made solutions. For us, customer orientation begins in the research and development phase. Many of the products, which are now considered industrial standards, were developed by us in cooperation with our customers. Today, users benefit from KROHNE innovations: In 1990, KROHNE introduced the first process radar device and became the pioneer of using radar level measuring technology in process technology. In 1995, KROHNE also became the forerunner in the field of radar devices based on the TDR principle, using guided electromagnetic pulses. With the introduction of OPTIWAVE and OPTIFLEX in 2004, the market discovered the latest generation of radar and TDR technology. These devices are characterized by their high accuracy and reliability, even in difficult applications, and by a unique, innovative operating philosophy. A complete series of level switches for liquids and solids and mechanical level transmitters round out the KROHNE level portfolio. Even for challenging applications, e.g. at the highest temperatures and pressures, KROHNE offers corresponding customer-specific solutions.

Product selection list

The following table will help you in selecting the right measuring principle for your application

	OPTIWAVE 1010	OPTIWAVE 5200 C/F	OPTIWAVE 6300 C	OPTIWAVE 7300 C	OPTIWAVE 8300 C Marine ¹	OPTISOUND 30x0 C
	Page 8/28	Page 8/28	Page 8/28	Page 8/29	Page 8/29	Page 9/30
Measuring principle	FMCW radar 6 GHz	FMCW radar 10 GHz	FMCW radar 24...26 GHz	FMCW radar 24...26 GHz	FMCW radar 24...26 GHz	Ultrasonic
Measuring range ≤ 8 m; ≤ 26.2 ft	x	x	x	x	x	x
Measuring range ≤ 15/30 m; ≤ 49.2/98.4 ft	-	x	x	x	x	x / -
Measuring range ≤ 40/45 m; ≤ 131.2/147.6 ft	-	-	x	x	x / -	x
Measuring range ≤ 80 m; ≤ 262.4 ft	-	-	x	x	-	o
Storage tanks	x	x	x	x	x	x
Still well/reference chambers	x	x	-	x	x	o
Process tanks	x	x	-	x	x	-
Complex process tanks (e.g. with agitators)	x	-	-	x	-	-
Bulk solids	-	-	x	-	-	x
Pressure ≤ 2 barg; ≤ 29 psig	x	x	x	x	x	x
Pressure ≤ 40 barg; ≤ 580 psig	x	x	x	x	x	-
Process connection temperature ≤ +80/150°C; +176/302°F	x	x	x	x	x	x / -
Process connection temperature ≤ +200/250°C; +392/482°F	-	x	x / -	x / -	x / -	-
2-wire technology	x	x	x	x	x	x
4-wire technology	-	-	-	-	-	x
PROFIBUS® PA/FF	-	x	-	-	-	-
Ex	x	x	x	x	x	x
SIL	-	x	-	-	-	-
Marine approvals	-	-	-	-	x	-

¹⁾ marketed through our KROHNE Marine sales office
x = suitable, o = suitable under certain conditions, - = not suitable

Product selection list

The following table will help you in selecting the right measuring principle for your application

	OPTIFLEX 1100 C	OPTIFLEX 2200 C/F	OPTIFLEX 1300 C	OPTIFLEX 4300 C Marine ¹	OPTIBAR
	Page 10/31	Page 10/31	Page 10/31	Page 10/31	Page 13/34/35
Measuring principle	TDR Guided Radar	TDR Guided Radar	TDR Guided Radar	TDR Guided Radar	Hydrostatic pressure level measurement
Measuring range ≤ 20 m; ≤ 65.6 ft	x	x	x	x	x
Measuring range ≤ 35 m; ≤ 114.8 ft	-	x	x	x	x
Measuring range ≤ 40 m; ≤ 131.2 ft	-	x	-	-	x
Storage tanks	x	x	x	x	x
Still well/reference chambers	x	x	x	x	x
Process tanks	o	x	x	x	x
Complex process tanks (e.g. with agitators)	-	o	o	o	x
Bulk solids	x	x	x	x	-
Pressure ≤ 16 barg; ≤ 232 psig	x	x	x	x	x
Pressure ≤ 40 barg; ≤ 580 psig	-	x	x	x	x
Pressure ≤ 300 barg; ≤ 4351 psig	-	-	x	-	x
Process connection temperature ≤ +100°C; ≤ +212°F	x	x	x	x	x
Process connection temperature ≤ +200°C; ≤ +392°F	-	x	x	x	x
Process connection temperature ≤ +300°C; ≤ +572°F	-	x	x	-	x
Interface measurement	-	-	x	x	x
2-wire technology	x	x	x	x	x
PROFIBUS® PA/FF	-	x	-	-	x
Ex	-	x	x	x	x
SIL	-	x	-	-	x
Marine approvals	-	-	-	x	-

x = suitable, o = suitable under certain conditions, - = not suitable

* longer devices on request

	BM 26 BASIC/ ADVANCED	BM 26 A	BM 26 W1010	BM 26 W7300	BM 26 F2200	RC F1300	BW 25	BM 500
	Page 11/32	Page 11/32	Page 11/32	Page 11/32	Page 11/33	Page 11/33	Page 11/33	Page 11/33
Measuring principle	Magnetic bypass level indicator (MLI)	Magnetic bypass level indicator (MLI)	FMCW radar/magnetic bypass level indicator (MLI)	FMCW radar/magnetic bypass level indicator (MLI)	TDR guided radar/magnetic bypass level indicator (MLI)	TDR guided radar/magnetic bypass level indicator (MLI)	Displacer	Potentiometric
Measuring range	5.3 m*; 17.4 ft*	5.5 m*; 18 ft*	8 m; 26.2 ft	5.4 m*; 17.7 ft*	5.5 m*; 18 ft*	5.5 m*; 18 ft*	5.5 m*; 18 ft*	3 m; 9.8 ft
Storage tanks	x	x	x	x	x	x	x	x
Still wells/ reference chambers	x	x	x	x	x	x	x	x
Process tanks	x	x	x	x	x	x	x	-
Complex process tanks (e.g. with agitators)	x	x	x	x	x	x	o	-
Bulk solids	-	-	-	-	-	-	-	-
Pressure ≤ 40 barg; ≤ 580 psig	-	x	x	x	x	x	x	-
Flange temperature ≤ +150/200°C; ≤ +302/392°F	x	x	x/ -	x	x	x	x	-
Flange temperature ≤ +300°C; ≤ +572°F	x	x	-	-	x	x	x	-
Interface measurement	-	x	-	-	-	x	x	-
2-wire technology	x	x	x	x	x	x	x	-
4-wire technology	-	-	-	-	-	-	x	x
PROFIBUS® PA/FF	x	x	-	x	x	x	x	-

x = suitable, o = suitable under certain conditions, - = not suitable
* longer devices on request



OPTIWAVE 1010
2-wire FMCW radar welded to
BM 26 ADVANCED, bypass chamber
or magnetic level indicator (MLI)



OPTIWAVE 5200 C
2-wire FMCW radar
for liquid applications



OPTIWAVE 5200 F remote version
2-wire FMCW radar
for liquid applications



OPTIWAVE 6300 C
Drop antenna
2-wire FMCW radar
for solid applications



OPTIWAVE 6300 C/7300 C
Drop antenna
2-wire FMCW radar with
flange plate protection for
corrosive media



OPTIWAVE 7300 C
Horn antenna
2-wire FMCW radar for
liquid applications



OPTIWAVE 7300 C
2-wire FMCW radar for
hygienic applications



OPTIWAVE 8300 C Marine
2-wire FMCW radar for
marine applications marketed
through our KROHNE Marine
sales office



OPTISOUND 3010 C
2-/4-wire ultrasonic level
transmitter for small tanks



OPTISOUND 3030 C
2-/4-wire ultrasonic level
transmitter for medium
sized tanks



OPTISOUND 3020 C
2-/4-wire ultrasonic level
transmitter for small and
medium-sized tanks



OPTISOUND VU30/VU31
Ultrasonic level and open channel flow meter

Continuous level measurement



OPTIFLEX 1100 C
2-wire TDR guided radar
for storage or standard
process applications



OPTIFLEX 2200 C
2-wire TDR guided radar for
solid and liquid applications



OPTIFLEX 2200 F remote version
2-wire TDR guided radar for
solid and liquid applications



OPTIFLEX 1300 C
2-wire TDR guided radar for solid,
liquid and interface applications



OPTIFLEX 4300 C Marine
2-wire TDR guided radar for marine
applications marketed through our
KROHNE Marine sales office



BM 26 BASIC/
ADVANCED
Magnetic bypass level
indicator (MLI) for
liquid applications
(tube inner diameter
38.4 mm / 1 1/2")



BM 26 A
Magnetic bypass level
indicator (MLI) for
liquid and interface
applications (tube
inner diameter
67.4 mm / 2.65")



BM 26 W1010
BM 26 ADVANCED
with welded
OPTIWAVE 1010
for liquid
applications



BM 26 W7300
BM 26 A with
OPTIWAVE 7300
for liquid
applications



BM 26 F2200
BM 26 A with
OPTIFLEX 2200
for liquid level
and/or interface
applications



RC F1300
Reference chamber
with OPTIFLEX 1300
for liquid level and/or
interface applications



BM 500
4-wire potentiometric
level transmitter for
hygienic applications



BW 25
Broadband displacer level
transmitter for high pressures
and temperatures

Continuous level measurement

The modular product line

Pressure transmitters



OPTIBAR P 2010
Ultra-compact pressure transmitter
with flush metallic diaphragm also
for hygienic applications



OPTIBAR PC 5060
Process pressure transmitter with
ceramic diaphragm for pressure and
level measurement



OPTIBAR PM 5060
Process pressure transmitter with
metallic diaphragm also for high pressure
ranges and hygienic applications



OPTIBAR DP 7060
Differential pressure transmitter
for hydrostatic level measurement
with integrated absolute pressure
measurement

Diaphragm seals

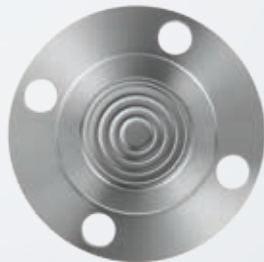

OPTIBAR DS series
Diaphragm seals for temperatures up to +450 °C / +842 °F or corrosive mediums



OPTIBAR DS direct
Differential pressure transmitter with direct mounted single-sided OPTIBAR DS diaphragm seal



OPTIBAR DS capillary
Differential pressure transmitter with capillary mounted two-sided OPTIBAR DS diaphragm seal



OPTIBAR DS direct/capillary
with combined direct/capillary mounted two-sided OPTIBAR DS diaphragm seal

Submersible probes



OPTIBAR LC 1010
Submersible level probe with ceramic diaphragm 22 mm / 1" diameter

Accessories

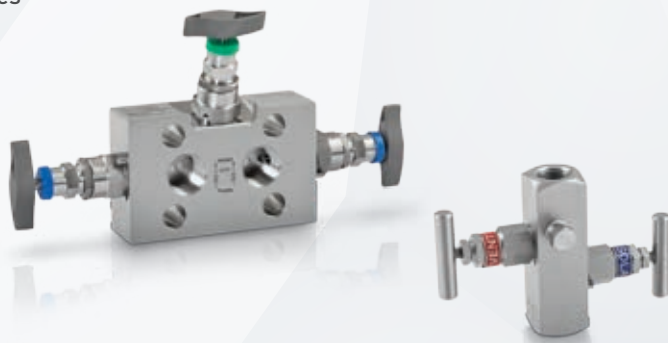

Accessories for safe and easy installation of pressure transmitters in the process:

- Manometer and barstock valves, 3-/5-way valve manifolds, also for steam and high temperature applications
- Flange adapter according to DIN EN and ASME
- Condensate pots for steam applications
- Straight and curved connecting pipes, syphons in U- and circular shapes
- Fittings, seals, blind-plugs, oval flange adapter and gauge snubber

Continuous level measurement



Radar

Continuous level measurement via radar is based on the theory of the propagation of electromagnetic waves, put forth by the British physicist James C. Maxwell in 1865. Maxwell postulated that the field lines of a changing magnetic field are surrounded by annular electrical field lines, even in the absence of electrical conductors.

Inspired by this theory, German physicist Christian Hülsmeyer immediately applied for a patent for his telemobiloscope, the first radar device of this type in Düsseldorf in 1904. For this innovation, he is rightly known as the inventor of the „original radar.“

In 1990, KROHNE introduced the first radar level transmitter for process tanks.

FMCW:

Frequency Modulated Continuous Wave

The measuring principle

A radar signal is emitted via an antenna, reflected on the product surface and received after a time t . The radar principle used is FMCW (Frequency Modulated Continuous Wave). The FMCW radar emits a high frequency signal whose frequency increases linearly during the measurement phase (called the frequency sweep). The signal is emitted, reflected from the measuring surface and received with a time delay, t . Delay time, $t=2d/c$, where d is the distance to the product surface and c is the speed of light in the gas above the product. For further signal processing the difference Δf is calculated from the actual transmit frequency and the receive frequency. The difference is directly proportional to the distance. A large frequency difference corresponds to a large distance and vice versa. The frequency difference Δf is transformed via a Fourier transformation (FFT) into a frequency spectrum and then the distance is calculated from the spectrum. The level results from the difference between tank height and measuring distance.

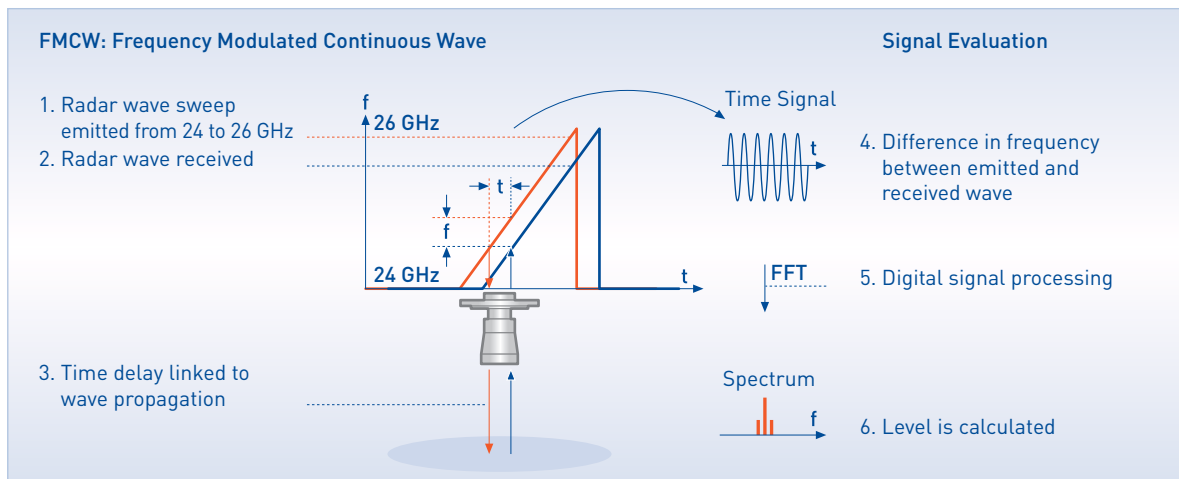

TDR: Time Domain Reflectometry

The measuring principle

The guided radar (TDR) level transmitter has been developed from a tried and tested technology called Time Domain Reflectometry (TDR).

The device emits low-intensity electromagnetic pulses of approximately one nanosecond width which are guided along a rigid or flexible conductor. These pulses move at the speed of light. When the pulses reach the surface of the product to be measured, they are reflected with an intensity that depends on the dielectric constant, ϵ_r , of the product (e.g., water has a high dielectric constant and the pulse is reflected back to the transmitter at 80 % of its original intensity).

The device measures the time from when the pulse is transmitted to when it is received: half of this time is equivalent to the distance from the reference point of the device (the flange facing) to the surface of the product. The time value is converted into an output current of 4 to 20 mA and/or a digital signal.

Dust, foam, vapor, agitated surfaces, boiling surfaces, changes in pressure, temperature and density do not have an effect on device performance.

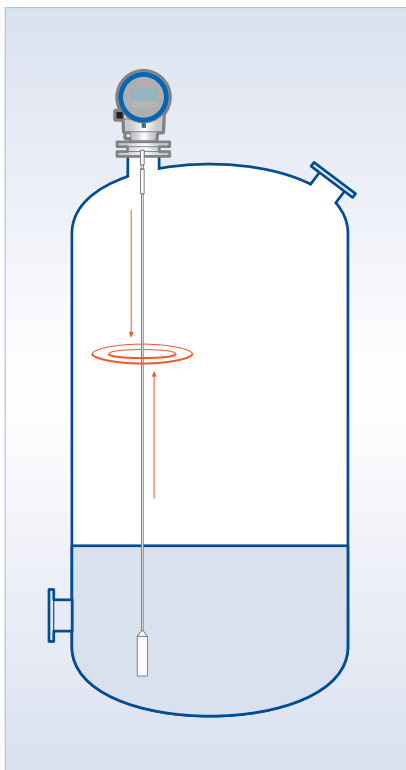

Highlights:

- Radar and TDR devices for liquid and solid applications
- Reliable measurement, even in tanks with moving surfaces, foam or inserts
- Suitable for very low or very high process temperatures/pressures (process connection temperature/pressure limits to be observed)
- Optional second current output for transferring additional measurement data
- Measuring distances up to 80 m; 262.47 ft
- Measurement of interfaces starting at 50 mm; 1.97"
- High standard accuracy beyond ± 2 mm; 0.08"
- Large choice of probes to cover most applications
- Innovative antenna solutions e.g. for corrosive media, condensation, dusty atmosphere or heating/cooling applications
- Remote version up to 100 m; 328 ft
- Quick coupling system: converter can be rotated and removed under process conditions
- Metaglas® dual process sealing system for dangerous products
- Modular design from mechanics to converter
- SIL2-compliant acc. to IEC 61508 for safety-related systems
- FOUNDATION™ fieldbus, PROFIBUS® PA and HART® communication

User-friendly installation and set-up OPTIFLEX and OPTIWAVE family

Highlights:

- Quick coupling system permits removal of the converter under process conditions
- Remote converter: up to 100 m; 328 ft away from the probe
- Easy installation using Quick Setup wizards with comprehensive help functions
- Intuitive navigation using a touchscreen (4-button operation)
- Display in nine languages, including Chinese (simplified) Japanese and Russian

With the TDR and FMCW radar level transmitters that leave our factory you not only get the experience and expertise of nearly two decades, but also an operating concept that sets a new standard for the industry.

This starts with the high-resolution, user-friendly display for simple and comfortable operation, followed by easy set-up with the help of our installation wizard. For additional ease of use, the display keypad is accessible without having to open the housing. Besides, the quick-coupling system permits removal of the converter under process conditions and also rotation through 360°.

With the innovative, modular housing of the OPTIFLEX 2200 C/F and OPTIWAVE 5200 C/F, the customer can specify the orientation and the position of the display. This makes it accessible, regardless of whether it is installed on a tank, in a recess or in buildings with small clearance to e.g. the roofs. The F-version features a remote installed signal converter with display and keypad. It allows installation and operation up to 100 m; 328 ft away from the antenna, e.g. in a control room or at the bottom of the tank. Both, OPTIFLEX 2200 C and OPTIWAVE 5200 C are designed and developed for use in safety-related systems according to IEC 61508 (SIL 2). Their converters are backwards compatible with flange systems of former TDR and FMCW radar transmitter from KROHNE. This will quickly bring your existing measuring equipment up to date so that it conforms to the highest standards and provide you with options such as SIL, ATEX, FOUNDATION™ fieldbus, PROFIBUS® PA and HART®.

The mechanical design of our OPTIFLEX/OPTIWAVE series features a selection of unique probes and antennas for standard and corrosive products making it ideal for all industries and a large variety of liquid and solid applications.

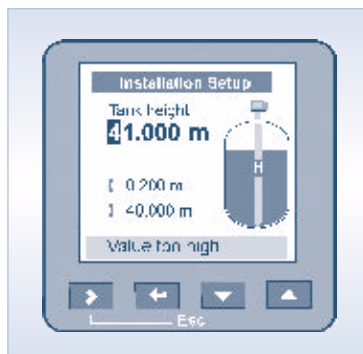
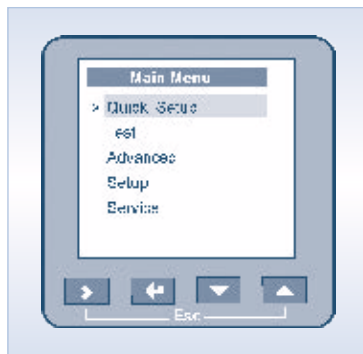

Empty spectrum

All interference reflections, which are caused by fixed or moving tank inserts and the bottom of the tank, can be detected and saved by recording an empty spectrum. The surface reflections are reliably detected, distinguished from interference reflections and analyzed by comparing the empty spectrum to the reflections in the filled state. For applications with tanks that cannot be emptied at the time of the start-up, the radar transmitter offer the capability of recording a partially empty spectrum.

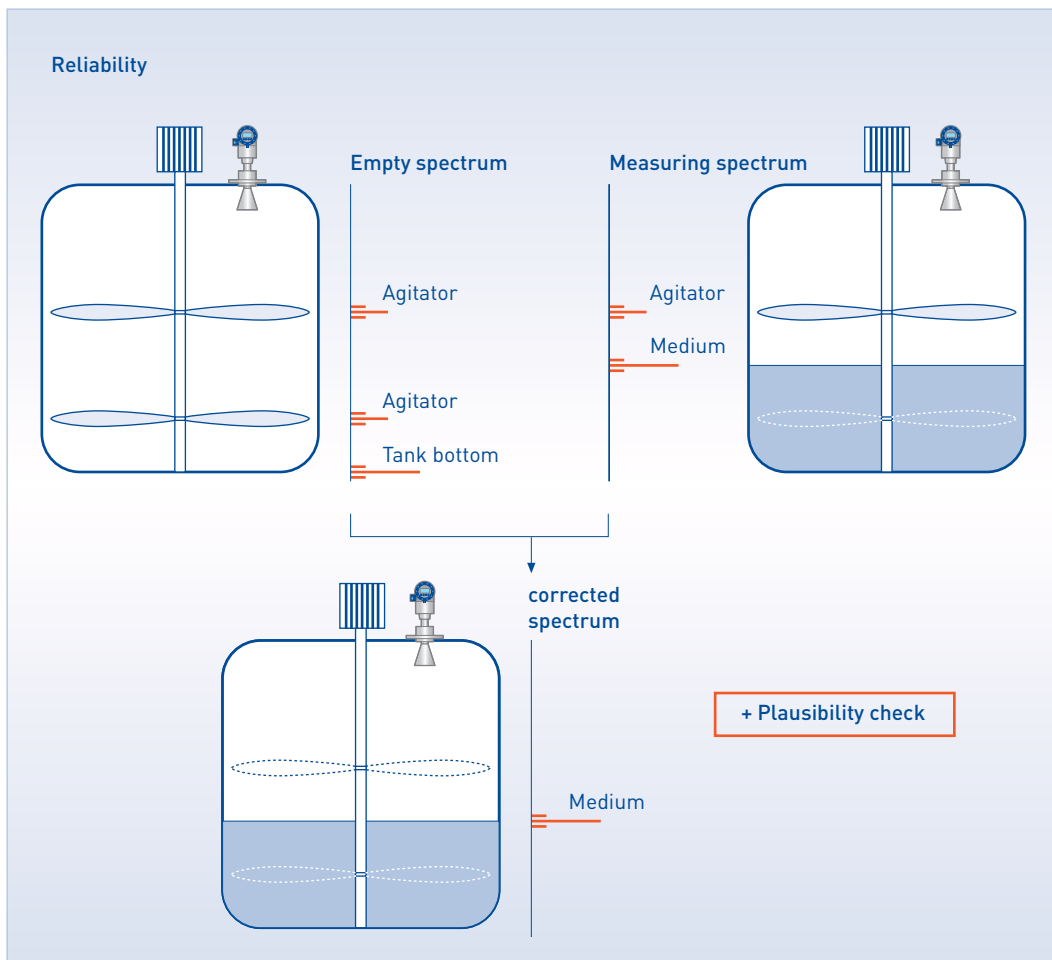

Ultrasonic

Highlights:

- Continuous level measurement of liquids and solids
- Suitable for sumps, water and wastewater basins
- Non-contact flow measurement and detection in open channels
- Level detection of solids in silos and storage tanks
- Level measurement in stone crushers
- Profile measurement on conveyor belts

The measuring principle

Short ultrasonic pulses in the range of 18 to 70 kHz are sent from the signal transducer to the product to be measured, reflected from the surface of the fill goods and received by the signal transducer. The pulses propagate at the speed of sound, where the time between the sending and receiving of the signals depends on the level in the tank. The latest microprocessor technology and the tried and tested analysis software ensure that you will be able to reliably determine the level echo even when interference reflections are present and to calculate the exact distance to the surface of the fill goods. To compensate for the duration of the acoustic signal, an integrated sensor detects the temperature in the tank.

A level-proportional signal is formed from the distance by simply inputting the tank dimensions. It is not necessary to fill the tank for the adjustment.

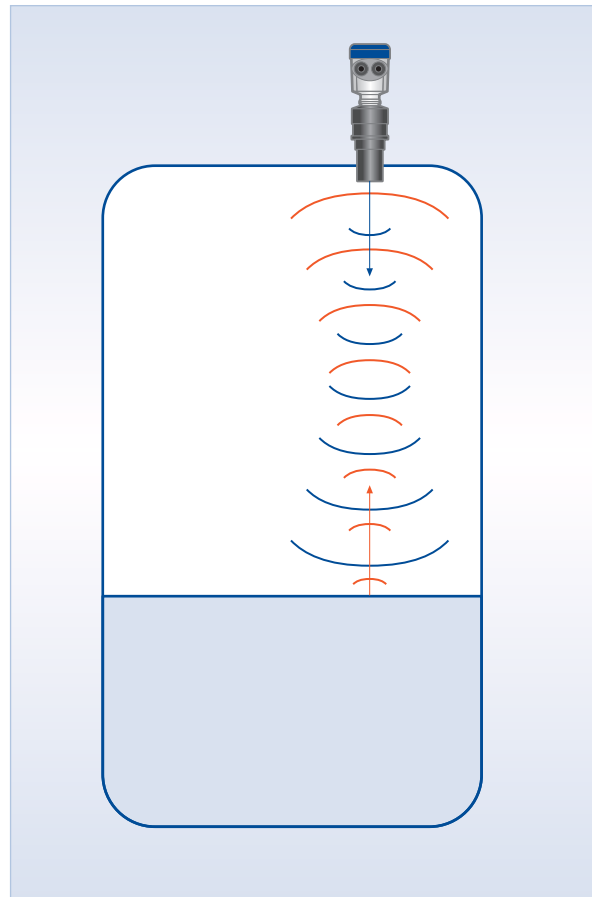



OPTISOUND – The innovative ultrasonic solution for liquids and solids

Ultrasonic level transmitters from KROHNE are used for continuous measurement of liquids and bulk goods in nearly all sectors of industry.

With the OPTISOUND, KROHNE introduced a family of products at Interkama 2005, which impressively demonstrates its superiority, particularly in open channels, in process tanks and in storage tanks, but also in basins, wastewater tanks and on conveyor belts. Continuous ultrasonic level measurement has proven itself in the field of „free level measurement.“

OPTISOUND is suitable for rainwater and wastewater, for low and high degrees of contamination, for silting or for liquids with a percentage of solids: in this case, the OPTISOUND can make full use of the advantages of contact-free measurement.

Bulk goods naturally pose different challenges to a transmitter than do liquids.

The surface of the product is not smooth, but generally forms a cone of bulk goods. Many products cause a heavy dust build-up. In addition, most solid silos are taller than the tanks for liquids. In this case too, OPTISOUND is the best choice.

By means of differently adjusted transmitting frequencies, the device can measure levels in a range from 0.25 to 15 m / 0.82 to 49.2 ft for liquids, from 0.25 to 7 m / 0.82 to 23 ft for solids. Another advantage: Depending on the design, highly resistant materials for acoustic signal transducers and process connections guarantee their use, even with caustic media. Ingenious details such as an optionally available mounting bracket for easy alignment of the sensor round out the extremely positive overall impression of this series of devices.

Industries:

- Water and wastewater
- Chemical
- Metal
- Power generation
- Pulp and paper

Highlights:

- Proven technology with more than 50 years of experience in manufacturing
- Rugged stainless steel design – low or no maintenance
- Flaps housed in a hermetically sealed glass tube (IP68)
- Highly visible level indication works without power supply
- Large variety of accessories and options: special materials, valves, high and low temperature insulation, hazardous area approvals, limit switches, analogue and radar transmitters, interface measurement etc.
- Measuring ranges from 0.3 m; 1 ft up to 5.5 m; 18 ft (longer on request)
- Totally redundant measurement by technology and predictive maintenance monitoring possible when equipped with two independent transmitters

Industries:

- Water and wastewater
- Chemical
- Metal
- Power generation
- Pulp and paper
- Oil and gas
- Automotive

Float

The measuring principle

The magnetic bypass level indicator (MLI) operates on the principle of communicating vessels. The measuring chamber is connected adjacent to the tank so that the same conditions are obtained in the chamber as those in the tank. The float is equipped with a system of permanent magnets to transmit measured values to the local indicator. The magnet system of the float activates either the magnetic flaps according to the liquid level, or a movable follower magnet in the indicating section of the indicator depending on the method of indication chosen. The column of reversed yellow magnetic flaps, or the vertical position of the follower magnet, indicates the liquid level.

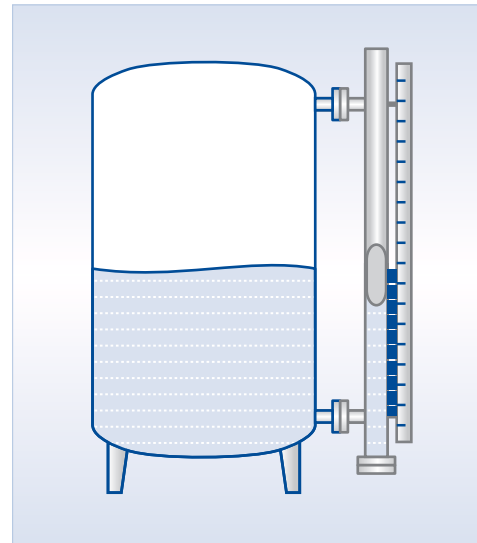

BM 26
BASIC/ADVANCED



BM 26 W1010



BM 26 A



BM 26 F2200

BM 26 BASIC/ADVANCED – Applications up to 40 barg / 580 psig

These two indicators use the same proven technology as other devices in the BM 26 range and offer the best price/performance ratio. Their optimal design keeps weight to a minimum. The BASIC version is ideal for measuring liquids in low-pressure storage and process tanks. The ADVANCED version, designed for chemical or petrochemical processes, indicates the level of hydrocarbons in refining applications etc.

BM 26 A – The universal float solution for level or separating layer

This indicator operates over a wide temperature range and at high pressures. It is also the perfect device for restricted spaces. The PTFE lined as well as the KP versions can be used with corrosive liquids.

BM 26 W / F – Measurement with double certainty

BM 26 A combined with an OPTIWAVE 7300 C FMCW radar level transmitter (BM 26 W) or an OPTIFLEX 1300 C TDR guided radar level transmitter (BM 26 F) permits totally redundant measurement where the measuring results of the radar transmitter can be checked against those from the Magnetic bypass Level Indicator (MLI). Both technologies operate independently and are not influenced by each other. If the pressure does not exceed 40 barg / 580 psig, we recommend BM 26 ADVANCED with the OPTIWAVE 1010 FMCW radar level transmitter option.

By adding an externally-mounted analogue transmitter to these device combinations, equipment condition can be monitored and a predictive maintenance strategy is possible: maintenance can be planned sufficiently in advance, and at DCS level, by comparing the measuring results of the analogue transmitter with those of the radar transmitter.



Displacer

Highlights:

- Suitable for use under extreme process conditions
- Resistant to temperatures ranging from -60 to $+400$ °C; -76 to $+752$ °F and pressures up to 400 barg; 5800 psig
- Level and interface measurement
- Modular design, which makes retrofitting possible without interrupting the process
- Pressure-proof isolation of the measuring and displaying room

The measuring principle

The BW 25 level indicator works according to the displacer principle. In this principle, the length of the displacement element rod corresponds to the measuring range. The body, which is suspended on a measuring spring, is immersed in the liquid where it determines the lifting force that is proportional to the displaced mass of the liquid (Archimedean principle). Any change to the weight of the rod corresponds to a change in the length of the spring and is therefore a measure of the level. The extension of the length of the spring, and thereby the measuring stroke, are transmitted to a display from the measuring room.

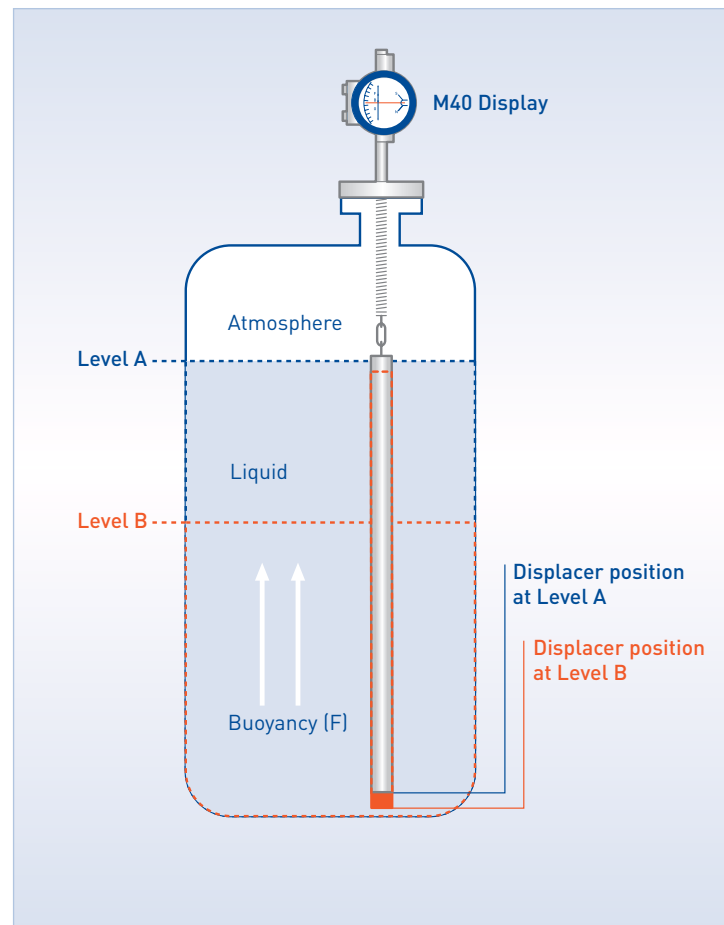

Industries:

- Petrochemical
- Chemical
- Power generation



Displacer BW 25 – Sovereign even under extreme process conditions

The BW 25 is a true all-rounder for measuring level or interface of various liquids under extreme process conditions.

It can deal with corrosive media, high temperatures (up to +400 °C / +752 °F) and high pressures (up to 400 barg / 5800 psig). Retrofitting the converter and adding switches to the device is possible without interrupting the process. The BW 25 can also be installed in a bypass chamber e.g. applications with agitators.



BW 25 with M40 display

Potentiometric process

Highlights:

- Measurement independent of media properties
- Not sensitive to adhesives and foam
- Up to 3 m; 9.8 ft probe length
- Defined empty reporting function
- Potted design
- Quick response time
- Automatic position detection
- Level measurement beyond 50 mm; 1.97"
- High temperature resistance (+140 °C; +284 °F)
- Remote version available

The measuring principle

The BM 500 level transmitter works according to the potentiometric measuring principle and can only be used with a minimum conductivity of 50 $\mu\text{S}/\text{cm}$ for all electrically conductive media (e.g. pure water).

The level probe (sensor) consists of a low-resistance measuring tube, which is immersed in an electrically conductive liquid. An AC generator runs a higher frequency current through the measuring tube. A voltage is taken from between the probe and the tank wall and sent to an amplifier. In homogeneous conditions in the medium, this is proportional to the level.

The potentiometric measuring method is particularly suitable for measuring levels in small vessels containing tough, pasty or strongly adhesive media. The electronic evaluation unit is integrated in the signal converter and supplies a level-proportional output signal of 4 to 20 mA.

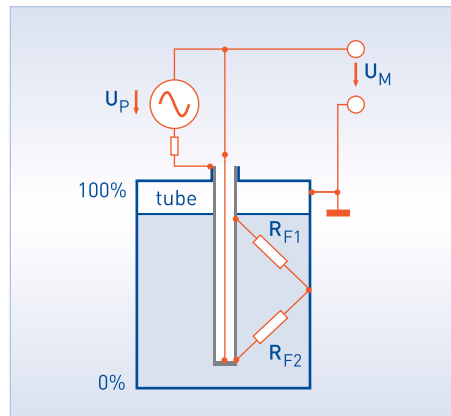

BM 500 for hygienic applications

Industries:

- Food and beverage
- Pharmaceutical

Whether you are dealing with fruit juice, ketchup, beer, toothpaste or mustard: for tough, pasty or highly adhesive media, the BM 500 level transmitter is the first choice.

Especially in small tanks, the potentiometric measuring process can make full use of its advantages. Thus, the BM 500 already measures starting at a level of 50 mm / 1.97" and wins you over with its very fast response time.

Hygienic adaptation for the food and beverage industry and for the pharmacy is guaranteed by a process welded sleeve. CIP and sterilization processes are not a problem thanks to the high temperature resistance of the BM 500.

Hydrostatic pressure level measurement

Hydrostatic pressure is used to measure the level or density of a liquid in a vessel.

KROHNE's OPTIBAR modular product line offers a complete portfolio for measuring the level of corrosive and non-corrosive liquids and slurries in open or closed/pressurised vessels.

Applications include:

- Measuring the level of liquids in open and pressurised vessels
- Level measurement in vessels with agitators
- Hygienic level measurement
- Monitoring steam boilers
- Level or interface measurement in distillation columns
- Measuring the level in water wells, rainwater retaining/overflow basins.

You can combine OPTIBAR pressure transmitters with diaphragm seals for high process temperatures up to +450°C / +842°F and corrosive mediums. They can also be equipped with different hygienic and pharmaceutical process connections.

Submersible probes are also available and may be used as a simple measurement solution for wells or tanks. These are perfectly suited for water and wastewater applications.

Highlights:

- Level, density or interface measurement of liquids in vessels
- Medium temperatures up to +450°C / +842°F
- Process pressure up to 420 bar / 6091 psi
- Not affected by fixed or moving inserts/ agitators
- Not affected by process conditions: dust, foam, vapour, agitated or boiling surfaces, or pressure changes
- Large portfolio of process connections suitable for any industry application
- Different hygienic process connections for a hygienic, dead zone-free installation
- Differential pressure transmitter with integrated absolute pressure measurement to measure head pressure
- Measuring range starting at 10 mbar / 0.14 psi
- Interface measurement over large measuring span
- Multiple functions for vessel linearisation integrated in converter
- NACE compliant materials
- Use in hazardous areas
- Smallest measuring span 10 mbar / 0.145 psi gauge
- 4...20 mA HART® 7 / HART® SIL2/3, FOUNDATION™ fieldbus, PROFIBUS® PA as communication options



Hydrostatic pressure level measurement in open vessels

The measuring principle

In an open vessel, the contents are connected to the atmosphere. Any change of ambient pressure causes a change of pressure of the fluid in the vessel.

In order to measure the change of the fluid column in the vessel, gauge pressure transmitters or differential pressure transmitters (with open low pressure side) are used to measure hydrostatic pressure in the vessel.

Using Pascal's law, the height a of the liquid level can be calculated from the hydrostatic pressure P , the gravity acceleration g and the liquid density ρ .

$$P_{0\%} = \rho \times g \times a$$

$$P_{100\%} = \rho \times g \times (a+h)$$



OPTIBAR LC 1010 C



OPTIBAR P 2010



OPTIBAR PC 5060



OPTIBAR PM 5060

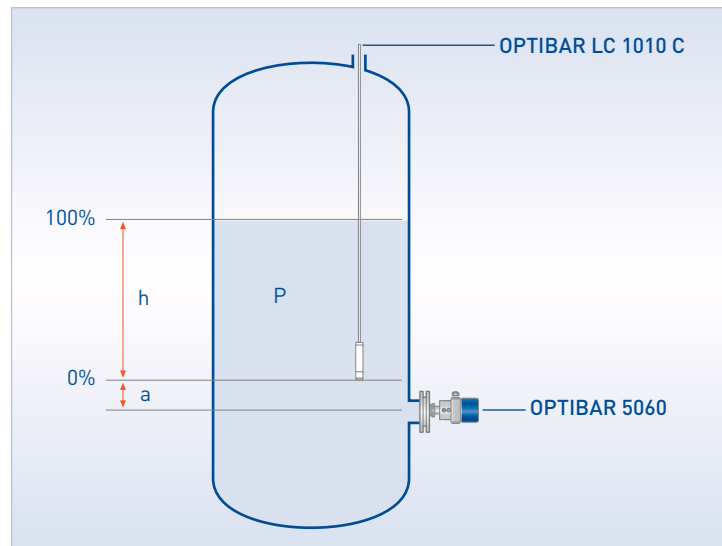

OPTIBAR pressure transmitters for open vessels

You can use OPTIBAR process pressure transmitters to measure the level or density of a liquid in open vessels under atmospheric conditions.

- OPTIBAR PM 5060 and OPTIBAR P 2010 with fully welded metallic diaphragm also for aseptic/hygienic applications
- OPTIBAR PC 5060 with ceramic measuring cell also for abrasive or corrosive liquids, and small measuring ranges of H₂O: 0.25 m / 10"

Hydrostatic pressure level measurement in closed/pressurised vessels

The measuring principle

The pressure in a closed vessel can assume any value. In order to measure the true hydrostatic pressure of the volume in the tank, a differential pressure between the head pressure and the total pressure at the bottom of the vessel needs to be measured at the same time.

Therefore, the high pressure side H is connected to the tank bottom and the low pressure side L is connected to the top. This ensures that the differential pressure applied to the transmitter is proportional to the height of the liquid, regardless of the head pressure inside of the vessel.

By using Pascal's law, the height a of the liquid level can be calculated from the hydrostatic pressure P , the gravity acceleration g , the liquid density ρ , and the distance between the two process connections.

$$P_{0\%} = g \times (a \times \rho_{FL} + (h+c) \times \rho_G - (b+c) \times \rho_{DS})$$

$$P_{100\%} = g \times ((a+h) \times \rho_{FL} + c \times \rho_G - (b+c) \times \rho_{DS})$$

Industries:

- Oil and gas
- Chemical and petrochemical
- Energy
- Food and beverage
- Mining
- Metal

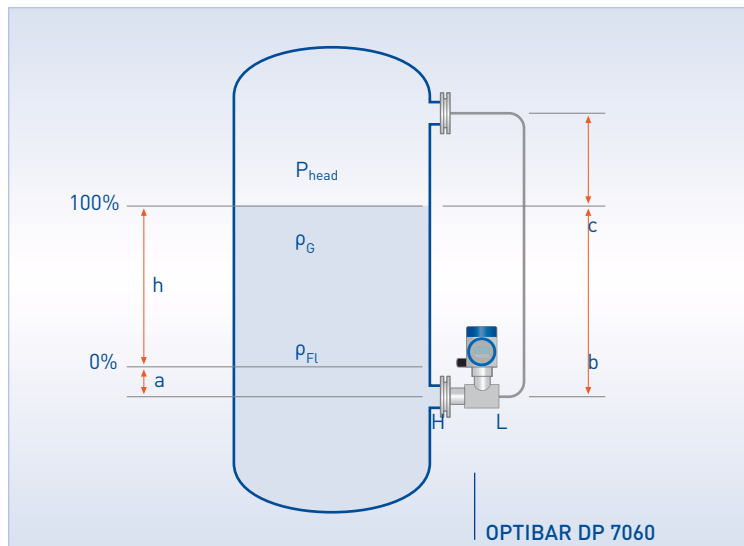



Differential pressure transmitters for closed/pressurised vessels



- The OPTIBAR DP 7060 differential pressure transmitter is ideal for precise level measurement of pressurised containers up to 420 bar / 6091 psi, with integrated head pressure measurement

If the level of a liquid is known, the DP transmitter can also be used to measure the density of the liquid or the position of interface between two liquids of different density.







OPTIBAR DP 7060

	2-wire FMCW radar welded to BM 26 Advanced, bypass chamber or magnetic level indicator (MLI)	2-wire FMCW Radar for liquid applications	2-wire FMCW radar for solid applications
	OPTIWAVE 1010	OPTIWAVE 5200 C/F	OPTIWAVE 6300 C
			
Frequency range	C-band/6 GHz	X-band/10 GHz	K-band/24...26 GHz
Measurable products	Liquids	Liquids, pastes, slurries	Powders, granulates, bulk solids
Level	+	+	+
Measuring range	≤8 m; ≤26.2 ft	1...30 m; 3.3...98 ft	0.2...80 m; 0.7...263 ft
Dielectric constant ϵ_r	Not applicable; if $\epsilon_r < 3$, a float with a target is used	≥1.8	≥1.5
Accuracy	±5 mm; ±0.2"	±5 mm; ±0.2"	±3 mm; ±0.12"
Outputs	mA (HART®)	mA (HART®) FF / PROFIBUS® PA	mA (HART®); optional: 2nd current output mA (non-HART®)
Power supply	2-wire: 14.5...36 VDC (non-Ex and Ex d), 14.5...30 VDC (Ex i)	2-wire: 12...30 VDC (non-Ex and Ex i), 16...36 VDC (Ex d)	2-wire: 14...30 VDC (non-Ex and Ex i), 20...36 VDC (Ex d)
Housing material	Aluminium, stainless steel	Aluminium, stainless steel	Aluminium, stainless steel
Ambient temperature	-40...+85°C; -40...+185°F	-40...+80°C; -40...+176°F	-40...+80°C; -40...+176°F
Protection category	IP66/67	IP 66/67; NEMA4X/6P	IP66/67; NEMA4X/6P
Flange system			
Process connection			
Thread	G1/2; 1/2" NPT (bypass chamber)	G1 1/2...2; 1 1/2...2" NPT	G1 1/2; 1 1/2" NPT
EN	DN15...50; PN40 (bypass chamber)	DN50...200; PN16, 40	DN80...200 in PN16, 40
ASME	1/2...2"; 150 lb, 300 lb (bypass chamber)	2...8"; 150 lb, 300 lb	3...4" in 150 lb/300 lb, 6...8" in 150 lb
JIS	-	50...200A in 10K	80...100A in 10K
Hygienic	-	-	-
Pressure range			
Process	-1...40 barg; -14.5...580 psig	-1...40 barg; -14.5...580 psig, higher on request	PP Drop antenna: -1...16 barg; -14.5...232 psig all other antennas: -1...40 barg; -14.5...580 psig,
Temperature range			
Process	-40...+150°C; -40...+302°F	-60 ...+250°C; -76 ...+482°F, higher on request	PP Drop antenna: -40...+100°C; -40...+212°F PTFE Drop antenna: -50...+150°C; -58...+302°F Horn antennas with distance piece: -50...+200°C; -58...+392°F
Materials			
Wetted parts	Stainless steel, PEEK cone	Stainless steel, PP, PTFE, others on request	Horn antenna: stainless steel (1.4404/316L) Drop antenna: PTFE, PP; optional PP or PTFE flange plate protection
Gaskets	FKM/FPM, Kalrez® 6375, EPDM, others on request	FKM/FPM, Kalrez® 6375, EPDM, PFA, others on request	FKM/FPM, Kalrez® 6375, EPDM, others on request
Approvals			
Ex	ATEX, IECEx, NEPSI, EAC (pending), FM (pending)	ATEX, IECEx, cFMus, NEPSI, INMETRO, EAC	ATEX, IECEx, FM, CSA, NEPSI, INMETRO, EAC, KGS
Miscellaneous	NACE	SIL2, CRN, WHG, NACE	CRN





	2-wire FMCW radar for liquid applications	2-wire FMCW radar for marine applications
	OPTIWAVE 7300 C	OPTIWAVE 8300 C Marine ¹⁾
		
Frequency range	K-band/24...26 GHz	K-band/24...26 GHz
Measurable products	Liquids, pastes, slurries	Liquids
Level	+	+
Measuring range	0.2...80 m; 0.7...263 ft	0.2...40 m; 0.7...131 ft
Dielectric constant ϵ_r	≥ 1.5	≥ 1.5
Accuracy	± 3 mm; ± 0.12 "	± 2 mm; ± 0.08 "
Outputs	mA (HART®); optional: 2nd current output mA (non-HART®)	mA (HART®)
Power supply	2-wire: 14...30 VDC (non-Ex and Ex i), 20...36 VDC (Ex d)	2-wire: 14...30 VDC (non-Ex and Ex i)
Housing material	Aluminium, stainless steel	Stainless steel
Ambient temperature	-40...+80°C; -40...+176°F	-40...+70°C; -40...+158°F
Protection category	IP66/67; NEMA4X/6P	IP66/67; NEMA4X/6P
Flange system		
Process connection		
Thread	G1 1/2; 1 1/2" NPT	-
EN	DN40...150 in PN16, 40, 63, 100; DN200 in PN16, 40	DN125 in PN16
ASME	1 1/2...4" in 150 lb/300lb/600lb/900lb, 6" 150 lb/300 lb, 8" 150 lb	-
JIS	40...100A in 10K	-
Hygienic	Tuchenhausen VARIVENT® DN50, NEUMO BioControl®, Tri-Clamp 2", DIN 11851 DN50, SMS 51	-
Pressure range		
Process	PP Drop antenna: -1...16 barg; -14.5...232 psig PTFE Drop antenna: -1...40 barg; -14.5...580 psig, Hygienic -1...10 barg; -14.5...145 psig, Horn antennas: -1...100 barg; -14.5...1450 psig	Horn antenna: -1...40 barg; -14.5...580 psig
Temperature range		
Process	PP Drop antenna: -40...+100°C; -40...+212°F PTFE Drop antenna: -50...+150°C; -58...+302°F Hygienic antenna: -20...+150°C; -4...+302°F Horn antennas with distance piece: -50...+200°C; -58...+392°F	Horn antenna: -40...+200°C; -40...+392°F
Materials		
Wetted parts	Horn antenna: stainless steel (1.4404/316L) or Hastelloy® C-22 (2.4602) Drop antenna: PTFE, PP; optional PP or PTFE flange plate protection Hygienic antenna: PEEK	Horn antenna: stainless steel (1.4404/316L) or 3% Molybden Mo
Gaskets	FKM/FPM, Kalrez® 6375, EPDM, others on request	FKM/FPM, Kalrez® 6375, others on request
Approvals		
Ex	ATEX, IECEx, FM, CSA, NEPSI, INMETRO, EAC, KGS	ATEX
Miscellaneous	WHG, FDA, NACE, CRN	Marine approvals: DNV, ABS, GL, LR, BV, CCS, NK, RINA, KR





1) marketed through KROHNE Marine sales office



	2-/4-wire ultrasonic level meter for small tanks	2-/4-wire ultrasonic level meter for small and medium-sized tanks	2-/4-wire ultrasonic level meter for medium-sized tanks	Ultrasonic level and open channel flow meter	Ultrasonic level and open channel flow meter
	OPTISOUND 3010 C	OPTISOUND 3020 C	OPTISOUND 3030 C	OPTISOUND VU30	OPTISOUND VU31
					
Frequency range	70 kHz	55 kHz	35 kHz	50kHz	50kHz
Measurable products	Liquids and solids	Liquids and solids	Liquids and solids	Liquids and solids	Liquids and solids
Level/interface	+/-	+/-	+/-	+/-	+/-
Measuring range	Liquids: 0.25...5 m; 0.82...16.4 ft Solids: 0.25...2 m; 0.82...6.6 ft	Liquids: 0.4...8 m; 1.3...26.2 ft Solids: 0.4...3.5 m; 1.3...11.5 ft	Liquids: 0.6...15 m; 2...49 ft Solids: 0.6...7 m; 2...23 ft	0.3...9.1 m; 1...30 ft	0.3...9.1 m; 1...30 ft
Dielectric constant ϵ_r	-	-	-	-	-
Accuracy	±4 mm; ±0.16"	±6 mm; ±0.24"	±6 mm; ±0.24"	±5 mm; ±0.2" or ±0.15% whichever is greater	±5 mm; ±0.2" or ±0.15% whichever is greater
Outputs	mA (HART®)	mA (HART®)	mA (HART®)	mA (HART®)	mA (Modbus RTU)
Power supply	2-wire: 14...36 VDC (14...30 VDC Ex i) 4-wire: 20...72 VDC, 20...253 VAC	2-wire: 14...36 VDC (14...30 VDC Ex i) 4-wire: 20...72 VDC, 20...253 VAC	2-wire: 14...36 VDC (14...30 VDC Ex i) 4-wire: 20...72 VDC, 20...253 VAC	-	-
Housing material	Plastic, aluminium, stainless steel	Plastic, aluminium, stainless steel	Plastic, aluminium, stainless steel	PBT-RF (Valox UV Stabilized) or powder coated aluminium	Fiberglass reinforced Polyester (FRP), sensor: CPVC
Ambient temperature	-40...+80°C; -40...+176°F	-40...+80°C; -40...+176°F	-40...+80°C; -40...+176°F	40...+80°C; -40...+176°F	-40...+80°C; -40...+176°F
Protection category	IP66/67; NEMA4, 4X, 6	IP66/67; NEMA4, 4X, 6	IP66/67; NEMA4, 4X, 6	NEMA 4X (IP-65or IP-66)	Housing: NEMA 4X (IP-66) Sensor rated NEMA 6 (IP-68)
Flange system					
Process connection					
Thread	G1 1/2; 1 1/2" NPT others on request	G2; 2" NPT others on request	-	2" NPT	2" NPT
EN	On request	On request	Compression flange DN100, others on request	Collar flange	Collar flange
ASME	On request	On request	Compression flange 4" 150 lbs	-	-
JIS	-	-	-	-	-
Pressure range					
Process	-0.2...2 barg; -2.9...29 psig	-0.2...2 barg; -2.9...29 psig	-0.2...1 barg; -2.9... 14.5 psig	0.2...3.4 barg; 2.9...50 psig	0.2...3.4 barg; 2.9...50 psig
Temperature range					
Process	-40...+80°C; -40...+176°F	-40...+80°C; -40...+176°F	-40...+80°C; -40...+176°F	40...+80°C; -40...+176°F	40...+80°C; -40...+176°F
Materials					
Wetted parts	PVDF	PVDF	1.4301, UP, 1.4571 (316 Ti)	CPVC	CPVC
Gaskets	EPDM	EPDM	EPDM	FM, CSA, CE, ATEX,	FM, CSA, CE, ATEX
Approvals					
Ex	ATEX, EAC	ATEX, EAC	-	Open Channel Flow Calcs included	Open Channel Flow Calcs included
Miscellaneous	-	-	EAC		



2-wire TDR guided radar for storage or simple process applications	2-wire TDR guided radar for general applications	2-wire TDR guided radar for solid, liquid and interface applications	2-wire TDR guided radar for marine applications
OPTIFLEX 1100 C	OPTIFLEX 2200 C/F	OPTIFLEX 1300 C	OPTIFLEX 4300 C Marine ¹⁾
			
1 GHz	1 GHz	2 GHz	2 GHz
Liquids and solids	Liquids and solids	Liquids and solids	Liquids and solids
+/-	+/-	+/+	+/+
0.7...20 m; 2.3...65.6 ft	0.6...40 m; 2...131 ft	0.2...35 m; 0.7...115 ft	0.2...35 m; 0.7...115 ft
≥1.6	≥1.4 (1.1)	≥1.4 (1.1)	≥1.4 (1.1)
±10 mm; ±0.4"	± 3 mm; ±0.12" (calibration certificate)	±3 mm; ±0.12"	±2 mm; ±0.08"
mA	mA (HART®) FF/PROFIBUS® PA	mA (HART®) optional: 2nd current out- put mA (non-HART®)	mA (HART®)
2-wire: 14...30 VDC	2-wire: 12...30 VDC (non-Ex and Ex i), 16...36 VDC (Ex d)	2-wire: 14...30 VDC (non-Ex and Ex i), 20...36 VDC (Ex d)	2-wire: 14...30 VDC (non-Ex and Ex i)
Aluminium	Aluminium, stainless steel	Aluminium, stainless steel	Stainless steel
-40...+80°C; -40...+176°F	-40...+80°C; -40...+176°F	-40...+80°C; -40...+176°F	-40...+80°C; -40...+176°F
IP 66/67	IP66/67; NEMA4X/6P	IP66/67; NEMA4X/6P	IP66/67; NEMA4X/6P
G3/4 or G1, 3/4" NPT or 1" NPT	G1/2...1 1/2, 1/2...1 1/2" NPT	G1/2...1 1/2, 1/2...1 1/2" NPT	-
Screw-on flanges available as accessories	DN25...150 in PN10...40, DN200 in PN16, 40, others on request	DN25...150 in PN16...100, DN200 in PN16, 40, others on request	DN125 in PN16
Screw-on flanges available as accessories	1...8" in 150 lb/300 lb, others on request	1...4" in 150...900/1500 lb, 6" in 150 lb/300 lb, 8" 150 lb, 1" 2500 lb, others on request	-
Screw-on flanges available as accessories	40...200A in 10K, others on request	40...100A in 10K, others on request	-
-1...16 barg; -14.5...232 psig	-1...40 barg; -14.5...580 psig	-1...100 barg; -14.5...1450 psig, optional 300 barg; 4351 psig	-1...40 barg; -14.5...580 psig
-50...+100°C; -58...+212°F	-50...+150°C; -58...+302°F, optional +300°C; +572°F	-50...+200°C; -58...+392°F, optional +300°C; +572°F	-40...+200°C; -40...+392°F
Cable: stainless steel 1.4404 (316) Coaxial: stainless steel 1.4435/1.4404 (316L)	Stainless steel, Hastelloy®, others on request	Stainless steel 1.4401 (316), 1.4435/1.4404 (316L), Hastelloy® C-22 (2.4602), others on request	Stainless steel
EPDM	FKM/FPM, Kalrez® 6375, EPDM, others on request	FKM/FPM, Kalrez® 6375, EPDM, others on request	FKM/FPM, Kalrez® 6375, EPDM, others on request
CE	ATEX, IECEX, cFMus, NEPSI, INMETRO, EAC	ATEX, IECEX, FM, CSA, NEPSI, INMETRO, EAC, KGS	ATEX
EAC	SIL2, CRN, WHG, NACE	WHG, NACE, CRN	Marine approvals: DNV, ABS, GL, LR, BV, CCS, NK, KR

¹⁾ marketed through KROHNE Marine sales office

	Magnetic bypass level indicator (MLI) for liquid applications (tube inner diameter 38.4 mm / 1 1/2")	Magnetic bypass level indicator (MLI) for liquid and interface applications (tube inner diameter 67.4 mm / 2.65")	BM 26 ADVANCED with welded OPTIWAVE 1010 for liquid applications	BM 26 A with OPTIWAVE 7300 for liquid applications
	BM 26 BASIC/ADVANCED	BM 26 A	BM 26 W1010	BM 26 W7300
				
Measuring principle	Float	Float	Float/radar	Float/radar
Measurable products	Liquids	Liquids	Liquids	Liquids
Level/Interface	+/-	+/+	+/-	+/-
Measuring range	0.3...5.3 m; 1...17.4 ft, longer devices on request	0.3...5.5 m; 1...18 ft, longer devices on request	≤8 m; ≤26.2 ft	0.3...5.4 m; 1...17.7 ft, longer devices on request
Product characteristics	Density: 0.58...2 kg/l; 36.2...124.8 lb/ft ³	Density: ≥0.48...3 kg/l; 30...187.3 lb/ft ³ , lower on request	0.58...1.20 kg/l; 36.21...74.91 lb/ft ³ (if optional float is selected)	Density: ≥0.52 kg/l; ≥32.5 lb/ft ³ , lower on request
Accuracy	±10 mm; ±0.4"	±10 mm; ±0.4"	±5 mm; ±0.2"	±3 mm; ±0.12"
Outputs	mA (HART®), PROFIBUS® PA, FOUNDATION™ fieldbus, switching outputs	mA (HART®), PROFIBUS® PA, FOUNDATION™ fieldbus, switching outputs	mA (HART®)	mA (HART®), switching outputs
Power supply	12...35 VDC	8...35 VDC (non-Ex), 8...30 VDC	2-wire: 14.5...36 VDC (non-Ex and Ex d) 14.5...30 VDC (Ex i)	Radar transmitter – 2-wire: 14...30 VDC (non-Ex and Ex i) 20...36 VDC (Ex d)
Housing material	Aluminium	Aluminium	Aluminium, stainless steel	Aluminium, stainless steel
Ambient temperature	-40...+80°C; -40...+176°F	-40...+85°C; -40...+185°F	-40...+85°C; -40...+185°F	-40...+80°C; -40...+176°F
Protection category	IP68	IP68	IP66/67	IP66/67
Flange system				
Process connection				
Thread	G1/2, 3/4, 1/2, 3/4" NPT	On request	G1/2; 1/2" NPT	On request
EN	DN15...50 in PN40...100	DN15...50 in PN40, optional PN100	DN15...50 in PN40	DN15...50 in PN40
ASME	1/2...2" in 150 lb/300 lb	1/2...2" in 150 lb/300 lb, optional 600 lb	1/2...2" in 150 lb/300 lb	1/2...2" in 150 lb/300 lb
Pressure range				
Process	-1...40 barg; -14.5...580 psig	-1...40 barg; -14.5...580 psig, HP version 100 barg; 1450 psig higher on request	-1...40 barg; -14.5...580 psig	-1...40 barg; -14.5...580 psig, HP version 100 barg; 1450 psig
Temperature range				
Process	-40...+300°C; -40...+572°F	-196...+300°C; -321...+572°F	-40...+150°C; -40...+302°F	-50...+200°C; -58...+392°F
Materials				
Wetted parts	Stainless steel	Stainless steel 1.4404 (316L), 1.4571 (316Ti), PTFE, PVC, PP, PVDF, others on request	Stainless steel, PEEK cone	Stainless steel 1.4404 (316L), others on request
Gaskets	Aramid, PTFE, graphite	Aramid, PTFE, graphite	FKM/FPM, Kalrez® 6375, EPDM, others on request	Aramid, PTFE, graphite
Approvals				
Ex	ATEX, EAC	ATEX, EAC	ATEX, IECEx, NEPSI, EAC (pending)	ATEX, EAC
Miscellaneous	NACE	NACE	NACE	NACE

BM 26 A with OPTIFLEX 2200 for liquid level and/or interface applications	Reference chamber with OPTIFLEX 1300 for liquid level and/or interface applications	The broadband displacer level transmitter for high pressures and temperatures	4-wire potentiometric level transmitter for hygienic applications
BM 26 F2200	RC F1300	BW 25	BM 500
			
TDR	TDR	Displacer	Potentiometric
Liquids	Liquids	Liquids	Liquids and pastes
+/-	+/+	+/+	+/-
0.3...5.5 m; 1...18 ft, longer devices on request	0.3...5.5 m; 1...18 ft, longer devices on request	0.3...5.5 m; 1...18 ft, longer devices on request	0.2...3 m; 0.7...10 ft
Dielectric constant ϵ_r : ≥ 1.4 (1.1)	Dielectric constant ϵ_r : ≥ 1.4 (1.1)	Density: ≥ 0.45 kg/l; ≥ 28.09 lb/ft ³	Electrical conductivity: ≥ 50 μ s/cm
± 3 mm; ± 0.12 "	± 3 mm; ± 0.12 "	<1.5% full scale value	$\pm 0.5\%$
mA (HART®); FF/PROFIBUS® PA	mA (HART®) optional: 2nd current output 4...20 mA (non-HART®)	mA (HART®) switching outputs	mA
2-wire: 12...30 VDC (non-Ex and Ex i), 16...36 VDC (Ex d)	Radar transmitter – 2-wire: 14...30 VDC (non-Ex and Ex i), 20...36 VDC (Ex d)	12...30 VDC	4-wire: 18...36 VDC (non-Ex)
Aluminium, stainless steel	Aluminium, stainless steel	Aluminium, stainless steel	Stainless steel
-40...+80°C; -40...+176°F	-40...+80°C; -40...+176°F	-40...+60°C; -40...+140°F	-20...+60°C; -4...+140°F (compact) -20...+100°C; -4...+212°F (remote)
IP66/67; NEMA4X/6P	IP66/67	IP67; NEMA4X	IP67; NEMA4X
On request	On request	On request	G1 hygienic via adapter system
DN15...50 in PN40	DN15...50 in PN40	DN50...100 in PN16...400	-
1/2...2" in 150 lb/300 lb	1/2...2" in 150 lb/300 lb	2...4" in 150...2500 lb	-
-1...40 barg; -14.5...580 psig	-1...40 barg; -14.5...580 psig, HP version 100 barg, 1450 psig higher on request	-1...400 barg; -14.5...5800 psig, others on request	-1...16 barg; -14.5...232 psig
-50...+300°C; -58...+572°F	-50...+300°C; -58...+572°F	-40...+400°C; -40...+752°F	-20...+140°C; -4...+284°F
Stainless steel, others on request	Stainless steel, others on request	Stainless steel 1.4404 (316L), others on request	Stainless steel 1.4404 (316L)
Aramid, PTFE , graphite	Aramid, PTFE , graphite	-	-
ATEX, EAC	ATEX, EAC	ATEX, EAC	-
NACE	NACE	NACE	3A / FDA, EAC

	Ultra-compact pressure transmitter with flush metallic diaphragm also for hygienic applications	Process pressure transmitter with ceramic diaphragm for pressure and level measurement	Process pressure transmitter with metallic diaphragm also for high pressure ranges and hygienic applications
	OPTIBAR P 2010	OPTIBAR PC 5060	OPTIBAR PM 5060
			
Accuracy (of calibrated span)			
Reference accuracy	<± 0.25% FSO	<± 0.2% <± 0.1% <± 0.05%	<± 0.2% <± 0.1% <± 0.075%
Long-term stability	≤±0.1% within 1 year	≤±0.1% within 5 years	≤±0.1% within 5 years
Max. turn down	n/a	20:1 (100:1)	20:1 (100:1)
Pressure range			
Sensor	Piezoresistive	Ceramic	Piezoresistive, thinfilm
Measurement range	0.1...40 bar; 1.4...580 psi	0.025...100 bar; 0.4...1450.4 psi	0.4...1000 bar; 5.8...14503.8 psi
Line pressure	n.a	n.a.	n.a.
Process connection			
Thread	From G1/2 front flush	From G1/2; 1/2"NPT front flush	From G1/2; 1/2"NPT front flush
Clamp	From 3/4" ISO 2852	From 3/4" ISO 2852	From 1 1/2" ISO 2852
Flange	n.a	From DN25, 1" ASME	From DN25, 1" ASME
Other	Varivent, SMS DIN 11864-1	Varivent, SMS, DIN 11851, PMC, NEUMO Biocontrol, Neumo Bio-Connect, DIN 11864-1	Varivent, SMS, DIN 11851, PMC, NEUMO Biocontrol, Neumo Bio-Connect, DIN 11864-1
Temperature range			
Process	-40...+125°C; -40...+257°F	-40...+150°C; -40...+302°F	-40...+ 105°C; -40...+221°F
Ambient	-40...+85°C; -40...+185°F	-40...+80°C; -40...+176°F	-40...+80°C; -40...+176°F
Configuration			
PC tool	na	Free DTM, also USB interface	Free DTM, also USB interface
Software / HHT	na	Yes - generic and DD	Yes - generic and DD
Local	None - fixed measurement range	With optional display and adjustment module	With optional display and adjustment module
Material			
Housing	316L	DIN housing in 1- or 2-chamber configuration: 316L, aluminium, 316L (electropolished), plastic (PBT)	DIN housing in 1- or 2-chamber configuration: 316L, aluminium, 316L (electropolished), plastic (PBT)
Diaphragm material	316L, Hastelloy® C 276	99.996% Al ₂ O ₃ ceramic	316L , Hastelloy® C276
Communication			
Output	4...20 mA, 0...10 V	4...20 mA, HART®, PA, FF	4...20 mA, HART®, PA, FF
Approvals			
Ex	ATEX / IECEx Ex ia 1G / 1D Canada/US Class 1 Div 1 (pending)	ATEX / IECEx Ex ia, Ex d, Ex d ia Canada/US Class 1 Div 1 (pending)	ATEX / IECEx Ex ia, Ex d; Ex d ia Canada/US Class 1 Div 1 (pending)
Functional safety	-	SIL 2	SIL 2

	Differential pressure transmitter for hydrostatic level measurement with integrated absolute pressure measurement	Submersible level probe with ceramic diaphragm 22 mm / 1" diameter
	OPTIBAR DP 7060 C	OPTIBAR LC 1010
		
Accuracy (of calibrated span)		
Reference accuracy	<± 0.065%	<± 0.25% FSO
Long-term stability	<±0.1% within 5 years	<± 0.1% FSO within 1 year
Max. turn down	100:1	n/a
Pressure range		
Sensor	Piezoresistive	Ceramic
Measurement range	10, 30, 100, 500 mbar, 3, 16 bar; 0.15, 0.4, 1.4, 7.2, 43.5, 232 psi	1...100 mH ₂ O
Line pressure	40, 160, 420 bar; 580.1, 2320.6, 6091.6 psi	n.a.
Process connection		
Thread	1/4"NPT, 1/2"NPT	R1"
Clamp	With OPTIBAR DS	n.a.
Flange	With OPTIBAR DS	DN50
Other	With OPTIBAR DS	Cable: PUR, TPE
Temperature range		
Process	-40...+85°C; -40...+185°F	-40...+85°C; -40...+185°F
Ambient	-40...+80°C; -40...+176°F	-40...+85°C; -40...+185°F
Configuration		
PC tool	Free DTM, also USB interface	na
Software / HHT	Yes - generic and DD	na
Local	With optional display and adjustment module	na
Material		
Housing	DIN housing in 1- or 2-chamber configuration: 316L, aluminium, 316L (electropolished), plastic (PBT)	316L
Diaphragm material	316L, Hastelloy® C276, Monel 400, Tantal, 316L with gold plating	99.96% Al ₂ O ₃ ceramic
Communication		
Output	4...20 mA, HART® 7, PA, FF	4...20 mA
Approvals		
Ex	ATEX / IECEx Ex ia, Ex d, Ex d ia Canada/US Class 1 Div 1 (pending)	ATEX / IECEx Ex ia 1G Canada/US Class 1 Div 1 (pending)
Functional safety	-	-



OPTISWITCH 3X00 C
Vibrating level
switches for solids



OPTISWITCH 5X00 C
Vibrating level switches
for liquids for process and
high temperature / high
pressure applications



OPTISWITCH 4000 C
Vibrating level switch
for liquids for simple
applications



OPTISWITCH 6500 C
Microwave level switch for
hygienic applications



OPTISWITCH 6600 C
Microwave level switch
for hygienic applications



LS 7200
Conductive level switch
for hygienic applications

Level switches

Level switch

Highlights:

- Rugged oscillating fork, high abrasion resistance
- Exactly reproducible switching point without adjustment
- Continuous self-monitoring of correct oscillating frequency, corrosion and cable breakage to the Piezo drive
- Measurement independent of media properties such as viscosity, dielectric constant (ϵ_r) or electrical conductivity
- Not sensitive to adhesions (foam), pressure and temperature changes and external vibrations
- Detection of solids with density $\geq 0.008 \text{ kg/l}$; 0.5 lb/ft^3
- Detection of liquids with density $\geq 0.5 \text{ kg/l}$; 31.2 lb/ft^3
- Wide temperature and pressure range: $-196 \dots +450^\circ\text{C}$; $-321 \dots +842^\circ\text{F}$, max. 160 barg; 2320.6 psig
- Hygienic design with polished surface
- Recurring test as per WHG via test button (with SU 501)
- Detection of solids in water
- Functional safety: up to SIL2 in a single channel architecture, and up to SIL3 in a multiple channel, redundant architecture

The measuring principle

The oscillating element of the OPTISWITCH consists of two paddle-shaped oscillating rods (1), coupled by a membrane (2). Together with the piezo ceramics (3), the rods and the membrane form an electromechanical resonator, which oscillates in the air at its own resonant frequency. The piezos are mechanically mounted and therefore unaffected by sudden temperature variations. When the oscillating rods are covered with fill goods, the oscillating frequency and amplitude change. This results in a frequency reduction of the spring-mass-system.

The frequency change depends on the density of the fill goods and the immersion depth of the oscillating rods. The oscillating frequency of the resonator is detected by a built-in transducer and converted into a switching command when a preset threshold value is exceeded. When the frequency changes only slightly, which is often the case on solids, the switch detects the change in amplitude instead. For solids, the fork is also considerably larger, making the device more sensitive to changes.

Some typical applications are over-fill and dry-run protection. Thanks to its very simple and rugged design, the OPTISWITCH can be used independently of the essential physical and chemical product characteristics in nearly all applications.

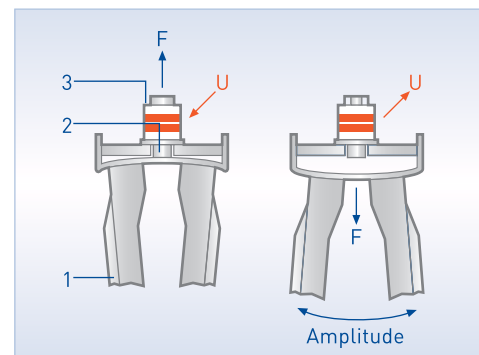

The Piezo effect

Piezo ceramics can be operated in two directions of effect. When an electrical voltage (U) is applied to piezo ceramics, they become physically deformed (F – actuator effect). Conversely, piezo ceramics convert mechanical deformation into an electrical voltage (sensor direction of effect). Both directions of effect are used for vibrating level switches.



OPTISWITCH – The rugged solution for solids and liquids

In the construction materials industry, heavy dust build-up and the mechanical stresses are a challenge for any level switch. This is not a problem for OPTISWITCH: The rugged unit detects the limit in the silo independently of the properties of the bulk goods and reliably warns against overfilling. OPTISWITCH even masters tall, narrow silos due to the product-independent switching point. This is especially beneficial for rapid or recurring changes of bulk goods. Even aerosil and other very light bulk goods must be reliably and safely detected using OPTISWITCH.

Thanks to the exact reproducibility of the switching point and the integrated function monitoring, the OPTISWITCH can be used as overfill protection as per §19 WHG, dry-run protection or pump protection. Neither adhesions on the oscillating fork nor container vibrations have an impact on the measurement.

In high temperature and high pressure applications such as steam boilers, the new OPTISWITCH 5300 applies.

Industries:

- Oil and gas
- Chemical and petrochemical
- Food and beverage
- Pharmaceutical
- Water and wastewater
- Building material
- Plastic processing

Microwave level switches for liquids and solids

Highlights:

- Measurement independent of media properties
- Not sensitive to adhesives and foam
- No blockage of the pipeline, no pressure loss
- Independent of the position and vibration
- Hygienic installation by means of a hygienic process weld sleeve, nearly flush with the front
- Dry-run protection beyond a nominal width of DN15

The measuring principle

The electromagnetic wave measuring process allows for universal use even when the media changes. The electromagnetic wave penetrates the medium and, depending on the respective relative permittivity, a phase shift occurs which is then evaluated.

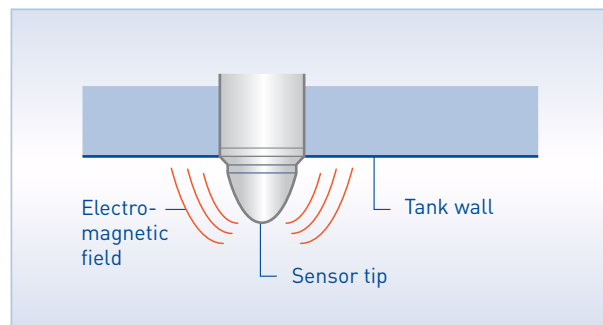

Microwave level switches OPTISWITCH 6500 C/6600 C

Industries:

- Food and beverage
- Pharmaceutical

The microwave level switches of the OPTISWITCH 6500/6600 series handle various media in industries such as food and beverage or pharmaceutical: whether you are dealing with dairy products, toothpaste or cooking oil, the hygienic switches safely and reliably detect the level or serve as dry-run protection. They can also detect liquid/liquid interfaces or even identify the presence of a specific medium. The measurement remains unaffected by foam, condensate or build-up of deposits. Another advantage of this switch family is the very fast response time of the devices and their high immunity to vibrations.



OPTISWITCH 6600 C



OPTISWITCH 6500 C

Conductive level switches

The measuring principle

Conductive probes detect the resistance of the fill goods when the goods cover their electrodes. A small AC current is generated which is evaluated in the electronics unit and converted into switching commands. The switching signal is determined by the length and installation position of the probe and its sensitivity setting.



LS 7200

LS 7200 conductive level switch

Stub, rod or multi-rod electrode? The hygienic conductive probes of the LS 7200 family provide the right solution for any installation situation.

The probe rods are optionally made of stainless steel or coated in order to guarantee their insensitivity to foam and adhesions.

For changing media with widely differing degrees of conductivity, the sensitivity of the probe can be switched over via the control cable.

The hygienic, dead zone-free installation of the LS 7200 series is ensured via a number of different hygienic process connections.

Highlights:

- Optimised flow geometry
- Precise switching point
- Hygienic, dead zone-free installation
- Stub, rod or multi-rod electrodes are available
- Probes can be shortened as needed
- Compact or remote version (electronics in the switchgear cabinet)

Industries:

- Food and beverage
- Pharmaceutical

	Vibrating level switch for solids	Vibrating level switch for liquids for simple applications	Vibrating level switches for liquids for process and high temperature/ high pressure applications
	OPTISWITCH 3X00 C	OPTISWITCH 4000 C	OPTISWITCH 5X00 C
			
Measuring principle	Vibration	Vibration	Vibration
Measurable products	Solids and solids in water	Liquids	Liquids
Level/interface	+/- (solids in water)	+/-	+/-
Standard length	220 mm; 8.7"	66 mm; 2.6"	66 mm; 2.6"
Measuring range	-	-	-
Length with tube extension	0.3...6 m; 11.8"...20 ft	-	0.08...6 m; 0.26...20 ft
Length with cable extension	0.3...80 m; 11.8"...262.4 ft	-	-
Product characteristics	Density: ≥0.008 kg/l; ≥0.5 lb/ft ³	Density: ≥0.7 kg/l; ≥43.7 lb/ft ³	Density: ≥0.5 kg/l; ≥31.2 lb/ft ³
Accuracy	-	-	-
Outputs	Relay, transistor, contactless switch, 2-wire output	Transistor, contactless switch	Relay, transistor, contactless switch, 2-wire output, NAMUR
Power supply	Relay and contactless switch: 20...253 VAC/DC transistor output: 10...55 VDC	Contactless switch: 20...253 VAC/DC transistor output: 10...55 VDC	Relay and contactless switch: 20...253 VAC/DC transistor output: 10...55 VDC
Housing material	Plastic, aluminium, stainless steel	Plastic, stainless steel	Plastic, aluminium, stainless steel
Ambient temperature	-40...+70°C; -40...+158°F	-40...+70°C; -40...+158°F	-40...+70°C; -40...+158°F
Protection category	IP66/67; NEMA4, 4X, 6	IP65/67; NEMA4, 4X, 6	IP66/67; NEMA4, 4X, 6
Flange system			
Process connection			
Thread	G1 1/2; 1 1/2" NPT	G1/2, 1; 3/4", 1" NPT	G3/4, 1; 3/4", 1" NPT
EN 1092-1	On request	-	≥DN25 in PN16...64
ASME B 16.5	On request	-	≥1" in 150...300 lb
Pressure range			
Process	-1...16 barg; -14.5...232 psig	-1...64 barg; -14.5...928.2 psig	-1...160 barg; -14.5...2320.6 psig
Temperature range			
Process	-50...+250°C; -58...+482°F	-40...+150°C; -40...+302°F	-196...+450°C; -321...+842°F
Materials			
Wetted parts	Stainless steel 1.4435/1.4404 (316L), 1.4462 (318S13)	Stainless steel 1.4435/1.4404 (316L), others on request	Stainless steel 1.4571 (316Ti), Hastelloy® C, enamel, ECTFE, PFA, Inconel 718
Gasket	Klingsil® C-4400 (for thread)	Klingsil® C-4400 (process seal)	Klingsil® C-4400 (for thread)
Approvals			
Ex	ATEX, FM, CSA, EAC	-	ATEX, FM, CSA, EAC
Miscellaneous	SIL	§19 WHG, EAC	§19 WHG, shipping approvals, SIL

	Microwave level switches for hygienic applications	Conductive level switch for hygienic applications
	OPTISWITCH 6500/6600 C	LS 7200
		
Measuring principle	Microwave	Conductive
Measurable products	Liquids and solids	Liquids
Level/interface	+	+/-
Standard length	18 mm; 0.7"	0.2...1.5 m; 0.66...4.92 ft
Measuring range	-	min. 50 mm; 2"
Length with tube extension	100/250 mm; 3.9/9.8"	-
Length with cable extension	-	-
Product characteristics	Dielectric constant (ϵ_r) ≥ 1.5	Conductive products
Accuracy	-	-
Outputs	Transistor, NPN/PNP	Transistor
Power supply	12...36 VDC, max. 70 mA	18...36 VDC, max. 10 mA
Housing material	Stainless steel	Stainless steel
Ambient temperature	-40...+85°C; -40...+185°F	-20...+60°C; -4...+140°F
Protection category	IP67; NEMA4, 4X	IP67; NEMA4, 4X
Flange system		
Process connection		
Thread	G1/2	G1/2, 1
EN 1092-1	-	-
ASME B 16.5	-	-
Pressure range		
Process	-1...16 barg; -14.5...232 psig	-1...16 barg; -14.5...232 psig
Temperature range		
Process	-20...+85°C; -4...+185°F	-20...+140°C; -4...+284°F
Materials		
Wetted parts	Stainless steel 1.4404 (316L)	Stainless steel 1.4404 (316L)
Gasket	-	-
Approvals		
Ex	ATEX, EAC	-
Miscellaneous	3A / FDA	3A / FDA, EAC

Communication technology

Drivers · Protocols · Configuration · Diagnostics

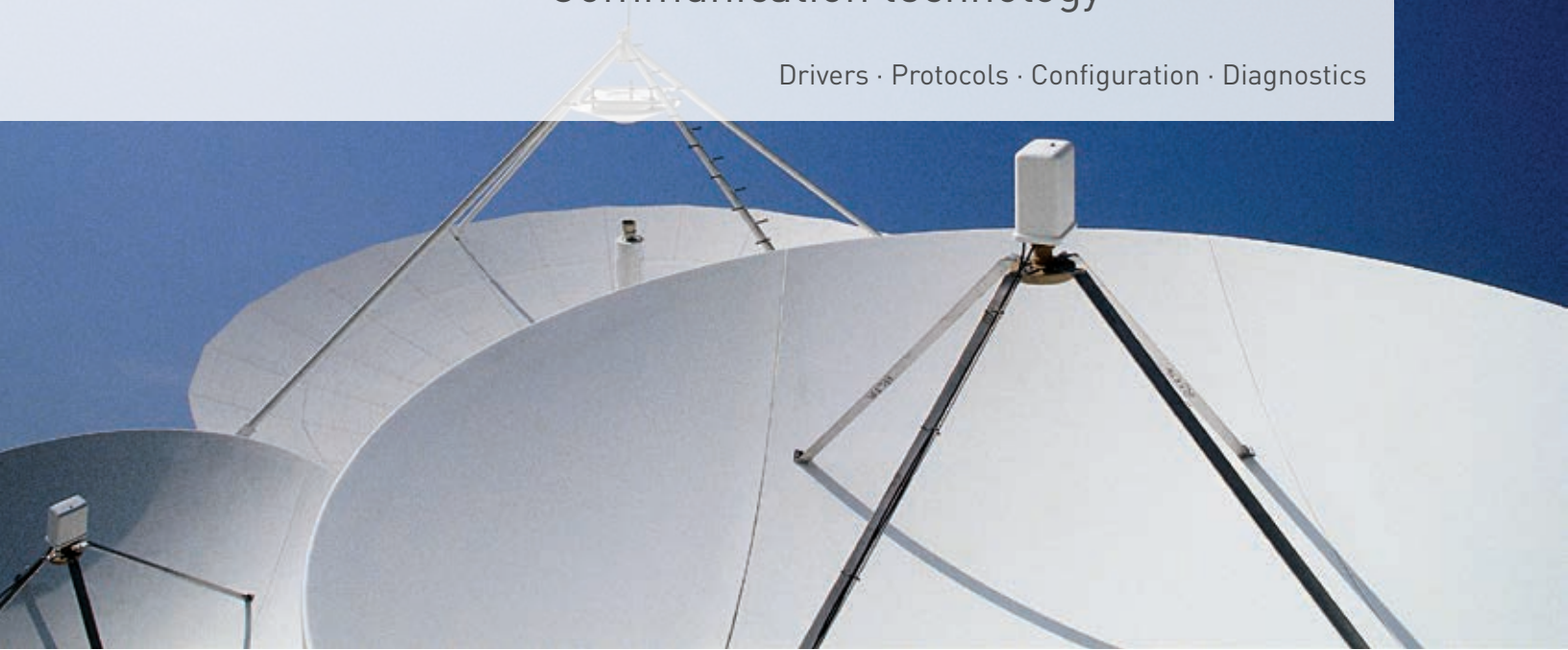

Open for the future

PACTware™ and DTMs

PACTware™ is a manufacturer-independent tool based on FDT technology, providing device configuration and operation. It is free of charge.

DTMs are drivers for FDT-based systems. KROHNE DTMs are also available free of charge, without licence and without any functional restrictions.

KROHNE is committed to making communication convenient. Which is why our field devices communicate reliably with controllers, control systems and PCs, and can also be used for a variety of control and regulating tasks. They meet all of the prerequisites for integration into modern plant asset management systems, based on integration technologies such as DD/EDD and FDT/DTM.

We are a longstanding member of PACTware™ and the FDT Group®. Since 2003, we have made DTMs available for our field devices with HART®, PROFIBUS® or FOUNDATION™ fieldbus interfaces.

For remote monitoring of applications such as water metering, KROHNE has developed a GSM-based solution for online data transmission and logging.

So you will always have the information you need conveniently close to hand.



Clear and fast access to process and device data from any level

KROHNE DTMs are available for many field devices with HART®, FOUNDATION™ fieldbus or PROFIBUS® communication interfaces. They can be integrated into all FDT frame applications.

To assure conformity with the FDT standard, KROHNE DTMs are certified by the FDT Group after certification tests at the KROHNE FDT DTM Test Site, accredited in 2014. In addition, intensive interoperability tests with frames of major host system suppliers are performed.

KROHNE DTMs do not require any licence, providing full functionality free of charge. Next to standard operating features, they provide additional information for commissioning and application engineers.

For example, the DTM for the MFC 400 mass flow converter features clear and configurable diagnostics according to NAMUR recommendations NE 107, and an intuitive layout for fast access to the most used functions. DTMs for level devices are enhanced by fully configurable parameterisation screens for easy commissioning.

Together with PACTware™, KROHNE DTMs come alongside the device on a CD and can also be downloaded from KROHNE Download Centre at www.krohne.com



Configuration of OPTITEMP TT 51 temperature transmitter via PACTware™



Diagnostic data is categorized or can be user-mapped into five categories according to the severity and ease reactions by the operator. Detailed configuration enables predictive maintenance.

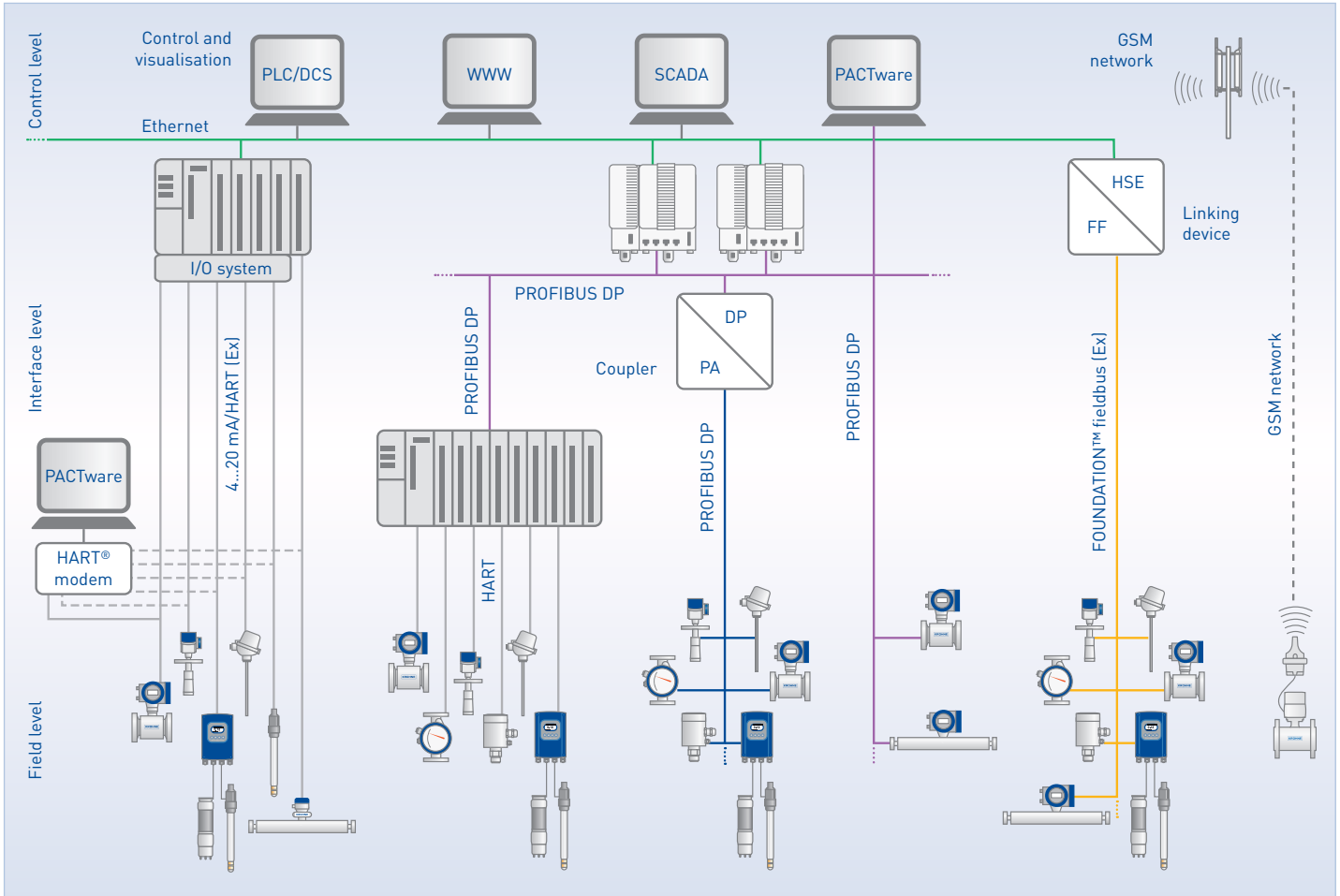

KROHNE services

Engineering services · Online tools and services · Maintenance services · Quality · Training and seminars · Calibration



Beyond the highest requirements

For us, service starts at our first contact with you and lasts as long as the life of our systems installed at your plant.

Quality and reliability are key to maintaining the highest service standards. All KROHNE feeder factories are ISO 9001 certified. In fact, long before ISO 9000 existed, KROHNE was already manufacturing to the highest industrial standards. Now certification exists in every factory to demonstrate that we not only fulfil ISO requirements but have passed the ISO certification procedure every three years since the standard was introduced.

But it's not simply a one-way process. We actively encourage companies like yours to participate in our research and development activities. Many of our products that are today considered the pinnacle of excellence were developed in cooperation with our customers.

Engineering services through all project stages

- Project management
- Control and asset management systems in project concept phase
- Basic engineering based on the specification required by the user
- Detail engineering phase
- Commissioning services
- On-site start-up and commissioning
- Product training (on-site)
- Calibration services

Proven quality

Before shipping, every meter is thoroughly inspected. This rigorous programme of specific measurements, tests and factory inspections is called KROHNE proved.

So, if you install and operate any KROHNE product by following our operating instructions correctly, problems shouldn't occur. If they do, we will provide you with all the technical support and service you need.

Choose from maintenance and service contracts tailored to suit all business sizes and needs:

- Spare parts and consumables
- Field service and on-site repair
- Returns
- Workshop repair
- Helpdesk

KROHNE Academy and KROHNE Academy online

The KROHNE Academy is a series of seminars organised in collaboration with leading automation companies aimed at plant engineers, operators and contractors across the process industries. It brings industry experts together to provide an insight into the various technologies, industrial standards and procedures that plant operators can find themselves faced with.

Taking place in various countries, KROHNE Academy seminars address key operating issues, from plant safety to ways of increasing plant efficiency and controlling costs, and show possible solutions. They also provide an ideal opportunity for you to speak to the experts and benefit from their vast application knowledge.

Learn more about KROHNE Academy at www.krohne.com

KROHNE Academy online is a free eLearning platform that contains audio-enhanced, interactive Web Based Trainings. As with its on-site seminars, the online KROHNE academy learning material is vendor-agnostic and not specific to individual products and/or industries. The main focus of each course is on a measurement technology such as Variable Area, Vortex, Ultrasonic or Mass flow or to a more general topic such as the basics of gas measurement or pipeline leak detection.

Register now for free and start your training at <http://academy-online.krohne.com>

Please check www.krohne.com for your local service contact.

Additional online services:

(Find them at www.krohne.com)

- **Configure It**
Configure It is a highly advanced online configuration tool for standard devices offering free 2D/3D CAD data of KROHNE flow devices for planning engineers. It enables you to configure any KROHNE product to handle your application in a few simple steps.
- **KROVASYS 4**
Selection and calculation tool for variable area flowmeters.
- **Planning tool for water & wastewater industry**
The planning tool for wastewater treatment plants as well as water and wastewater applications for generating tender documents covering flow, level, analysis, pressure and temperature.
- **PiCK**
Get any information related to your KROHNE product from our dedicated online resource PiCK. Just enter your serial number, and key material like manuals, Quick Starts and calibration documents is at your fingertips.

Calibration from KROHNE: Certainty you can count on

Calibration is one of KROHNE's core areas of expertise. If you buy a KROHNE product, you will get a measuring device that performs most accurate with low uncertainty under real process conditions.

To achieve this, we operate more than 120 calibration facilities for volume flow, mass flow, level, temperature, density and pressure to (wet-)calibrate any device we manufacture. For example, every flowmeter is wet-calibrated using water or air as standard before leaving our facilities.

We can also provide customer specific calibration such as:

- Carry out multipoint calibrations
- Vary different parameters such as temperatures, viscosities, pressures etc.
- Use the actual medium or similar
- Build or emulate customer-specific flow geometries
- Use piping provided by the customer

For calibration we only use direct comparison of measurands (e.g. we calibrate our Coriolis mass flowmeters with a gravimetric weighing system). Our calibration rigs are the most accurate used in measuring device production worldwide: the accuracy of the reference is usually 5 to 10 times better than that of the meter under test.

The world's most precise volumetric calibration rig for flowmeters up to DN 3000/120"

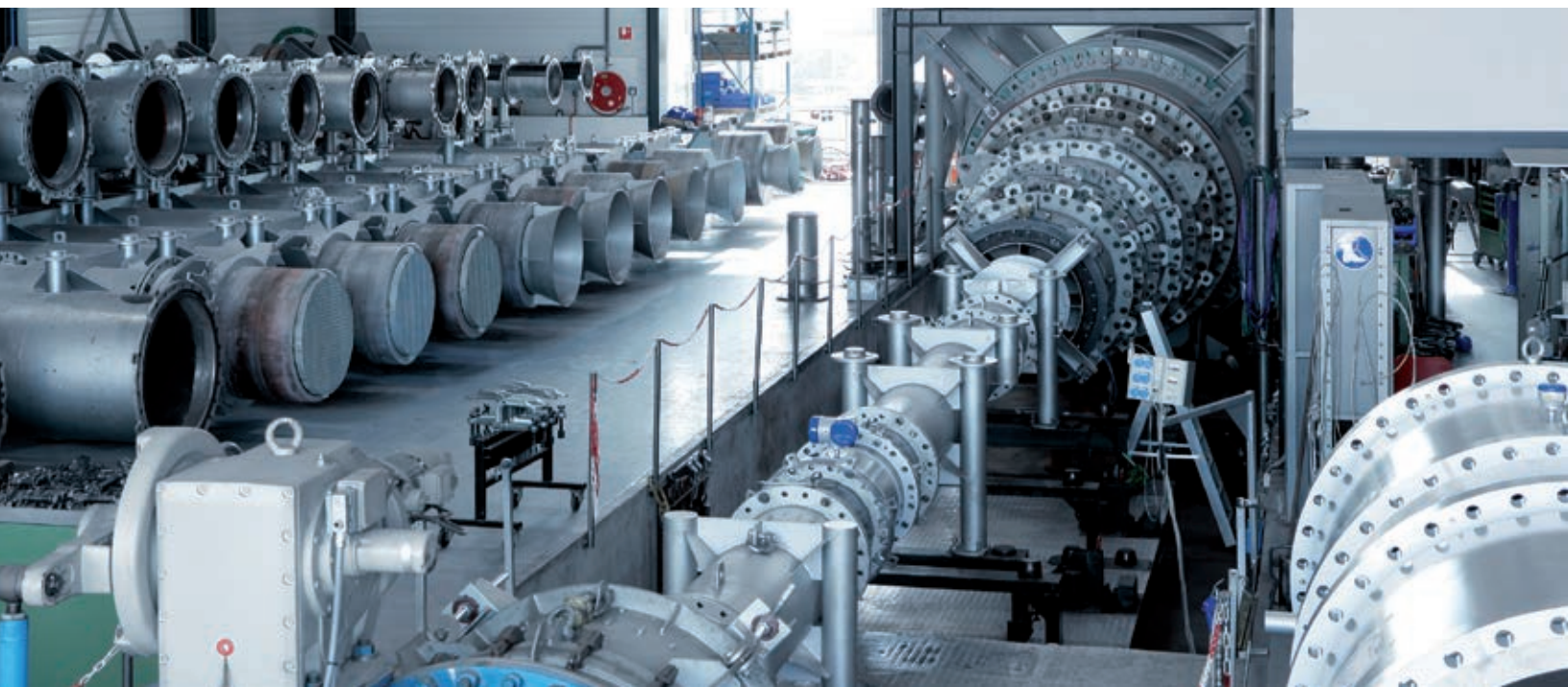



Calibration rig for FMCW level transmitters

Volumetric piston prover

This goes for small as well as for very large sizes: KROHNE operates the world's most precise volumetric calibration rig for flowmeters up to DN 3000/120" with a certified accuracy of 0.013 %. The reference vessel is a 44 m/144 ft high tank containing almost ½ million litres/132,000 gal (US) of water which allows for a maximum flow rate of 30,000 m³/h/7,925,000 gal (US)/h.

Certified technology for fiscal & custody transfer applications

Our meters can be calibrated and certified according to various standards such as OIML, API, Measuring Instruments Directive (MI-001, 002, 004, 005), GOST, etc. The standards we use for calibration are ISO/IEC 17025 accredited and traceable to international or national standards. Regular inspections by national metrology institutes, round robin tests and alignments with national and international metrological standards according to ISO 9000 and EN 45000 guarantee the quality and comparability of our calibration rigs. Staff performing the calibrations are trained and given regular re-trainings to ensure quality and continuity.



KROHNE – Process instrumentation and Measurement solutions

- Flow
- Level
- Temperature
- Pressure
- Process analysis
- Services

Contact

KROHNE North America
KROHNE, Inc.
7 Dearborn Road
Peabody, MA 01960
USA
Tel.: 800-FLOWING (356-9464)
Tel.: 978-535-6060 in MA
Fax: 978-535-1720
info@krohne.com

Global companies and representatives

The current list of all
KROHNE contacts and
addresses can be found at:
www.krohne.com

